

# Service Manual

## Air-to-Water Heatpump

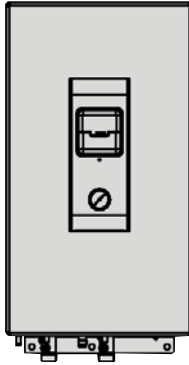

**Indoor Unit**  
 WH-SDC09F3E8  
 WH-SDC12F9E8  
 WH-SDC14F9E8  
 WH-SDC16F9E8

**Outdoor Unit**  
 WH-UD09FE8  
 WH-UD12FE8  
 WH-UD14FE8  
 WH-UD16FE8

**Destination**  
**Europe**

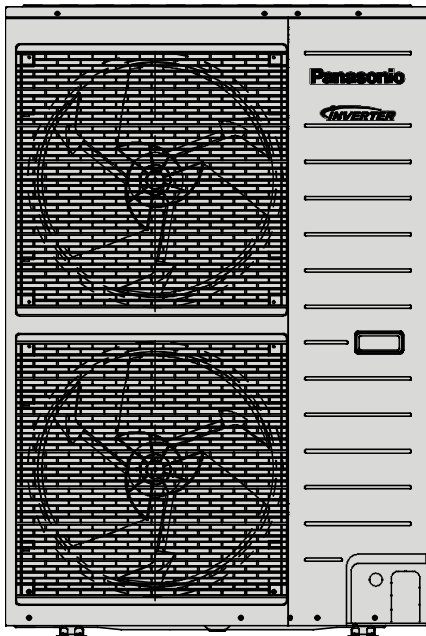

### WARNING

This service information is designed for experienced repair technicians only and is not designed for use by the general public. It does not contain warnings or cautions to advise non-technical individuals of potential dangers in attempting to service a product. Products powered by electricity should be serviced or repaired only by experienced professional technicians. Any attempt to service or repair the products dealt with in this service information by anyone else could result in serious injury or death.

### IMPORTANT SAFETY NOTICE

There are special components used in this equipment which are important for safety. These parts are marked by  in the Schematic Diagrams, Circuit Board Diagrams, Exploded Views and Replacement Parts List. It is essential that these critical parts should be replaced with manufacturer's specified parts to prevent shock, fire or other hazards. Do not modify the original design without permission of manufacturer.

### PRECAUTION OF LOW TEMPERATURE

In order to avoid frostbite, be assured of no refrigerant leakage during the installation or repairing of refrigerant circuit.



# TABLE OF CONTENTS

<b>1. Safety Precautions</b> .....	<b>4</b>
<b>2. Specifications</b> .....	<b>7</b>
2.1 WH-SDC09F3E8 WH-UD09FE8 .....	7
2.2 WH-SDC12F9E8 WH-UD12FE8 .....	10
2.3 WH-SDC14F9E8 WH-UD14FE8 .....	13
2.4 WH-SDC16F9E8 WH-UD16FE8 .....	16
<b>3. Features</b> .....	<b>19</b>
<b>4. Location of Controls and Components</b> .....	<b>20</b>
4.1 Indoor Unit .....	20
4.2 Outdoor Unit.....	28
<b>5. Dimensions</b> .....	<b>29</b>
5.1 Indoor Unit .....	29
5.2 Outdoor Unit.....	30
<b>6. Refrigeration and Water Cycle Diagram</b> .....	<b>31</b>
<b>7. Block Diagram</b> .....	<b>33</b>
7.1 WH-SDC09F3E8 WH-UD09FE8 .....	33
7.2 WH-SDC12F9E8 WH-UD12FE8 WH-SDC14F9E8 WH-UD14FE8 WH-SDC16F9E8 WH-UD16FE8 .....	34
<b>8. Wiring Connection Diagram</b> .....	<b>35</b>
8.1 Indoor Unit .....	35
8.2 Outdoor Unit.....	37
<b>9. Electronic Circuit Diagram</b> .....	<b>38</b>
9.1 Indoor Unit .....	38
9.2 Outdoor Unit.....	40
<b>10. Printed Circuit Board</b> .....	<b>41</b>
10.1 Indoor Unit .....	41
10.2 Outdoor Unit.....	43
<b>11. Installation Instruction</b> .....	<b>45</b>
11.1 Select the Best Location .....	45
11.2 Indoor/Outdoor Unit Installation Diagram .....	45
11.3 Indoor Unit .....	46
11.4 Outdoor Unit.....	51
<b>12. Installation Instruction</b> .....	<b>55</b>
12.1 Select the Best Location .....	55
12.2 Indoor/Outdoor Unit Installation Diagram .....	55
12.3 Indoor Unit .....	56
12.4 Outdoor Unit.....	61
<b>13. Operation and Control</b> .....	<b>65</b>
13.1 Basic Function .....	65
13.2 Water Pump .....	86
13.3 Pump Down Operation [Service Mode: 01] .....	88
13.4 Flow Switch.....	88
13.5 Indoor Unit Safety .....	89
13.6 Auto Restart Control .....	89
13.7 Indication Panel .....	89
13.8 Indoor Back-Up Heater Control .....	90
13.9 Tank Booster Heater Control .....	91
13.10 Base Pan Heater Control (Optional).....	91
13.11 Sterilization Mode .....	92
13.12 Quiet Operation.....	92
13.13 Anti Freeze Control .....	93
13.14 Solar Operation (Optional).....	94
13.15 External Room Thermostat Control (Optional) .....	98
13.16 Three Ways Valve Control .....	99
13.17 Two Ways Valve Control.....	99
13.18 External OFF/ON Control .....	100
13.19 Holiday Mode .....	101
13.20 Dry Concrete Function.....	101
<b>14. Protection Control</b> .....	<b>102</b>
14.1 Protection Control for All Operations .....	102
14.2 Heat Exchanger (HEX) Protection Control .....	104
14.3 Protection Control for Heating Operation..	105
14.4 Protection Control for Cooling Operation..	107
<b>15. Servicing Guide</b> .....	<b>108</b>
15.1 How to Take Out Front Plate .....	108
15.2 How to Take Out Side Cabinet .....	108
15.3 Test Run .....	108
15.4 Proper Pump Down Procedure [SERVICE MODE: 01] .....	108
15.5 How to Adjust Water Flow Rate [SERVICE MODE: 02] .....	109
15.6 Expansion Vessel Pre Pressure Checking .....	109
15.7 How to Unlock Cool Mode .....	109
15.8 Dry Concrete [SERVICE MODE: 03].....	110
15.9 EEPROM Factory Default Data Setup Procedure .....	110
<b>16. Maintenance Guide</b> .....	<b>111</b>
<b>17. Troubleshooting Guide</b> .....	<b>113</b>
17.1 Refrigeration Cycle System .....	113
17.2 Relationship between the Condition of the Air- to-Water Heatpump Indoor and Outdoor Units and Pressure and Electric Current.....	114
17.3 Breakdown Self Diagnosis Function .....	115
17.4 Error Codes Table.....	116
17.5 Self-diagnosis Method .....	118
<b>18. Disassembly and Assembly Instructions</b> ...	<b>155</b>
18.1 To Remove Front Plate.....	155
18.2 To Remove Cabinet.....	155
18.3 To Remove Pressure Gauge .....	156
18.4 To Remove Control Panel .....	156
18.5 To Remove RCCB .....	157
18.6 To Remove Transformer and Electronic Controller Board.....	158
18.7 To Remove Pressure Relief Valve, Flow Switch and Air Purge Valve .....	158
18.8 To Remove Water Pump and Bottle Complete .....	159
<b>19. Technical Data</b> .....	<b>161</b>
19.1 Operation Characteristics .....	161
19.2 Heating Capacity Table.....	185
19.3 Cooling Capacity Table.....	186
<b>20. Exploded View and Replacement Parts List</b>	<b>187</b>
20.1 Indoor Unit .....	187

20.2 Outdoor Unit .....190

# 1. Safety Precautions



- Read the following “SAFETY PRECAUTIONS” carefully before perform any servicing.
- Electrical work must be installed or serviced by a licensed electrician. Be sure to use the correct rating and main circuit for the model installed.
- The caution items stated here must be followed because these important contents are related to safety. The meaning of each indication used is as below. Incorrect installation or servicing due to ignoring of the instruction will cause harm or damage, and the seriousness is classified by the following indications.

 <b>WARNING</b>	This indication shows the possibility of causing death or serious injury.
 <b>CAUTION</b>	This indication shows the possibility of causing injury or damage to properties.

- The items to be followed are classified by the symbols:

	This symbol denotes item that is PROHIBITED from doing.
---	---

- Carry out test run to confirm that no abnormality occurs after the servicing. Then, explain to user the operation, care and maintenance as stated in instructions. Please remind the customer to keep the operating instructions for future reference.

 <b>WARNING</b>	
1.	Do not modify the machine, part, material during repairing service.
2.	If wiring unit is supplied as repairing part, do not repair or connect the wire even only partial wire break. Exchange the whole wiring unit.
3.	Do not wrench the fasten terminal. Pull it out or insert it straightly.
4.	Engage dealer or specialist for installation and servicing. If installation of servicing done by the user is defective, it will cause water leakage, electrical shock or fire.
5.	Install according to this installation instructions strictly. If installation is defective, it will cause water leakage, electric shock or fire.
6.	Use the attached accessories parts and specified parts for installation and servicing. Otherwise, it will cause the set to fall, water leakage, refrigerant leakage, fire or electrical shock.
7.	Install at a strong and firm location which is able to withstand the set's weight. If the strength is not enough or installation is not properly done, the set will drop and cause injury.
8.	Do not install outdoor unit near handrail of veranda. When installing outdoor unit at veranda of high rise building, child may climb up to outdoor unit and cross over the handrail and causing accident. 
9.	For electrical work, follow the local national wiring standard, regulation and the installation instruction. An independent circuit and single outlet must be used. If electrical circuit capacity is not enough or defect found in electrical work, it will cause electrical shock or fire.
10.	This equipment must be properly earthed. Earth line must not be connected to gas pipe, water pipe, earth of lightning rod and telephone. Otherwise, it may cause electric shock in case equipment breakdown or insulation breakdown.
11.	Do not use joint cable for indoor/outdoor connection cable. Use specified indoor/outdoor connection cable, refer to Installation Instructions <b>CONNECT THE CABLE TO THE INDOOR UNIT</b> and connect tightly for indoor/outdoor connection. Clamp the cable so that no external force will be acted on the terminal. If connection or fixing is not perfect, it will cause heat up or fire at the connection.
12.	When install or relocate Air to Water Heatpump indoor/outdoor unit, do not let any substance other than the specified refrigerant, eg. air etc. mix into refrigerant cycle (piping). Mixing of air etc. will cause abnormal high pressure in refrigeration cycle and result in explosion, injury etc.
13.	This is a R410A model, when connecting the piping, do not use any existing (R22) pipes and flare nuts. Using such same may cause abnormally high pressure in the refrigeration cycle (piping), and possibly result in explosion and injury. Use only R410A refrigerant. Thickness of copper pipes used with R410A must be more than 0.8 mm. Never use copper pipes thinner than 0.8 mm. It is desirable that the amount of residual oil is less than 40 mg/10 m. 
14.	During installation, install the refrigerant piping properly before run the compressor. Operation of compressor without fixing refrigeration piping and valves at opened condition will cause suck-in of air, abnormal high pressure in refrigeration cycle and result in explosion, injury etc.
15.	During pump down operation, stop the compressor before remove the refrigeration piping. Removal of refrigeration piping while compressor is operating and valves are opened condition will cause suck-in of air, abnormal high pressure in refrigeration cycle and result in explosion, injury etc.
16.	After completion of the installation servicing confirm there is no leakage of refrigerant gas. It may generate toxic gas when the refrigerant contacts with fire.
17.	Ventilate the room if there is refrigerant gas leakage during operation. Extinguish all fire sources if present. It may cause toxic gas when the refrigerant contacts with fire.
18.	Only use the supplied or specified installation parts, else, it may cause unit vibrate loose, water/refrigerant leakage, electrical shock or fire.

 **WARNING**

19. The unit is only for use in a closed portable water system. Utilization in an open water circuit or non-portable water circuit, may lead to excessive corrosion of the water piping and risk of incubating bacteria colonies, particularly Legionella, in water.	
20. Do not insert your fingers or other objects into the unit, high speed rotating fan may cause injury.	⊘
21. Do not dismantle refrigerant piping using pipe wrench. It might deform the piping and cause the unit to malfunction.	⊘
22. Select a location where in case of water leakage, the leakage will not cause damage to other properties.	
23. Do not locally purchase electrical parts of the product for the purpose of installation, service, maintenance and etc. They might cause electrical shock or fire.	⊘
24. Do not branch the power from terminal block to heater tape. Overloaded terminal block will cause electrical shock or fire.	⊘
25. Installation or servicing work. It may need two people to carry out the installation or servicing work.	⊘
26. Do not use unspecified cord, modified cord, joint cord or extension cord for power supply cord. Do not share the single outlet with other electrical appliances. Poor contact, poor insulation or over current will cause electrical shock or fire.	
27. Tighten the flare nut with torque wrench according to specified method. If the flare nut is over-tightened, after a long period, the flare may break and cause refrigerant gas leakage.	

 **CAUTION**

1. Do not install the air-to-water heatpump indoor unit and outdoor unit at place where leakage of flammable gas may occur. In case gas leaks and accumulates at surrounding of the unit, it may cause fire.	⊘
2. Carry out drainage piping as mentioned in installation instructions. If drainage is not perfect, water may enter the room and damage the furniture.	
3. It may need two persons to carry out the installation work. The weight of indoor/outdoor unit might cause injury if carried by one person.	
4. Do not touch outdoor unit air inlet and aluminium fin. It may cause injury.	⊘
5. Select an installation location which is easy for maintenance.	
6. Pb free solder has a higher melting point than standard solder; typically the melting point is 50°F - 70°F (30°C - 40°C) higher. Please use a high temperature solder iron. In case of the soldering iron with temperature control, please set it to 700 ± 20°F (370 ± 10°C). Pb free solder will tend to splash when heated too high (about 1100°F/600°C).	
7. Power supply connection to indoor unit. <ul style="list-style-type: none"> <li>1. Power supply point should be in easily accessible place for power disconnection in case of emergency.</li> <li>2. Must follow local national wiring standard, regulation and this installation instruction.</li> <li>3. Strongly recommended to make permanent connection to a circuit breaker. <ul style="list-style-type: none"> <li>- Power Supply 1: Use approved 20A 4-poles circuit breaker with a minimum contact gap of 3.0 mm.</li> <li>- Power Supply 2: Use approved 15/16A 2-poles circuit breaker with a minimum contact gap of 3.0 mm.</li> </ul> <p style="text-align: center;">(Only applicable for WH-SDC09F3E8)</p> <p style="text-align: center;">or</p> <p style="text-align: center;">Use approved 20A 4-poles circuit breaker with a minimum contact gap of 3.0 mm.</p> <p style="text-align: center;">(Only applicable for WH-SDC12F9E8)</p> </li> </ul>	
<b>WH-SDC14F9E8 WH-UD14FE8 WH-SDC16F9E8 WH-UD16FE8 only</b>	
8. Power supply connection to indoor unit. <ul style="list-style-type: none"> <li>1. Power supply point should be in easily accessible place for power disconnection in case of emergency.</li> <li>2. Must follow local national wiring standard, regulation and this installation instruction.</li> <li>3. Strongly recommended to make permanent connection to a circuit breaker. <ul style="list-style-type: none"> <li>- Power Supply 1: Use approved 20A 4-poles circuit breaker with a minimum contact gap of 3.0 mm.</li> <li>- Power Supply 2: Use approved 20A 4-poles circuit breaker with a minimum contact gap of 3.0 mm.</li> </ul> </li> </ul>	
9. Do not release refrigerant during piping work for installation, servicing, re-installation and during repairing a refrigeration parts. Take care of the liquid refrigerant, it may cause frostbite.	⊘
10. Do not install this appliance in a laundry room or other high humidity location. This condition will cause rust and damage to the unit.	⊘
11. Make sure the insulation of power supply cord does not contact to hot part (i.e. refrigerant piping, water piping) to prevent from insulation failure (melt).	⊘
12. Do not sit, step or place anything on the unit, you may fall down accidentally.	⊘
13. Do not touch the sharp aluminum fins or edges of metal parts. If you are required to handle sharp parts during installation or servicing, please wear hand glove. Sharp parts may cause injury.	⊘

 **CAUTION**

14. After installation, check the water leakage condition in connection area during test run. If leakage occur, it will cause damage to other properties.
15. The unit described in this manual is designed for use in a closed water system only. Utilization in an open water circuit may lead to excessive corrosion of the water piping. 

## 2. Specifications

### 2.1 WH-SDC09F3E8 WH-UD09FE8

Item		Unit	Outdoor Unit		
Performance Test Condition			EN 14511		
Cooling Capacity	Condition (Ambient/Water)		A35W7		
	kW		7.00		
	BTU/h		23900		
	kcal/h		6020		
Cooling EER	W/W		3.17		
	kcal/hW		2.72		
Heating Capacity	Condition (Ambient/Water)		A7W35	A2W35	
	kW		9.00	9.00	
	BTU/h		30700	30700	
	kcal/h		7740	7740	
Heating COP	W/W		4.84	3.59	
	kcal/hW		4.16	3.08	
Noise Level	Condition (Ambient/Water)		A35W7	A7W35	A2W35
	dB (A)		Cooling: 49	Heating: 49	—
	Power Level dB		Cooling: 67	Heating: 66	—
Air Flow	m <sup>3</sup> /min (ft <sup>3</sup> /min)		Cooling: 89.5 (3160) Heating: 76.8 (2710)		
Refrigeration Control Device			Expansion Valve		
Refrigeration Oil		cm <sup>3</sup>	FV50S (1200)		
Refrigerant (R410A)		kg (oz)	2.55 (90.0)		
Dimension	Height	mm (inch)	1340 (52-3/4)		
	Width	mm (inch)	900 (35-7/16)		
	Depth	mm (inch)	320 (12-19/32)		
Net Weight		kg (lbs)	108 (238)		
Pipe Diameter	Liquid	mm (inch)	9.52 (3/8)		
	Gas	mm (inch)	15.88 (5/8)		
Standard Length		m (ft)	7 (23.0)		
Pipe Length Range		m (ft)	3 (9.8) ~ 30 (98.4)		
I/D & O/D Height Difference		m (ft)	20 (65.6)		
Additional Gas Amount		g/m (oz/ft)	50 (0.5)		
Refrigeration Charge Less		m (ft)	10 (32.8)		
Compressor	Type		Hermetic Motor / Rotary		
	Motor Type		Brushless (4-poles)		
	Rated Output	kW	4.30		
Fan	Type		Propeller Fan		
	Material		PP		
	Motor Type		DC (8-poles)		
	Input Power	W	—		
	Output Power	W	60		
	Fan Speed	rpm	Cooling: 550 (Top), 590 (Bottom) Heating: 490 (Top), 530 (Bottom)		
Heat Exchanger	Fin material		Aluminium (Pre Coat)		
	Fin Type		Corrugated Fin		
	Row × Stage × FPI		2 × 51 × 18		
	Size (W × H × L)	mm	903.7 × 1295.4 × 38.1		

Item		Unit	Outdoor Unit		
Power Source (Phase, Voltage, Cycle)		∅	Three		
		V	400		
		Hz	50		
Input Power		Condition (Ambient/Water)	A35W7	A7W35	A2W35
		kW	Cooling: 2.21	Heating: 1.86	Heating: 2.51
Maximum Input Power For Heatpump System		kW	4.94		
Power Supply 1 : Phase (∅) / Max. Current (A) / Max. Input Power (W)			3∅ / 11.8 / 7.94k		
Power Supply 2 : Phase (∅) / Max. Current (A) / Max. Input Power (W)			1∅ / 13.0 / 3.00k		
Power Supply 3 : Phase (∅) / Max. Current (A) / Max. Input Power (W)			— / — / —		
Starting Current		A	3.4		
Running Current		Condition (Ambient/Water)	A35W7	A7W35	A2W35
		A	Cooling: 3.4	Heating: 2.8	Heating: 3.8
Maximum Current For Heatpump System		A	7.5		
Power Factor Power factor means total figure of compressor and outdoor fan motor.		%	Cooling: 95 Heating: 96		
Power Cord	Number of core		—		
	Length	m (ft)	—		
Thermostat			Electronic Control		
Protection Device			Electronic Control		

Item		Unit	Indoor Unit		
Performance Test Condition			EN 14511		
Operation Range	Outdoor Ambient	°C	Cooling: 16 ~ 43 Heating: -20 ~ 35		
	Water Outlet	°C	Cooling: 5 ~ 20 Heating: 25 ~ 55		
Internal Pressure Differential		kPa	Cooling: 11.6 Heating: 18.7		
Noise Level		Condition (Ambient/Water)	A35W7	A7W35	A2W35
		dB (A)	Cooling: 33	Cooling: 33	—
		Power Level dB	Cooling: 46	Cooling: 46	—
Dimension	Height	mm (inch)	892 (35-1/8)		
	Width	mm (inch)	502 (19-3/4)		
	Depth	mm (inch)	353 (13-29/32)		
Net Weight		kg (lbs)	45 (99)		
Refrigerant Pipe Diameter	Liquid	mm (inch)	9.52 (3/8)		
	Gas	mm (inch)	15.88 (5/8)		
Water Pipe Diameter	Inlet	mm (inch)	28 (1-3/32)		
	Outlet	mm (inch)	28 (1-3/32)		
Water Drain Hose Inner Diameter		mm (inch)	15 (19/32)		
Pump	Motor Type		DC Motor		
	No. of Speed		7 (Software Selection)		
	Input Power	W	42		
Hot Water Coil	Type		Brazen Plate		
	No. of Plates		36		
	Size (W × H × L)	mm	65 × 120 × 376		
	Water Flow Rate	l/min (m³/h)	Cooling: 20.1 (1.2) Heating: 25.8 (1.5)		
Pressure Relief Valve Water Circuit		kPa	Open: 300, Close: 265 and below		
Flow Switch			Magnetic Lead Switch		
Protection Device		A	Residual Current Circuit Breaker (25)		



Item		Unit	Indoor Unit
Expansion Vessel	Volume	l	10
	MWP	bar	3
Capacity of Integrated Electric Heater		kW	3.00

**Note:**

- Cooling capacities are based on outdoor air temperature of 35°C Dry Bulb with controlled indoor water inlet temperature of 12°C and water outlet temperature of 7°C.
- Heating capacities are based on outdoor air temperature of 7°C Dry Bulb (44.6°F Dry Bulb), 6°C Wet Bulb (42.8°F Wet Bulb) with controlled indoor water inlet temperature of 30°C and water outlet temperature of 35°C.
- Specifications are subjected to change without prior notice for further improvement.

## 2.2 WH-SDC12F9E8 WH-UD12FE8

Item		Unit	Outdoor Unit		
Performance Test Condition			EN 14511		
Cooling Capacity	Condition (Ambient/Water)		A35W7		
	kW		10.00		
	BTU/h		34100		
	kcal/h		8600		
Cooling EER	W/W		2.85		
	kcal/hW		2.45		
Heating Capacity	Condition (Ambient/Water)		A7W35	A2W35	
	kW		12.00	11.40	
	BTU/h		41000	38900	
	kcal/h		10320	9800	
Heating COP	W/W		4.74	3.44	
	kcal/hW		4.08	2.96	
Noise Level	Condition (Ambient/Water)		A35W7	A7W35	A2W35
	dB (A)		Cooling: 50	Heating: 50	—
	Power Level dB		Cooling: 68	Heating: 67	—
Air Flow	m <sup>3</sup> /min (ft <sup>3</sup> /min)		Cooling: 93.3 (3290) Heating: 80.0 (2830)		
Refrigeration Control Device			Expansion Valve		
Refrigeration Oil		cm <sup>3</sup>	FV50S (1200)		
Refrigerant (R410A)		kg (oz)	2.55 (90.0)		
Dimension	Height	mm (inch)	1340 (52-3/4)		
	Width	mm (inch)	900 (35-7/16)		
	Depth	mm (inch)	320 (12-19/32)		
Net Weight		kg (lbs)	108 (238)		
Pipe Diameter	Liquid	mm (inch)	9.52 (3/8)		
	Gas	mm (inch)	15.88 (5/8)		
Standard Length		m (ft)	7 (23.0)		
Pipe Length Range		m (ft)	3 (9.8) ~ 30 (98.4)		
I/D & O/D Height Difference		m (ft)	20 (65.6)		
Additional Gas Amount		g/m (oz/ft)	50 (0.5)		
Refrigeration Charge Less		m (ft)	10 (32.8)		
Compressor	Type		Hermetic Motor / Rotary		
	Motor Type		Brushless (4-poles)		
	Rated Output	kW	4.30		
Fan	Type		Propeller Fan		
	Material		PP		
	Motor Type		DC (8-poles)		
	Input Power	W	—		
	Output Power	W	60		
	Fan Speed	rpm	Cooling: 600 (Top), 640 (Bottom) Heating: 510 (Top), 550 (Bottom)		
Heat Exchanger	Fin material		Aluminium (Pre Coat)		
	Fin Type		Corrugated Fin		
	Row × Stage × FPI		2 × 51 × 18		
	Size (W × H × L)	mm	903.7 × 1295.4 × 38.1		

Item		Unit	Outdoor Unit		
Power Source (Phase, Voltage, Cycle)		ø	Three		
		V	400		
		Hz	50		
Input Power		Condition (Ambient/Water)	A35W7	A7W35	A2W35
		kW	Cooling: 3.51	Heating: 2.53	Heating: 3.31
Maximum Input Power For Heatpump System		kW	5.85		
Power Supply 1 : Phase (Ø) / Max. Current (A) / Max. Input Power (W)		3Ø / 8.8 / 5.85k			
Power Supply 2 : Phase (Ø) / Max. Current (A) / Max. Input Power (W)		3Ø / 13.0 / 9.00k			
Power Supply 3 : Phase (Ø) / Max. Current (A) / Max. Input Power (W)		— / — / —			
Starting Current		A	5.3		
Running Current		Condition (Ambient/Water)	A35W7	A7W35	A2W35
		A	Cooling: 5.3	Heating: 3.8	Heating: 5.0
Maximum Current For Heatpump System		A	8.8		
Power Factor Power factor means total figure of compressor and outdoor fan motor.		%	Cooling: 96	Heating: 96	Heating: 96
Power Cord	Number of core		—		
	Length	m (ft)	—		
Thermostat			Electronic Control		
Protection Device			Electronic Control		

Item		Unit	Indoor Unit		
Performance Test Condition			EN 14511		
Operation Range	Outdoor Ambient	°C	Cooling: 16 ~ 43 Heating: -20 ~ 35		
	Water Outlet	°C	Cooling: 5 ~ 20 Heating: 25 ~ 55		
Internal Pressure Differential		kPa	Cooling: 23.1 Heating: 33.0		
Noise Level		Condition (Ambient/Water)	A35W7	A7W35	A2W35
		dB (A)	Cooling: 33	Cooling: 33	—
		Power Level dB	Cooling: 46	Cooling: 46	—
Dimension	Height	mm (inch)	892 (35-1/8)		
	Width	mm (inch)	502 (19-3/4)		
	Depth	mm (inch)	353 (13-29/32)		
Net Weight		kg (lbs)	46 (101)		
Refrigerant Pipe Diameter	Liquid	mm (inch)	9.52 (3/8)		
	Gas	mm (inch)	15.88 (5/8)		
Water Pipe Diameter	Inlet	mm (inch)	28 (1-3/32)		
	Outlet	mm (inch)	28 (1-3/32)		
Water Drain Hose Inner Diameter		mm (inch)	15 (19/32)		
Pump	Motor Type		DC Motor		
	No. of Speed		7 (Software Selection)		
	Input Power	W	60		
Hot Water Coil	Type		Brazen Plate		
	No. of Plates		36		
	Size (W × H × L)	mm	65 × 120 × 376		
	Water Flow Rate	l/min (m³/h)	Cooling: 28.7 (1.7) Heating: 34.4 (2.1)		
Pressure Relief Valve Water Circuit		kPa	Open: 300, Close: 265 and below		
Flow Switch			Magnetic Lead Switch		
Protection Device		A	Residual Current Circuit Breaker (25)		

Item		Unit	Indoor Unit
Expansion Vessel	Volume	l	10
	MWP	bar	3
Capacity of Integrated Electric Heater		kW	9.00

**Note:**

- Cooling capacities are based on outdoor air temperature of 35°C Dry Bulb with controlled indoor water inlet temperature of 12°C and water outlet temperature of 7°C.
- Heating capacities are based on outdoor air temperature of 7°C Dry Bulb (44.6°F Dry Bulb), 6°C Wet Bulb (42.8°F Wet Bulb) with controlled indoor water inlet temperature of 30°C and water outlet temperature of 35°C.
- Specifications are subjected to change without prior notice for further improvement.

## 2.3 WH-SDC14F9E8 WH-UD14FE8

Item		Unit	Outdoor Unit		
Performance Test Condition			EN 14511		
Cooling Capacity	Condition (Ambient/Water)		A35W7		
	kW		11.50		
	BTU/h		39200		
	kcal/h		9890		
Cooling EER	W/W		2.64		
	kcal/hW		2.27		
Heating Capacity	Condition (Ambient/Water)		A7W35	A2W35	
	kW		14.00	12.40	
	BTU/h		47800	42300	
	kcal/h		12040	10660	
Heating COP	W/W		4.56	3.36	
	kcal/hW		3.92	2.89	
Noise Level	Condition (Ambient/Water)		A35W7	A7W35	A2W35
	dB (A)		Cooling: 52	Heating: 51	—
	Power Level dB		Cooling: 70	Heating: 68	—
Air Flow	m <sup>3</sup> /min (ft <sup>3</sup> /min)		Cooling: 97.8 (3450) Heating: 84.0 (2970)		
Refrigeration Control Device			Expansion Valve		
Refrigeration Oil		cm <sup>3</sup>	FV50S (1200)		
Refrigerant (R410A)		kg (oz)	2.55 (90.0)		
Dimension	Height	mm (inch)	1340 (52-3/4)		
	Width	mm (inch)	900 (35-7/16)		
	Depth	mm (inch)	320 (12-19/32)		
Net Weight		kg (lbs)	108 (238)		
Pipe Diameter	Liquid	mm (inch)	9.52 (3/8)		
	Gas	mm (inch)	15.88 (5/8)		
Standard Length		m (ft)	7 (23.0)		
Pipe Length Range		m (ft)	3 (9.8) ~ 30 (98.4)		
I/D & O/D Height Difference		m (ft)	20 (65.6)		
Additional Gas Amount		g/m (oz/ft)	50 (0.5)		
Refrigeration Charge Less		m (ft)	10 (32.8)		
Compressor	Type		Hermetic Motor / Rotary		
	Motor Type		Brushless (4-poles)		
	Rated Output	kW	4.30		
Fan	Type		Propeller Fan		
	Material		PP		
	Motor Type		DC (8-poles)		
	Input Power	W	—		
	Output Power	W	60		
	Fan Speed	rpm	Cooling: 630 (Top), 670 (Bottom) Heating: 540 (Top), 580 (Bottom)		
Heat Exchanger	Fin material		Aluminium (Pre Coat)		
	Fin Type		Corrugated Fin		
	Row × Stage × FPI		2 × 51 × 18		
	Size (W × H × L)	mm	903.7 × 1295.4 × 38.1		

Item		Unit	Outdoor Unit		
Power Source (Phase, Voltage, Cycle)		∅	Three		
		V	400		
		Hz	50		
Input Power		Condition (Ambient/Water)	A35W7	A7W35	A2W35
		kW	Cooling: 4.36	Heating: 3.07	Heating: 3.69
Maximum Input Power For Heatpump System		kW	6.25		
Power Supply 1 : Phase (∅) / Max. Current (A) / Max. Input Power (W)		3∅ / 9.4 / 6.25k			
Power Supply 2 : Phase (∅) / Max. Current (A) / Max. Input Power (W)		3∅ / 13.0 / 9.00k			
Power Supply 3 : Phase (∅) / Max. Current (A) / Max. Input Power (W)		— / — / —			
Starting Current		A	6.5		
Running Current		Condition (Ambient/Water)	A35W7	A7W35	A2W35
		A	Cooling: 6.5	Heating: 4.7	Heating: 5.6
Maximum Current For Heatpump System		A	9.4		
Power Factor Power factor means total figure of compressor and outdoor fan motor.		%	Cooling: 97	Heating: 95	Heating: 95
Power Cord	Number of core		—		
	Length	m (ft)	—		
Thermostat			Electronic Control		
Protection Device			Electronic Control		

Item		Unit	Indoor Unit		
Performance Test Condition			EN 14511		
Operation Range	Outdoor Ambient	°C	Cooling: 16 ~ 43 Heating: -20 ~ 35		
	Water Outlet	°C	Cooling: 5 ~ 20 Heating: 25 ~ 55		
Internal Pressure Differential		kPa	Cooling: 31.5 Heating: 45.0		
Noise Level		Condition (Ambient/Water)	A35W7	A7W35	A2W35
		dB (A)	Cooling: 33	Cooling: 33	—
		Power Level dB	Cooling: 46	Cooling: 46	—
Dimension	Height	mm (inch)	892 (35-1/8)		
	Width	mm (inch)	502 (19-3/4)		
	Depth	mm (inch)	353 (13-29/32)		
Net Weight		kg (lbs)	47 (104)		
Refrigerant Pipe Diameter	Liquid	mm (inch)	9.52 (3/8)		
	Gas	mm (inch)	15.88 (5/8)		
Water Pipe Diameter	Inlet	mm (inch)	28 (1-3/32)		
	Outlet	mm (inch)	28 (1-3/32)		
Water Drain Hose Inner Diameter		mm (inch)	15 (19/32)		
Pump	Motor Type		DC Motor		
	No. of Speed		7 (Software Selection)		
	Input Power	W	76		
Hot Water Coil	Type		Brazen Plate		
	No. of Plates		44		
	Size (W × H × L)	mm	80 × 120 × 376		
	Water Flow Rate	l/min (m³/h)	Cooling: 33.0 (2.0) Heating: 40.1 (2.4)		
Pressure Relief Valve Water Circuit		kPa	Open: 300, Close: 265 and below		
Flow Switch			Magnetic Lead Switch		
Protection Device		A	Residual Current Circuit Breaker (25)		

Item		Unit	Indoor Unit
Expansion Vessel	Volume	l	10
	MWP	bar	3
Capacity of Integrated Electric Heater		kW	9.00

**Note:**

- Cooling capacities are based on outdoor air temperature of 35°C Dry Bulb with controlled indoor water inlet temperature of 12°C and water outlet temperature of 7°C.
- Heating capacities are based on outdoor air temperature of 7°C Dry Bulb (44.6°F Dry Bulb), 6°C Wet Bulb (42.8°F Wet Bulb) with controlled indoor water inlet temperature of 30°C and water outlet temperature of 35°C.
- Specifications are subjected to change without prior notice for further improvement.

## 2.4 WH-SDC16F9E8 WH-UD16FE8

Item		Unit	Outdoor Unit		
Performance Test Condition			EN 14511		
Cooling Capacity	Condition (Ambient/Water)		A35W7		
	kW		12.20		
	BTU/h		41600		
	kcal/h		10490		
Cooling EER	W/W		2.56		
	kcal/hW		2.20		
Heating Capacity	Condition (Ambient/Water)		A7W35	A2W35	
	kW		16.00	13.00	
	BTU/h		54600	44300	
	kcal/h		13760	11180	
Heating COP	W/W		4.28	3.28	
	kcal/hW		3.68	2.82	
Noise Level	Condition (Ambient/Water)		A35W7	A7W35	A2W35
	dB (A)		Cooling: 54	Heating: 53	—
	Power Level dB		Cooling: 72	Heating: 70	—
Air Flow	m <sup>3</sup> /min (ft <sup>3</sup> /min)		Cooling: 97.8 (3450) Heating: 90.0 (3180)		
Refrigeration Control Device			Expansion Valve		
Refrigeration Oil		cm <sup>3</sup>	FV50S (1200)		
Refrigerant (R410A)		kg (oz)	2.55 (90.0)		
Dimension	Height	mm (inch)	1340 (52-3/4)		
	Width	mm (inch)	900 (35-7/16)		
	Depth	mm (inch)	320 (12-19/32)		
Net Weight		kg (lbs)	108 (238)		
Pipe Diameter	Liquid	mm (inch)	9.52 (3/8)		
	Gas	mm (inch)	15.88 (5/8)		
Standard Length		m (ft)	7 (23.0)		
Pipe Length Range		m (ft)	3 (9.8) ~ 30 (98.4)		
I/D & O/D Height Difference		m (ft)	20 (65.6)		
Additional Gas Amount		g/m (oz/ft)	50 (0.5)		
Refrigeration Charge Less		m (ft)	10 (32.8)		
Compressor	Type		Hermetic Motor / Rotary		
	Motor Type		Brushless (4-poles)		
	Rated Output	kW	4.30		
Fan	Type		Propeller Fan		
	Material		PP		
	Motor Type		DC / Transistor (8-poles)		
	Input Power	W	—		
	Output Power	W	60		
	Fan Speed	rpm	Cooling: 630 (Top), 670 (Bottom) Heating: 580 (Top), 620 (Bottom)		
Heat Exchanger	Fin material		Aluminium (Pre Coat)		
	Fin Type		Corrugated Fin		
	Row × Stage × FPI		2 × 51 × 18		
	Size (W × H × L)	mm	903.7 × 1295.4 × 38.1		



Item		Unit	Outdoor Unit		
Power Source (Phase, Voltage, Cycle)		ø	Three		
		V	400		
		Hz	50		
Input Power		Condition (Ambient/Water)	A35W7	A7W35	A2W35
		kW	Cooling: 4.76	Heating: 3.74	Heating: 3.96
Maximum Input Power For Heatpump System		kW	6.59		
Power Supply 1 : Phase (Ø) / Max. Current (A) / Max. Input Power (W)		3Ø / 9.9 / 6.59k			
Power Supply 2 : Phase (Ø) / Max. Current (A) / Max. Input Power (W)		3Ø / 13.0 / 9.00k			
Power Supply 3 : Phase (Ø) / Max. Current (A) / Max. Input Power (W)		— / — / —			
Starting Current		A	7.1		
Running Current		Condition (Ambient/Water)	A35W7	A7W35	A2W35
		A	Cooling: 7.1	Heating: 5.7	Heating: 6.0
Maximum Current For Heatpump System		A	9.9		
Power Factor Power factor means total figure of compressor and outdoor fan motor.		Condition (Ambient/Water)	A35W7	A7W35	A2W35
		%	Cooling: 97	Heating: 95	Heating: 96
Power Cord	Number of core	—			
	Length	m (ft)	—		
Thermostat		Electronic Control			
Protection Device		Electronic Control			

Item		Unit	Indoor Unit		
Performance Test Condition		EN 14511			
Operation Range	Outdoor Ambient	°C	Cooling: 16 ~ 43 Heating: -20 ~ 35		
	Water Outlet	°C	Cooling: 5 ~ 20 Heating: 25 ~ 55		
Internal Pressure Differential		kPa	Cooling: 35.2 Heating: 58.0		
Noise Level		Condition (Ambient/Water)	A35W7	A7W35	A2W35
		dB (A)	Cooling: 33	Cooling: 33	—
		Power Level dB	Cooling: 46	Cooling: 46	—
Dimension	Height	mm (inch)	892 (35-1/8)		
	Width	mm (inch)	502 (19-3/4)		
	Depth	mm (inch)	353 (13-29/32)		
Net Weight		kg (lbs)	47 (104)		
Refrigerant Pipe Diameter	Liquid	mm (inch)	9.52 (3/8)		
	Gas	mm (inch)	15.88 (5/8)		
Water Pipe Diameter	Inlet	mm (inch)	28 (1-3/32)		
	Outlet	mm (inch)	28 (1-3/32)		
Water Drain Hose Inner Diameter		mm (inch)	15 (19/32)		
Pump	Motor Type	DC Motor			
	No. of Speed	7 (Software Selection)			
	Input Power	W	105		
Hot Water Coil	Type	Brazed Plate			
	No. of Plates	44			
	Size (W × H × L)	mm	80 × 120 × 376		
	Water Flow Rate	l/min (m³/h)	Cooling: 35.0 (2.1) Heating: 45.9 (2.8)		
Pressure Relief Valve Water Circuit		kPa	Open: 300, Close: 265 and below		
Flow Switch		Magnetic Lead Switch			
Protection Device		A	Residual Current Circuit Breaker (25)		

Item		Unit	Indoor Unit
Expansion Vessel	Volume	l	10
	MWP	bar	3
Capacity of Integrated Electric Heater		kW	9.00

**Note:**

- Cooling capacities are based on outdoor air temperature of 35°C Dry Bulb with controlled indoor water inlet temperature of 12°C and water outlet temperature of 7°C.
- Heating capacities are based on outdoor air temperature of 7°C Dry Bulb (44.6°F Dry Bulb), 6°C Wet Bulb (42.8°F Wet Bulb) with controlled indoor water inlet temperature of 30°C and water outlet temperature of 35°C.
- Specifications are subjected to change without prior notice for further improvement.

### 3. Features

- **Inverter Technology**
  - Energy saving
- **High Efficiency**
- **Environment Protection**
  - Non-ozone depletion substances refrigerant (R410A)
- **Long Installation Piping**
  - Long piping up to 30 meter with height difference 20 meter
  - Flexible 4-way piping for outdoor unit
- **Easy to use control panel**
  - Auto mode
  - Holiday mode
  - Dry concrete function
  - Weekly timer setting
- **A-class energy efficiency pump**
  - Water pump speed can be set by selection at control panel
- **Improved deice cycle**
- **Protection Feature**
  - Random auto restart after power failure for safety restart operation
  - Gas leakage protection
  - Prevent compressor reverse cycle
  - Inner protector to protect compressor
- **Serviceability Feature**
  - Breakdown Self Diagnosis function
  - System Status Check Buttons for servicing purpose
  - System Pumpdown Button for servicing purpose
  - Front maintenance design for outdoor unit

## 4. Location of Controls and Components

### 4.1 Indoor Unit

#### 4.1.1 Location of Control

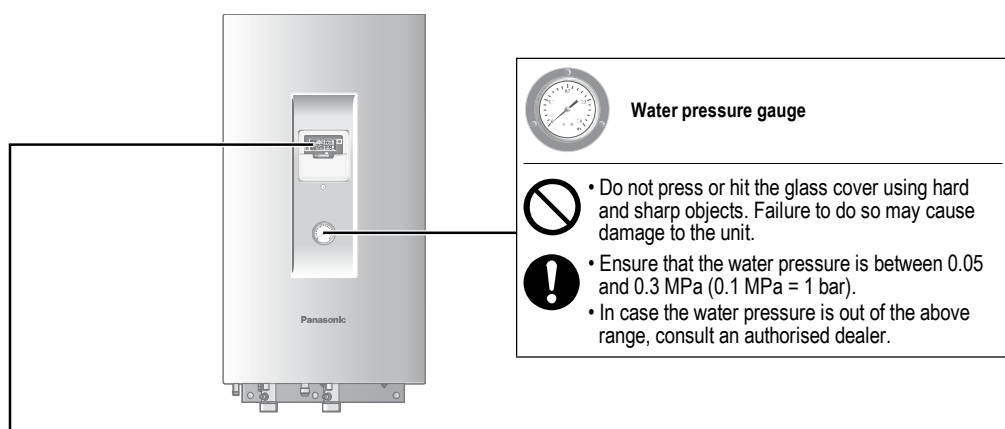

**Control Panel**

- ① **OFF/ON Button**  
This button starts or stops the mode operation function of the unit.
- ② **Operation LED**  
This LED indicates the unit is in operation.
- ③ **External Thermo Controller Connected Display**  
This LCD show the external thermo controller connected display.
- ④ **Force Heater Request OFF/ON Indicator**  
This icon indicates force heater request OFF/ON mode operation.
- ⑤ **Backup Heater Enabled/Disabled Indicator**  
This icon indicates backup heater enabled/disabled mode operation.
- ⑥ **Quiet Mode Indicator**  
This icon indicates quiet mode operation.
- ⑦ **Tank Mode Indicator**  
This icon indicates tank mode operation.
- ⑧ **Cool Mode OFF/ON Indicator**  
This icon indicates cooling mode OFF/ON operation.
- ⑨ **Heat Mode OFF/ON Indicator**  
This icon indicates heating mode OFF/ON operation.
- ⑩ **Auto Mode OFF/ON Indicator**  
This icon indicates auto mode OFF/ON operation.
- ⑪ **Solar Display**  
This LCD show the solar display.
- ⑫ **Caution (Tank Temperature above 60°C) Indicator**  
This LCD show the Caution display.
- ⑬ **Timer/Clock Setting Display**  
This LCD show the weekly schedule timer setting and clock display.
- ⑭ **Outdoor Ambient Temperature Display**  
This LCD show the outdoor ambient temperature.
- ⑮ **Water Outlet Temperature Display**  
This LCD show the water outlet temperature.
- ⑯ **Backup Heater Actual (OFF/ON) Indicator**  
This icon indicates backup heater actual (OFF/ON) operation.
- ⑰ **Booster Heater Actual (OFF/ON) Indicator**  
This icon indicates booster heater actual (OFF/ON) operation.
- ⑱ **System Setting Mode OFF/ON Indicator**  
This icon indicates the system setting mode request OFF/ON display.
- ⑲ **System Status Check Mode OFF/ON Indicator**  
This icon indicates the status check mode request OFF/ON display.
- ⑳ **System Service Mode OFF/ON Indicator**  
This icon indicates the system service mode request OFF/ON display.

## 4.1.2 To adjust initial settings

Dealer

**Select menus and determine settings according to the system available in the household. It is recommended that all alterations of settings are done by an authorised dealer or specialist.**

- After initial installation, you may manually adjust the settings. The initial setting remains active until the user changes it.
- The control panel can be used for multiple installations.
- Ensure the operation LED is OFF before setting.
- The system may not work properly if set wrongly. Please consult an authorised dealer.

- 1 Press **SET** and **CHECK** simultaneously and hold for 5 seconds until the display shows **SETTING STATUS**.
- 2 Press **▲** or **▼** to select the menu.
- 3 Press **SELECT** to enter the menu.
- 4 Press **▲** or **▼** to select Yes/No, or other options.  
**YES:** to enable the menu  
**No:** to disable the menu
- 5 Press **SET** to confirm.

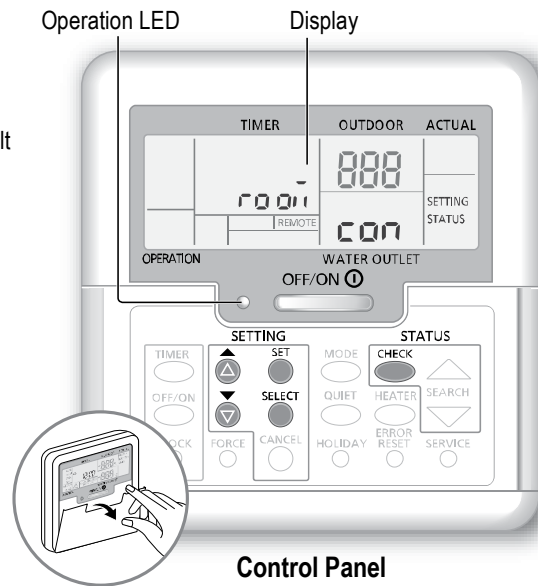

Control Panel

Menu (1 ~ 20)	Setting		Display
<b>1 Room Thermostat Connection</b> To select whether or not to connect to the optional room thermostat.	YES	NO	room con
<b>2 Indoor Backup Heater Selection</b> To reduce the heater power if unnecessary. *Options of kW vary depending on the model.	*3 kW / 6 kW / 9 kW		HEATER CAP
<b>3 Water System Freeze Prevention</b> To activate or deactivate the water freeze prevention when the system is OFF.	YES	NO	Ant. FrE
<b>4 Tank Connection</b> To select whether or not to connect to the optional water tank unit. Note: If NO is selected, menus 5 to 15 are skipped.	YES	NO	TANK con
<b>5 Solar Priority</b> To select the use of solar panel for heating up the water tank.	YES	NO	SOLAR PrY
<b>6 *1, *2 Cooling Priority</b> To choose the room cooling as priority during COOL + TANK mode. Note: If YES is selected, menus 8 and 9 are skipped for COOL + TANK mode.	YES	NO	COOL PrY
<b>7 Heating Priority</b> To select the room heating as priority during HEAT + TANK mode. Note: If YES is selected, menus 8 and 9 are skipped for HEAT + TANK mode.	YES	NO	HEAT PrY
<b>8 *1, *2 Cooling/Heating Operation Interval</b> To set the interval for COOL or HEAT mode during COOL + TANK or HEAT + TANK mode. Note: If YES is selected in menus 6 and 7, this menu is skipped.	0.5 hours ~ 10 hours		COOL/HEAT int
<b>9 *1 Tank Heat-up Interval</b> To set the interval for the water tank during COOL + TANK or HEAT + TANK mode. Note: If YES is selected in menus 6 and 7, this menu is skipped.	5 minutes ~ 1 hour 35 minutes		TANK int





**Dealer** Operation/settings to be done only by the authorised dealer/specialist.

**User** Operation/settings to be done by the authorised dealer/specialist or user.

<b>10 Booster Heater</b> To activate or deactivate the water tank's booster heater. Note: If NO is selected, menu 11 is skipped.	YES	NO	BOOSTER	Fun
<b>11 Booster Heater Delay Timer</b> To delay time for the booster heater to activate while the system is heating up the water tank.	20 minutes ~ 1 hour 35 minutes		BOOSTER	dly
<ul style="list-style-type: none"> <li>Do not use the system during sterilisation in order to prevent scalding with hot water, or overheating of shower.</li> <li>Ask an authorised dealer to determine the level of sterilisation function field settings according to the local laws and regulations.</li> </ul>				
<b>12 Sterilisation</b> To sterilise the water tank, if required. Note: If NO is selected, menus 13 to 15 are skipped.	YES	NO	St rL	Fun
<b>13 Sterilisation Day &amp; Time</b> To set timer for sterilisation. (Only once a week. Operates even under a standby condition)	Monday ~ Sunday 0:00 ~ 23:50		St r	
<b>14 Sterilisation Temperature</b> To set the temperature of sterilisation.	40 °C ~ 75 °C		St rL	bo i
<b>15 Continuation of Sterilisation</b> To maintain heating temperature in order to complete the sterilisation.	5 minutes ~ 1 hour		St r	opr
<b>16 Base Pan Heater</b> To select whether or not to connect to the optional base pan heater. Note: If NO is selected, menu 17 is skipped.	YES	NO	bP An	ht r
<b>17 Base Pan Heater type</b> Type A - The base pan heater activates only during deice operation. Type B - The base pan heater activates when outdoor ambient temperature is 5 °C or lower.	A	B	bP An	ht r
<b>18 *1,*2 Cool Outdoor Temperature setting</b> To set the outdoor ambient temperature for the AUTO mode to change from HEAT to COOL.	5 °C ~ 25 °C		H -C	SEt
<b>19 *1,*2 Heat Outdoor Temperature setting</b> To set the outdoor ambient temperature for the AUTO mode to change from COOL to HEAT.	5 °C ~ 25 °C		C -H	SEt
<b>20 Dry Concrete</b> During construction to dry the concrete under a preset temperature. Do not use this menu for any other purposes and in period other than during construction.	1 day ~ 99 days		dr y	Con

**User**

### Control panel preparation

- Press  .
- Press  or  to set the current day.
- Press  to confirm.
- Repeat steps ② and ③ to set the current time.

#### ■ Note:

- The current day and time need to be set in cases below:
  - When the power is turned on for the first time.
  - A long time has elapsed since the power was turned on the last time.
- The current time that has been set will be the standard time for all the timer operations.

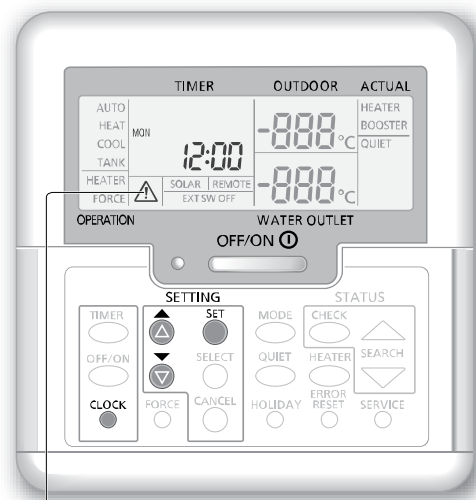

Caution Indicator (Tank Temperature above 60 °C)

\*1 The system is locked to operate without COOL mode. It can be unlocked only by authorized installers or our authorized service partners.

\*2 Only displayed when COOL mode is unlocked (Means when COOL mode is available).

### 4.1.3 How to use

User

#### Turn on or off the system

Press .

When the system is ON, the operation LED is lit and the actual water outlet temperature and outdoor ambient temperature are shown on the display.

User

#### Select operation mode

Press  to select operation mode.

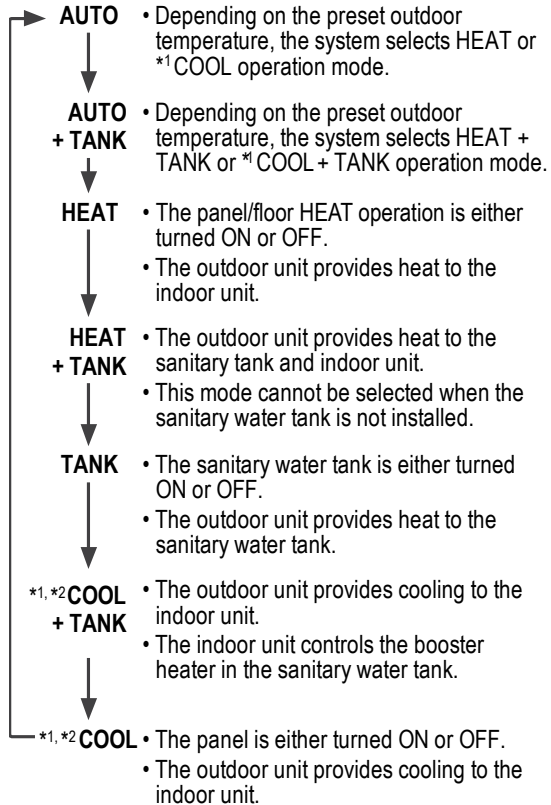

User

#### Initiate the backup heater

Press .

- The backup heater provides extra heat at low outdoor temperature. The backup heater is possible only in the heat mode.
- Once the backup heater is set, it is automatically operated when conditions are fulfilled.
- To disable the backup heater, press  again.

The system is turned off by an external switch.

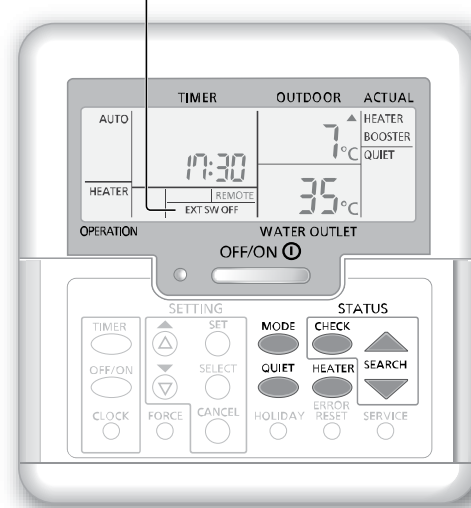

User





#### Enjoy quiet operation

Press .

- This operation reduces the noise of outdoor unit. The operation may cause heating/\*1 cooling ability to decrease.

User

#### System status check mode

- Press . (The display shows STATUS.)
- Press  or  to check the selected mode.
  - Dry concrete (does not show during normal operation)
  - The Water Inlet Temperature
  - Tank Temperature
  - Compressor Running Frequency
  - Error History
  - Heat mode total power consumption (Up to 999 days)
  - \*1 Cool mode total power consumption (Up to 999 days)
  - Tank mode total power consumption (Up to 999 days)
  - Press  to exit the STATUS mode.

#### Note:

- Once the STATUS mode is entered, the display shows STATUS.
- The STATUS mode cannot be activated when the display shows SETTING.
- The total power consumption is an estimated value based on AC 230 V and may differ from value measured by precise equipment.

**Note:** In normal operation, the , , and  buttons are not in use.

**Dealer** Operation/settings to be done only by the authorised dealer/specialist.







**User** Operation/settings to be done by the authorised dealer/specialist or user.

**Dealer**

## System temperature setting

The system controls the temperature for each menu based on the outdoor ambient temperature.

• To set or change the temperatures, make sure to contact your nearest authorised dealer.



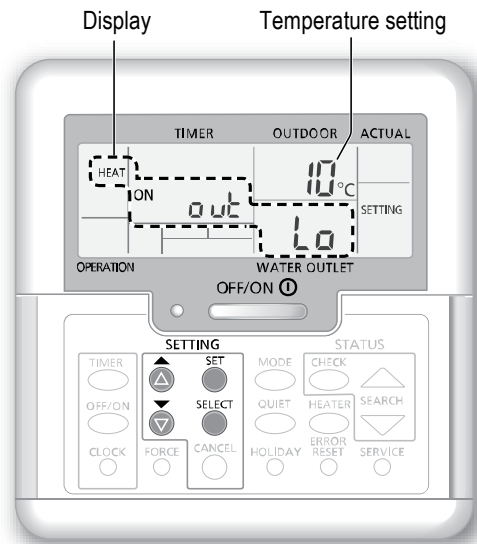

- ① Press and hold  for 5 seconds to enter the temperature range setting mode.  
(The display shows SETTING.)
- ② Press  or  to select a menu.
- ③ Press  to enter the menu.
- ④ Press  or  to set the desired temperature.
- ⑤ Press  to confirm the setting.

• Repeat steps ② to ⑤ to set other menus.



**User**

## Checking the temperature range

- ① Press and hold  for 5 seconds to enter the temperature range setting mode.
  - ② Press  or  to select a menu.
- Press  to exit.

Menu	Temperature setting	Display	
Setting of low outdoor ambient temperature.	-15 °C ~ 15 °C	HEAT	ON out Lo
Setting of high outdoor ambient temperature.	-15 °C ~ 15 °C		ON out Hi
Setting of water outlet temperature at low outdoor ambient temperature.	25 °C ~ 55 °C		ON H2O Lo
Setting of water outlet temperature at high outdoor ambient temperature.	25 °C ~ 55 °C		ON H2O Hi
During HEAT mode, the water outlet temperature is adjusted as is shown the diagram on the right. It is performed within the preset temperature range.			
Setting of outdoor ambient temperature to turn OFF heating operation during HEAT mode.	5 °C ~ 35 °C	HEAT	OFF SET
Setting of outdoor ambient temperature to turn ON the backup heater.	-15 °C ~ 20 °C	HEATER	ON out SET
Setting of water outlet temperature during*1 COOL mode.	5 °C ~ 20 °C	*1 *2 COOL	SET
Setting of sanitary water tank temperature.	40 °C ~ 75 °C	TANK	SET





\*1 The system is locked to operate without COOL mode. It can be unlocked only by authorized installers or our authorized service partners.

\*2 Only displayed when COOL mode is unlocked (Means when COOL mode is available).



## Shifting the water temperature

This easily shifts the water outlet temperature if the setting is undesirable.

- ① Press  to enter the water temperature shifting mode.
- ② Press  to change setting.
- ③ Press  or  to set the desired temperature.  
(temperature range: -5 °C ~ 5 °C)

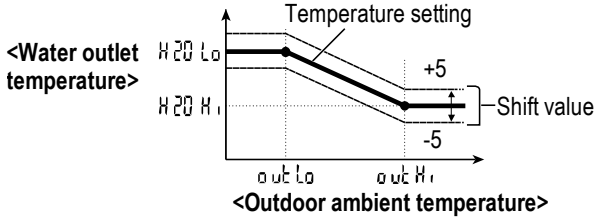

- ④ Press  to confirm the setting.

### Note:

- Press  or wait for 30 seconds to exit the SETTING mode.
- The set temperature will be saved in the system once confirmed.
- The SETTING mode cannot be activated when the SERVICE and STATUS indicators are ON.
- The system will shift the temperature within water outlet temperature range.

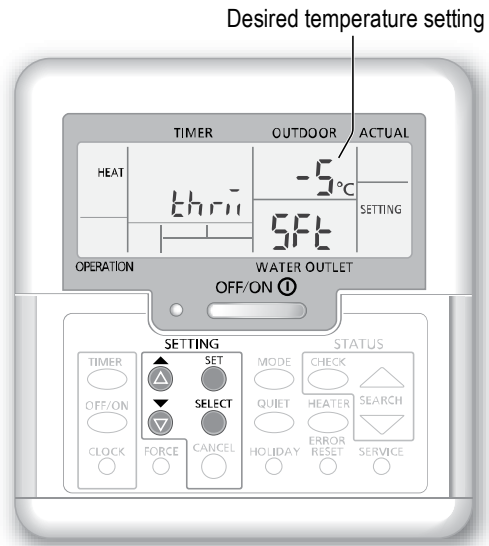





## Holiday mode

- By setting the day (s) in holiday mode, it promotes energy saving while you are on holiday, and enables the system to resume at the preset temperature after your holiday.
- Ensure that the system is OFF before setting.
- The system will resume operation automatically at 00:00 am after the holiday.
- The day the HOLIDAY mode was set is counted as day 1.

Example:

Setting the holiday mode on June 21, 08:00 am. By setting 3 days, the system resumes operation on June 24, 00:00 am.

- ① Press  to enter the HOLIDAY mode.
- ② Press  or  to set the desired days.  
(Setting range: 1 day ~ 999 days)
- ③ Press  to confirm the setting.

### Note:

- Press  or wait 30 seconds to exit the HOLIDAY mode.

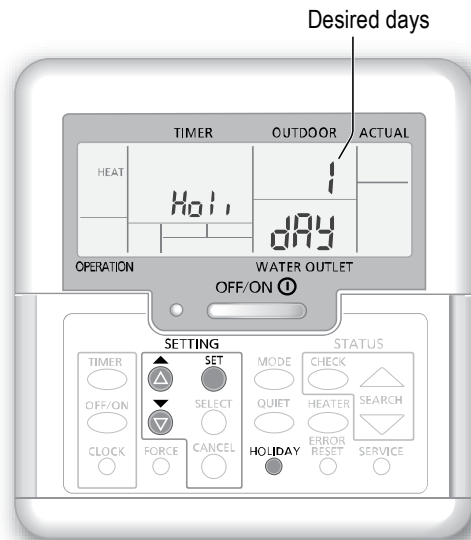

**Dealer** Operation/settings to be done only by the authorised dealer/specialist.

**User** Operation/settings to be done by the authorised dealer/specialist or user.

**User**

## Weekly timer setting

Promotes energy saving by allowing you to set up to 6 programmes in any given day.

Lights up if Timer operation is selected

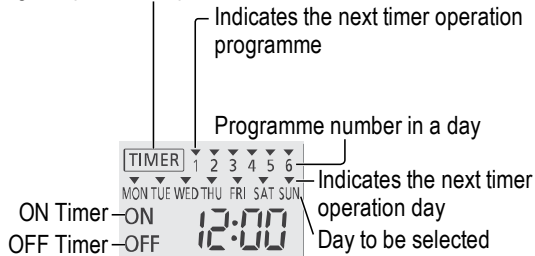

- 1 Press **TIMER** to enter the timer setting mode.
- 2 Press **▲** or **▼** to select your desired day.
- 3 Press **SELECT** to confirm your selection.
- 4 "1" will be blinking, press **SELECT** to set programme 1.
- 5 Press **OFF/ON** to select ON or OFF timer.
- 6 Press **▲** or **▼** to select your desired time. You can set **MODE**, **QUIET**, **HEATER** and the Water Temperature Thermo Shift setting.
- 7 Press **SET** to confirm programme 1. The selected day will be highlighted with **▼**.
  - After 2 seconds, the display will move to the next programme. Repeat steps 4 to 7 to set programmes 2 to 6.
  - During timer setup, if no button is pressed within 30 seconds, or if the **SET** is pressed, the setting at that moment is confirmed and timer setup is ended.

## To check current timer programme

- 1 Press **TIMER** to enter timer mode and press **SELECT** to enter day setting.
- 2 Press **▲** or **▼** until your desired day is shown, press **SELECT** to confirm your selection.
- 3 Press **▲** or **▼** to check the set programmes.

### Note:

- You may set the timer for each day of the week (Monday to Sunday) with 6 programmes per day.
- When the system is switched on by the timer, it will use the previously set temperature to control the water outlet temperature.
- The same timer programme cannot be set on the same day.
- You may also select 2 or more days with the same timer setting.

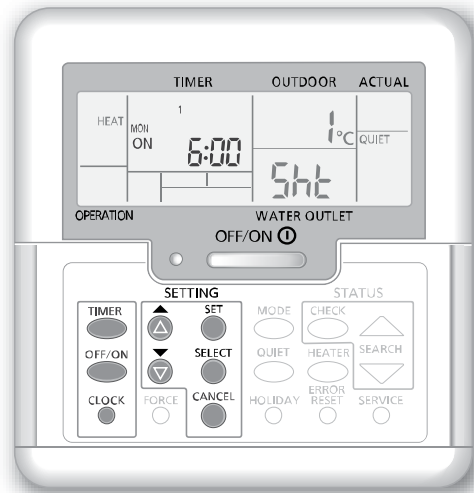

## To modify current timer programme or add new timer programme

- 1 Perform steps 1 to 7 of "Weekly timer setting" to modify existing timer programme, or add any timer programme.

## To cancel current timer programme

- 1 Press **SELECT** to enter day.
- 2 Press **▲** or **▼** until your desired day is shown, press **SELECT** to enter programme setting.
- 3 Press **▲** or **▼** until your desired day is shown. Press **CANCEL** to cancel the programme and **▼** will disappear.

## To disable/enable Weekly Timer

- To disable weekly timer setting, press **TIMER**, then press **CANCEL**.
- To enable previous weekly timer setting, press **TIMER**, then press **SET**.

## Dry Concrete Function



• During construction to dry the concrete under a preset temperature.

① Press  and  simultaneously and hold for 5 seconds until the display shows "r0 01 con".

② Press .

(The display shows "dr 4 [0n]").

③ Press  to select day.

Press  or  to set the desired temperature.

④ Press  to confirm the selection.

⑤ Repeat step ③ and ④ to set other days and temperature.

• Press  to exit.

#### 4.1.4 Main Components

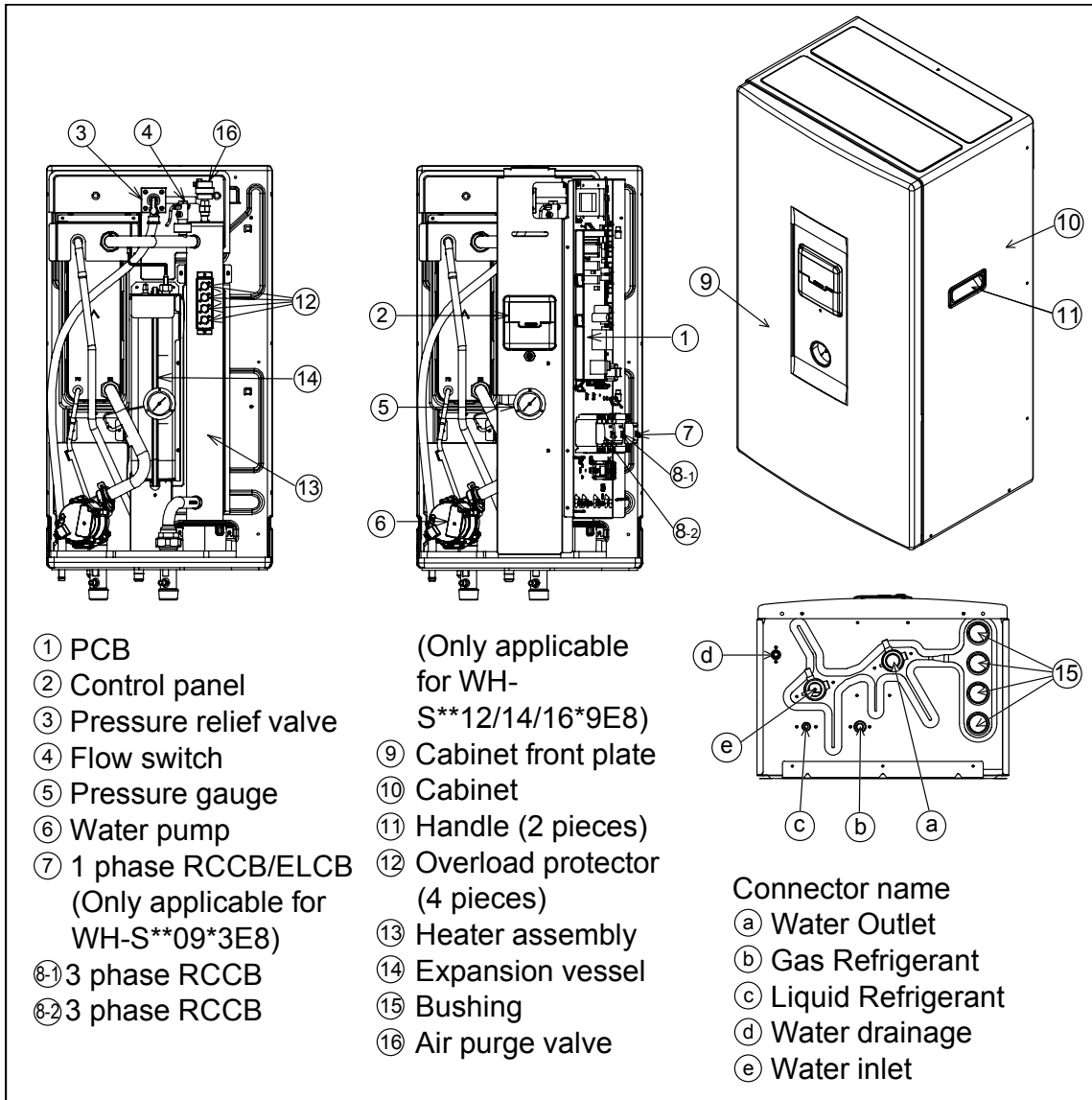

#### 4.2 Outdoor Unit

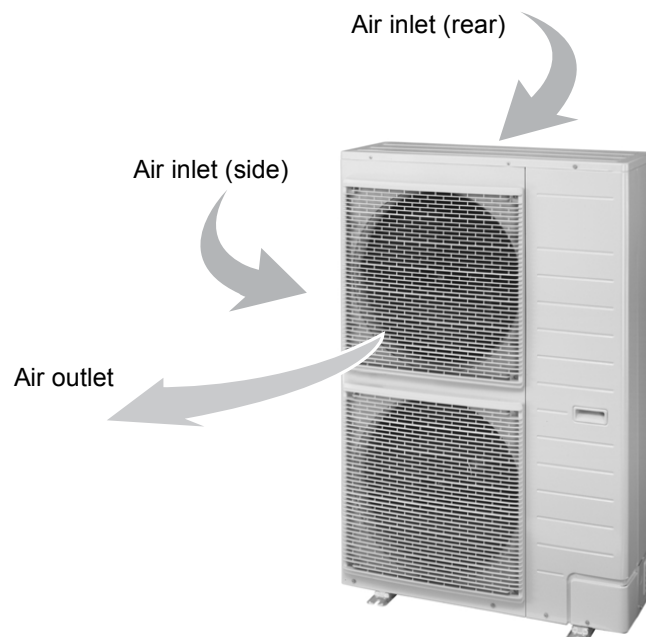

# 5. Dimensions

## 5.1 Indoor Unit

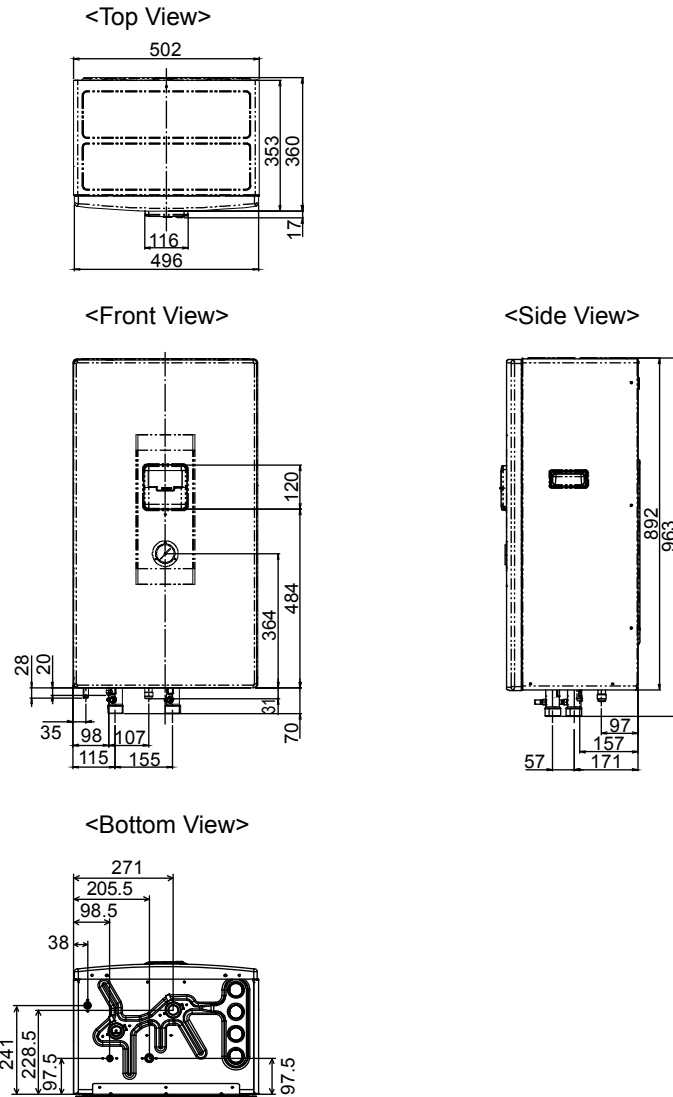

Relative position between the indoor unit and the installation plate <Front View>

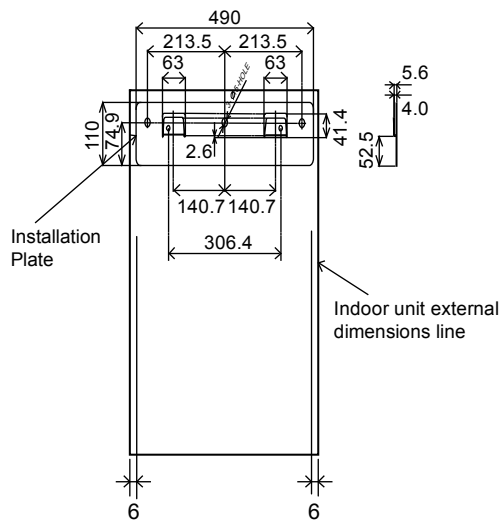

Unit: mm

## 5.2 Outdoor Unit

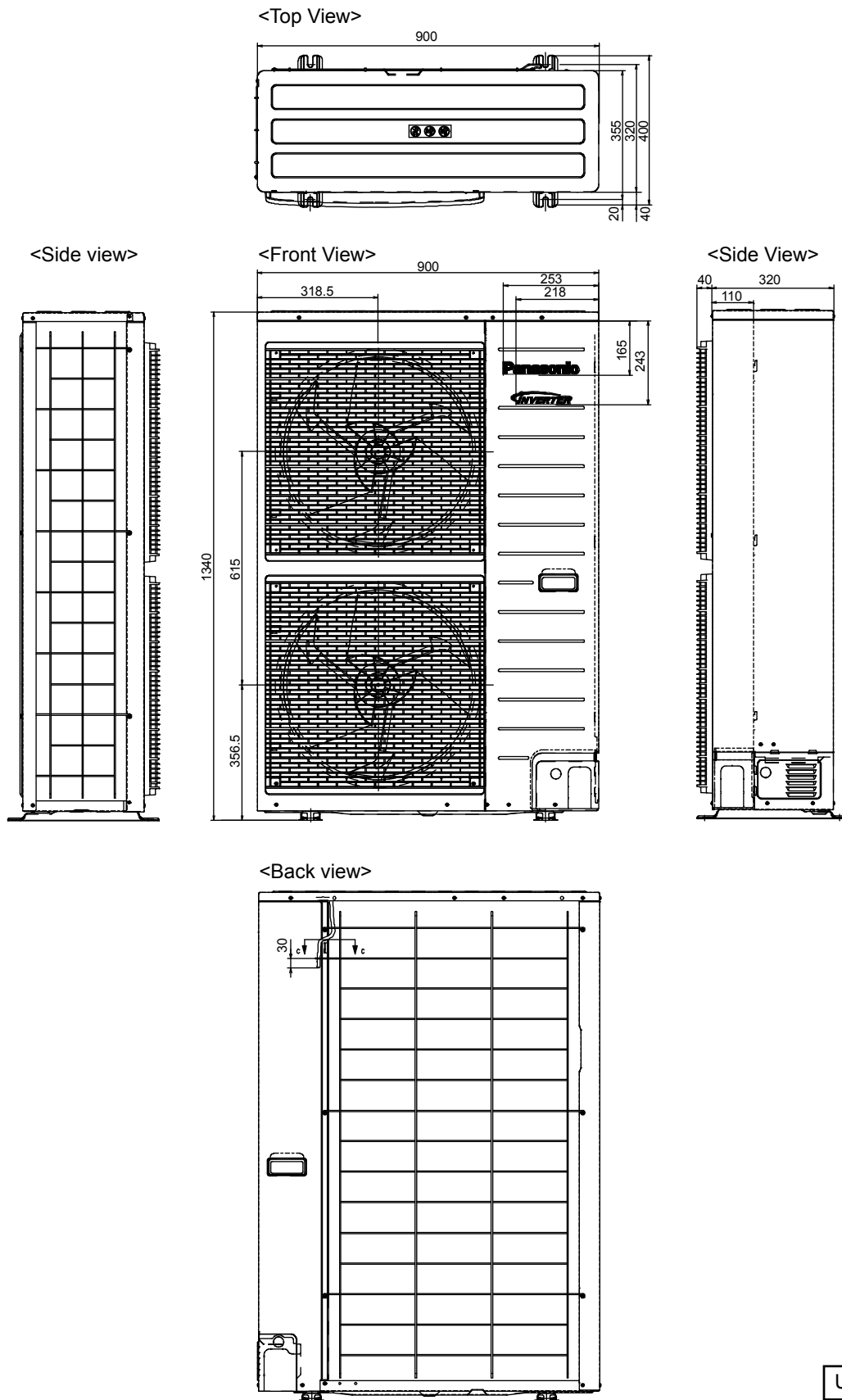

# 6. Refrigeration and Water Cycle Diagram

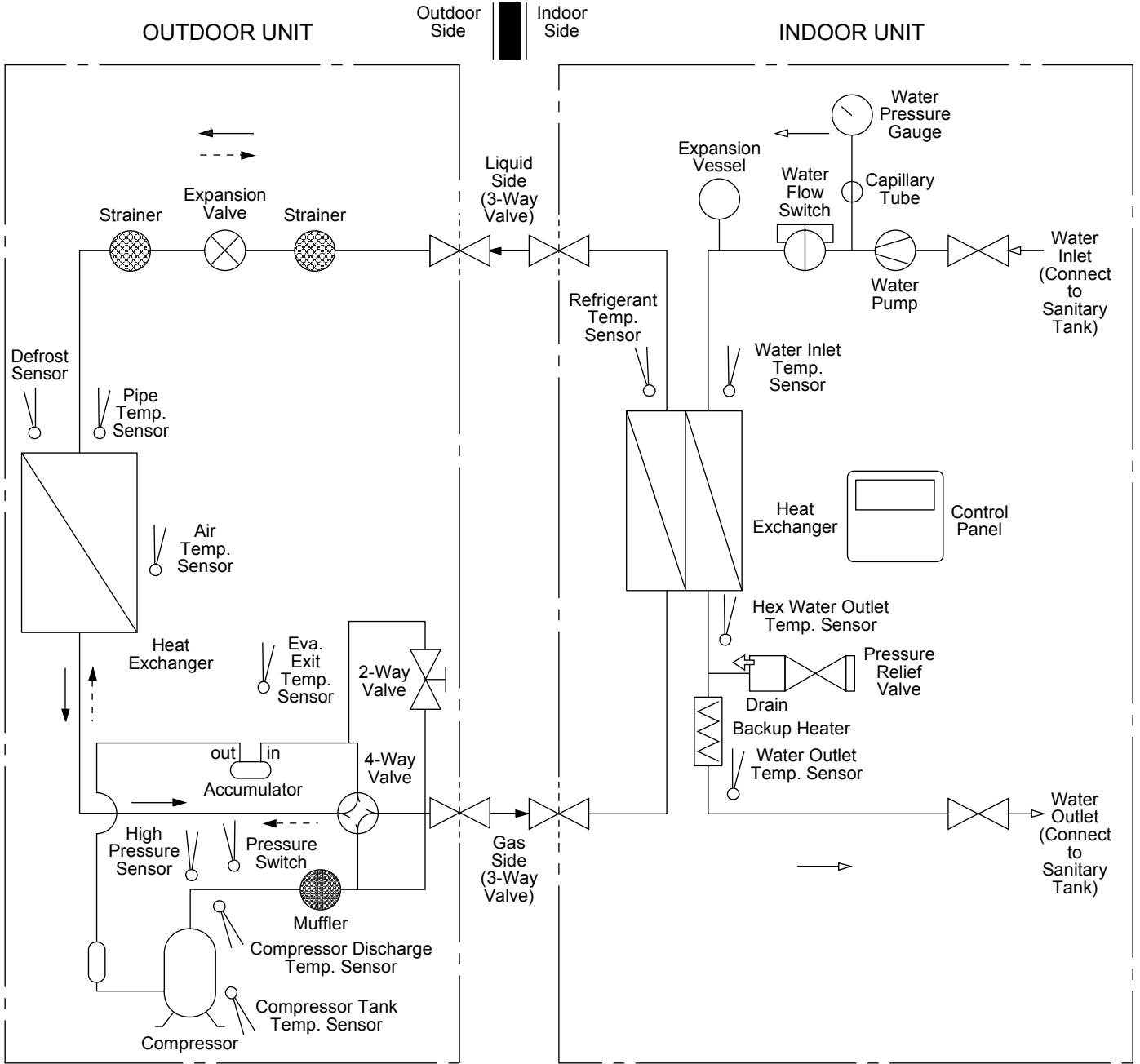

- ▶ Refrigerant Cycle (Heating)
- ▶ Water Cycle
- - -▶ Refrigerant Cycle (Cooling)

Model	Piping size		Rated Length (m)	Max Elevation (m)	Min. Piping Length (m)	Max. Piping Length (m)	Additional Refrigerant (g/m)
	Gas	Liquid					
WH-SDC09F3E8 WH-UD09FE8	Ø15.88 mm (5/8")	Ø9.52 mm (3/8")	5 ~ 7.5	20	3	30	50
WH-SDC12F9E8 WH-UD12FE8							
WH-SDC14/16F9E8 WH-UD14/16FE8							

\* If piping length is over common length, additional refrigerant should be added as shown in the table.

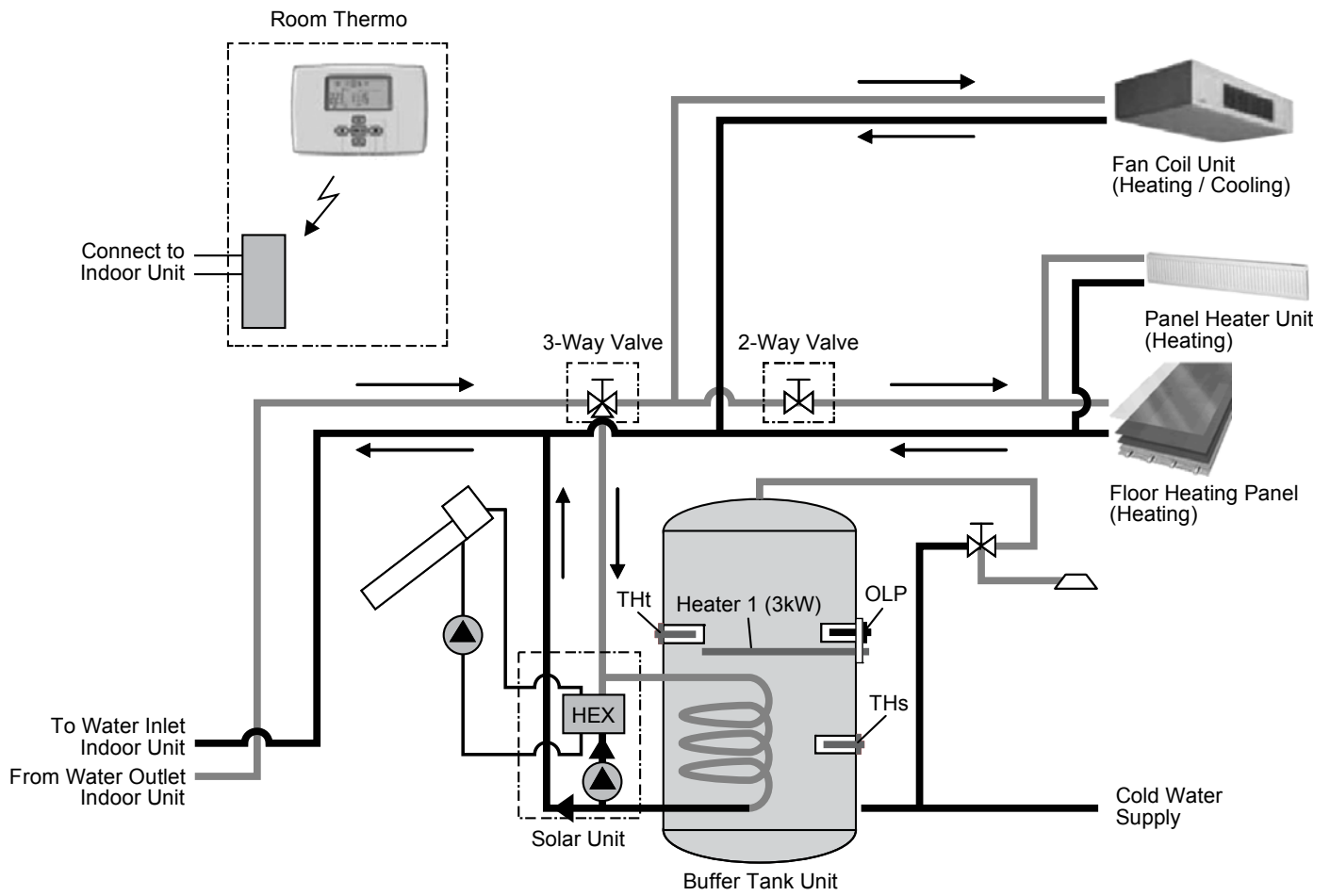



# 7. Block Diagram

## 7.1 WH-SDC09F3E8 WH-UD09FE8

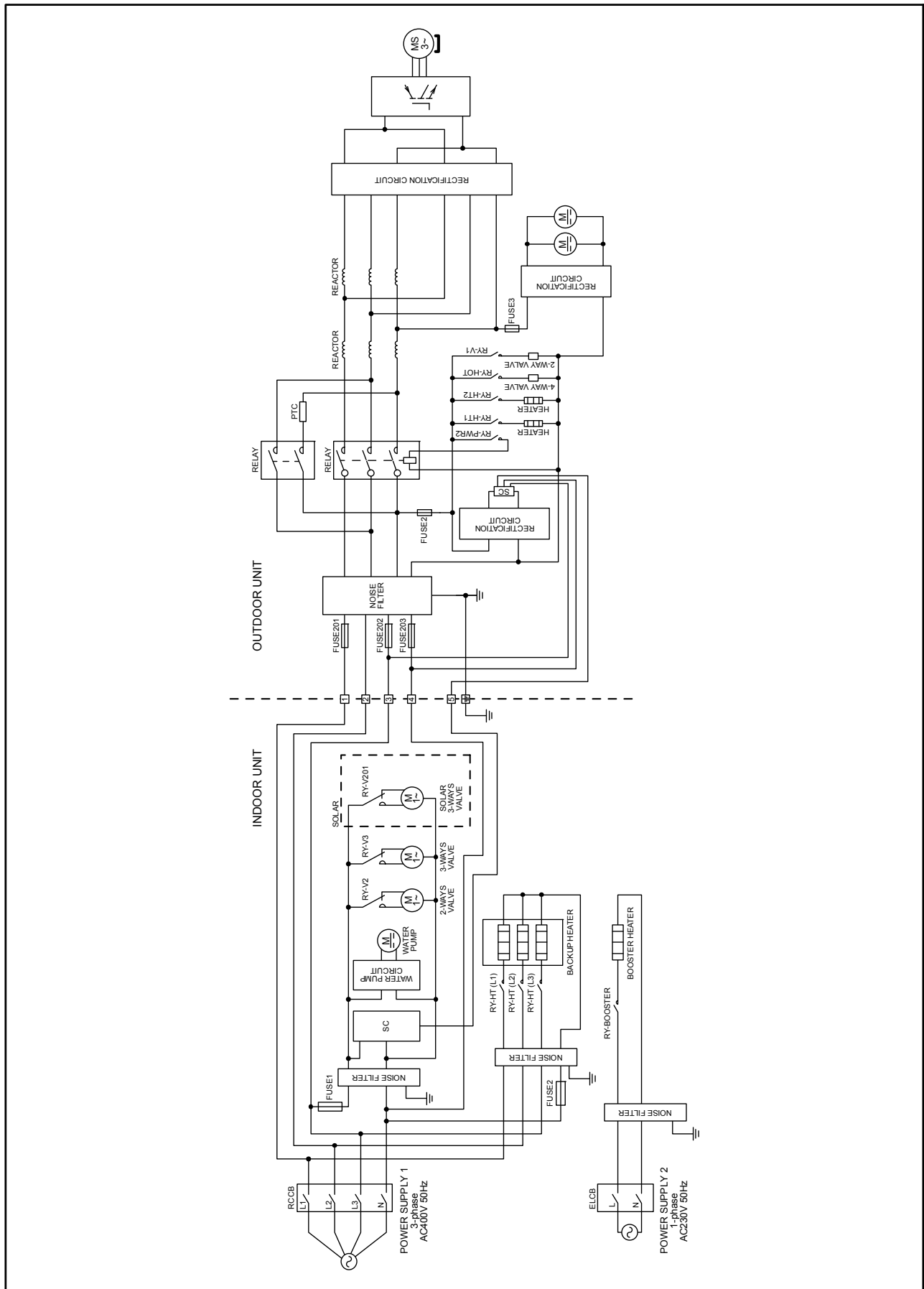







## 8.2 Outdoor Unit

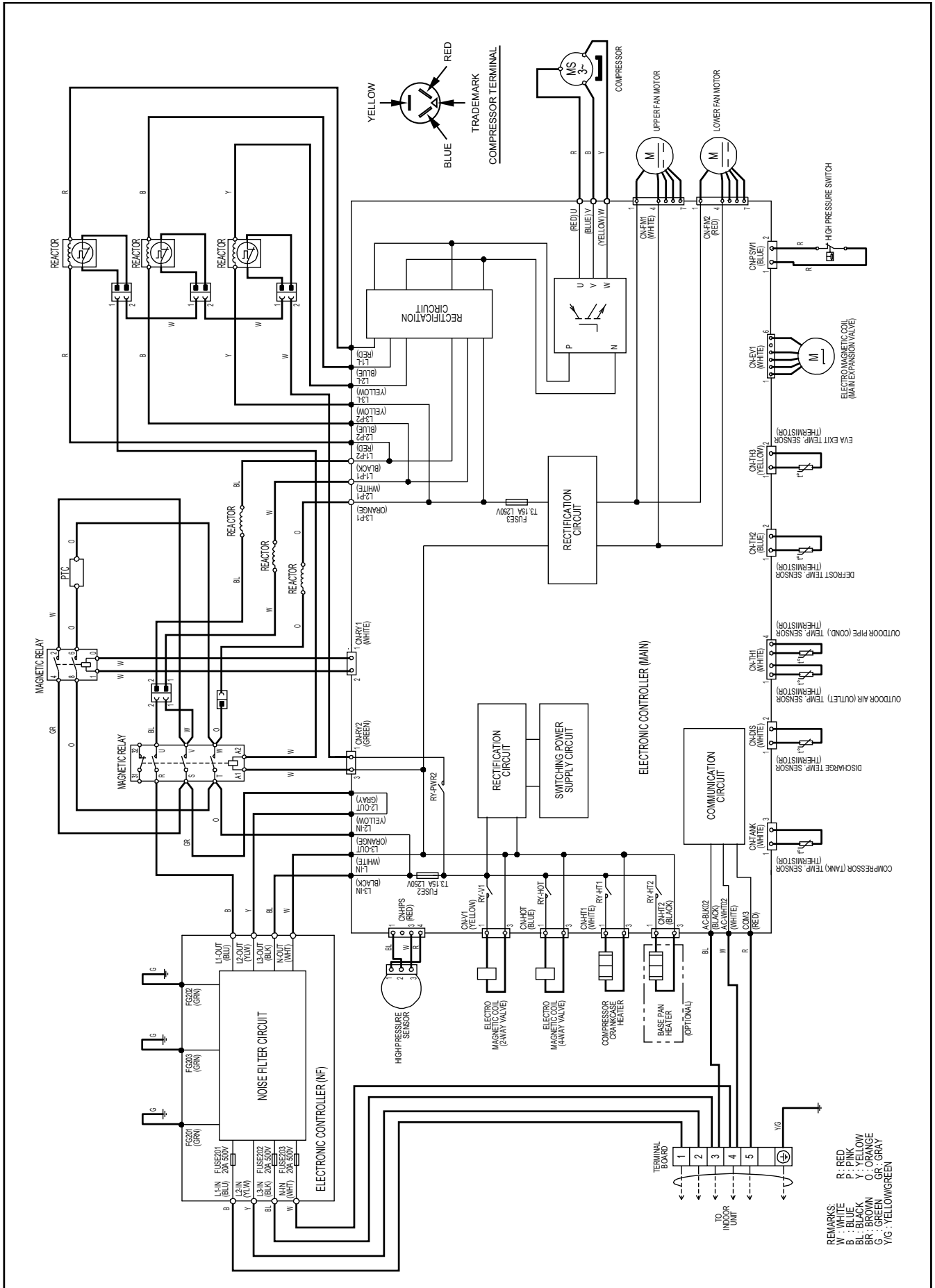

# 9. Electronic Circuit Diagram

## 9.1 Indoor Unit

### 9.1.1 WH-SDC09F3E8

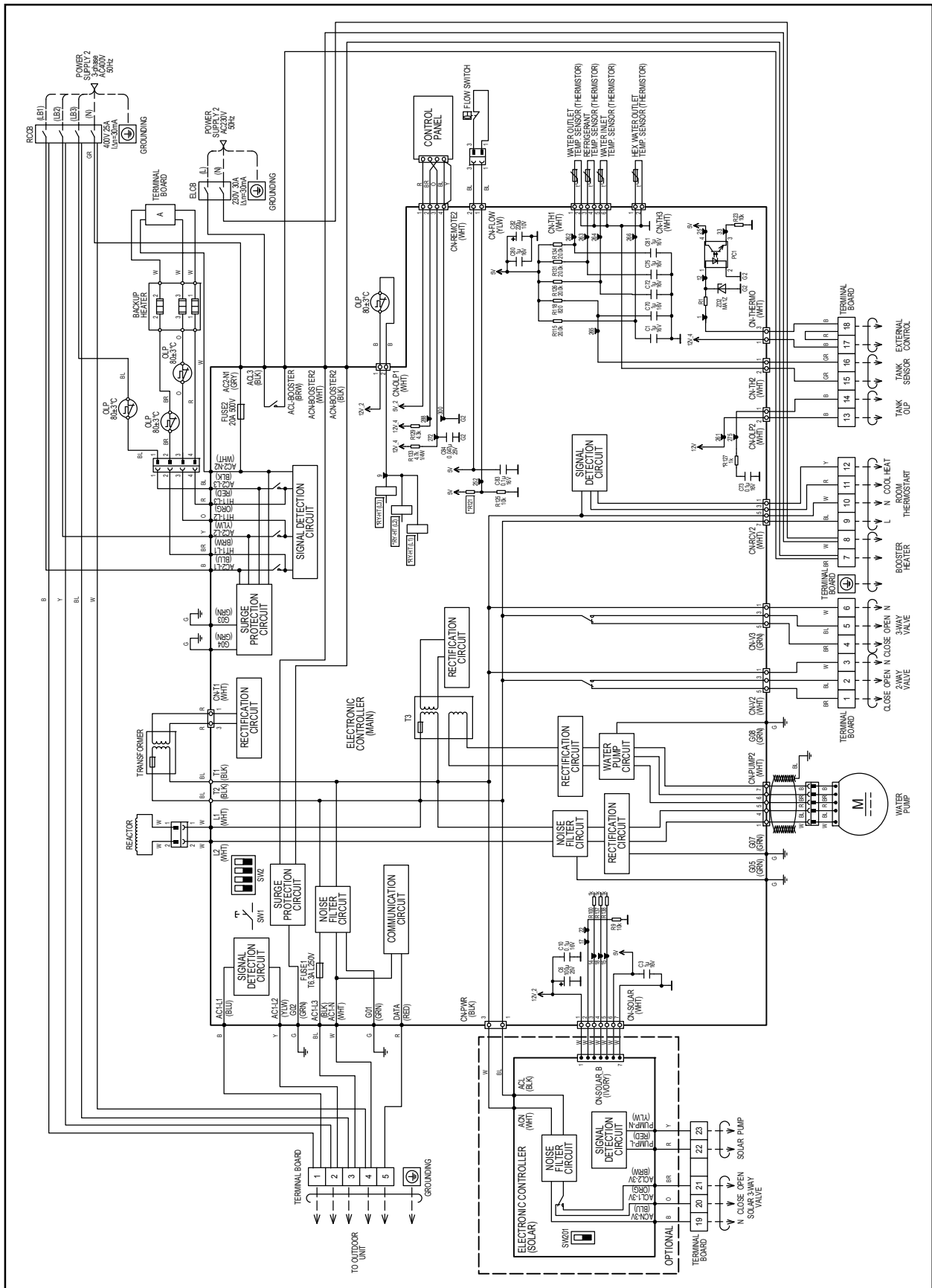

# 9.1.2 WH-SDC12F9E8 WH-SDC14F9E8 WH-SDC16F9E8

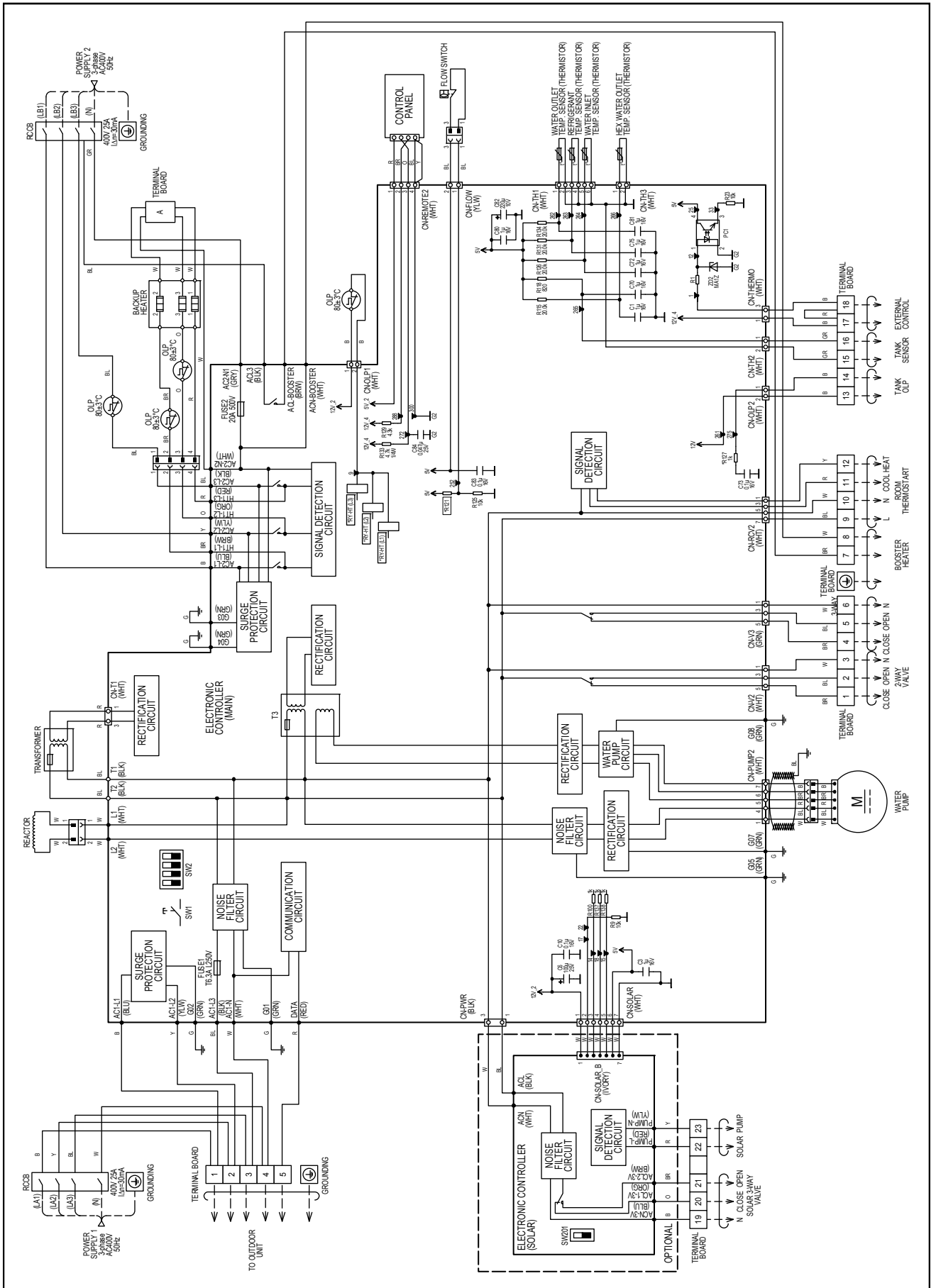

# 9.2 Outdoor Unit

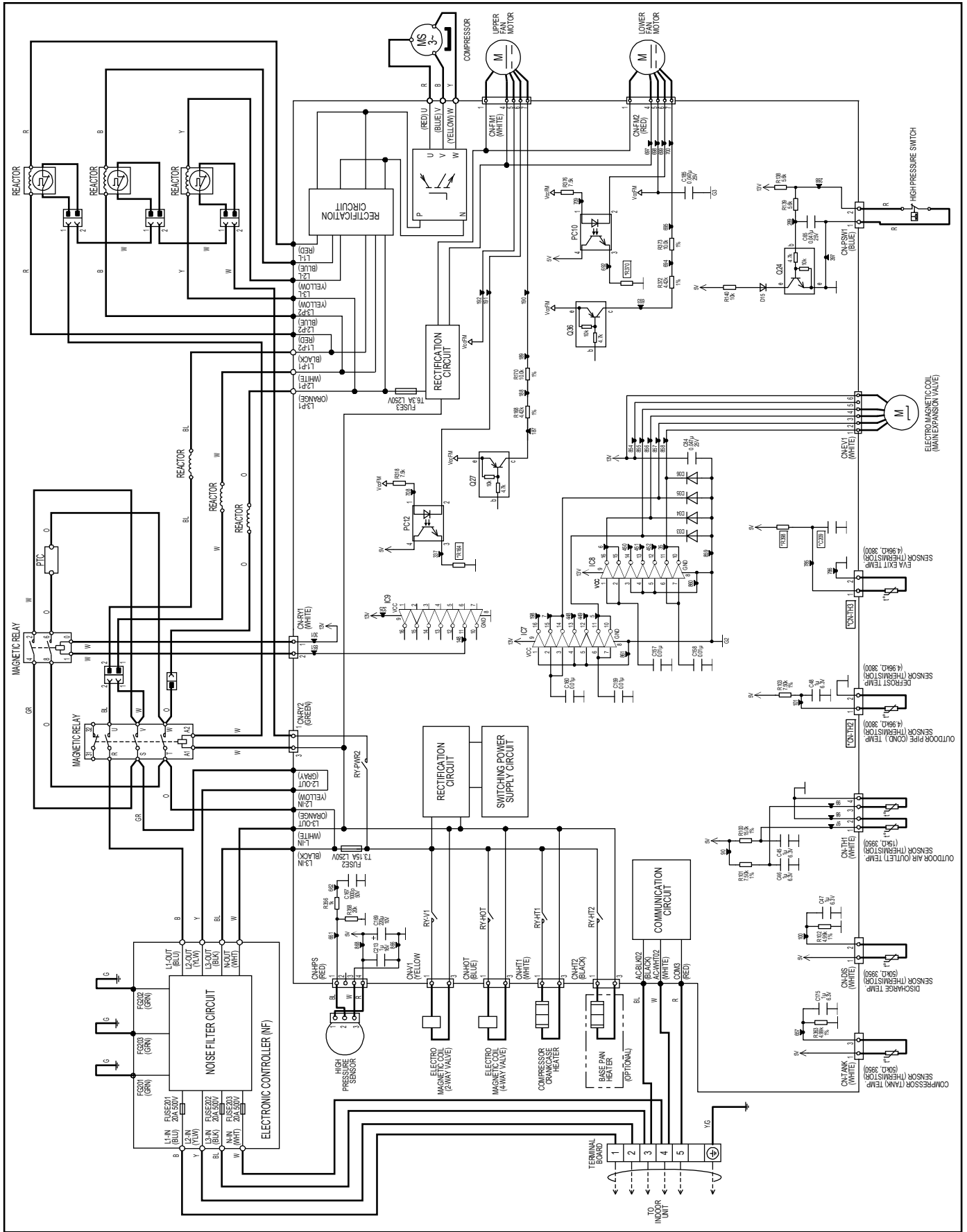



# 10. Printed Circuit Board

## 10.1 Indoor Unit

### 10.1.1 Main Printed Circuit Board

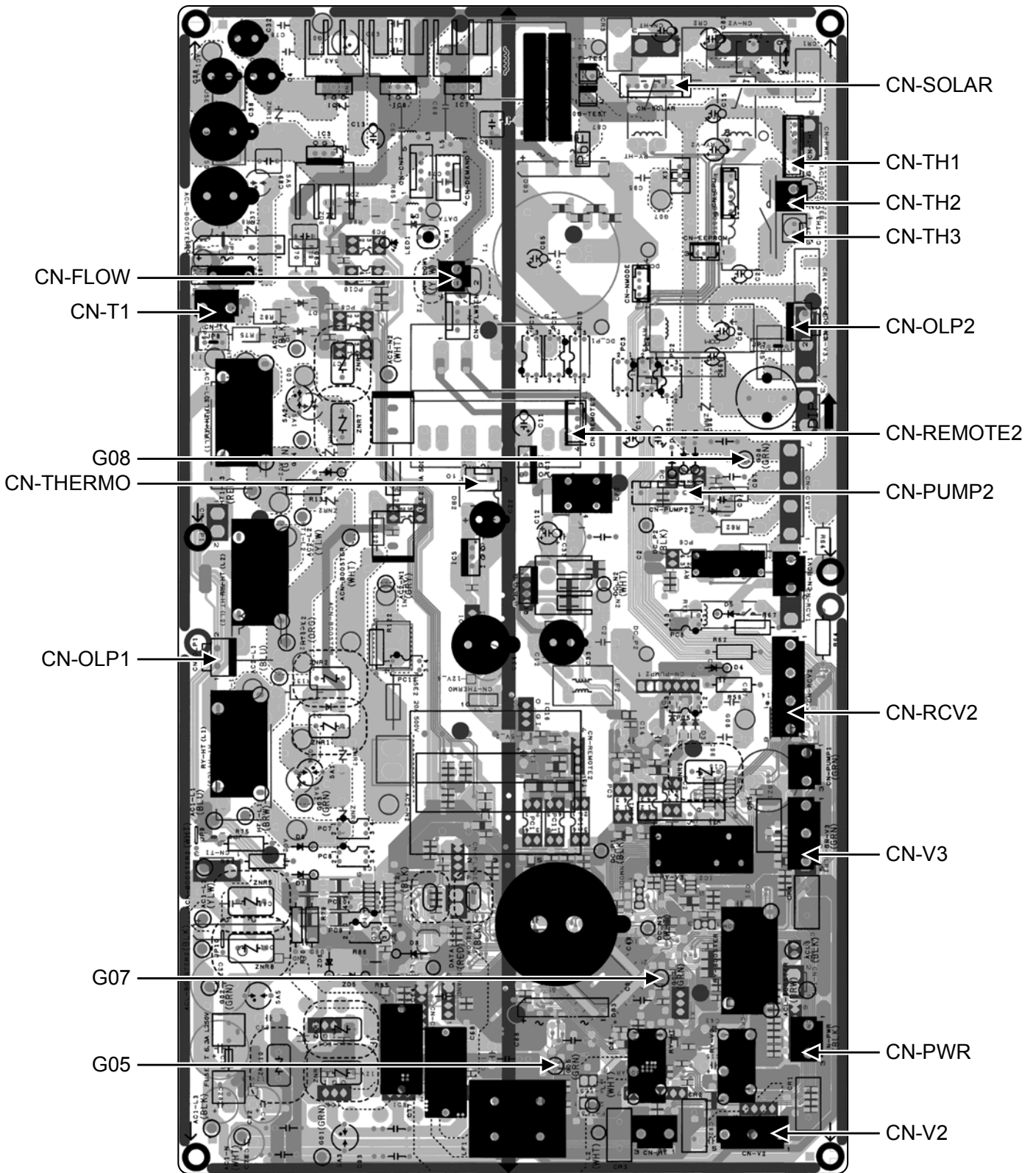

### 10.1.2 Solar Printed Circuit Board (Optional)

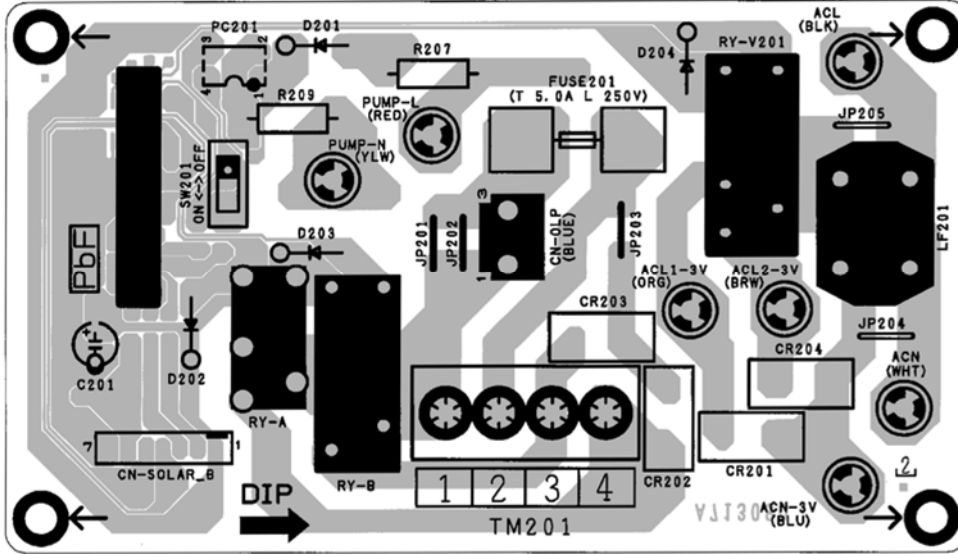

## 10.2 Outdoor Unit

### 10.2.1 Main Printed Circuit Board

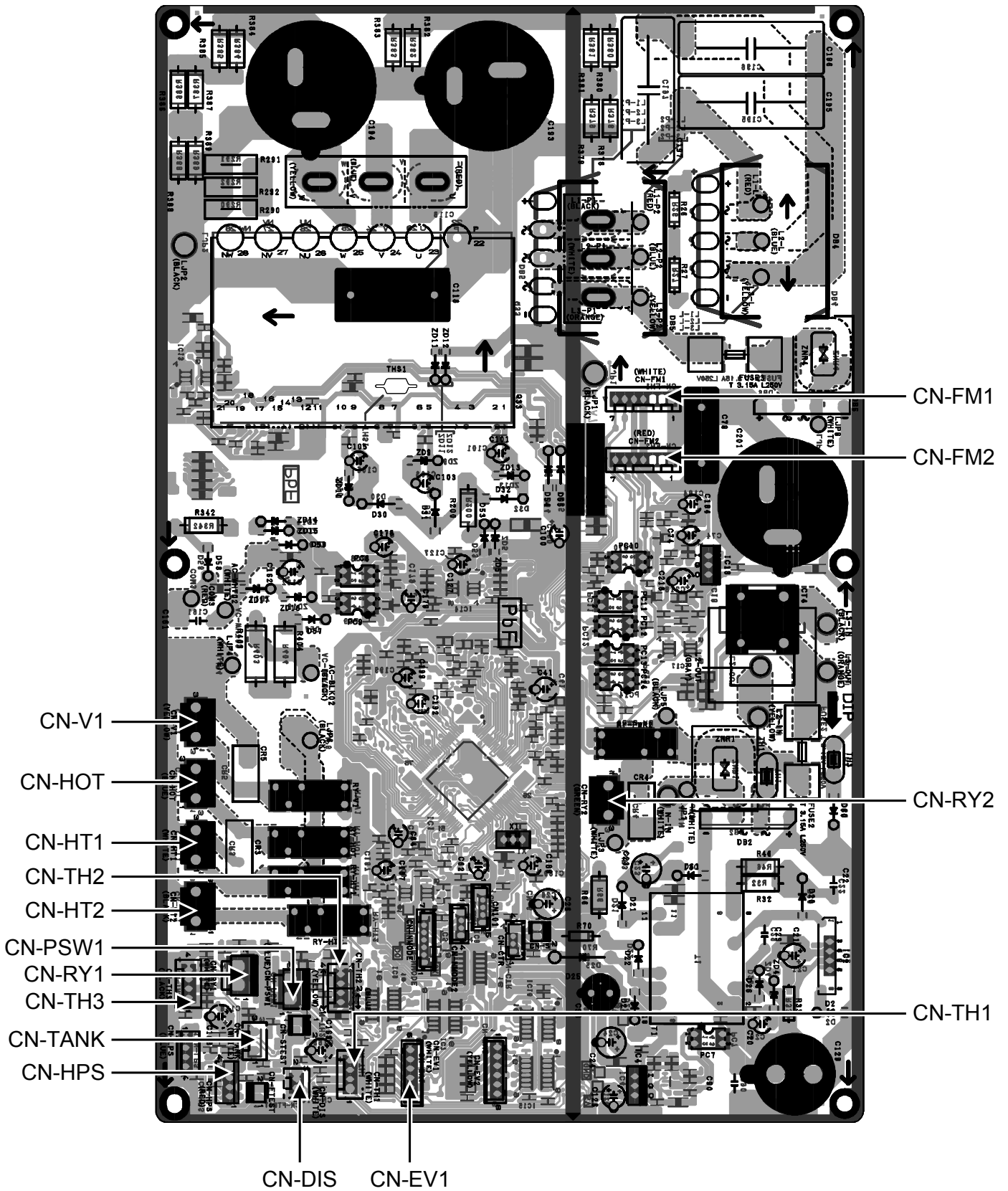

## 10.2.2 Noise Filter Printed Circuit Board

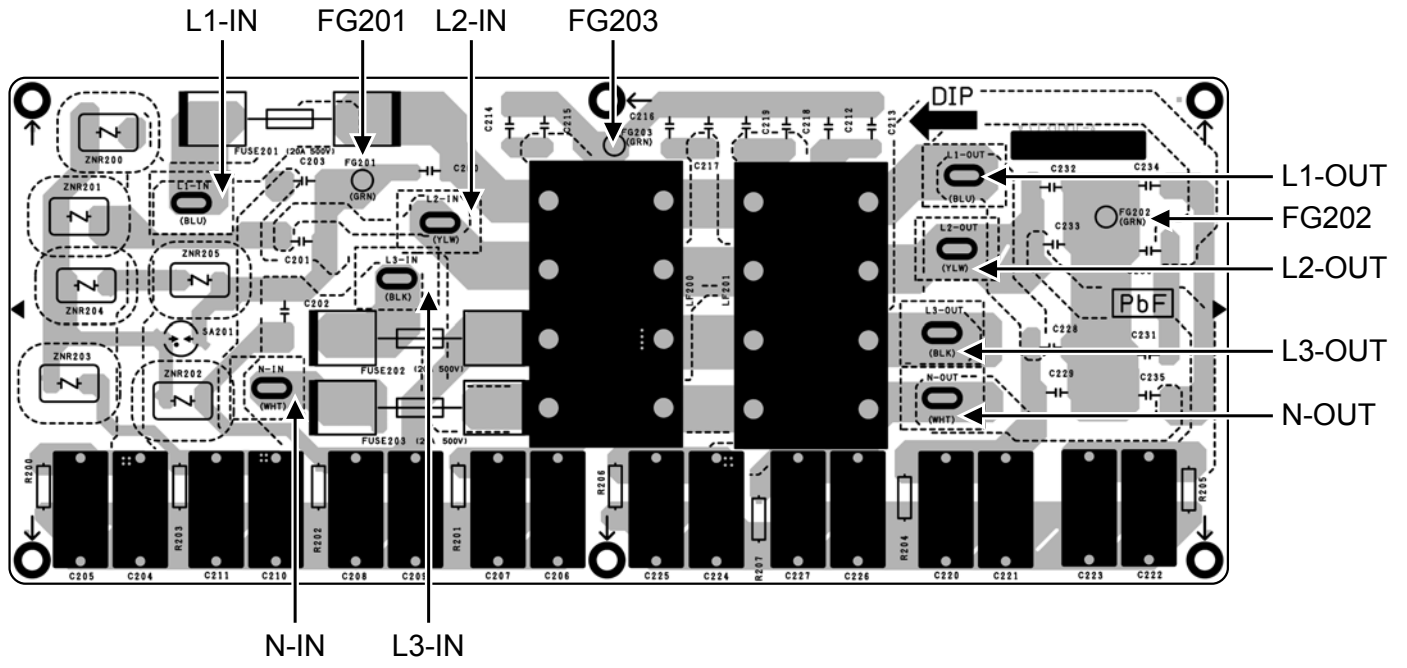

# 11. Installation Instruction

## 11.1 Select the Best Location

### INDOOR UNIT

- There should not be any heat source or steam near the unit.
- A place where air circulation in the room is good.
- A place where drainage can be easily done.
- A place where noise prevention is taken into consideration.
- Do not install the unit near the door way.
- Ensure the spaces indicated by arrows from the wall, ceiling, fence or other obstacles.
- Recommended installation height for indoor unit shall be at least 800 mm.
- Must install on a vertical wall.
- When install electrical equipment at wooden building of metal lath or wire lath, according to electrical facility technical standard, no electrical contact between equipment and building is allowed. Insulator must be installed in between.
- Do not install the unit at outdoor. This is designed for indoor installation only.
- When connecting solar pump station cable between indoor unit and solar pump station, the distance between both apparatuses shall be 2 ~ 8 meters and the maximum length of 10 meter only. Failure to do so may lead to abnormal operation to the system.

### OUTDOOR UNIT

- If an awning is built over the unit to prevent direct sunlight or rain, be careful that heat radiation from the condenser is not obstructed.
- Avoid installations in areas where the ambient temperature may drop below -20°C.
- Keep the spaces indicated by arrows from wall, ceiling, fence or other obstacles.
- Do not place any obstacles which may cause a short circuit of the discharged air.
- If outdoor unit installed near sea, region with high content of sulphur or oily location (e.g. machinery oil, etc), it lifespan maybe shorten.
- When installing the product in a place where it will be affected by typhoon or strong wind such as wind blowing between buildings, including the rooftop of a building and a place where there is no building in surroundings, fix the product with an overturn prevention wire, etc. (Overturn prevention fitting model number: K-KYZP15C)

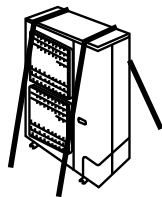

- If piping length is over 10 m, additional refrigerant should be added as shown in the table.

Model	Piping size		Standard Length (m)	Max. Elevation (m)	Min. Piping Length (m)	Max. Piping Length (m)	Additional Refrigerant (g/m)
	Gas	Liquid					
WH-SDC09F3E8 WH-UD09FE8	ø15.88mm (5/8")	ø9.52mm (3/8")	5~7.5	20	3	30	50
WH-SDC12F9E8 WH-UD12FE8							

Example :

If piping length is 30 m, the quantity of additional refrigerant should be 1000 g. [(30-10)m × 50 g/m = 1000 g]

## 11.2 Indoor/Outdoor Unit Installation Diagram

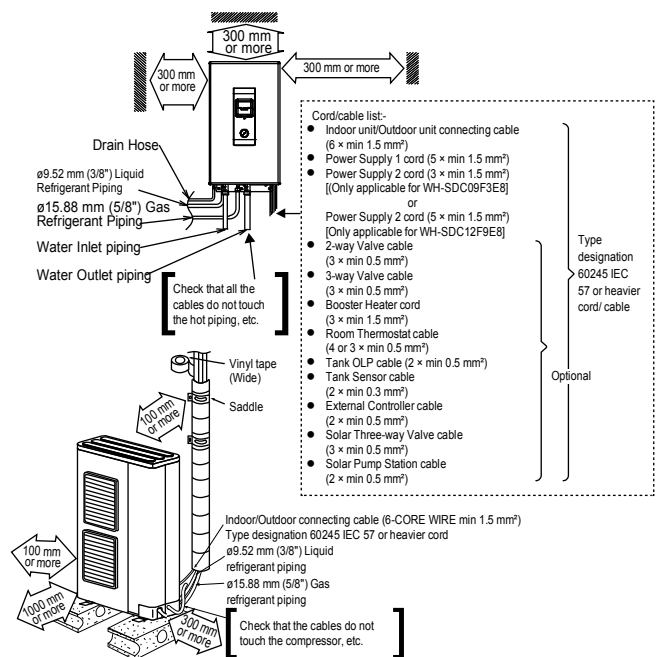

It is advisable to avoid more than 2 blockage directions. For better ventilation & multiple-outdoor installation, please consult authorized dealer/specialist.

- This illustration is for explanation purposes only. The indoor unit will actually face a different way.

## 11.3 Indoor Unit

### 11.3.1 How to Fix Installation Plate

The mounting wall is strong and solid enough to prevent it from vibration.

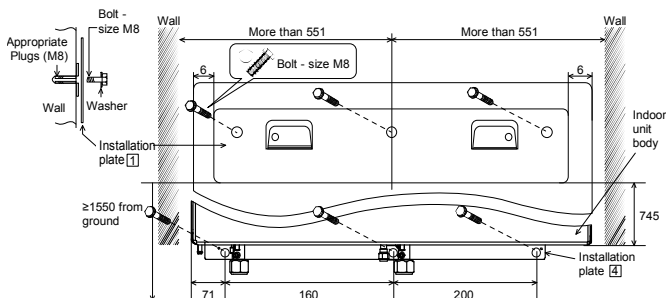

The centre of installation plate should be at more than 551 mm at right and left of the wall.

The distance from installation plate edge to ground should more than 1550 mm.

- Always mount the installation plate horizontally by aligning the marking thread and using a level gauge.
- Mount the installation plate on the wall with 6 sets of plug, bolt and washer (all non-supply) with size M8.

### 11.3.2 To Drill a Hole in the Wall and Install a Sleeve of Piping

- 1 Insert the piping sleeve to the hole.
- 2 Fix the bushing to the sleeve.
- 3 Cut the sleeve until it extrudes about 15 mm from the wall.

#### CAUTION

When the wall is hollow, please be sure to use the sleeve for tube assembly to prevent dangers caused by mice biting the connecting cable.

- 4 Finish by sealing the sleeve with putty or caulking compound at the final stage.

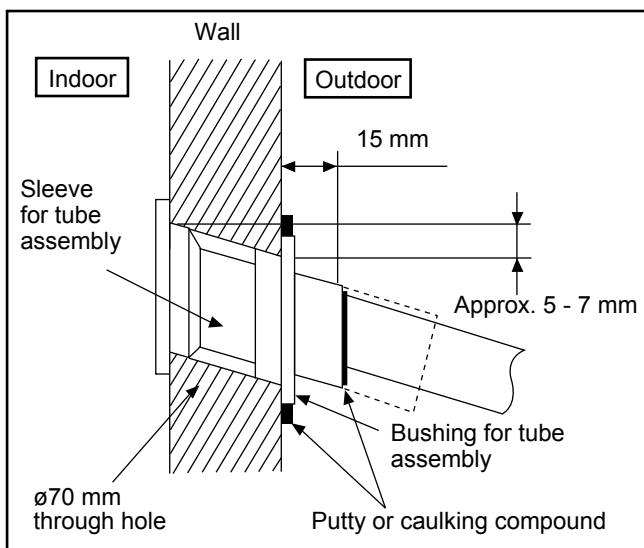

### 11.3.3 Indoor Unit Installation

#### 11.3.3.1 Install the Indoor Unit

- 1 When connecting solar pump station cable between indoor unit and solar pump station, the distance between both apparatuses shall be 2 ~ 8 meters and the maximum length of 10 meter only. Failure to do so may lead to abnormal operation to the system.
- 2 Engage the slots on the indoor unit to the hooks of installation plate (1). Ensure the hooks are properly seated on the installation plate by moving it left and right.
- 3 Fix the screws (3) to the holes on the hooks of installation plate, (4), as illustrated below.

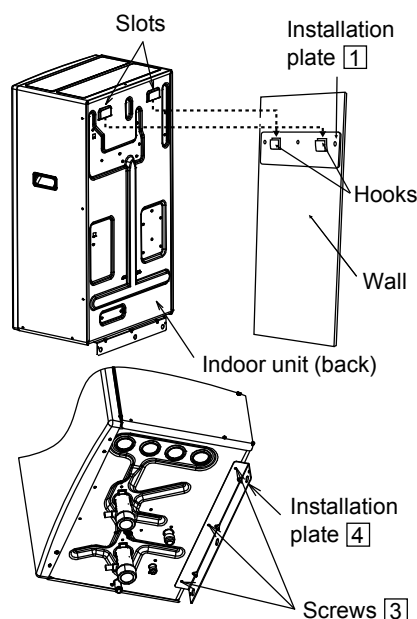

#### 11.3.3.2 Water Piping Installation

- The minimum requirement of water in the system is 50 litres. If this value could not be achieved, please install additional buffer tank (field supply).
- Water inlet and water outlet in indoor unit are used for connection to water circuit. Please request a licensed technician to install this water circuit.
- This water circuit must comply with all relevant European and national regulations, i.e. IEC/EN 61770.
- Be careful not to deform the piping with excessive force when doing piping connection job.
- Use Rp 1 1/4" nut for both water inlet and outlet connection and clean all pipings with tap water before connecting to the indoor unit.
- Cover the pipe end to prevent dirt and dust when inserting it through a wall.
- Choose proper sealer which can withstand the pressures and temperatures of the system.
- If an existing tank is to be connected to this indoor/outdoor unit, ensure the pipes are clean before water pipe installation is carried out.

- An external filter (30 mesh or more, field supplied) must be installed before the water inlet of the indoor unit (with "WATER IN" indication).
- Refer to Diagram 4.1 for pipe connection of Radiator, Floor Heater, Tank Unit, Solar Pump Station, 3-way Valve Kit, 2-way Valve Kit and etc. Fail to connect the pipes appropriately might cause the unit malfunction.

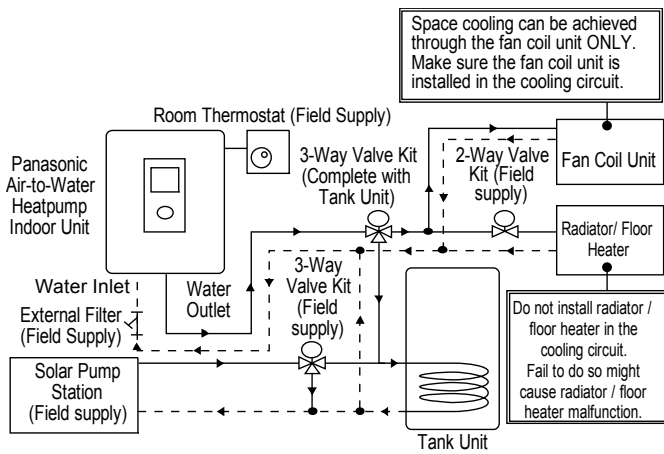
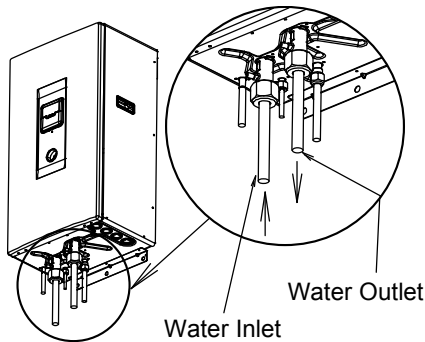

Diagram 4.1: Typical Water Piping Installation

- Be sure to use two spanners to tighten the connection. Tighten the nuts with torque wrench: 117.6 N•m.
- If non-brass metallic piping is used for installation, make sure to insulate the pipes to prevent galvanic corrosion.
- Make sure to insulate the water circuit pipes to prevent reduction of heating capacity.
- After installation, check the water leakage condition in connection area during test run.



**CAUTION**  
Do not over tighten, over tightening cause water leakage.

### 11.3.3.3 Insulation

- Mount the PS foam [7] and long banding strap [8] to water inlet and outlet connectors, as shown in below illustration.

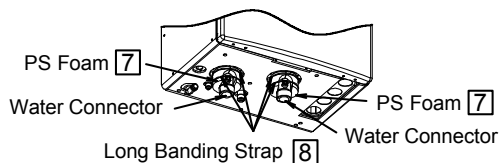

### 11.3.3.4 Indoor Unit Refrigerant Pipe Installation

- 1 Please make flare after inserting flare nut (located at joint portion of tube assembly) onto the copper pipe. (In case of using long piping)
- 2 Do not use pipe wrench to open refrigerant piping. Flare nut may be broken and cause leakage. Use proper spanner or ring wrench.
- 3 Connect the piping:
  - Align the center of piping and sufficiently tighten the flare nut with fingers.
  - Further tighten the flare nut with torque wrench in specified torque as stated in the table.

Model	Piping size (Torque)	
	Gas	Liquid
WH-SDC09F3E8 WH-UD09FE8	ø15.88 mm (5/8") [65 N•m]	ø9.52 mm (3/8") [42 N•m]
WH-SDC12F9E8 WH-UD12FE8		

**CAUTION**  
Do not over tighten, over tightening cause gas leakage.

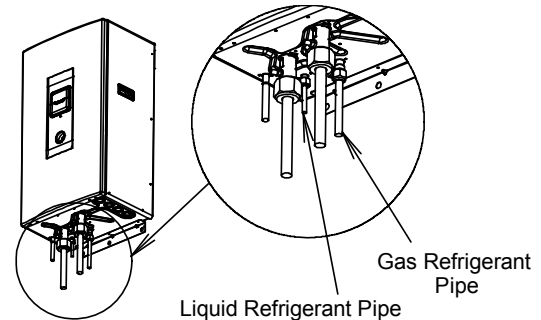

### 11.3.3.5 Drain Hose Installation

- Use inner diameter 15 mm drain hose in the market.
- This hose must to be installed in a continuously downward direction and in a frost-free environment.
- Do not insert this hose into sewage or drain pipe that may generate ammonia gas, sulfuric gas, etc.
- If necessary, use hose clamp to further tighten the hose at drain hose connector to prevent leakage.
- Water will drip from this hose, therefore the outlet of this hose must be installed in an area where the outlet cannot become blocked.

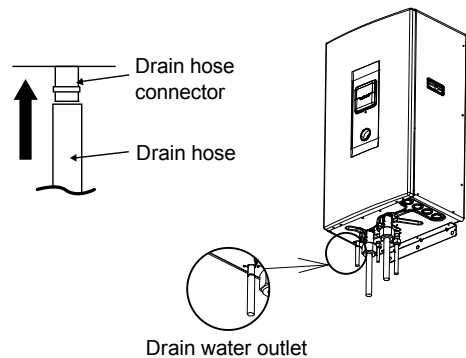

### 11.3.3.6 Drain Elbow and Hose Installation

- Fix the drain elbow ⑩ and packing ⑨ to the bottom of indoor unit, as shown in below illustration.
- Use inner diameter 17 mm drain hose in the market.
- This hose must be installed in a continuously downward direction and in a frost-free environment.
- Guides this hose's outlet to outdoor only.
- Do not insert this hose into sewage or drain pipe that may generate ammonia gas, sulfuric gas, etc.
- If necessary, use hose clamp to further tighten the hose at drain hose connector to prevent leakage.

- Water will drip from this hose, therefore the outlet of this hose must be installed in an area where the outlet cannot become blocked.

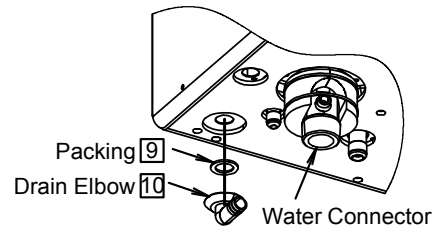

### 11.3.4 Connect the Cable to the Indoor Unit

- Connecting cable between indoor unit and outdoor unit shall be approved polychloroprene sheathed  $6 \times \min 1.5 \text{ mm}^2$  flexible cord, type designation 60245 IEC 57 or heavier cord.
    - Ensure the colour of wires of outdoor unit and the terminal no. are the same to the indoor unit's respectively.
    - Earth wire shall be longer than the other wires as shown in the figure for the electrical safety in case of the slipping out of the cord from the Holder (Clamper).
  - An isolating device must be connected to the power supply cable.
    - Isolating device (Disconnecting means) should have minimum 3.0 mm contact gap.
    - Connect the approved polychloroprene sheathed as below, type designation 60245 IEC 57 or heavier cord to the terminal board, and to the other end of the cord to isolating device (Disconnecting means).
      - Power supply 1 cord ( $5 \times \min 1.5 \text{ mm}^2$ )
      - Power supply 2 cord ( $3 \times \min 1.5 \text{ mm}^2$ ) (Only applicable for WH-SDC09F3E8)
- or
- Power supply 2 cord ( $5 \times \min 1.5 \text{ mm}^2$ ) (Only applicable for WH-SDC12F9E8)
- To avoid the cable and cord being damaged by sharp edges, the cable and cord must be passed through a bushing (located at the bottom of indoor unit) before being connected to the terminal block. The bushing must be used and must not be removed.

#### For model WH-SDC09F3E8

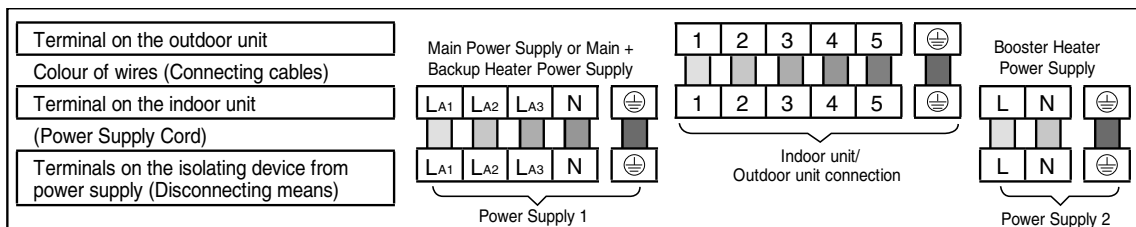

#### For model WH-SDC12F9E8

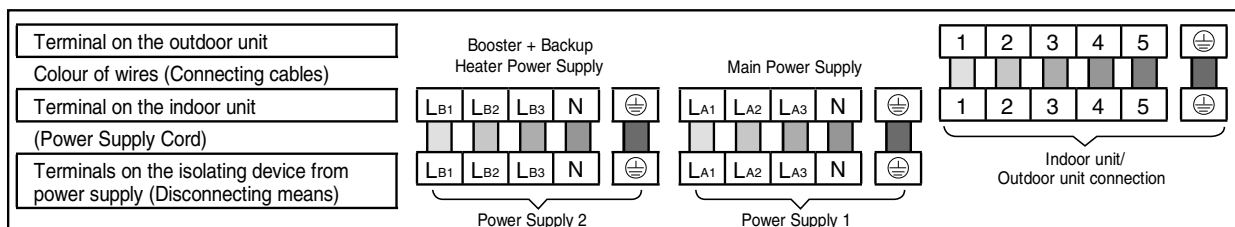

#### Connecting with external device (optional)

- All connections shall** follow to the local national wiring standard.
- It is strongly recommended to use manufacturer-recommended parts and accessories for installation.
- Maximum output power of booster heater shall be  $\leq 3 \text{ kW}$ . Booster Heater cord must be ( $3 \times \min 1.5 \text{ mm}^2$ ), of type designation 60245 IEC 57 or heavier.
- Two-way Valve shall be spring and electronic type, refer to "Field Supply Accessories" table for details. Valve cable shall be ( $3 \times \min 0.5 \text{ mm}^2$ ), of type designation 60245 IEC 57 or heavier, or similarly double insulation sheathed cable.



- \* note: - Two-way Valve shall be CE marking compliance component.  
- Maximum load for the valve is 9.8 VA.
- 5 Three-Way Valve shall be spring and electronic type. Valve's cable shall be (3 × min 0.5 mm<sup>2</sup>), of type designation 60245 IEC 57 or heavier, or similarly double insulation sheathed cable.  
\* note: - Shall be CE marking compliance component.  
- It shall be directed to heating mode when it is OFF.  
- Maximum load for the valve is 9.8 VA.
- 6 Room Thermostat cable must be (4 or 3 × min 0.5 mm<sup>2</sup>), double insulation layer of PVC-sheathed or rubber-sheathed cable.
- 7 Tank OLP cable must be (2 × min 0.5 mm<sup>2</sup>), double insulation layer of PVC-sheathed or rubber-sheathed cable.  
\* note: - if such connection deemed NO necessary for tank OLP, please connect jumper between terminal no. 13 and 14.
- 8 Tank Sensor shall be resistance type, please refer to Graph 5.1 for the characteristic and details of sensor. Its cable shall be (2 × min 0.3 mm<sup>2</sup>), double insulation layer (with insulation strength of min 30 V) of PVC-sheathed or rubber-sheathed cable.
- 9 External Controller shall be connected to 1-pole switch with min 3.0mm contact gap. (connection refer to Diagram 5.2). Its cable must be (2 × min 0.5 mm<sup>2</sup>), double insulation layer of PVC-sheathed or rubber-sheathed cable.  
\* note: - When making such connection, kindly remove the jumper between terminal no. 17 and 18.  
- Switch used shall be CE compliance component.  
- Maximum operating current shall be less than 3A<sub>rms</sub>.
- 10 Must install Solar Connection PCB (optional) to indoor unit when Solar Pump Station is utilized. Refer Solar Connection PCB's installation instruction for detail of installation.
- 11 Solar Three-way Valve cable shall be (3 × min 0.5 mm<sup>2</sup>), double insulation layer PVC-sheathed or rubber-sheathed cable.
- 12 Solar Pump Station cable shall be (2 × min 0.5 mm<sup>2</sup>), of double insulation PVC-sheathed or rubber-sheathed cable. Strongly recommended install with maximum length of 10 meter only.

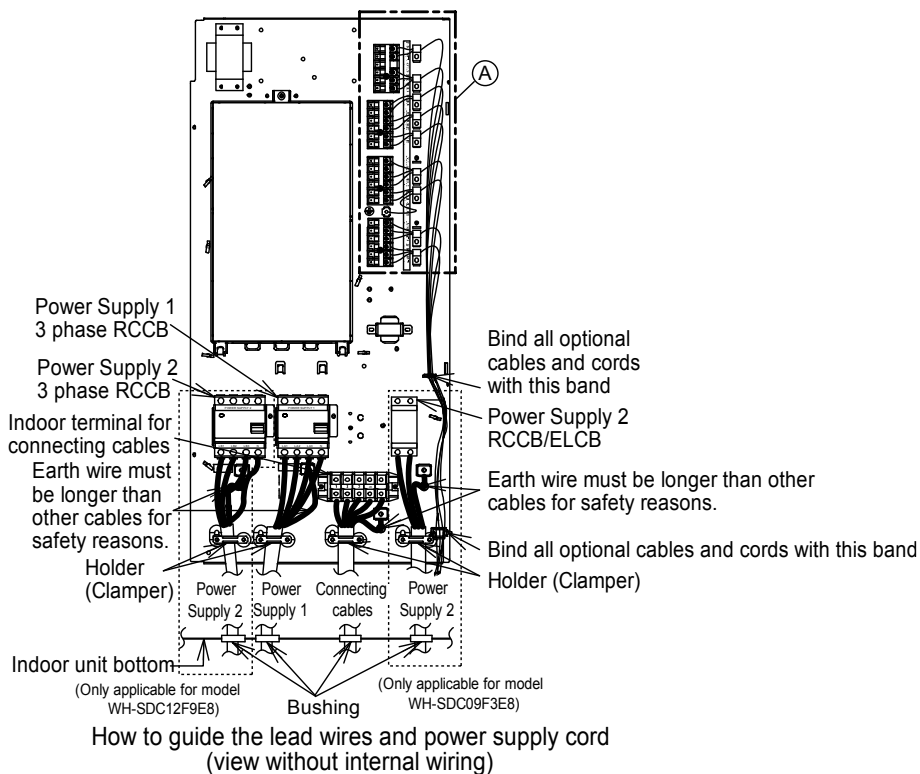
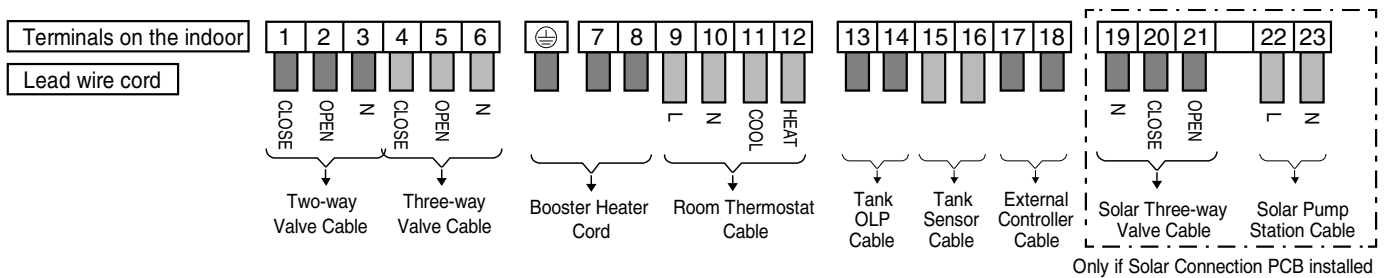

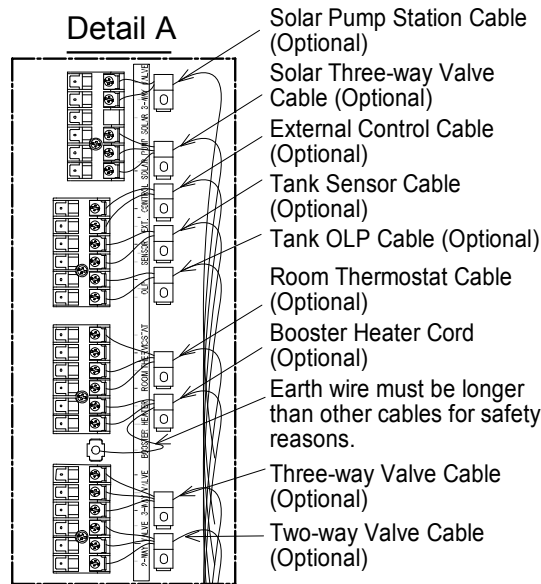

### 11.3.4.1 Wire Stripping and Connecting Requirement

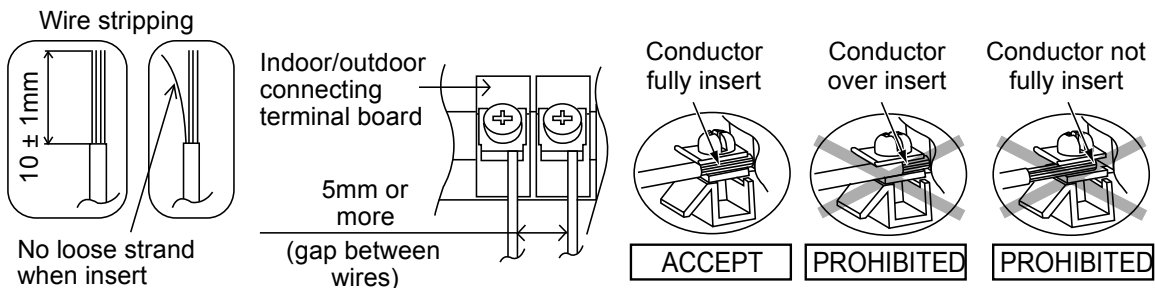

Tank Sensor Resistance Vs Temperature

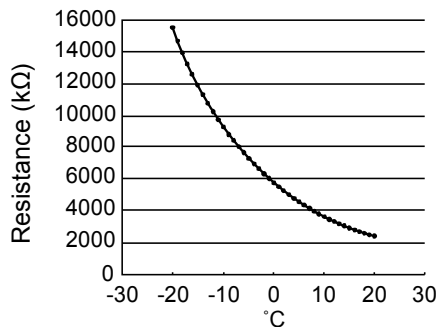

Graph 5.1: Tank sensor characteristic

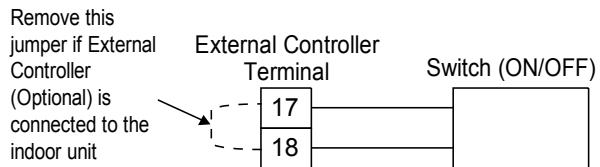

Diagram 5.2: External Controller connecting diagram

### 11.3.4.2 Connecting Requirement

#### For model WH-SDC09F3E8

- The equipment's power supply 1 complies with IEC/EN 61000-3-2.
- The equipment's power supply 2 complies with IEC/EN 61000-3-2.

#### For model WH-SDC12F9E8

- The equipment's power supply 1 complies with IEC/EN 61000-3-2.
- The equipment's power supply 2 complies with IEC/EN 61000-3-2.
- The equipment's power supply 2 shall be connected to a suitable supply network, with the following maximum permissible system impedance  $Z_{max}$  at the interface of the point: 0.449  $\Omega$ . Please liaise with supply authority to ensure that power supply 2 is connected to a supply of the impedance or less.

## 11.4 Outdoor Unit

### 11.4.1 Install the Outdoor Unit

- After selecting the best location, start installation according to Indoor/Outdoor Unit Installation Diagram.
  - Fix the unit on concrete or rigid frame firmly and horizontally by bolt nut ( $\varnothing 10$  mm).
  - When installing at roof, please consider strong wind and earthquake. Please fasten the installation stand firmly with bolt or nails.

(Unit in mm)

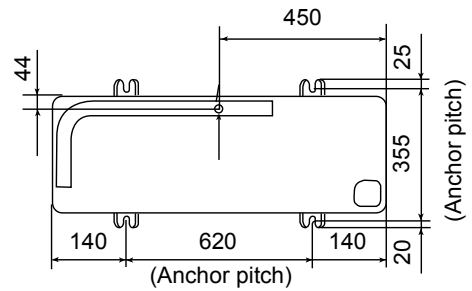

### 11.4.2 CONNECTING THE PIPING

Model	Piping size (Torque)	
	Gas	Liquid
WH-SDC09F3E8 WH-UD09FE8	$\varnothing 15.88$ mm (5/8") [65 N•m]	$\varnothing 9.52$ mm (3/8") [42 N•m]
WH-SDC12F9E8 WH-UD12FE8		

**CAUTION**  
Do not over tighten, over tightening cause gas leakage.

#### Connecting The Piping To Outdoor Unit

Decide piping length and then cut by using pipe cutter. Remove burrs from cut edge. Make flare after inserting the flare nut (locate at valve) onto the copper pipe.

Align center of piping to valves and then tighten with torque wrench to the specified torque as stated in the table.

Local pipes can project in any of four directions.

- Make holes in the pipe panels for the pipes to pass through.
- Be sure to install the pipe panels to prevent rain from getting inside the outdoor unit. [Removing the service panel].
  - Remove the three mounting screws.
  - Slide the service panel downward to release the pawls.

After this, pull the service panel toward you to remove it.

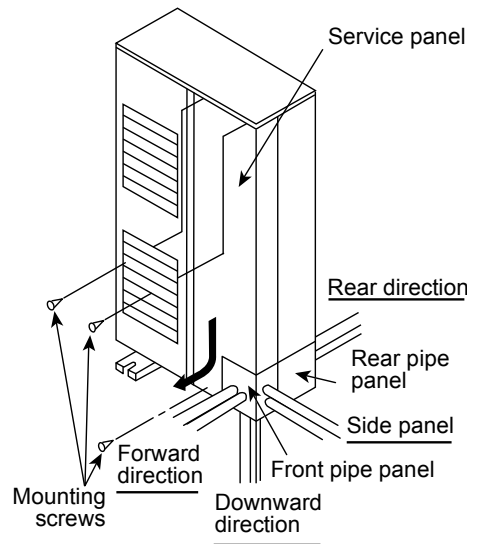

Be sure to use two spanners to tighten. (If the nuts are over tightened, it may cause the flares to break or leak.)

Do not attach the spanners here

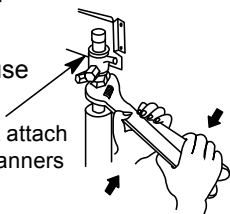

Close the tube joining area with putty heat insulator (local supply) without any gap as shown in right figure. (To prevent insects or small animal entering.)

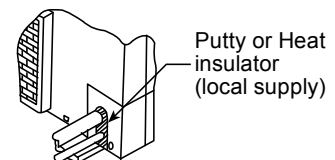

## CUTTING AND FLARING THE PIPING

- 1 Please cut using pipe cutter and then remove the burrs.
- 2 Remove the burrs by using reamer. If burrs is not removed, gas leakage may be caused. Turn the piping end down to avoid the metal powder entering the pipe.
- 3 Please make flare after inserting the flare nut onto the copper pipes.

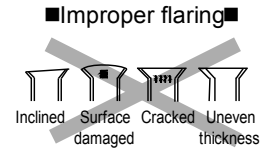
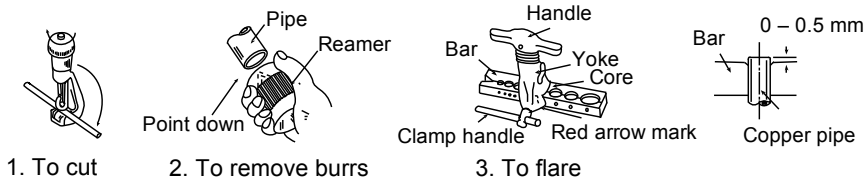

When properly flared, the internal surface of the flare will evenly shine and be of even thickness. Since the flare part comes into contact with the connections, carefully check the flare finish.

## 11.4.3 Evacuation of the Equipment

WHEN INSTALLING AN AIR-TO-WATER HEAT PUMP, BE SURE TO EVACUATE THE AIR INSIDE THE INDOOR UNIT AND PIPES in the following procedure.

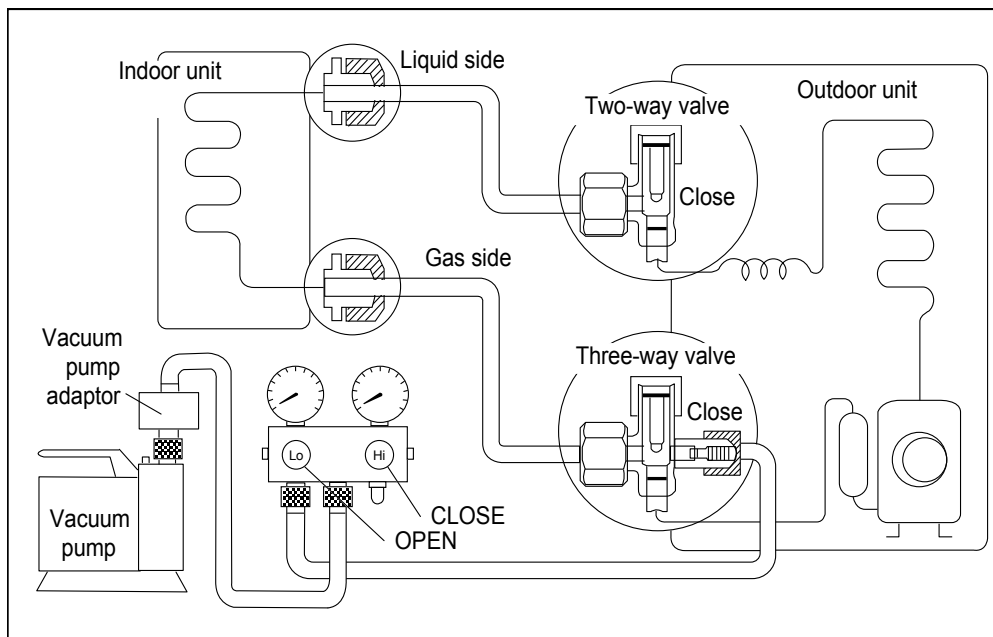

- 1 Connect a charging hose with a push pin to the Low side of a charging set and the service port of the 3-way valve.
  - o Be sure to connect the end of the charging hose with the push pin to the service port.
- 2 Connect the center hose of the charging set to a vacuum pump with check valve, or vacuum pump and vacuum pump adaptor.
- 3 Turn on the power switch of the vacuum pump and make sure that the needle in the gauge moves from 0 cmHg (0 MPa) to -76 cmHg (-0.1 MPa). Then evacuate the air approximately ten minutes.
- 4 Close the Low side valve of the charging set and turn off the vacuum pump. Make sure that the needle in the gauge does not move after approximately five minutes.
 

Note: BE SURE TO FOLLOW THIS PROCEDURE IN ORDER TO AVOID REFRIGERANT GAS LEAKAGE.
- 5 Disconnect the charging hose from the vacuum pump and from the service port of the 3-way valve.
- 6 Tighten the service port caps of the 3-way valve at a torque of 18 N·m with a torque wrench.
- 7 Remove the valve caps of both of the 2-way valve and 3-way valve. Position both of the valves to "OPEN" using a hexagonal wrench (4 mm).
- 8 Mount valve caps onto the 2-way valve and the 3-way valve.
  - o • Be sure to check for gas leakage.

### ⚠ CAUTION

If gauge needle does not move from 0 cmHg (0 MPa) to -76 cmHg (-0.1 MPa), in step ③ above take the following measure:

- If the leak stops when the piping connections are tightened further, continue working from step ③.
- If the leak does not stop when the connections are retightened, repair the location of leak.
- Do not release refrigerant during piping work for installation and reinstallation. Take care of the liquid refrigerant, it may cause frostbite.

### 11.4.4 Connect the Cable to the Outdoor Unit

(FOR DETAIL REFER TO WIRING DIAGRAM AT UNIT)

- 1 Remove the control board cover from the unit by loosening the screw.
- 2 Connecting cable between indoor unit and outdoor unit shall be approved polychloroprene sheathed (6 × min 1.5 mm<sup>2</sup>) flexible cord, type designation 60245 IEC 57 or heavier cord.

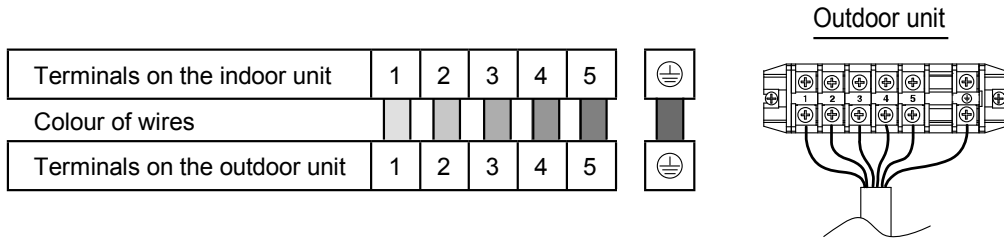

- 3 Secure the cable onto the control board with the holder (clammer).
- 4 Select required direction and apply protective bushing provided in accessories to protect cables from sharp edges.
- 5 Once all wiring work has been completed, tie the cables and cord together with the binding strap so that they do not touch other parts such as the compressor and bare copper pipes.
- 6 Install back the control board cover.

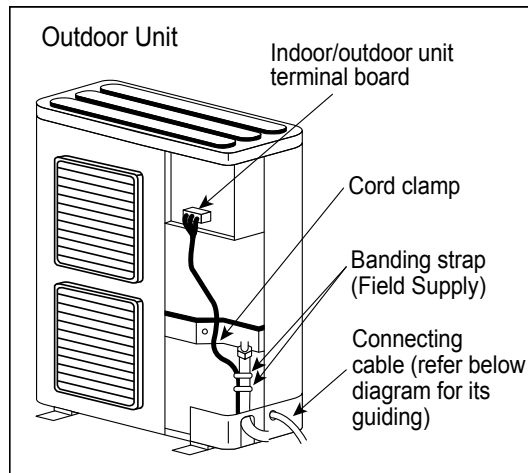

#### 11.4.4.1 Wire Stripping and Connecting Requirement

- Same as indoor requirement. For details please refer the diagram on AIR-TO-WATER HEATPUMP INDOOR UNIT, section 11.3.4 (CONNECT THE CABLE TO THE INDOOR UNIT).

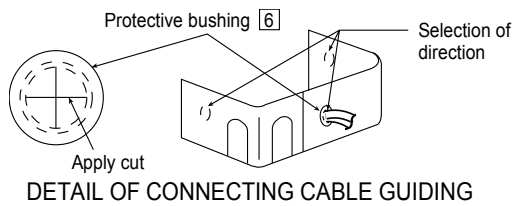

#### 11.4.4.2 Caution

- For three phase model never operate the unit by pressing the electromagnetic switch.
- Never correct the phase by switching over any of the wires inside the unit.

### 11.4.5 Pipe Insulation

- 1 Please carry out insulation at pipe connection portion as mentioned in Indoor/Outdoor Unit Installation Diagram. Please wrap the insulated piping end to prevent water from going inside the piping.
- 2 If drain hose or connecting piping is in the room (where dew may form), please increase the insulation by using POLY-E FOAM with thickness 6 mm or above.

### 11.4.6 DISPOSAL OF OUTDOOR UNIT DRAIN WATER

- When a Drain elbow ② is used, please ensure to follow below:
  - the unit should be placed on a stand which is taller than 50 mm.
  - cover the 8 holes (ø20 mm) with Rubber cap ⑤ (refer to illustration below).
  - use a tray (field supply) when necessary to dispose the outdoor unit drain water.

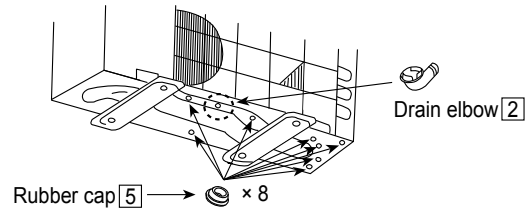

- If the unit is used in an area where temperature falls below 0°C for 2 or 3 consecutive days, it is recommended not to use the Drain elbow ② and Rubber cap ⑤, for the drain water freezes and the fan will not rotate.

# 12. Installation Instruction

(WH-SDC14/16F9E8 WH-UD14/16FE8 only)

## 12.1 Select the Best Location

### INDOOR UNIT

- There should not be any heat source or steam near the unit.
- A place where air circulation in the room is good.
- A place where drainage can be easily done.
- A place where noise prevention is taken into consideration.
- Do not install the unit near the door way.
- Ensure the spaces indicated by arrows from the wall, ceiling, fence or other obstacles.
- Recommended installation height for indoor unit shall be at least 800 mm.
- Must install on a vertical wall.
- When install electrical equipment at wooden building of metal lath or wire lath, according to electrical facility technical standard, no electrical contact between equipment and building is allowed. Insulator must be installed in between.
- Do not install the unit at outdoor. This is designed for indoor installation only.
- When connecting solar pump station cable between indoor unit and solar pump station, the distance between both apparatuses shall be 2 ~ 8 meters and the maximum length of 10 meter only. Failure to do so may lead to abnormal operation to the system.

### OUTDOOR UNIT

- If an awning is built over the unit to prevent direct sunlight or rain, be careful that heat radiation from the condenser is not obstructed.
- Avoid installations in areas where the ambient temperature may drop below -20°C.
- Keep the spaces indicated by arrows from wall, ceiling, fence or other obstacles.
- Do not place any obstacles which may cause a short circuit of the discharged air.
- If outdoor unit installed near sea, region with high content of sulphur or oily location (e.g. machinery oil, etc), it lifespan maybe shorten.
- When installing the product in a place where it will be affected by typhoon or strong wind such as wind blowing between buildings, including the rooftop of a building and a place where there is no building in surroundings, fix the product with an overturn prevention wire, etc. (Overturn prevention fitting model number: K-KYZP15C)

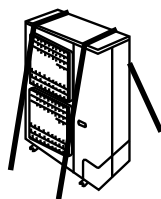

- If piping length is over 10 m, additional refrigerant should be added as shown in the table.

Model	Piping size		Standard Length (m)	Max. Elevation (m)	Min. Piping Length (m)	Max. Piping Length (m)	Additional Refrigerant (g/m)
	Gas	Liquid					
WH-SDC14/16F9E8 WH-UD14/16FE8	ø15.88mm (5/8")	ø9.52mm (3/8")	5-7.5	20	3	30	50

Example :

If piping length is 30 m, the quantity of additional refrigerant should be 1000 g. [(30-10)m × 50 g/m = 1000 g]

## 12.2 Indoor/Outdoor Unit Installation Diagram

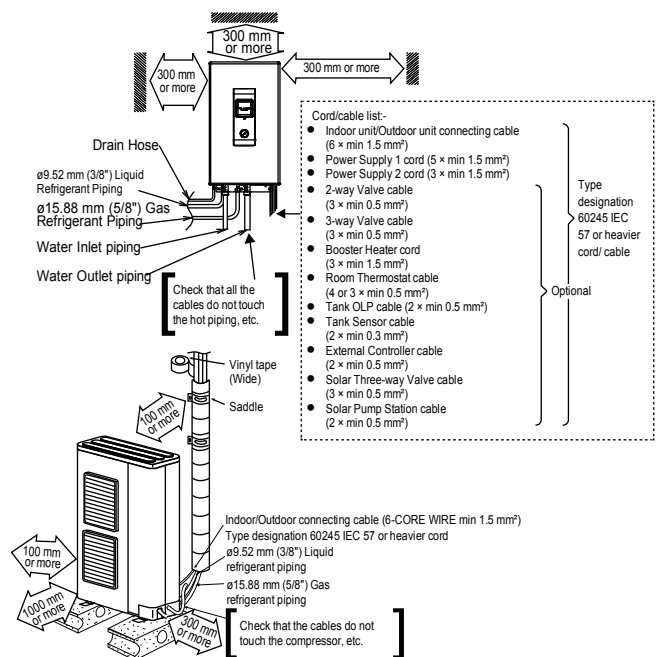

It is advisable to avoid more than 2 blockage directions. For better ventilation & multiple-outdoor installation, please consult authorized dealer/specialist.

- This illustration is for explanation purposes only. The indoor unit will actually face a different way.

## 12.3 Indoor Unit

### 12.3.1 How to Fix Installation Plate

The mounting wall is strong and solid enough to prevent it from vibration.

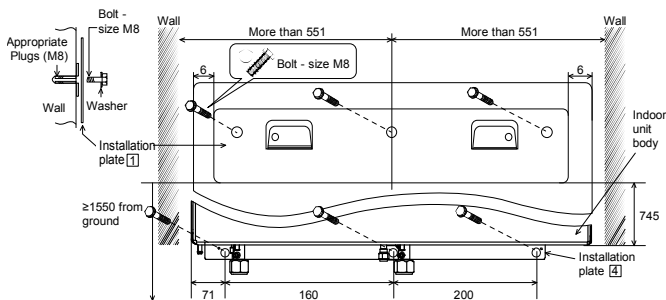

The centre of installation plate should be at more than 551 mm at right and left of the wall.

The distance from installation plate edge to ground should more than 1550 mm.

- Always mount the installation plate horizontally by aligning the marking thread and using a level gauge.
- Mount the installation plate on the wall with 6 sets of plug, bolt and washer (all non-supply) with size M8.

### 12.3.2 To Drill a Hole in the Wall and Install a Sleeve of Piping

- 1 Insert the piping sleeve to the hole.
- 2 Fix the bushing to the sleeve.
- 3 Cut the sleeve until it extrudes about 15 mm from the wall.

#### CAUTION

When the wall is hollow, please be sure to use the sleeve for tube assembly to prevent dangers caused by mice biting the connecting cable.

- 4 Finish by sealing the sleeve with putty or caulking compound at the final stage.

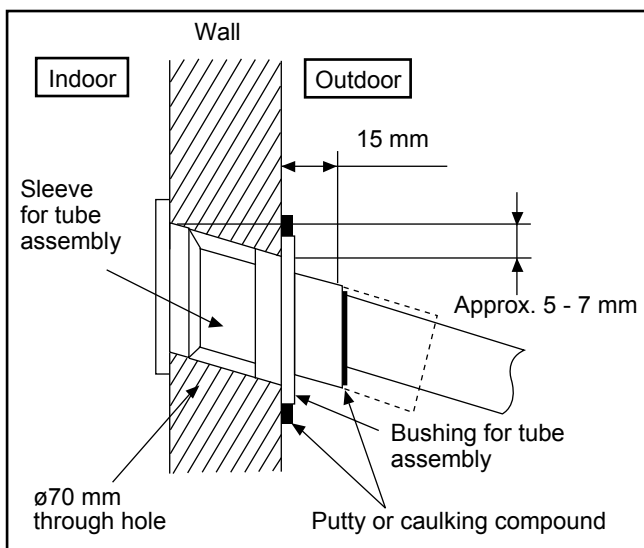

### 12.3.3 Indoor Unit Installation

#### 12.3.3.1 Install the Indoor Unit

- 1 When connecting solar pump station cable between indoor unit and solar pump station, the distance between both apparatuses shall be 2 ~ 8 meters and the maximum length of 10 meter only. Failure to do so may lead to abnormal operation to the system.
- 2 Engage the slots on the indoor unit to the hooks of installation plate 1. Ensure the hooks are properly seated on the installation plate by moving it left and right.
- 3 Fix the screws 3 to the holes on the hooks of installation plate, 4, as illustrated below.

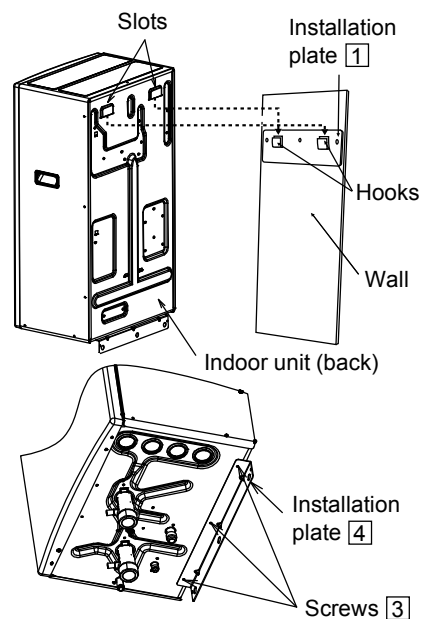

#### 12.3.3.2 Water Piping Installation

- The minimum requirement of water in the system is 50 litres. If this value could not be achieved, please install additional buffer tank (field supply).
- Water inlet and water outlet in indoor unit are used for connection to water circuit. Please request a licensed technician to install this water circuit.
- This water circuit must comply with all relevant European and national regulations, i.e. IEC/EN 61770.
- Be careful not to deform the piping with excessive force when doing piping connection job.
- Use Rp 1 1/4" nut for both water inlet and outlet connection and clean all pipings with tap water before connecting to the indoor unit.
- Cover the pipe end to prevent dirt and dust when inserting it through a wall.
- Choose proper sealer which can withstand the pressures and temperatures of the system.
- If an existing tank is to be connected to this indoor/outdoor unit, ensure the pipes are clean before water pipe installation is carried out.



- An external filter (30 mesh or more, field supplied) must be installed before the water inlet of the indoor unit (with "WATER IN" indication).
- Refer to Diagram 4.1 for pipe connection of Radiator, Floor Heater, Tank Unit, Solar Pump Station, 3-way Valve Kit, 2-way Valve Kit and etc. Fail to connect the pipes appropriately might cause the unit malfunction.

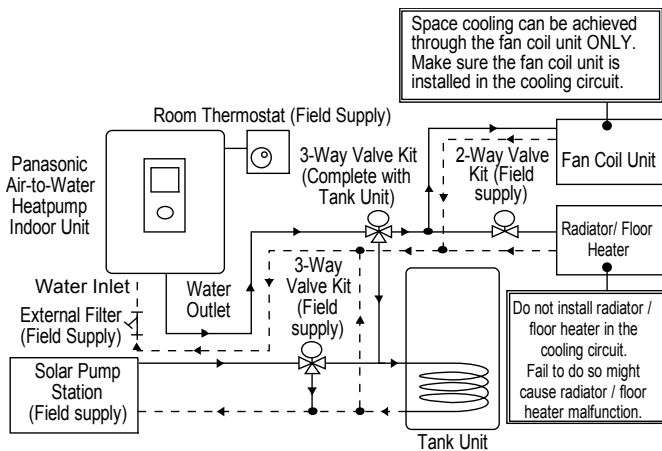
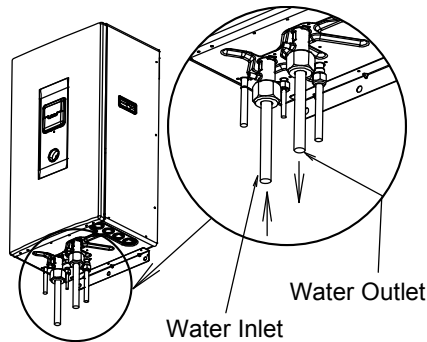

Diagram 4.1: Typical Water Piping Installation

- Be sure to use two spanners to tighten the connection. Tighten the nuts with torque wrench: 117.6 N•m.
- If non-brass metallic piping is used for installation, make sure to insulate the pipes to prevent galvanic corrosion.
- Make sure to insulate the water circuit pipes to prevent reduction of heating capacity.
- After installation, check the water leakage condition in connection area during test run.



**CAUTION**  
Do not over tighten, over tightening cause water leakage.

### 12.3.3.3 Insulation

- Mount the PS foam [7] and long banding strap [8] to water inlet and outlet connectors, as shown in below illustration.

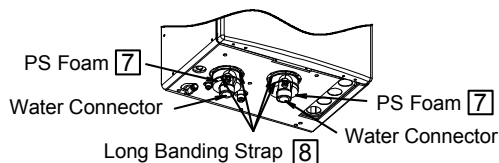

### 12.3.3.4 Indoor Unit Refrigerant Pipe Installation

- 1 Please make flare after inserting flare nut (located at joint portion of tube assembly) onto the copper pipe. (In case of using long piping)
- 2 Do not use pipe wrench to open refrigerant piping. Flare nut may be broken and cause leakage. Use proper spanner or ring wrench.
- 3 Connect the piping:
  - Align the center of piping and sufficiently tighten the flare nut with fingers.
  - Further tighten the flare nut with torque wrench in specified torque as stated in the table.

Model	Piping size (Torque)	
	Gas	Liquid
WH-SDC14/16F9E8	ø15.88 mm (5/8")	ø9.52 mm (3/8")
WH-UD14/16FE8	[65 N•m]	[42 N•m]

**CAUTION**  
Do not over tighten, over tightening cause gas leakage.

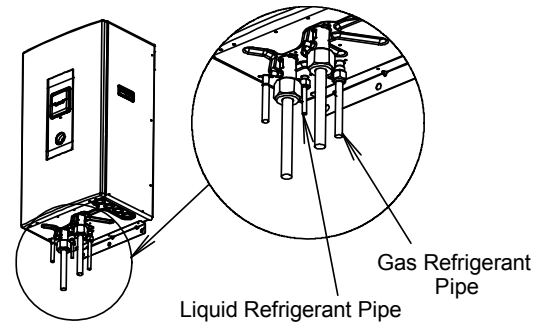

### 12.3.3.5 Drain Hose Installation

- Use inner diameter 15 mm drain hose in the market.
- This hose must to be installed in a continuously downward direction and in a frost-free environment.
- Do not insert this hose into sewage or drain pipe that may generate ammonia gas, sulfuric gas, etc.
- If necessary, use hose clamp to further tighten the hose at drain hose connector to prevent leakage.
- Water will drip from this hose, therefore the outlet of this hose must be installed in an area where the outlet cannot become blocked.

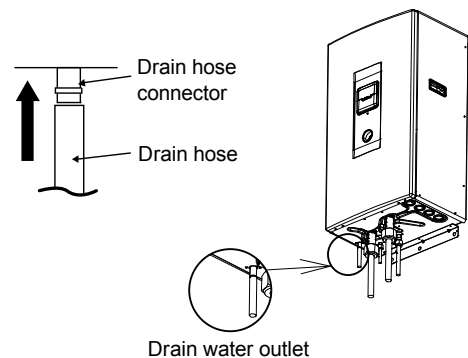

### 12.3.3.6 Drain Elbow and Hose Installation

- Fix the drain elbow ⑩ and packing ⑨ to the bottom of indoor unit, as shown in below illustration.
- Use inner diameter 17 mm drain hose in the market.
- This hose must be installed in a continuously downward direction and in a frost-free environment.
- Guides this hose's outlet to outdoor only.
- Do not insert this hose into sewage or drain pipe that may generate ammonia gas, sulfuric gas, etc.
- If necessary, use hose clamp to further tighten the hose at drain hose connector to prevent leakage.

- Water will drip from this hose, therefore the outlet of this hose must be installed in an area where the outlet cannot become blocked.

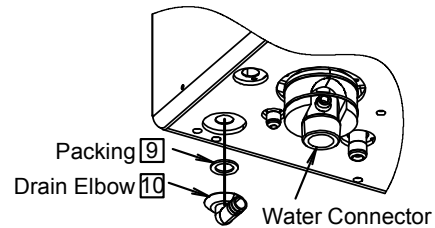

### 12.3.4 Connect the Cable to the Indoor Unit

- 1 Connecting cable between indoor unit and outdoor unit shall be approved polychloroprene sheathed  $6 \times \text{min } 1.5 \text{ mm}^2$  flexible cord, type designation 60245 IEC 57 or heavier cord.
  - Ensure the colour of wires of outdoor unit and the terminal no. are the same to the indoor unit's respectively.
  - Earth wire shall be longer than the other wires as shown in the figure for the electrical safety in case of the slipping out of the cord from the Holder (Clamper).
- 2 An isolating device must be connected to the power supply cable.
  - Isolating device (Disconnecting means) should have minimum 3.0 mm contact gap.
  - Connect the approved polychloroprene sheathed as below, type designation 60245 IEC 57 or heavier cord to the terminal board, and to the other end of the cord to isolating device (Disconnecting means).
    - Power supply 1 cord ( $5 \times \text{min } 1.5 \text{ mm}^2$ )
    - Power supply 2 cord ( $5 \times \text{min } 1.5 \text{ mm}^2$ )
- 3 To avoid the cable and cord being damaged by sharp edges, the cable and cord must be passed through a bushing (located at the bottom of indoor unit) before being connected to the terminal block. The bushing must be used and must not be removed.

#### For model WH-SDC14/16F9E8

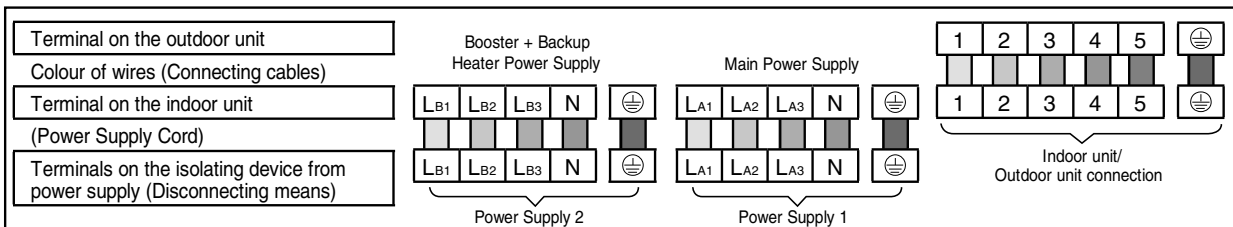

#### Connecting with external device (optional)

- 1 **All connections shall** follow to the local national wiring standard.
- 2 It is strongly recommended to use manufacturer-recommended parts and accessories for installation.
- 3 Maximum output power of booster heater shall be  $\leq 3 \text{ kW}$ . Booster Heater cord must be ( $3 \times \text{min } 1.5 \text{ mm}^2$ ), of type designation 60245 IEC 57 or heavier.
- 4 Two-way Valve shall be spring and electronic type, refer to "Field Supply Accessories" table for details. Valve cable shall be ( $3 \times \text{min } 0.5 \text{ mm}^2$ ), of type designation 60245 IEC 57 or heavier, or similarly double insulation sheathed cable.
  - \* note: - Two-way Valve shall be CE marking compliance component.
  - Maximum load for the valve is 9.8 VA.
- 5 Three-Way Valve shall be spring and electronic type. Valve's cable shall be ( $3 \times \text{min } 0.5 \text{ mm}^2$ ), of type designation 60245 IEC 57 or heavier, or similarly double insulation sheathed cable.
  - \* note: - Shall be CE marking compliance component.
  - It shall be directed to heating mode when it is OFF.
  - Maximum load for the valve is 9.8 VA.
- 6 Room Thermostat cable must be ( $4 \text{ or } 3 \times \text{min } 0.5 \text{ mm}^2$ ), double insulation layer of PVC-sheathed or rubber-sheathed cable.

- 7 Tank OLP cable must be (2 × min 0.5 mm<sup>2</sup>), double insulation layer of PVC-sheathed or rubber-sheathed cable.  
\* note: - if such connection deemed NO necessary for tank OLP, please connect jumper between terminal no. 13 and 14.
- 8 Tank Sensor shall be resistance type, please refer to Graph 5.1 for the characteristic and details of sensor. Its cable shall be (2 × min 0.3 mm<sup>2</sup>), double insulation layer (with insulation strength of min 30 V) of PVC-sheathed or rubber-sheathed cable.
- 9 External Controller shall be connected to 1-pole switch with min 3.0mm contact gap. (connection refer to Diagram 5.2). Its cable must be (2 × min 0.5 mm<sup>2</sup>), double insulation layer of PVC-sheathed or rubber-sheathed cable.  
\* note: - When making such connection, kindly remove the jumper between terminal no. 17 and 18.  
- Switch used shall be CE compliance component.  
- Maximum operating current shall be less than 3A<sub>rms</sub>.
- 10 Must install Solar Connection PCB (11) (optional) to indoor unit when Solar Pump Station is utilized. Refer Solar Connection PCB's installation instruction for detail of installation.
- 11 Solar Three-way Valve cable shall be (3 × min 0.5 mm<sup>2</sup>), double insulation layer PVC-sheathed or rubber-sheathed cable.
- 12 Solar Pump Station cable shall be (2 × min 0.5 mm<sup>2</sup>), of double insulation PVC-sheathed or rubber-sheathed cable. Strongly recommended install with maximum length of 10 meter only.

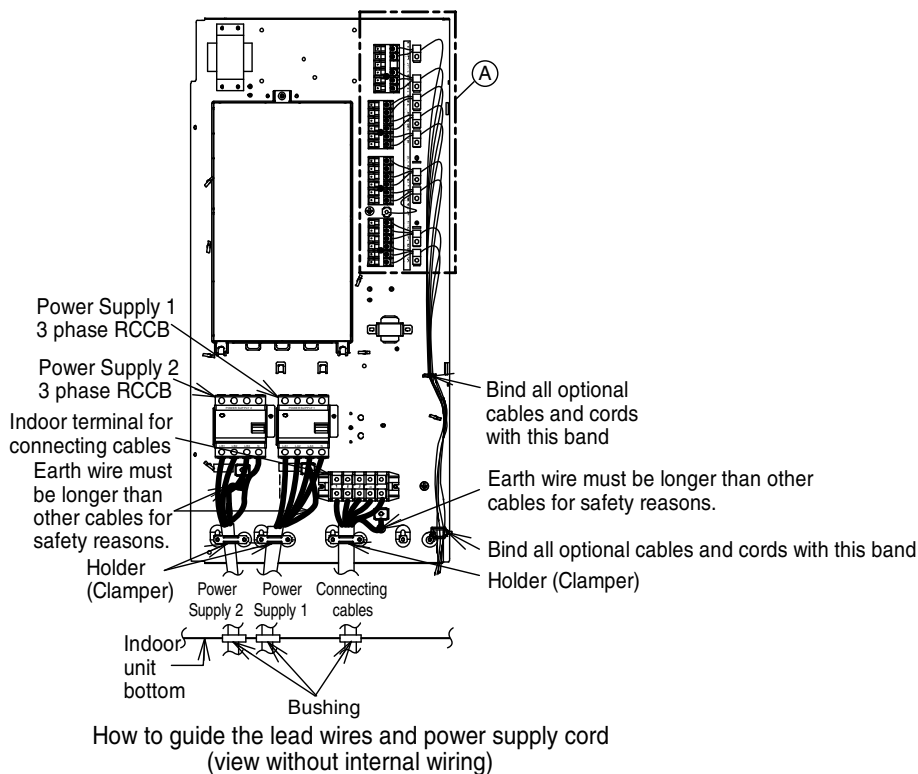
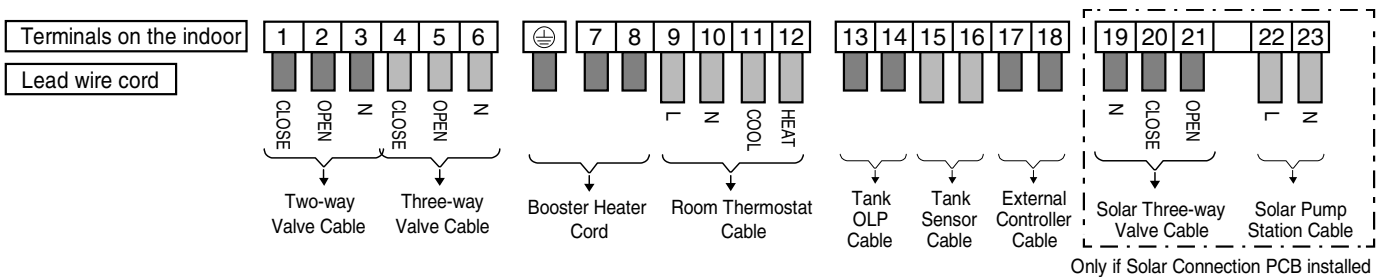

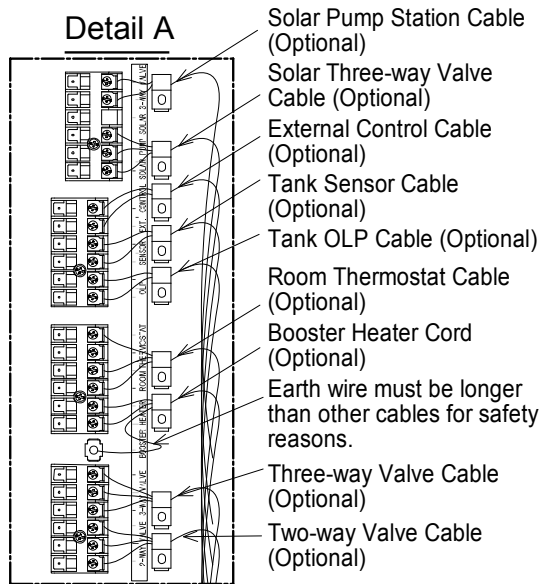

### 12.3.4.1 Wire Stripping and Connecting Requirement

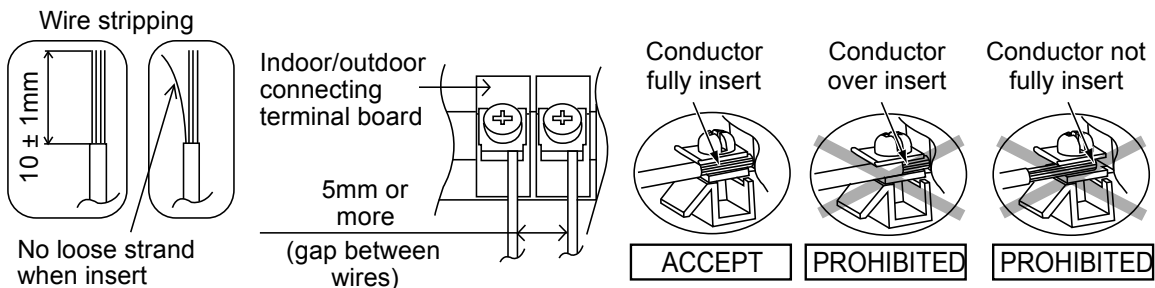

Graph 5.1: Tank sensor characteristic

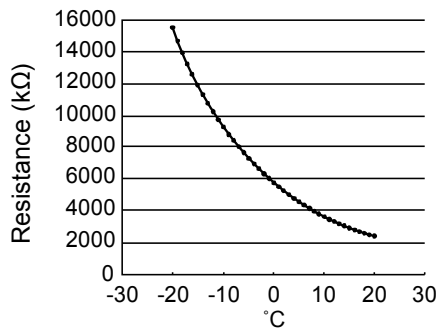

Graph 5.1: Tank sensor characteristic

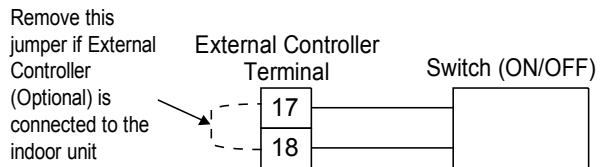

Diagram 5.2: External Controller connecting diagram

### 12.3.4.2 Connecting Requirement

#### For model WH-SDC14/16F9E8

- The equipment's power supply 1 complies with IEC/EN 61000-3-2.
- The equipment's power supply 2 complies with IEC/EN 61000-3-2.
- The equipment's power supply 2 shall be connected to a suitable supply network, with the following maximum permissible system impedance  $Z_{max}$  at the interface of the point: 0.449 Ω. Please liaise with supply authority to ensure that power supply 2 is connected to a supply of the impedance or less.

## 12.4 Outdoor Unit

### 12.4.1 Install the Outdoor Unit

- After selecting the best location, start installation according to Indoor/Outdoor Unit Installation Diagram.
  - Fix the unit on concrete or rigid frame firmly and horizontally by bolt nut ( $\varnothing 10$  mm).
  - When installing at roof, please consider strong wind and earthquake. Please fasten the installation stand firmly with bolt or nails.

(Unit in mm)

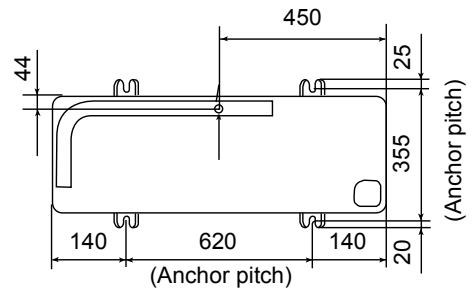

### 12.4.2 CONNECTING THE PIPING

Model	Piping size (Torque)	
	Gas	Liquid
WH-SDC14/16F9E8 WH-UD14/16FE8	$\varnothing 15.88$ mm (5/8") [65 N•m]	$\varnothing 9.52$ mm (3/8") [42 N•m]

Do not over tighten, over tightening cause gas leakage.

#### Connecting The Piping To Outdoor Unit

Decide piping length and then cut by using pipe cutter. Remove burrs from cut edge. Make flare after inserting the flare nut (locate at valve) onto the copper pipe.

Align center of piping to valves and then tighten with torque wrench to the specified torque as stated in the table.

Local pipes can project in any of four directions.

- Make holes in the pipe panels for the pipes to pass through.
- Be sure to install the pipe panels to prevent rain from getting inside the outdoor unit.  
[Removing the service panel].

- Remove the three mounting screws.
- Slide the service panel downward to release the pawls.

After this, pull the service panel toward you to remove it.

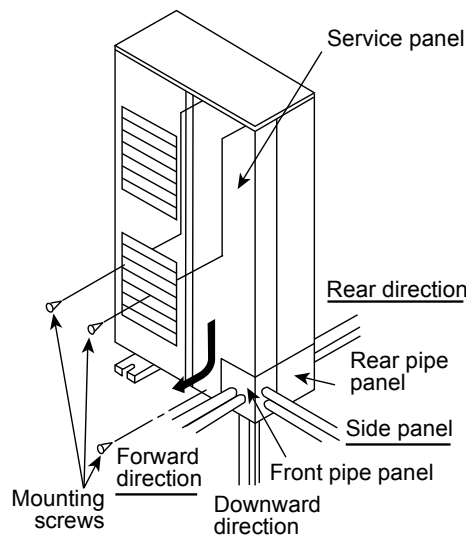

**CAUTION**

Be sure to use two spanners to tighten.  
(If the nuts are over tightened, it may cause the flares to break or leak.)

Do not attach the spanners here

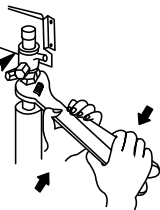

Close the tube joining area with putty heat insulator (local supply) without any gap as shown in right figure. (To prevent insects or small animal entering.)

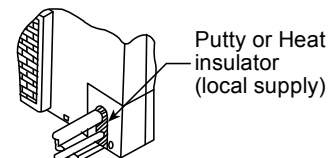

## CUTTING AND FLARING THE PIPING

- 1 Please cut using pipe cutter and then remove the burrs.
- 2 Remove the burrs by using reamer. If burrs is not removed, gas leakage may be caused. Turn the piping end down to avoid the metal powder entering the pipe.
- 3 Please make flare after inserting the flare nut onto the copper pipes.

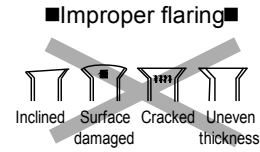
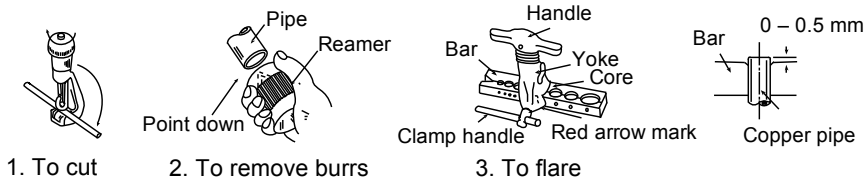

When properly flared, the internal surface of the flare will evenly shine and be of even thickness. Since the flare part comes into contact with the connections, carefully check the flare finish.

## 12.4.3 Evacuation of the Equipment

WHEN INSTALLING AN AIR-TO-WATER HEAT PUMP, BE SURE TO EVACUATE THE AIR INSIDE THE INDOOR UNIT AND PIPES in the following procedure.

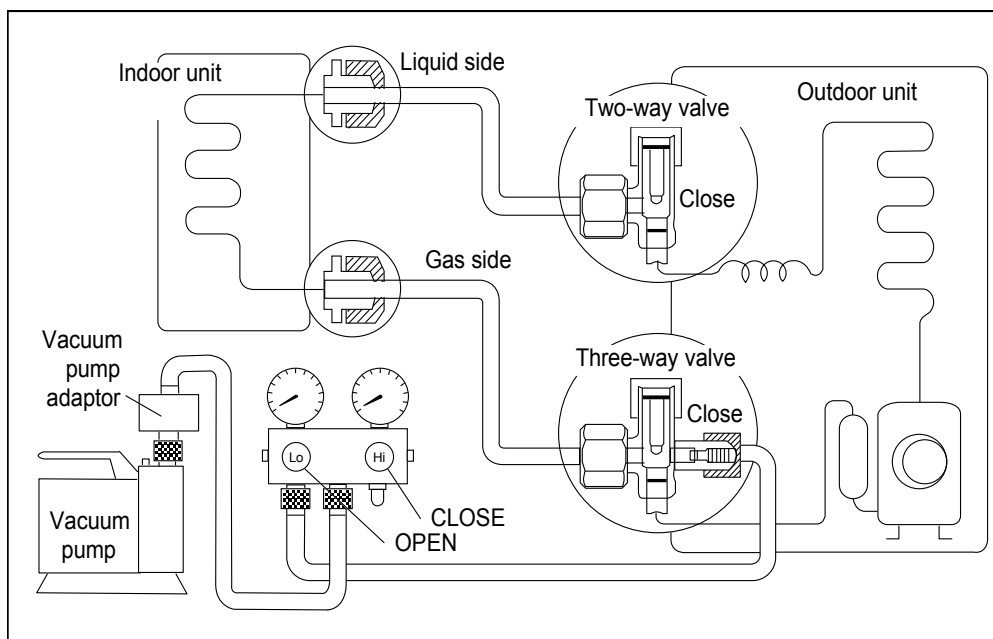

- 1 Connect a charging hose with a push pin to the Low side of a charging set and the service port of the 3-way valve.
  - o Be sure to connect the end of the charging hose with the push pin to the service port.
- 2 Connect the center hose of the charging set to a vacuum pump with check valve, or vacuum pump and vacuum pump adaptor.
- 3 Turn on the power switch of the vacuum pump and make sure that the needle in the gauge moves from 0 cmHg (0 MPa) to -76 cmHg (-0.1 MPa). Then evacuate the air approximately ten minutes.
- 4 Close the Low side valve of the charging set and turn off the vacuum pump. Make sure that the needle in the gauge does not move after approximately five minutes.
 

Note: BE SURE TO FOLLOW THIS PROCEDURE IN ORDER TO AVOID REFRIGERANT GAS LEAKAGE.
- 5 Disconnect the charging hose from the vacuum pump and from the service port of the 3-way valve.
- 6 Tighten the service port caps of the 3-way valve at a torque of 18 N·m with a torque wrench.
- 7 Remove the valve caps of both of the 2-way valve and 3-way valve. Position both of the valves to "OPEN" using a hexagonal wrench (4 mm).
- 8 Mount valve caps onto the 2-way valve and the 3-way valve.
  - o • Be sure to check for gas leakage.

### ⚠ CAUTION

If gauge needle does not move from 0 cmHg (0 MPa) to -76 cmHg (-0.1 MPa), in step ③ above take the following measure:

- If the leak stops when the piping connections are tightened further, continue working from step ③.
- If the leak does not stop when the connections are retightened, repair the location of leak.
- Do not release refrigerant during piping work for installation and reinstallation. Take care of the liquid refrigerant, it may cause frostbite.

### 12.4.4 Connect the Cable to the Outdoor Unit

(FOR DETAIL REFER TO WIRING DIAGRAM AT UNIT)

- 1 Remove the control board cover from the unit by loosening the screw.
- 2 Connecting cable between indoor unit and outdoor unit shall be approved polychloroprene sheathed (6 × min 1.5 mm<sup>2</sup>) flexible cord, type designation 60245 IEC 57 or heavier cord.

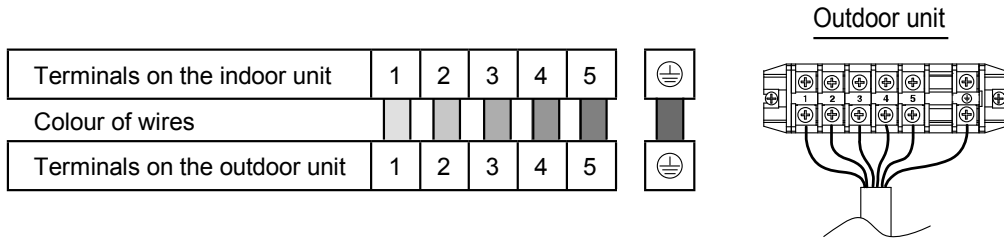

- 3 Secure the cable onto the control board with the holder (clammer).
- 4 Select required direction and apply protective bushing provided in accessories to protect cables from sharp edges.
- 5 Once all wiring work has been completed, tie the cables and cord together with the binding strap so that they do not touch other parts such as the compressor and bare copper pipes.
- 6 Install back the control board cover.

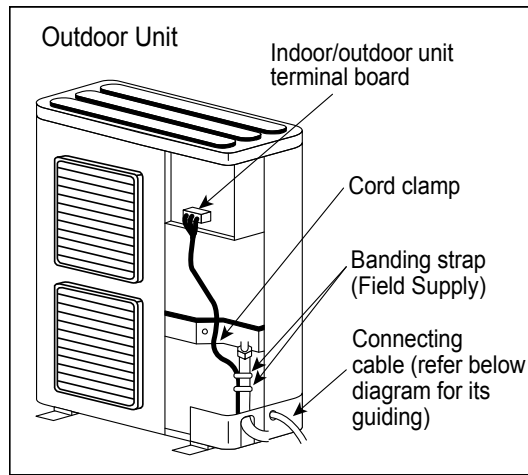

#### 12.4.4.1 Wire Stripping and Connecting Requirement

- Same as indoor requirement. For details please refer the diagram on AIR-TO-WATER HEATPUMP INDOOR UNIT, section 11.3.4 (CONNECT THE CABLE TO THE INDOOR UNIT).

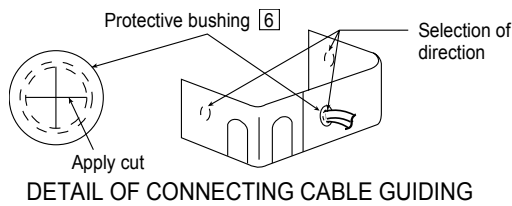

#### 12.4.4.2 Caution

- For three phase model never operate the unit by pressing the electromagnetic switch.
- Never correct the phase by switching over any of the wires inside the unit.

### 12.4.5 Pipe Insulation

- 1 Please carry out insulation at pipe connection portion as mentioned in Indoor/Outdoor Unit Installation Diagram. Please wrap the insulated piping end to prevent water from going inside the piping.
- 2 If drain hose or connecting piping is in the room (where dew may form), please increase the insulation by using POLY-E FOAM with thickness 6 mm or above.

## 12.4.6 DISPOSAL OF OUTDOOR UNIT DRAIN WATER

- When a Drain elbow ② is used, please ensure to follow below:
  - the unit should be placed on a stand which is taller than 50 mm.
  - cover the 8 holes (ø20 mm) with Rubber cap ⑤ (refer to illustration below).
  - use a tray (field supply) when necessary to dispose the outdoor unit drain water.

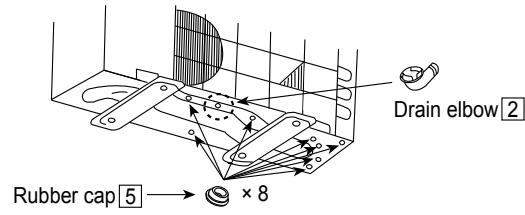

- If the unit is used in an area where temperature falls below 0°C for 2 or 3 consecutive days, it is recommended not to use the Drain elbow ② and Rubber cap ⑤, for the drain water freezes and the fan will not rotate.



## 13. Operation and Control

### 13.1 Basic Function

Inverter control, which equipped with a microcomputer in determining the most suitable operating mode as time passes, automatically adjusts output power for maximum comfort always. In order to achieve the suitable operating mode, the microcomputer maintains the set temperature by measuring the temperature of the environment and performing temperature shifting. The compressor at outdoor unit is operating following the frequency instructed by the microcomputer at indoor unit that judging the condition according to internal water setting temperature and water outlet temperature.

#### 13.1.1 Internal Water Setting Temperature

Once the operation starts, control panel setting temperature will be taken as base value for temperature shifting processes. These shifting processes are depending on the Air-to-Water Heat pump settings and the operation environment. The final shifted value will be used as internal water setting temperature and it is updated continuously whenever the electrical power is supplied to the unit.

#### 13.1.2 Heating Operation

##### 13.1.2.1 Thermostat Control

- Compressor is OFF when Water Outlet Temperature – Internal Water Setting Temperature  $> 2^{\circ}\text{C}$  for continuously 3 minutes.
- Compressor is ON after waiting for 3 minutes, if the Water Outlet Temperature – Water Inlet Temperature (temperature at thermostat OFF is triggered)  $< -3^{\circ}\text{C}$ .

##### 13.1.2.2 Thermostat Control (Outdoor Ambient Temperature)

Stops provide heating to room side during high outdoor ambient condition.

Control content:

- Heating operation and water pump will turn OFF when outdoor ambient temperature  $>$  outdoor thermo off temperature  $+ 3^{\circ}\text{C}$ .  
(Outdoor thermo off set temperature is set by control panel. Thermo off set temperature is between  $5^{\circ}\text{C} \sim 35^{\circ}\text{C}$ )
- Heating operation will resume when Outdoor ambient temperature  $<$  Outdoor thermo OFF set temperature  $+ 1^{\circ}\text{C}$ .

##### 13.1.2.3 Heat Mode Operation

Operation of heat pump provide heating capacity to room side by hot water through heating panel, floor heating or fan coil unit.

- 1 3 ways valve control:
  - 3 ways valve switch and fix to heating side.
- 2 Heat pump operates follow normal heating operation.
- 3 Back up heater operate follow normal operation.
- 4 Solar 3 way valve operates follow solar operation specification.
- 5 2 ways valve control:
  - 2 ways valve opens.

# Heat Mode Operation Time Chart

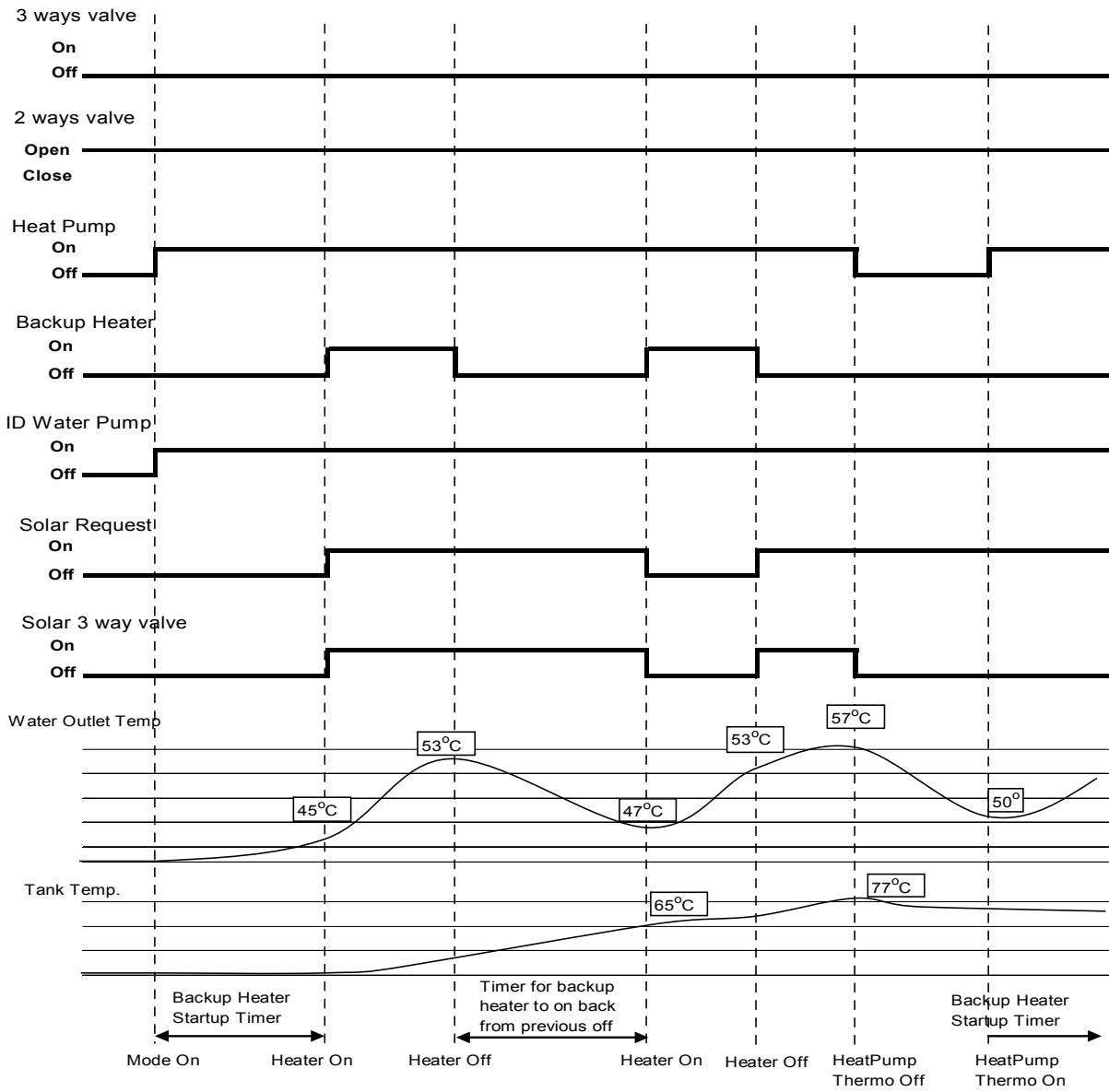

### 13.1.3 Cooling Operation

#### 13.1.3.1 Thermostat control

- Compressor is OFF when Water Outlet Temperature – Internal Water Setting Temperature > -1.5°C for continuously 3 minutes.
- Compressor is ON after waiting for 3 minutes, if the Water Outlet Temperature – Water Inlet Temperature (temperature at thermostat OFF is triggered) >3°C.

#### 13.1.3.2 Cool Mode Operation

- 1 3 ways valve control:
  - 3 ways valve switch and fix to cooling side.
- 2 Heat pump operates follow normal cooling operation.
- 3 Backup heater DOES NOT operate during cool mode.
- 4 Solar 3 way valve operates follow solar operation specification.
- 5 2 ways valve control:
  - 2 ways valve is closed.

Cool Mode Operation Time Chart

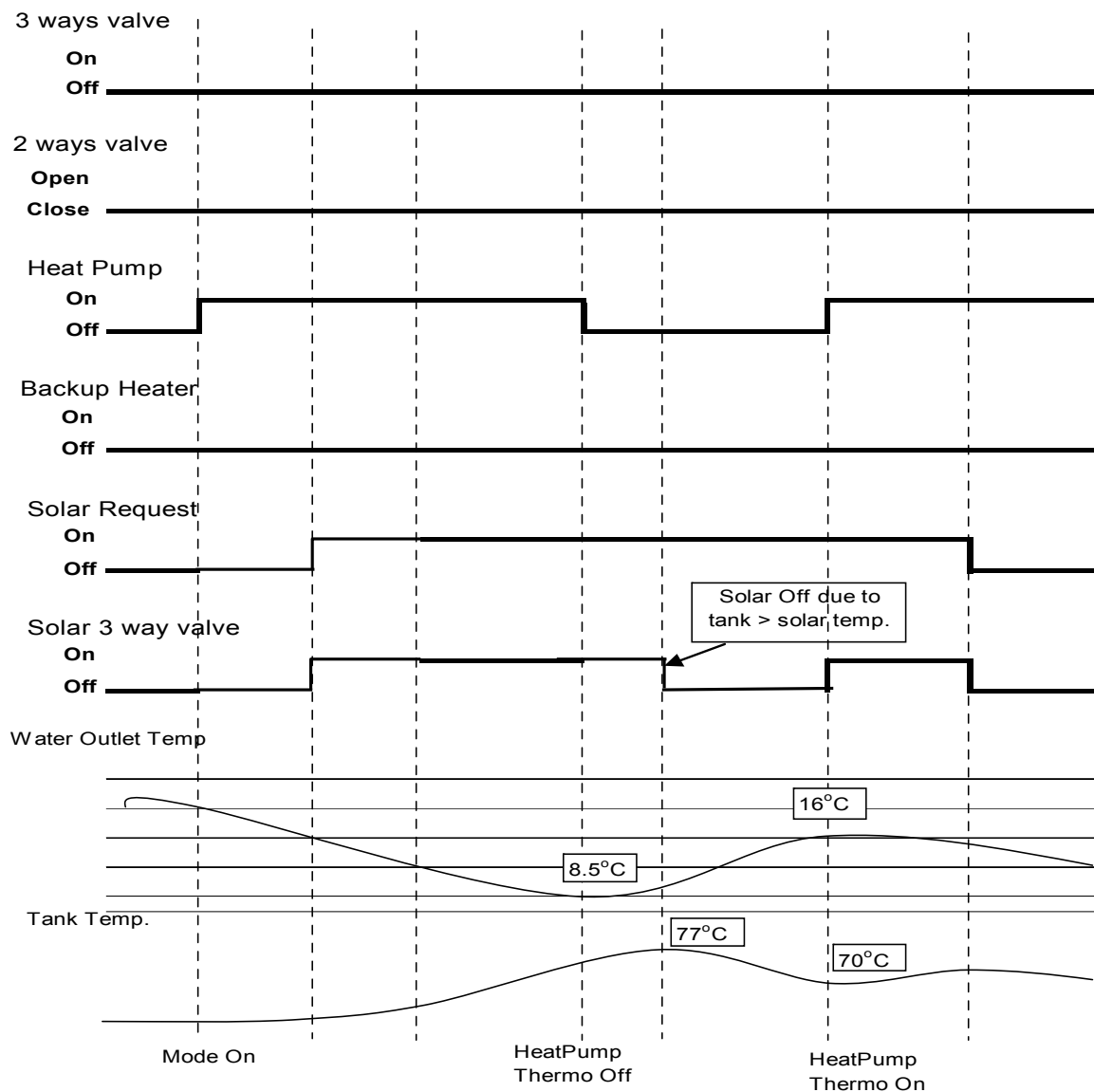

### 13.1.4 Auto Mode Operation

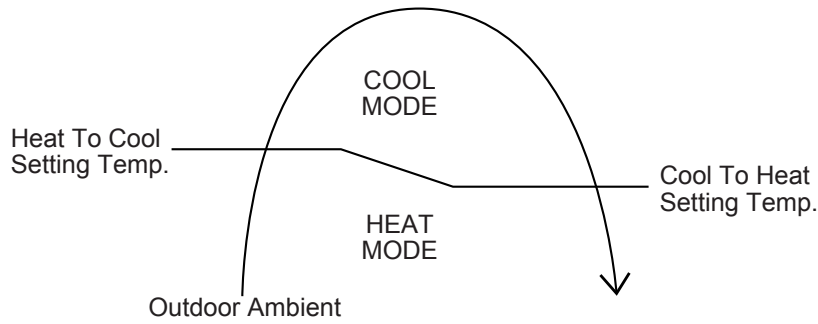

- Control details:
  - To enable the unit to operate either heat or cool mode automatically, heat to cool set temperature and cool to heat set temperature can be set by control panel.
  - Automatic operation is judged based on control panel setting temperature and outdoor ambient temperature.
  - \* Minimum setting of heat to cool set temperature is 1°C higher than cool to heat set temperature.
- Judgement control:
  - If outdoor ambient temperature < Heat to Cool Set Temperature, unit will operate in Heat Mode or else the unit will operate in Cool Mode.
  - If current operation is Cool mode, outdoor ambient temperature > Cool to Heat Temperature, unit will maintain Cool mode operation or else the unit will operate Heat mode.
  - If current operation is Heat mode, outdoor ambient temperature > Heat to Cool Temperature, unit will maintain Heat mode operation or else the unit will operate Cool mode.
  - Every 60 minutes the outdoor ambient temperature is judged.
  - When Auto + Tank mode is selected, operation mode switching is judged by both outdoor ambient temperature and indoor air temperature.

### 13.1.5 Auto Cooling Mode Operation Limit

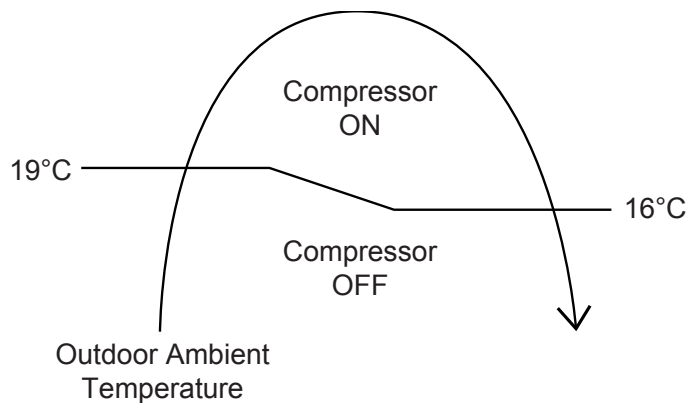

- Auto Mode Cooling Only operation will start once the outdoor ambient temperature reaches 19°C and compressor will continue to run until the outdoor ambient temperature drops to 16°C.
- Due to this limitation, If Heat to Cool temperature is set lower than 19°C, the compressor will not operate until the outdoor ambient temperature reaches 19°C or higher.

### 13.1.6 Tank Mode Operation

#### Control contents:

- 3 ways valve direction
  - 3 ways valve switch to tank side during Tank Thermo ON condition. Switch 3 ways valve to room side when tank achieve Tank Thermo OFF temperature and SOLAR turn ON condition.
  
- Heat Pump Thermostat characteristic
  - Water set temperature = Tank set temperature or [50°C] whichever lower.
  - Heat pump Water Outlet set temperature is set to [53°C] at tank mode.
  
- Tank Thermo ON/OFF characteristic
  - THERMO OFF TEMP:
    1. THERMO OFF TEMP = Tank water set temperature + [0°C].
    2. Tank temperature > THERMO OFF TEMP for continuous 10 seconds after heat pump OFF, water pump OFF or
    3. Tank temperature > Tank set temperature + [2°C] for continuously 20 seconds.
  
  - THERMO ON TEMP:
    1. THERMO ON TEMP = Tank water set temperature + [-2°C].When detect tank temperature < THERMO ON TEMP, water pump ON for 3 minutes then heat pump ON.

#### Characteristic of heat pump thermo ON/OFF under Tank Mode condition:

- Water Outlet Thermo Condition
  - Heat pump THERMO OFF TEMP:
    1. Heat pump THERMO OFF TEMP = 53°C + [+4°C].
    2. Water outlet temperature > Heat pump THERMO OFF TEMP for continuous 3 minutes, heat pump OFF.
  
  - Heat pump THERMO ON TEMP:
    1. Heat pump THERMO ON TEMP = Water inlet during thermo OFF time + [-3°C].
    2. Heat pump ON back when water outlet temperature < Heat pump THERMO ON TEMP.
  
- Water Inlet Thermo Condition
  - Heat pump THERMO OFF TEMP:
    1. Water inlet temperature > 55°C for continuous 60 seconds, heat pump OFF.
  
  - Heat pump THERMO ON TEMP:
    1. Heat pump THERMO ON TEMP = Water inlet temperature < 55°C.
  
- Booster heater control
  - Booster heater turns ON and OFF follow normal operation.
  - Booster heater turns ON condition:
    1. During start up time (initialization), Booster heater turns ON after DELAY TIMER.
    2. When tank temperature lower than HEATER ON TEMP.
    3. 20 minutes from previous heater OFF.
  - Booster heater turns OFF CONDITION:
    1. When tank temperature higher than tank set temperature for continuous 15 seconds.
  
- Solar 3-way valve
  - Solar pump operates follow solar operation specification.
  
- 2 way valve closes
- Other
  - Indoor backup heater cannot be ON during tank mode only.

Tank mode

Tank set Temp.=65C

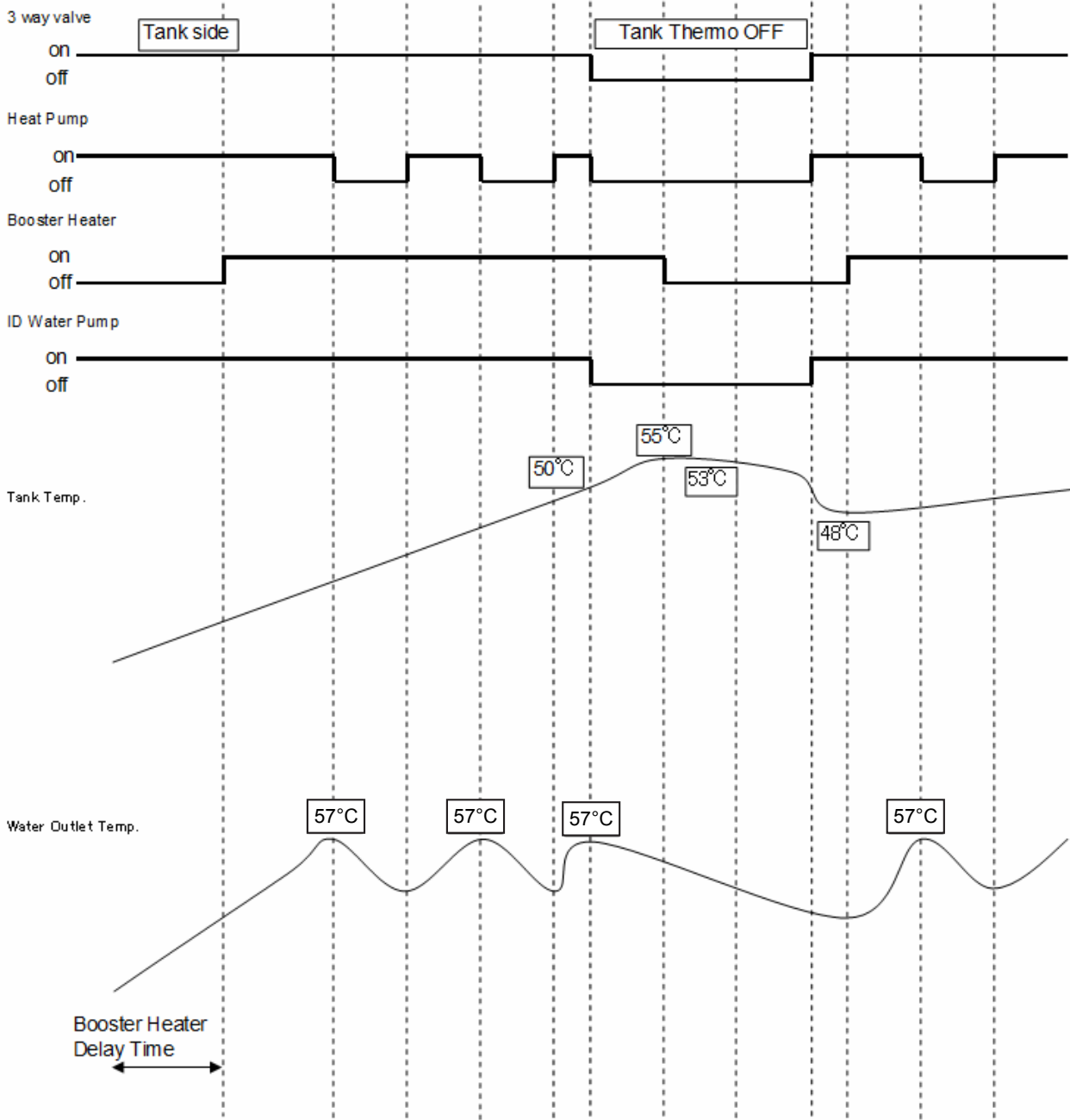

Tank mode ( Solar Priority is not set )

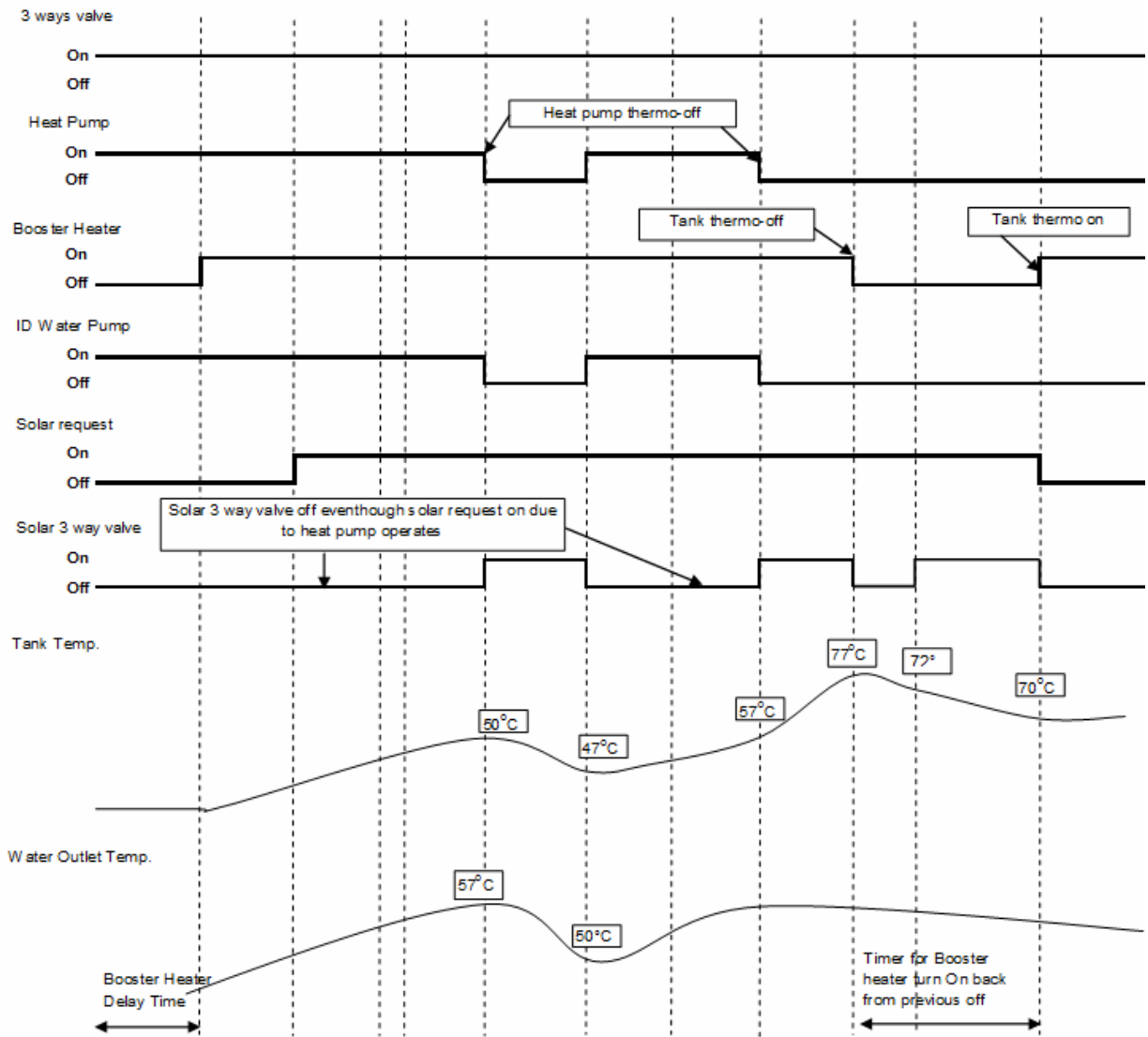

### 13.1.7 Heat + Tank Mode Operation

Setting 1: When Heating priority is set by control panel:

1. 3 ways valve control:
  - 3 ways valve switch to room side during External Room Thermo ON **OR** Solar 3 ways valve ON **OR** Tank Thermo OFF time, and switch to tank side at External Room Thermo OFF **AND** Solar 3 ways valve OFF.
2. Heat pump operation control:-
  - **During External Room Thermo ON time:** (When room thermo ON, heat pump must operate to room side)
    - Heat pump operates follow normal operation at room side.
  - **During External Room Thermo ON time:**
    - Switch 3 ways valve to tank side, IFUnder Solar Priority Set condition:
    - Tank temperature < Tank THERMO ON TEMP **AND** Solar Valve OFFUnder Solar Priority Not Set condition:
    - Tan temperature < Tank THERMO ON TEMP
  - Switch back 3 ways valve to room side, Heat pump and water pump turn OFF, IF
    - External Room Thermo ON back **OR**Under Solar Priority Set condition:
    - Tank temperature > Tank THERMO OFF TEMP for continuous 10 seconds **OR** Solar Valve ON.Under Solar Priority Not Set condition:
    - Tank temperature > Tank THERMO OFF TEMP for continuous 10 seconds.

\* Judge only after heat pump THERMO OFF  
\* THERMO ON and THERMO OFF point refer to case below.

Operation condition when 3 ways valve switch to tank side:

- Tank water set temperature = tank set temperature or [50°C] whichever lower.
- Heat Pump Water Outlet set temperature is set to [53°C] during tank interval.
- Initial Tank THERMO ON TEMP = heat pump tank target temperature + [-2°C].

Tank Thermo ON/OFF Characteristic

- THERMO OFF TEMP:
  1. THERMO OFF TEMP = Heat pump tank target temperature + [0°C].
  2. Tank temperature > THERMO OFF TEMP for continuous 10 seconds after heat pump OFF due to water thermo, switch 3 ways valve to room side **OR**
  3. Tank temperature > Tank set temperature + 2°C for continuous 10 seconds, switch 3 ways valve to room side.
- Next THERMO ON TEMP:
  1. THERMO ON TEMP = Heat pump tank target temperature + [2°C] or
  2. If tank temperature < THERMO ON TEMP **AND** External Room Thermo OFF, switch to tank side.



## Characteristic of heat pump thermo ON/OFF under tank side condition

### Water Outlet Thermo condition

- Heat pump THERMO OFF TEMP:
  1. Heat pump THERMO OFF TEMP =  $53^{\circ}\text{C} + [+4^{\circ}\text{C}]$ .
  2. Water outlet temperature > Heat pump THERMO OFF TEMP for continuous 90 seconds, heat pump OFF and water pump continue ON.
- Next THERMO ON TEMP:
  1. THERMO ON TEMP = Water inlet when heat pump THERMO OFF +  $[-3^{\circ}\text{C}]$ .
  2. If water outlet temperature < THERMO ON TEMP **AND** External Room Thermo OFF, heat pump ON.

### Water Inlet Thermo condition

- Heat pump THERMO OFF TEMP
  1. Water inlet temperature >  $[55^{\circ}\text{C}]$  for continuous 30 seconds, heat pump OFF, water pump continue ON.
- Next THERMO ON TEMP:
  1. THERMO ON TEMP = Water inlet temperature  $<55^{\circ}\text{C}$ .
  2. If water inlet temperature < THERMO ON TEMP **AND** External Room Thermo OFF, heat pump ON.

### Solar Operation Condition (Only during solar priority is set condition)

- When solar request ON, solar valve will ON, turn OFF heat pump and water pump and switch 3 ways valve to room side.
- THERMO ON TEMP:
  1. THERMO ON TEMP = Heat pump tank target temperature +  $[-2^{\circ}\text{C}]$ .
  2. If tank temperature < THERMO ON TEMP **AND** External Room Thermo OFF **AND** Solar 3WV OFF, switch to tank side. Turn ON heat pump after water pump turns ON for 3 minutes.
- 3. Backup heater control:-
  - During External Room Thermo ON time, follow normal backup heater control operation.
  - During External Room Thermo OFF time, Backup heater OFF.
- 4. Booster heater control:-
  - Booster heater ON/OFF follow normal operation.
  - \* Under solar priority is set condition, when solar 3 way valve is ON, booster heater turn OFF.
- 5. Solar 3 way valve:
  - Solar 3 way valve operates follow solar operation specification.
  - \* Under solar priority is et condition, when solar 3WV turns ON, booster heater will turns OFF and 3 ways valve switch to room side.
  - \* Under solar priority is not set condition, solar 3WV will OFF when heat pump operate to tank side.
- 2 way valve open.

Heat + Tank Mode (Heating priority set)  
 Under Solar Priority Set Condition:

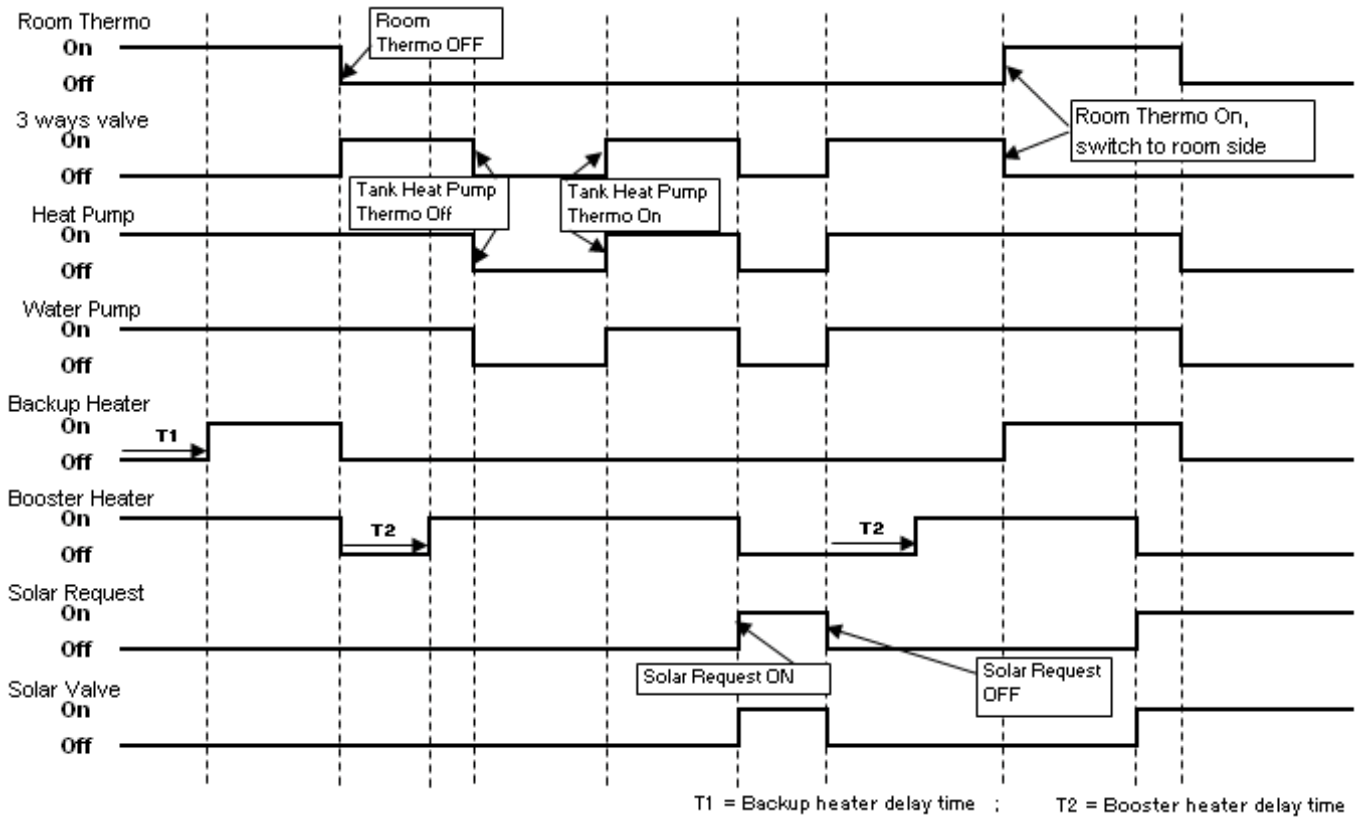

Under Solar Priority Not Set Condition:

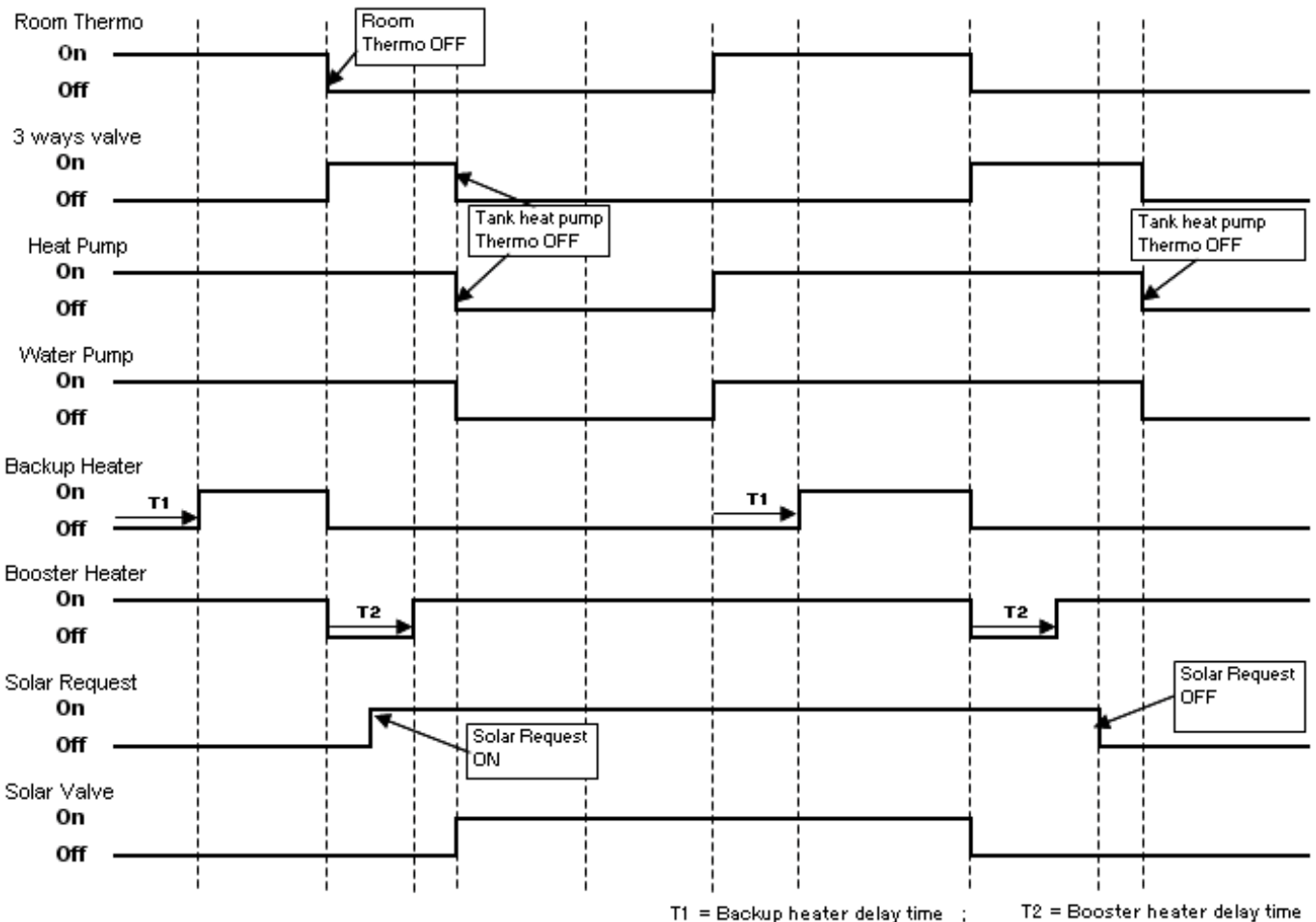

Setting 2: When heating priority is not set by control panel:

- When Solar Priority is set/not set by control panel:
  1. 3 ways valve control:
    - 3 ways valve switch to room side during heating heat-up interval, and switch to tank side during tank heat-up interval. Both modes will switch alternatively. Tank mode is the Initial running mode of this heat + tank mode (heating no priority).
  2. Heat pump operation control:
    - During heating heat-up interval
      - Follow normal heating operation
      - Under solar priority set condition:
        - Switch to tank heat-up interval and start counting tank heat-up timer when External Room Thermo OFF **AND** solar 3WV OFF **AND** Tank temperature < THERMO ON TEMP (End Room Interval Early) **OR**
        - Switch to tank heat-up interval and start counting tank heat-up timer when tank temperature < THERMO ON TEMP **AND** solar 3WV OFF.
      - Under solar priority not set condition:
        - Switch to tank heat interval and start counting tank heat-up timer when External Room Thermo OFF **AND** Tank < THERMO ON TEMP (End Room Interval) **OR**
        - Switch to tank heat-up interval and start counting tank heat-up timer when tank temperature < THERMO ON TEMP.
    - \* THERMO ON TEMP is defined Tank thermo ON/OFF condition below.
    - During tank heat-up interval
      - Heat pump tank target temperature = Tank set temperature or [50°C] whichever lower.
      - Heat pump Water Outlet set temperature is set to [53°C] during tank interval.
      - Initial Tank THERMO ON TEMP = heat pump tank target temperature + [-2°C].

Tank thermo ON/OFF characteristic:

- THERMO OFF TEMP:
  1. THERMO OFF TEMP = Heat pump tank target temperature + [0°C].
  2. Tank temperature > THERMO OFF TEMP for continuous 10 seconds after heat pump off due to water thermo, switch 3 ways valve to room side. End Tank heat-up interval and start count heating heat-up interval.
  3. Tank temperature > Tank set temperature + [2°C] for continuous 10 seconds, switch 3 way valve to room side. End Tank heat up interval and start count heating up interval.
- THERMO ON TEMP:
  1. THERMO ON TEMP = Heat pump tank target temperature + [-2°C].
  2. After heating heat-up interval, always detect tank temperature. Switch to next tank heat-up interval when tank temperature < THERMO ON TEMP.

## Characteristic of heat pump thermo ON/OFF under tank side condition

### Water Outlet Thermo condition

- Heat pump THERMO OFF TEMP:
  1. Heat pump THERMO OFF TEMP =  $53^{\circ}\text{C} + [+4^{\circ}\text{C}]$
  2. Water outlet temperature > Heat pump THERMO OFF TEMP for continuous 90 seconds, heat pump OFF but water pump continue ON.
- THERMO ON TEMP:
  1. THERMO ON TEMP = Water inlet temperature, when heat pump thermo OFF +  $[-3^{\circ}\text{C}]$ .

### Water Inlet Thermo condition

- Heat pump THERMO OFF TEMP:
  1. Water inlet temperature >  $[55^{\circ}\text{C}]$  for continuous 60 seconds, heat pump OFF.
- THERMO ON TEMP:
  1. THERMO ON TEMP = Water inlet temperature <  $[55^{\circ}\text{C}]$

### Solar Operation Condition (Only during solar priority is set condition)

- When solar pump ON, tank heat-up interval end early and 3 ways valve switch to room side.
  - THERMO IN TEMP:
    1. THERMO ON TEMP = Heat pump tank target temperature +  $[-2^{\circ}\text{C}]$ .
    2. After heating heat-up interval, always detect tank temperature. Switch to next tank heat-up interval when tank temperature < THERMO ON TEMP and solar 3 way valve OFF.
  - Tank interval will end and start heating interval timer, IF
    1. Tank interval timer finish **AND** External Room Thermo ON **OR**
      - Only when this condition occur at tank side before tank temperature thermo OFF switch to room side compulsory and continue until complete room heat-up interval and switch back to tank side.
    2. Fulfill Tank thermo OFF condition.
  - 3. Backup heater control:
    - During heating heat-up interval.
      - Follow normal back up heater control operation.
    - During tank heat-up interval.
      - Back up heater OFF during this interval.
  - 4. Booster heater control:
    - During heating heat up interval.
      - Booster heater ON/OFF according to booster heater operation control.
    - During tank heat-up interval.
      - Once switch from heating heat-up interval to tank heat-up interval, turn OFF the booster heater and start counting the BOOSTER HEATER DEPLAY TIMER.
      - Booster heater turn ON after BOOSTER HEATER DELAY TIMER fulfill and tank temperature lower than tank set temperature.
      - BOOSTER HEATER DELAY TIMER is clear when switch to heating heat-up interval.
  - 5. Solar 3 way valve
    - Solar 3WV operates follow solar operates specification.
      - \* Under solar priority is set condition, when solar 3WV is ON, booster heater turn OFF.
      - \* Under solar priority is not set condition, solar 3WV only can ON during heating heat-up interval.
  - 6. 2 way valve opens.

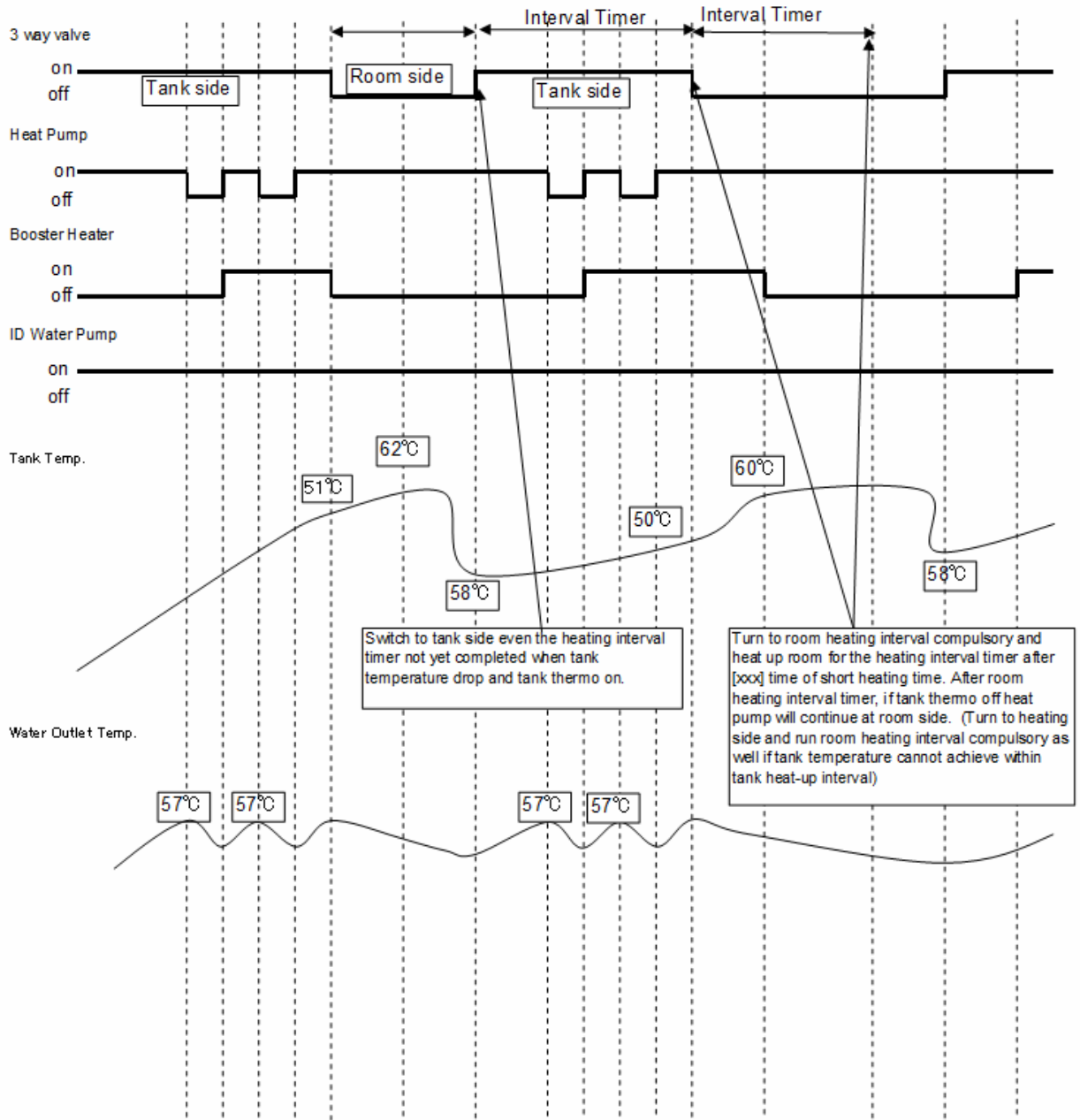

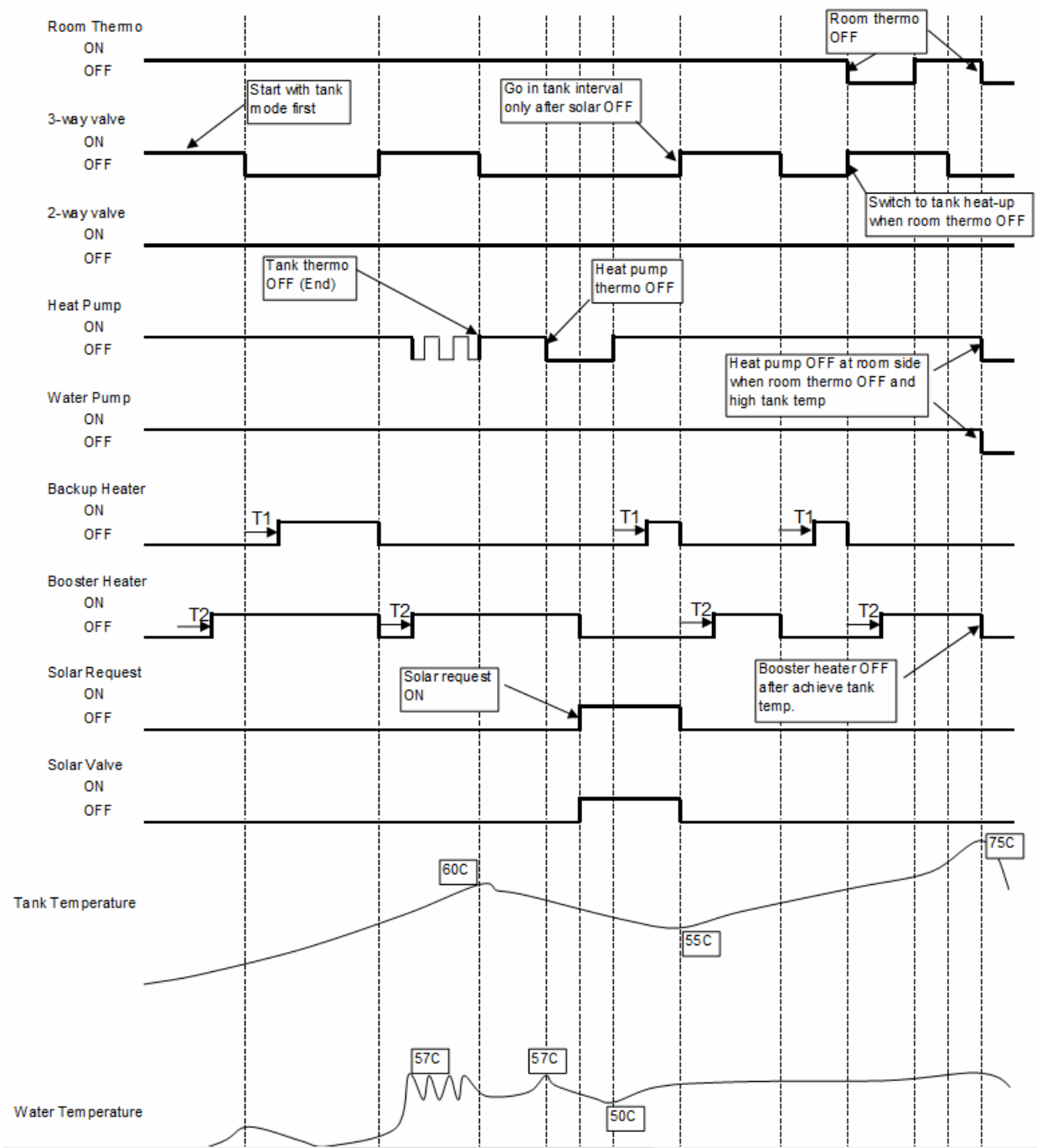

Heat + Tank Mode (Heating priority not set)  
 Under Solar Priority Not Set Condition:

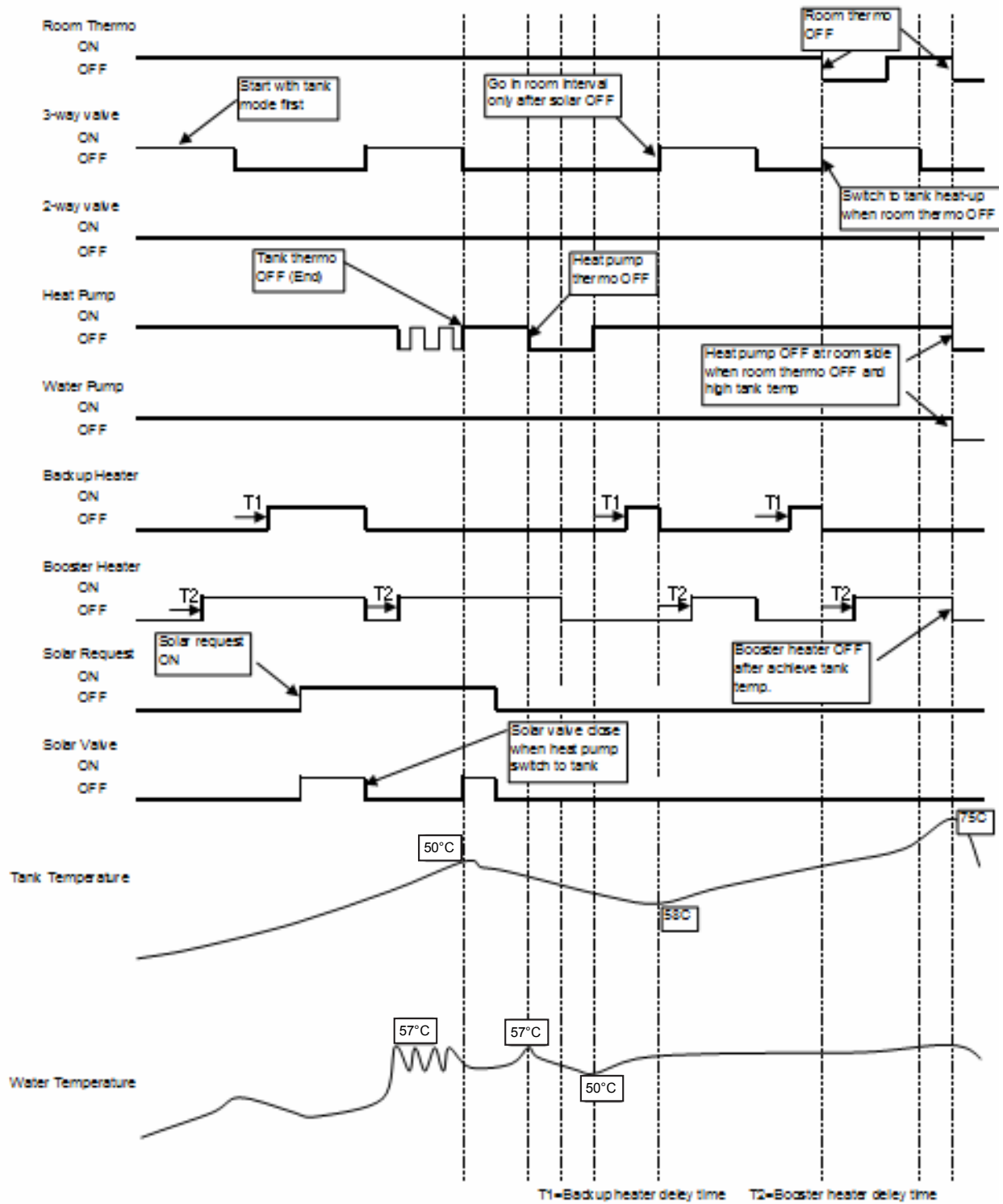

## 13.1.8 Cool + Tank Mode Operation

### 13.1.8.1 Cooling Priority SET

1. 3 ways valve control:
  - 3 ways valve switch to room side during External Room Thermo ON **OR** Tank Thermo OFF time, and switch to tank side at External Room Thermo OFF **AND** Solar 3 ways valve OFF.
2. Heat pump operation control:-  
**During External Room Thermo ON time:** (When room thermo ON heat pump must operate to room side).
  - **Heat pump operates follow normal operation at room side.**

#### **During External Room Thermo OFF time:**

- a) Switch 3 ways valve to tank side, IF  
Under Solar Priority Set condition:
  - Tank temperature > Tank THERMO OFF TEMP **AND** Solar Valve OFF.Under Solar Priority Not Set condition:
  - Tank temperature < Tank THERMO ON TEMP.
- b) Switch back 3 ways valve to room side, Heat pump and water pump turn OFF, IF  
Under Solar Priority Set condition:
  - Tank temperature > Tank THERMO OFF TEMP for continuous 10 seconds **OR** Solar Valve ON.Under Solar Priority Not Set condition:
  - Tank temperature > Tank THERMO OFF TEMP for continuous 10 seconds.

\*THERMO ON and THERMO OFF point refer to case below.

#### Operation condition when 3 ways valve switch to tank side:

- Tank water set temperature = tank set temperature or [55°C] whichever lower.
- Heat Pump Water Outlet set temperature is set to 53°C.
- Initial Tank THERMO ON TEMP = heat pump tank target temperature + [-2°C].

#### Tank Thermo ON/OFF characteristic

- THERMO OFF TEMP:
  1. THERMO OFF TEMP = Tank water set temperature + [0°C].
  2. Tank temperature > THERMO OFF TEMP for continuous 10 seconds, switch 3 ways valve to room side.
  3. Tank temperature > Tank set temperature + [2°C] for continuous 10 seconds, switch 3 ways valve to room side.
- Next THERMO ON TEMP:
  1. THERMO ON TEMP = Tank water set temperature + [-2°C].
  2. If tank temperature < THERMO ON TEMP **AND** External Room Thermo OFF, switch to tank side.



## Characteristic of heat pump thermo ON/OFF under tank side condition

### **a) Water Outlet Thermo Condition**

- Heat pump THERMO OFF TEMP:
  1. Heat pump THERMO OFF TEMP =  $[53^{\circ}\text{C}] + [+4^{\circ}\text{C}]$ .
  2. Water outlet temperature  $>$  Heat pump THERMO OFF TEMP for continuous 3 minutes, heat pump OFF.
- Next THERMO ON TEMP:
  1. THERMO ON TEMP = Water inlet when heat pump thermo OFF +  $[-3^{\circ}\text{C}]$ .
  2. When water outlet temperature  $<$  Heat pump THERMO ON TEMP, heat pump ON.

### **b) Water Inlet Thermo Condition**

- Heat pump THERMO OFF TEMP:
  1. Water inlet temperature  $>$   $[55^{\circ}\text{C}]$  for continuous 60 seconds, heat pump OFF.
- Next THERMO ON TEMP:
  1. THERMO ON TEMP = Water inlet temperature  $<$   $55^{\circ}\text{C}$ .

### **c) Solar Operation Condition (Only under Solar Priority Set Condition)**

- When solar request ON, solar valve will ON and switch 3 ways valve to room side.
  - THERMO ON TEMP:
    1. THERMO ON TEMP = Heat pump tank target temperature +  $[-2^{\circ}\text{C}]$ .
    2. If tank temperature  $<$  THERMO ON TEMP **AND** External Room Thermo OFF **AND** Solar 3WV OFF, switch to tank side.
3. Backup heater control:-
- Back-up heater does not operate at Cool + Tank Mode.
4. Booster heater control:-
- Booster heater ON/OFF follow normal operation.
  - \* Under solar priority is set condition, when solar 3 way valve is ON, booster heater turns OFF.
5. Solar 3 way valve:
- Solar 3 way valve operates follow solar operation specification.
  - \* Under solar priority is set condition, when solar 3WV turns ON, booster heater will turn OFF and 3 ways valve switch to room side.
  - \* Under solar priority is not set condition, solar 3WV will OFF when heat pump operates to tank side.
6. 2 ways valve control:
- 2 ways valve is closed.

### 13.1.8.2 Cooling Priority NOT SET

1. 3 ways valve control:
  - 3 ways valve switch to room side during room cooling interval and switch to tank side during tank heat-up interval. Both modes will switch alternately. Tank mode is the initial running mode of this cool + tank mode.
2. Heat pump operation control:-
  - a) During room cooling interval
    - Follow normal cooling operation.
    - Under Solar Priority Set condition:
      - Switch to tank heat-up interval and start tank heat-up timer when External Room Thermo OFF **AND** solar 3VW OFF **AND** Tank temperature < THERMO ON TEMP (End Room Interval Early) **OR**
      - Switch to tank heat-up interval and start counting tank heat-up timer when tank temperature < THERMO ON TEMP **AND** solar 3VW OFF.
    - Under Solar Priority Not Set Condition:
      - Switch to tank heat-up interval and start counting tank heat-up timer when External Room Thermo OFF **AND** Tank temperature < THERMO ON TEMP (End Room Interval Early) **OR**
      - Switch to tank heat-up interval and start counting tank heat-up timer when tank temperature < THERMO ON TEMP.

\* THERMO ON TEMP is defined from following tank thermo ON/OFF condition.

- b) During tank heat-up interval
  - Tank water set temperature = tank set temperature or 55°C whichever lower.
  - Heat Pump Water Outlet set temperature is set to [53°C].
  - Initial Tank THERMO ON TEMP = heat pump tank target temperature + [-2°C].

#### Tank Thermo ON/OFF characteristic

- THERMO OFF TEMP:
  - 1) THERMO OFF TEMP = Tank water set temperature + [0°].
  - 2) Tank temperature > THERMO OFF TEMP for continuous 10 seconds, 3 ways valve is switch to room side. End Tank heat-up interval and start count cooling interval.
  - 3) Tank temperature > Tank set temperature + [2°] for continuously 10 seconds, 3 ways valve is switch to room side. End Tank heat-up interval and start count cooling interval.
- THERMO ON TEMP:
  - 1) THERMO ON TEMP = Tank water set temperature + [-2°C].
  - 2) During cooling interval or external room thermo OFF, always detect tank temperature. Switch to next tank heat-up interval when tank temperature < THERMO ON TEMP.

#### Case 2:

- Heat pump THERMO OFF TEMP:
  - 1) Heat pump THERMO OFF TEMP = [53°C] + [+4°C].
  - 2) Water outlet temperature > Heat pump THERMO OFF TEMP for continuous 3 minutes, heat pump OFF.
- THERMO ON TEMP:
  - 1) THERMO ON TEMP = Water inlet when heat pump thermo OFF + [-3°C].

### Water Inlet Thermo Condition

- Heat pump THERMO OFF TEMP:
  - 1) Water inlet temperature > [55°C] for continuous 60 seconds, heat pump OFF.
- THERMO ON TEMP:
  - 1) THERMO ON TEMP = Water inlet temperature > [55°C].
- c) Solar Operation Condition (Only under Solar Priority Set Condition)
  - When solar pump ON, tank heat-up interval end early and 3 ways valve switch to room side.
  - THERMO ON TEMP:
    - 1) THERMO ON TEMP = Heat pump tank target temperature + [-2°C].
    - 2) After cooling interval or external room thermo OFF, always detect tank temperature. Switch to next tank heat-up interval when tank temperature < THERMO ON TEMP.
  - Tank interval will end and start cooling interval timer, IF
    - 1) Tank interval timer finish **AND** External Room Thermo ON **OR**  
Only when this condition occur at tank side before case 1 thermo OFF, switch to room side is compulsory and continue until complete cooling interval and switch back to tank side.
    - 2) Fulfill case 1 of thermo OFF condition.
- 3. Backup heater control:
  - a) Backup heater does not operate at Cool + Tank Mode.
- 4. Booster heater control:
  - a) During cooling interval
    - Booster heater ON/OFF according to booster heater operation control.
  - b) During tank heat-up interval
    - Once switch from cooling interval to tank heat-up interval, booster heater is turns OFF and BOOSTER HEATER DELAY TIMER starts counting.
    - Booster heater turns ON after BOOSTER HEATER DELAY TIMER fulfill and tank temperature lower than tank set temperature.
    - BOOSTER HEATER DELAY TIMER is clear when switch to cooling interval.
- 5. Solar 3 ways valve
  - Solar 3WV operates follow solar operation specification.

\* Under solar priority is set condition, when solar 3WV is ON, booster heater turns OFF.  
\* Under solar priority is not set condition, solar 3WV only can ON during cooling interval.
- 6. 2 ways valve control:
  - 2 ways valve is closed.

### 13.1.9 Setting Water Outlet Temperature for Heat Mode

- The set temperature defines the parameters for the outdoor ambient temperature dependent operation of the unit. Where by the internal water setting temperature is determined automatically depending on the outdoor temperature. The colder outdoor temperatures will result in warmer water and vice versa. The user has the possibility to shift up or down the target water temperature by control panel setting.

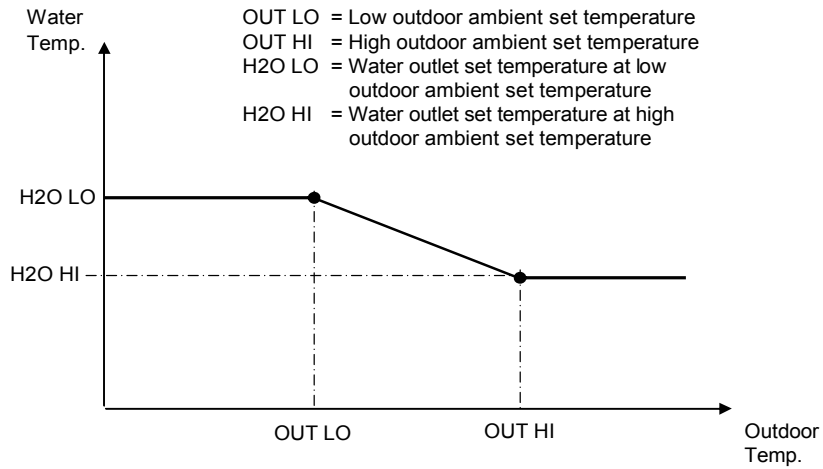

- Outdoor temperature is updated every 30 minutes when operation ON.
- Setting water outlet temperature always follow H2O (Lo) or H2O (Hi) whenever is higher if outdoor ambient sensor or indoor communication error happen.

#### Operation under tank mode

- When heat pump operate to tank side, the water outlet target temperature is 53°C.

### 13.1.10 Water Temperature Thermo Shift Setting

- Switchs are ignored during “PUMPDW” = ON.
- Switchs are ignored during “STATUS” = ON.
- “▲”, “▼”, ”SELECT” switch are ignored if “SETTING” = OFF.
- “CANCEL” switch is ignored if “SETTING” = OFF & “STATUS” = OFF.
- If “SET” Switch pressed for less than 5secs, immediately enter water temperature shift setting mode.
- Once enter this setting mode, “SETTING” display is ON.  
This setting mode is used to easily shift the target water outlet temperature.

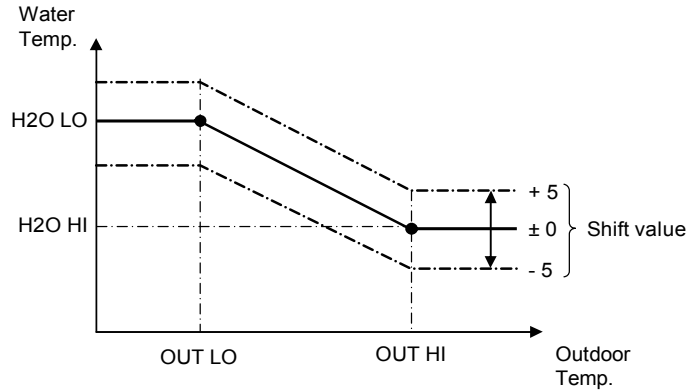

OUT LO = Low outdoor ambient set temperature  
 OUT HI = High outdoor ambient set temperature  
 H2O LO = Water outlet set temperature at low outdoor ambient set temperature  
 H2O HI = Water outlet set temperature at high outdoor ambient set temperature  
 Shift value = Setting water temperature thermo shift

### 13.1.11 Outdoor Fan Motor Operation

Outdoor fan motor is adjusted according to operation condition. It starts when compressor starts operation and it stops 30 seconds after compressor stops operation.



## 13.2 Water Pump

### 13.2.1 Water Pump Control

- Once the indoor unit is ON, the water pump will be ON immediately and no error judgement for 9 minutes. However, during this 9 minutes operation, if there is any abnormality cause at outdoor or malfunction, the compressor should be OFF immediately and restart delay after 3 minutes.
- The system will start checking on the water flow level after operation start for 9 minutes. If water flow level is detected low continuously 10 seconds, the water pump and the compressor will be OFF permanently and OFF/ON control panel LED will blink (H62 error occurs).
- When error happens, the power has to be reset to clear the error.
- If there is no error indication, the water pump shall be continuously running.
- The water pump will remain ON when compressor OFF due to thermostat OFF setting is reached.
- Water pump must always operate during heating mode, deice operation and also during heater ON condition.
- Water pump will stops 15 seconds after the unit stops operation.

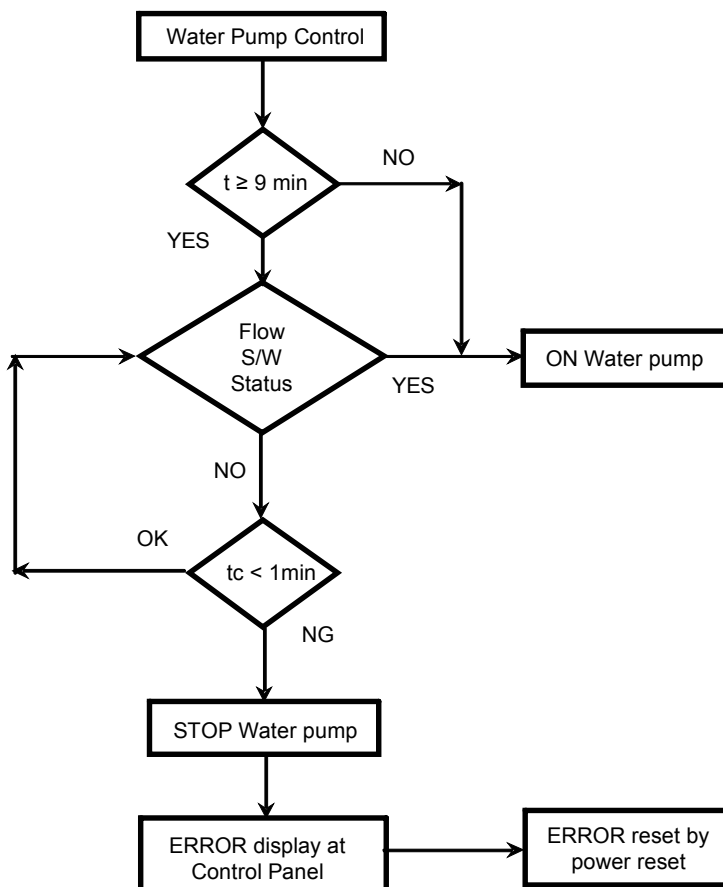

### 13.2.2 A-class Pump Specification

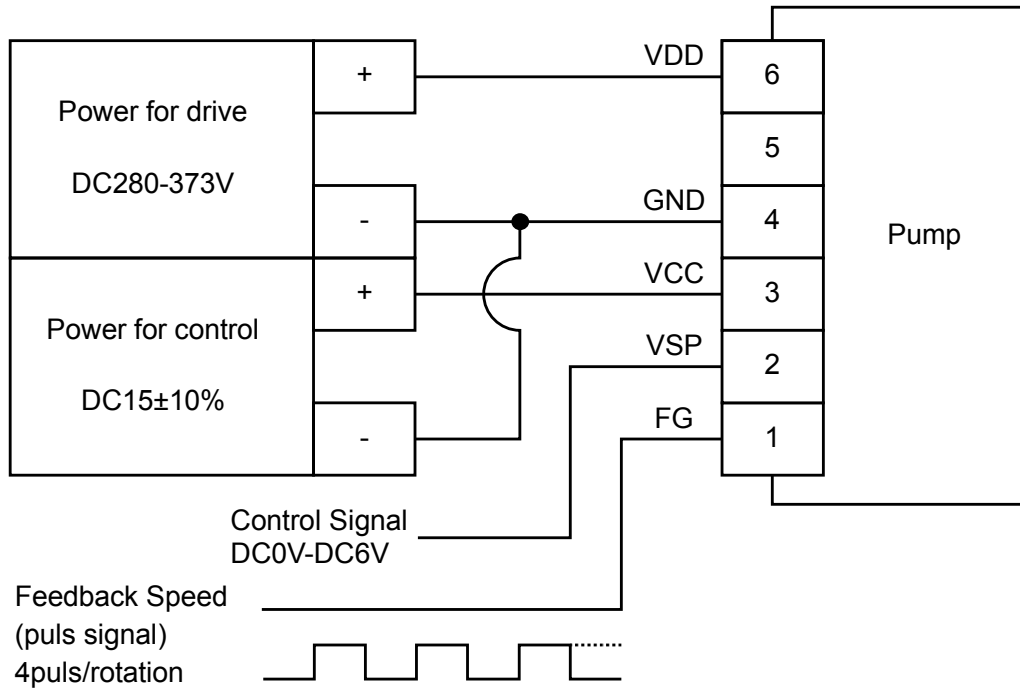

Control signal is analog voltage (DC0V-6V) generated by microcomputer PWM port. Microcomputer can change analog voltage by changing PWM duty.

### 13.2.3 Water Flow Rate Setting

- Set water pump speed to adjust the water flow rate.

Depend on the hydraulic system pressure loss and type, the water flow rate can be adjusted by control panel.

- 1 Press SERVICE button for 5 seconds.
- 2 Press ▲ button to enter menu S02 and press SET button.
- 3 Press SELECT button then press ▲/▼ button to change SPEED and press SET to confirm.
- 4 Press OFF/ON button to quit setting.

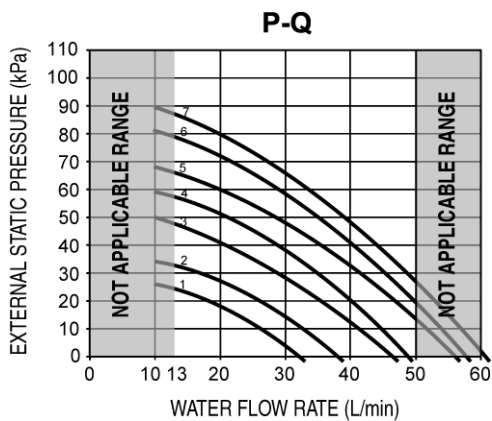

(WH-SDC9F3E8 WH-SDC12F9E8)

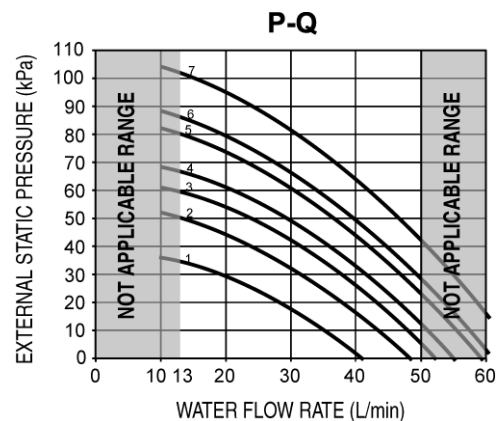

(WH-SDC14/16F9E8)

Note:

\* Before adjust the water flow rate, make sure that the total water volume in the installation is minimum 50 litres for heating side.

\* Please ensure the minimum flow rate is not less than 13l/min and not more than 50l/min.

### 13.2.4 Water Pump Speed Feedback Error

- Basically pump speed feedback is control by micon.
- When pump speed is below low limit or over high limit for a few seconds, micon detect pump error and system is stopped.
- Error detection conditions:
  - Current pump speed < 1000 rpm or
  - Current pump speed > 6000rpm for 10 seconds.
- Control contents:
  - When error occurs, water pump, heating and heater is stopped for 30 seconds then restart again (Retry control).
  - When micon detect error again, system is stopped and error code [H20] is displayed at control panel.

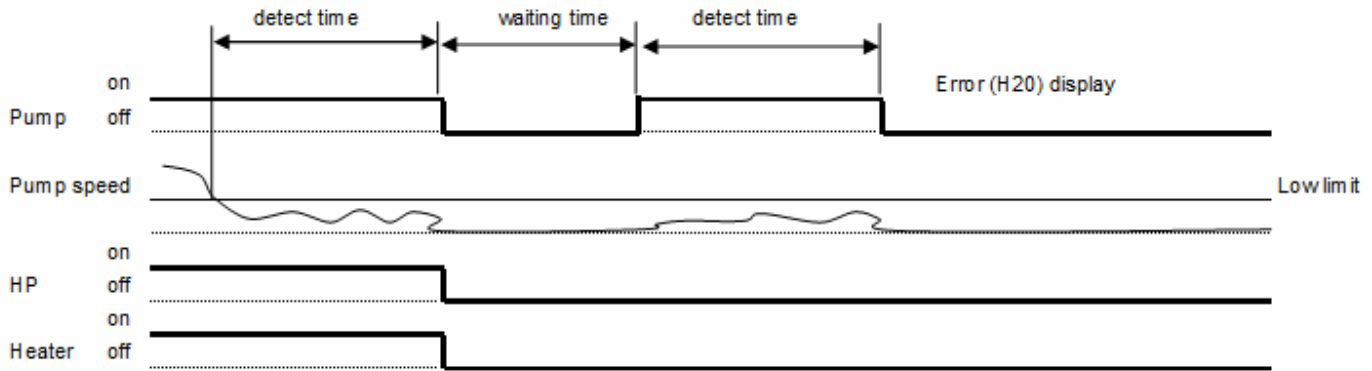

### 13.2.5 Water Pump Only Operation

#### Purpose

Circulate and fill the piping with water during installation time

- Water pump only circulation can be set from the control panel SERVICE S/W when the operation is in Standby Mode.
- Press the SERVICE S/W for continuous 5 sec to enter Service Mode.
- In Service Mode, select SR: 02 and press SET S/W to start water pump only operation.
- 3 way valve turn OFF and 2 way valve turn ON.
- Water pump will stop operation when H62 is triggered.
- Press the OFF/ON button to stop the water pump only operation.

### 13.3 Pump Down Operation [Service Mode: 01]

#### Purpose

Ensure the pump down operation when relocating or disposing of the unit. The pump down operation will extract all refrigerant from the piping into the outdoor unit.

Controls:

- 1 Press the SERVICE S/W for continuous 5 seconds to enter Service Mode.
- 2 In service mode, select Sr: 01 and press SET S/W to start Pump Down operation.
- 3 There will be no low pressure error and freeze prevention judgement during Pump Down operation.
- 4 3 ways valve will shift to room side and 2 ways valve will turn ON.
- 5 Press OFF/ON button to stop the unit.

### 13.4 Flow Switch

#### 13.4.1 Flow Switch Control

- 1 The water flow switch serves as an overload protector that shuts down the unit when the water level is detected to be low.
- 2 Detection is Lo (0 V) when there is no water flow, and detection is Hi (5 V) when there is water flow.



### 13.5 Indoor Unit Safety

#### 13.5.1 Indoor Unit Safety Control

- 1 When water pump is ON, the system will start checking flow switch status (ON/OFF).
- 2 If the flow switch ON for 10 seconds, the system will check on the water inlet temperature for 10 seconds. If the water inlet temperature not exceeds 80°C, the water pump shall be continuously running with normal mode.  
If the water inlet temperature exceeds 80°C for continuously 10 seconds, the water pump will be OFF immediately.
- 3 After water pump OFF for more than 10 minutes, it will be ON back and the indoor unit safety control checking is restarted.

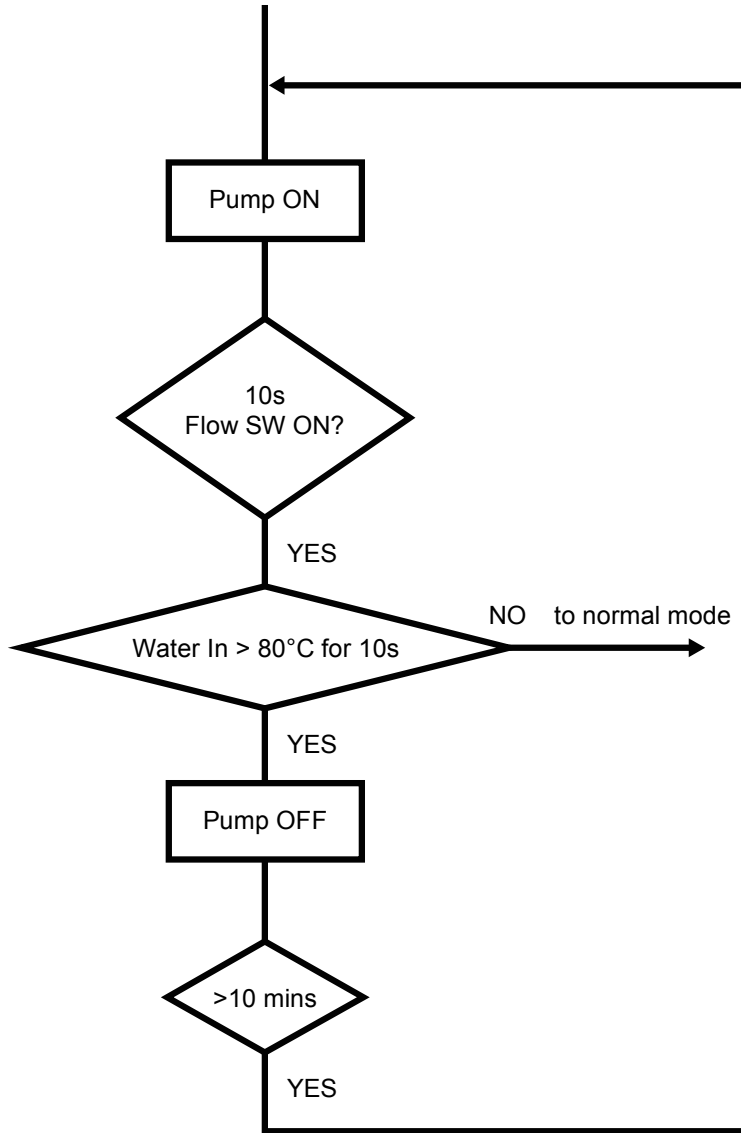

### 13.6 Auto Restart Control

- 1 When the power supply is cut off during the operation of Air-to-Water Heatpump, the compressor will re-operate after power supply resumes.

### 13.7 Indication Panel

LED	Operation
Color	Green
Light ON	Operation ON
Light OFF	Operation OFF

Note:

- If Operation LED is blinking, there is an abnormality operation occurs.

## 13.8 Indoor Back-Up Heater Control

### 13.8.1 Indoor Electric Heater Control

- 1 Normal Heating Mode
  - Heater On condition:
    - a. Heater switch is ON
    - b. After Heatpump thermo ON for **[30]** mins
    - c. After water pump operate **[9]** mins
    - d. Outdoor air temperature < Outdoor set temperature for heater
    - e. When water outlet temperature < Water set temperature + **[-8°C]**
    - f. **[20]** minutes since previous Backup heater Off
      - \* When heatpump cannot operate due to error happens during normal operation, heater will go into force mode automatic
      - \* Heater need to operate during deice operation
  - Heater Stop Condition:
    - a. When outdoor set temperature > outdoor set temperature + **[+2°C]** for continuous 15 secs OR
    - b. When water out temp > water set temperature + **[-2°C]** for continuous 15 secs OR
    - c. Heater switch is Off OR
    - d. Heatpump thermo-off or OFF condition
- 2 Force Heater Mode
  - Heater On condition:
    - a. After water pump operate **[9]** mins
    - b. When water outlet temperature < water set temperature + **[-8°C]**
    - c. **[20]** minutes since previous Backup heater Off
  - Heater Stop condition
    - a. Force mode off **OR**
    - b. When water outlet temperature > water set temperature + **[-2°C]** for continuous 15 secs

\* Do not operate heater at the following situation

- 1 Water outlet temperature sensor, and water inlet sensor abnormal
- 2 Flow switch abnormal
- 3 Circulation pump stop condition
- 4 During Heatpump switch to tank side

## 13.9 Tank Booster Heater Control

### 13.9.1 Tank Booster Heater Control

Heating operation condition:

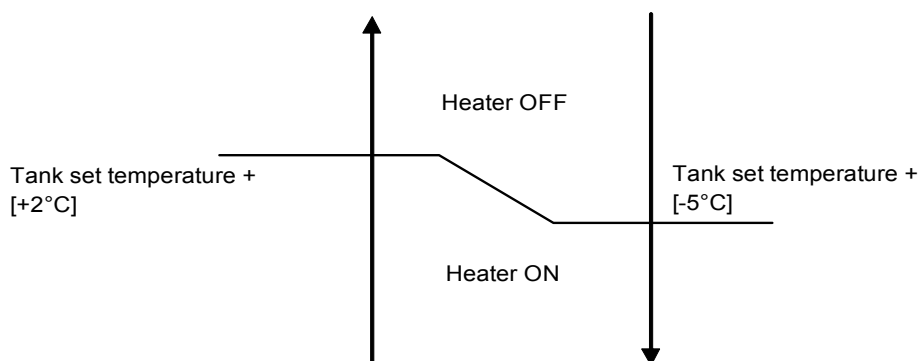

- 1 Booster heater Turn On condition:
  - After BOOSTER HEATER DELAY TIMER fulfill during heatpump startup time in tank mode, or during switching from heating heat-up interval to tank heat-up interval in heat + tank mode (heating priority not set).
  - Tank temperature < Tank set temperature + [-5°C],
  - 20 minutes since previous heater off.

\* BOOSTER HEATER DELAY TIMER is clear when tank heat-up interval end.
- 2 Booster heater Turn Off condition:
  - Tank temperature > Tank set temperature + [+2°C] for continuous 15 sec
  - When BOOSTER HEATER DELAY TIMER start count after switch from heating heat-up interval to tank heat-up interval

\* DELAY TIMER can be set by control panel.

### 13.10 Base Pan Heater Control (Optional)

- To enable the base pan heater function, control panel initial setting has to be manually adjusted by activating Base Pan Heater menu.
- There are 2 optional start condition can be selected, Type A or Type B.
- Control details:
  - 1 Type A: (Default Auto Mode)
    - Start conditions:
      - When outdoor air temperature  $\leq 3^{\circ}\text{C}$  during heating and deice operation is ON.
    - Control contents:
      - Base pan heater is ON during deice operation and continues ON for 10 minutes after deice operation ends.
    - Cancel condition:
      - When outdoor temperature  $> 6^{\circ}\text{C}$  after deice end or
      - When operation is not at heating mode or
      - Base pan heater ON timer count is completed.
  - 2 Type B: (ON Mode)
    - Start conditions:
      - When outdoor air temperature is  $\leq 5^{\circ}\text{C}$  and operates in heating mode, base pan heater is ON.
    - Cancel conditions:
      - When outdoor air temperature is  $> 7^{\circ}\text{C}$  or
      - When operation is not at heating mode.

Note:

\* Base pan heater cannot be ON during test mode and stand by mode.

## 13.11 Sterilization Mode

- Purpose:
  - To sterilize water tank by setting the required boiling temperature.
- Control start condition:
  - Tank connection menu is set to YES by control panel.
  - Sterilization menu is set to YES by control panel.
  - Sterilization signal received from control panel by timer.
- Control stop condition:
  - After sterilization timer completed or
  - After 4 hours of operation since sterilization function starts.
- Control content:
  - Once the sterilization function is enable, set the target sterilization set temperature.
  - Booster heater will allow to ON during solar SET condition.
    - Booster heater OFF Temp = Sterilization set temperature +0°C
    - Booster heater ON Temp = Sterilization set temperature -7°C
  - Sterilization timer which set by control panel will start count after tank achieve sterilization set temperature.
  - Target tank temperature will set back to normal tank set temperature.

\* Tank heater control is not affected by solar pump when solar priority set.

## 13.12 Quiet Operation

- Purpose:
  - To provide quiet operation compare to normal operation by reduces outdoor unit noise.
- Starting condition:
  - When quiet button is presses.
  - When quiet is request to ON by weekly timer. (Refer to control panel)
- When any of above mentioned condition is achieved, this control is activated.  
New target FM speed = Present target FM speed – 80 rpm  
Minimum target FM speed = 200 rpm
- Cancellation condition:
  - Cancel by pressing quiet button.
  - Stop by OFF/ON button
  - When quiet is request to OFF by weekly timer.

### 13.13 Anti Freeze Control

- Anti freeze protection control menu can be set YES or NO by control panel.
- In heatpump system, there are 3 types of anti freeze control:
  1. Expansion tank anti-freeze control
    - Expansion tank anti freeze heater ON condition:
      - Outdoor ambient temp.  $< 3^{\circ}\text{C}$
    - Expansion tank anti freeze heater OFF condition:
      - Outdoor ambient temp.  $> 4^{\circ}\text{C}$
  2. Water pump circulation anti freeze control
    - Water pump turns ON when **ALL** below conditions are fulfilled:
      - Heatpump OFF (stand by) OR error occurs.
      - Water flowing flag is ON.
      - Water flow switch is not abnormal.
      - Outdoor ambient temp.  $< 3^{\circ}\text{C}$  OR outdoor ambient temp. sensor is abnormal.
      - Water inlet/outlet temp.  $< 6^{\circ}\text{C}$ .
      - After 5 minutes from previous water pump OFF.
    - Water pump turn OFF when **ANY** of below conditions is fulfilled:
      - Outdoor ambient temperature  $\geq 4^{\circ}\text{C}$ .
      - During  $-5^{\circ}\text{C} < \text{outdoor ambient temp.} < 4^{\circ}\text{C}$ 
        - After water pump ON for 4 minutes, and water inlet temp.  $\geq 8^{\circ}\text{C}$ .
        - Else, shift to back up heater anti freeze control.
      - During outdoor ambient temp.  $< -5^{\circ}\text{C}$ 
        - After water pump ON for 4 minutes, and water inlet/outlet  $\geq 20^{\circ}\text{C}$ .
        - Else, shift to back up heater anti freeze control.
    - However, if flow switch is abnormal (H62), then water pump circulation anti freeze control will not activate.
  3. Back up heater anti freeze control:
    - Back up heater turn ON when **ALL** below conditions is fulfilled:
      - Water inlet/outlet temp.  $< 6^{\circ}\text{C}$ .
      - Water pump circulation anti freeze control activated and water pump ON for 4 minutes.
    - Back up heater turns OFF when ANY of below conditions is fulfilled:
      - Water inlet/outlet temp.  $> 28^{\circ}\text{C}$ .
      - Water pump circulation anti freeze control deactivated/water pump OFF.
    - However, if back up heater is abnormal (H70) then back up heater anti freeze control will not activate.

## 13.14 Solar Operation (Optional)

### 13.14.1 Solar Operation:

- 1 External solar heat source signal can be connect to unit for proper control of heat source switching during tank boiling time.
- 2 Control according to preset whether solar priority is set or not.
- 3 When tank connection is NOT set at SETTING mode, solar operation is disabled.
- 4 When Pump A (from solar pump station) is detected On through connection Y3 and Y4, then the Solar pump 3 Way Valve is requested ON (Refer to figure below).

#### Connecting diagram with the Solar Pump Station

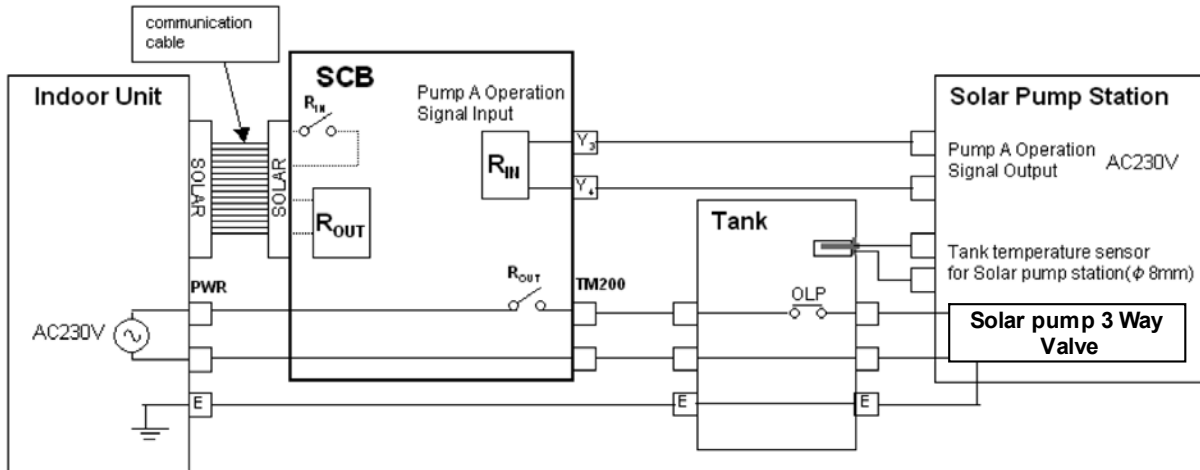

### 13.14.2 Solar Operation Control

When solar priority is SET

- 1 Operation condition:
  - a 3 way valve operates if all of the following conditions are fulfilled:
    - Power On. (regardless operation ON or OFF)
    - There is operation request from solar pump station.
    - Tank hot water temp is below solar on upper limit temp 72°C.
- 2 Stop condition:
  - a 3 way valve stops operating when:
    - No power supply to unit **OR**
    - There is **NO** operation request from solar pump station **OR**
    - Tank hot water temp is above solar off upper limit temp 80°C.

\* heat pump OFF OR operate to room side when solar pump operate during solar priority set.  
 \* booster heater OFF when solar pump operate during solar priority set.

When solar priority is NOT SET

- 1 Operation condition:
  - a 3 way valve operates if all of the following conditions are fulfilled:
    - Power On. (regardless operation ON or OFF)
    - There is operation request from solar pump station.
    - Tank hot water temp is below solar on upper limit temp 72°C.
    - Heat pump thermo OFF in tank mode OR Heat pump operate to room side (during operation ON and tank mode selected).
- 2 Stop condition:
  - a 3 way valve stops operating when:
    - No power supply to unit **OR**
    - There is **NO** operation request from solar pump station **OR**
    - Tank hot water temp is above solar off upper limit temp 80°C.
    - Heat pump thermo ON and operate to tank side. (during operation ON and tank mode selected)

## Solar Operation Chart in different mode and condition

### Tank Mode (Solar Priority SET condition)

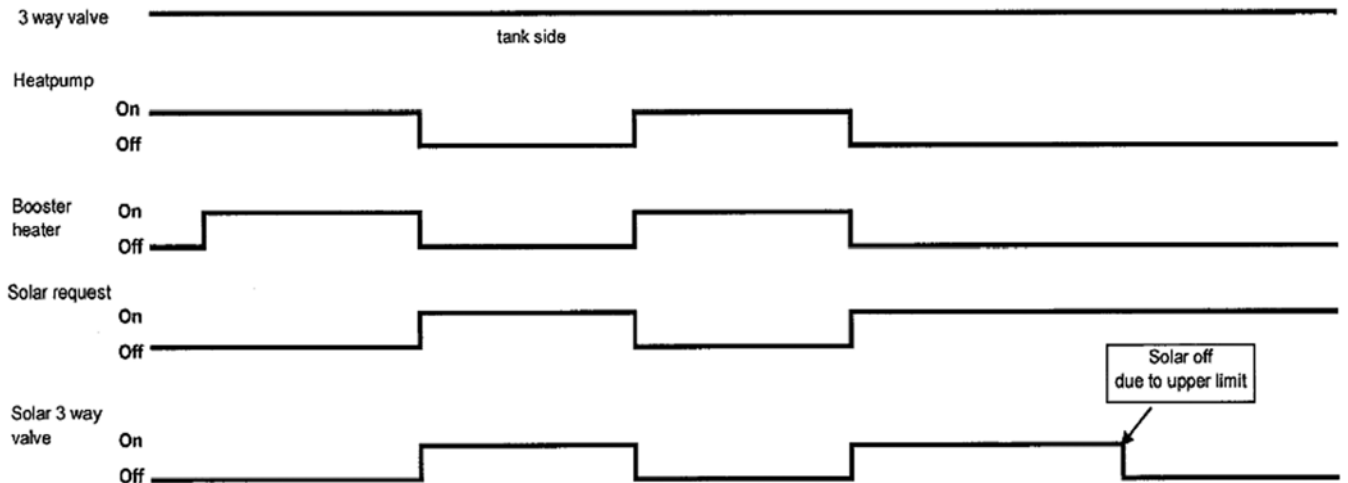

### Tank Mode (Solar Priority NOT SET condition)

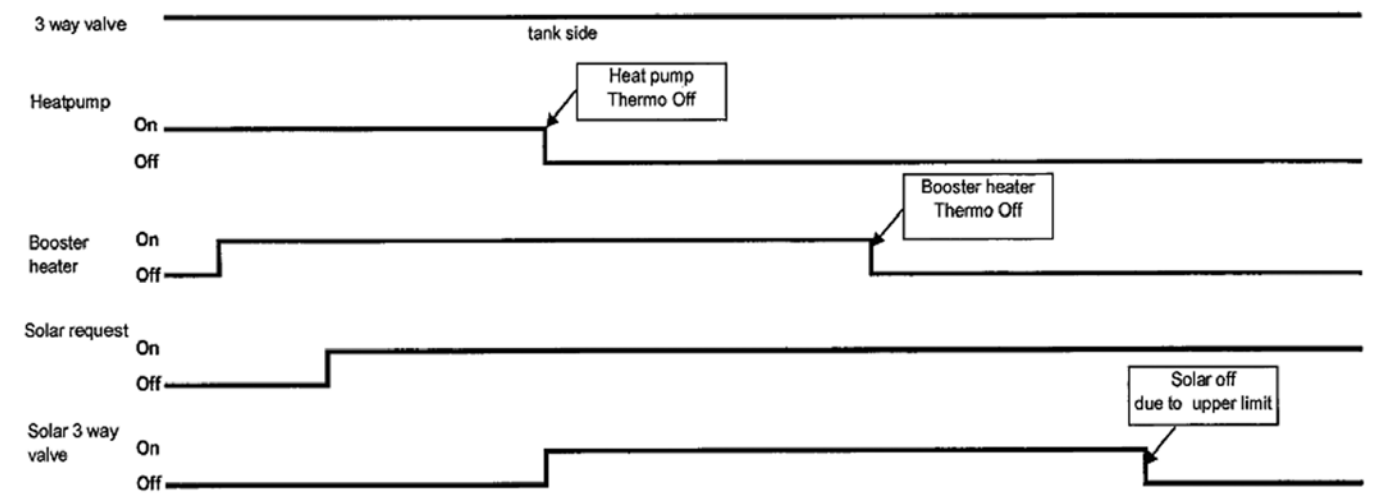

**Heat + Tank Mode (Heating Priority NOT SET) (Solar Priority SET condition)**

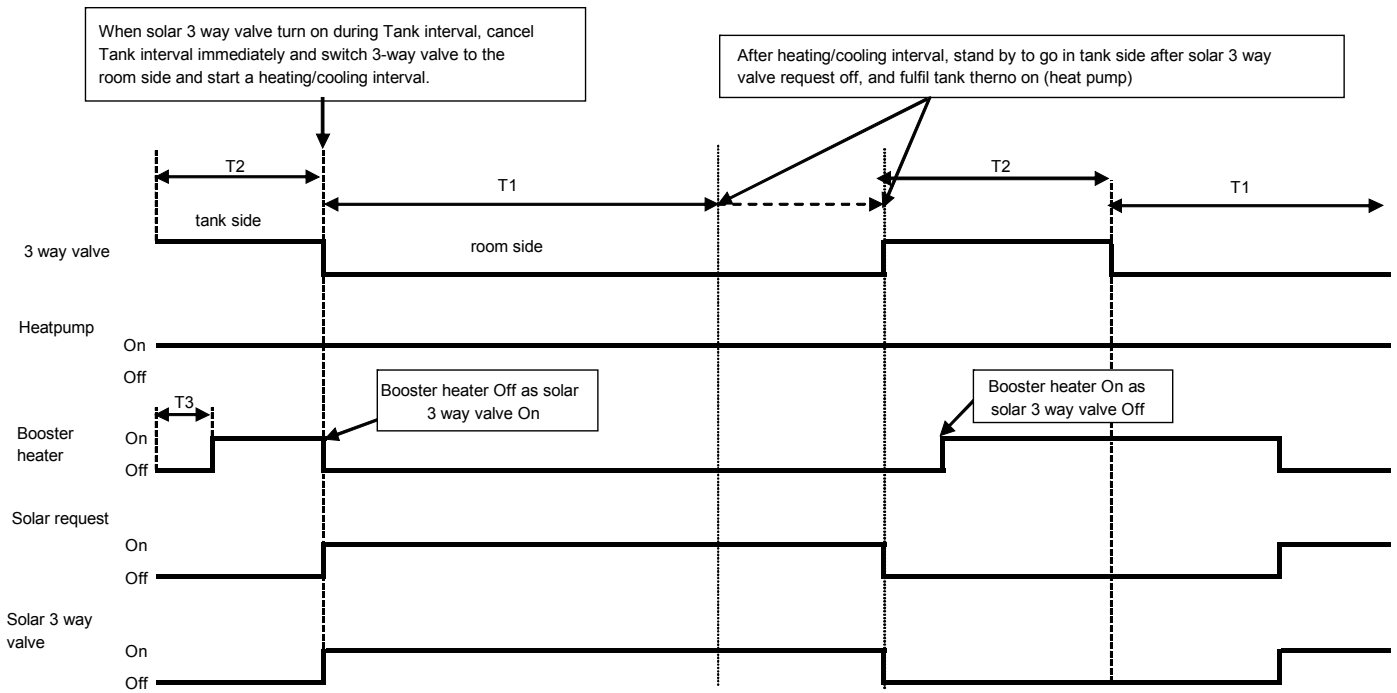

**Heat + Tank Mode (Heating Priority NOT SET) (Solar Priority NOT SET condition)**

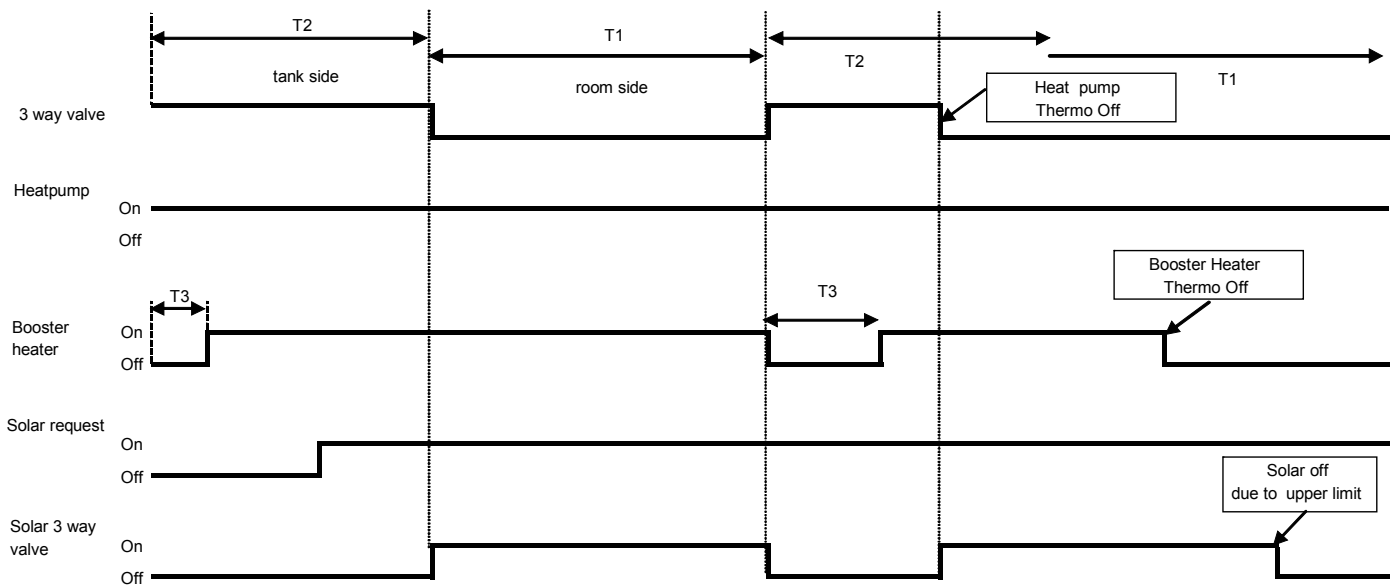

T1 - Heating  
 T2 - Tank interval  
 T3 - Booster heater delay timer



# Heat + Tank Mode (Heating Priority SET) & Cool + Tank Mode

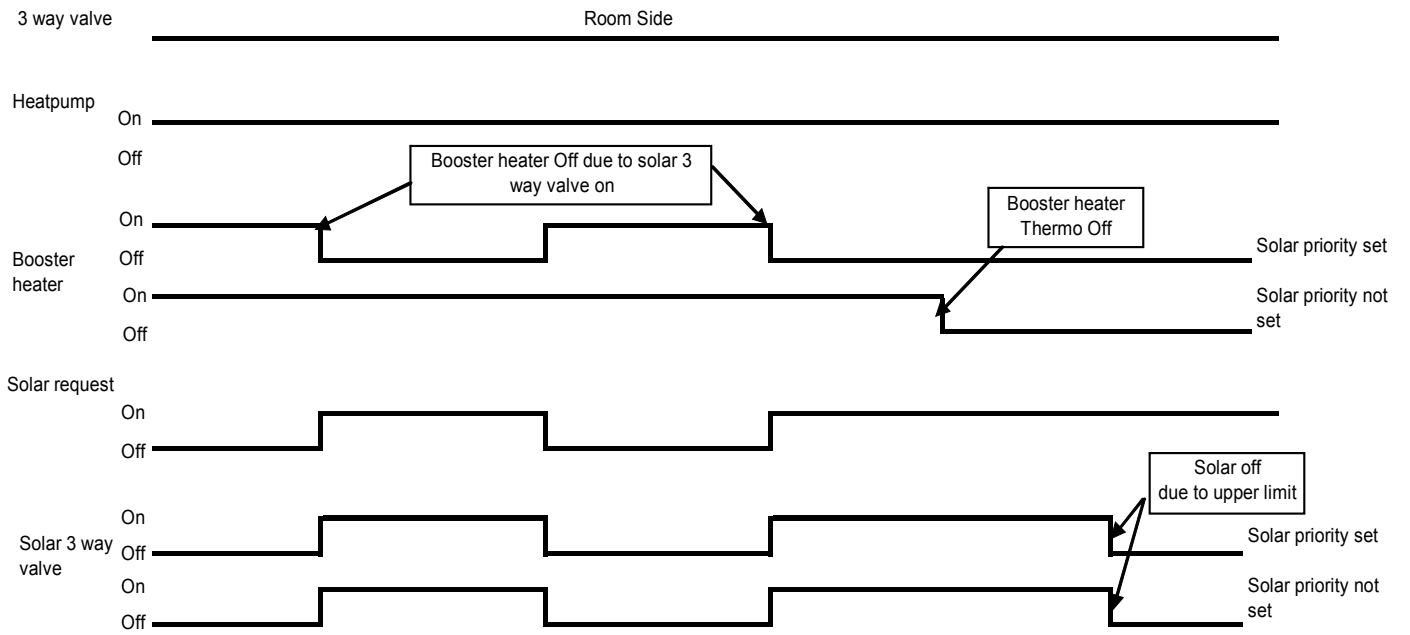

### 13.15 External Room Thermostat Control (Optional)

Purpose:

- Better room temperature control to fulfill different temperature request by external room thermostat.  
Recommended external room thermostat:

Maker	Characteristic
Siemen (REV200)	Touch panel
Siemen (RAA20)	Analog

Connection of external room thermostat:

Wire Connection and thermo characteristic of Siemen REV200:

Setting	L/L1 (H)	Heat Thermo	L/L2 (C)	Cool Thermo
Set Temp < Actual Temp	Open Circuit	OFF	Short Circuit	ON
Set Temp > Actual Temp	Short Circuit	ON	Open Circuit	OFF

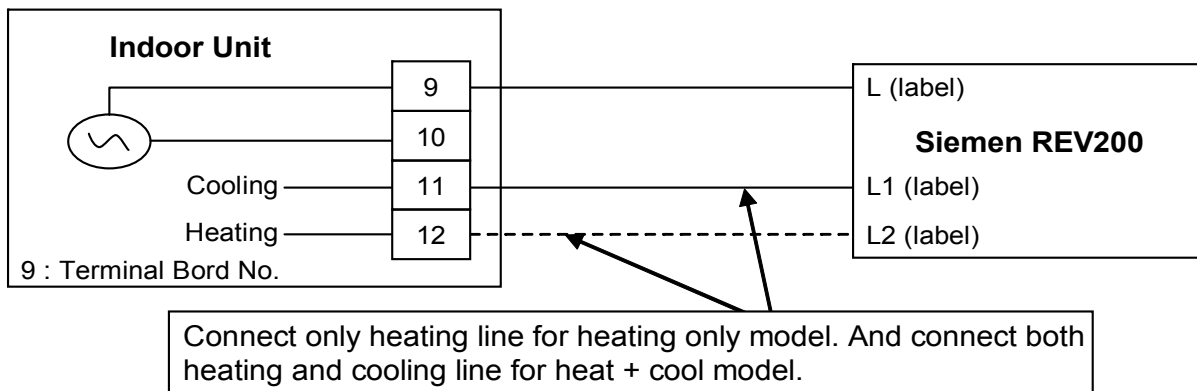

Wire Connection and thermo characteristic of Siemen RAA20:

Setting	L/Y1 (H)	Heat Thermo	L/Y2 (C)	Cool Thermo
Set Temp < Actual Temp	Open Circuit	OFF	Short Circuit	ON
Set Temp > Actual Temp	Short Circuit	ON	Open Circuit	OFF

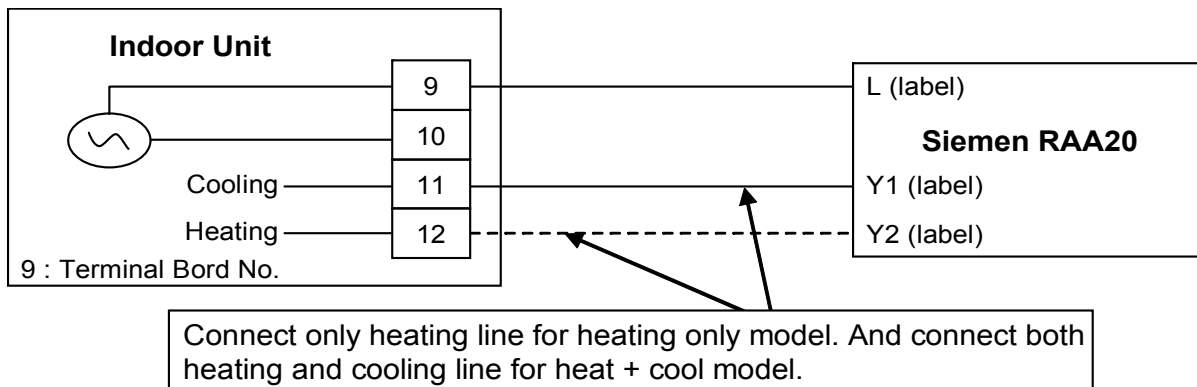

Control Content:

- External room thermostat control activate only when remote thermostat connection select YES by Indoor control panel.
- When indoor running heat mode, refer thermo On/Off from heating line feedback. And when indoor running cool mode, refer thermo On/Off from cooling line feedback.
- Heat pump Off immediately when receive thermo off feedback.

### 13.16 Three Ways Valve Control

**Purpose:**

- 3 ways valve is used to change flow direction of hot water from heat pump between heating side and tank side.

**Control contents:**

- 1 3 ways valve switch Off:
  - o During 3 ways valve switch Off time, the hot water will provide heat capacity to heating side.
- 2 3 ways valve switch On:
  - o During 3 ways valve switch On time, the hot water will provide heat capacity to tank side.
- 3 Stop condition:
  - o During stop mode, 3 ways valve will be in switch off position.

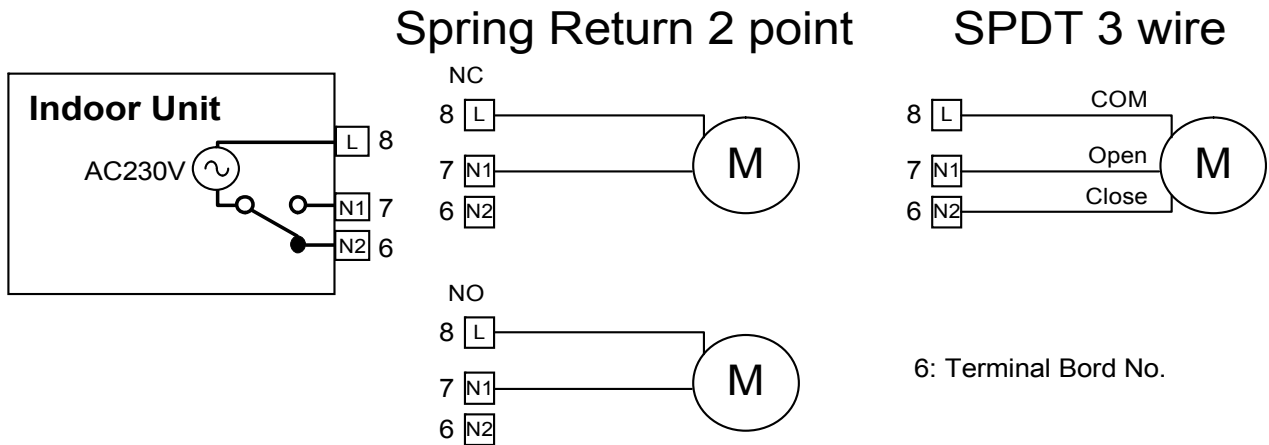

\* During pump down and force mode, fix 3 ways valve in close condition.

\* Recommended Parts : SFA 21/18 (Siemens)

### 13.17 Two Ways Valve Control

**Functionality of 2 ways valve:**

- Use to allow hot water to floor heating panel or block cold water to floor heating panel.

**Control contents:**

- 1 When indoor running in heat mode, OPEN the 2 ways valve.
- 2 When indoor running in cool mode, CLOSE the 2 ways valve.
- 3 Stop condition:
  - a. During stop mode, fix 2 ways valve in close condition.

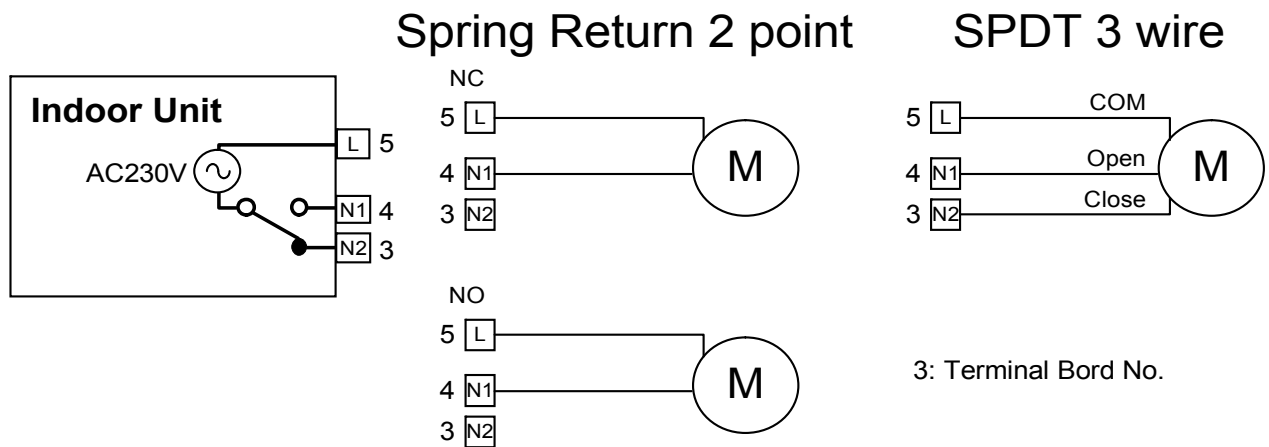

\* During pump down mode, fix 2 ways valve in close condition.

\* During force mode, open 2 ways valve.

\* Recommended Parts : SFA 21/18 (Siemens)

### 13.18 External OFF/ON Control

- Communication circuit between indoor unit and external controller is as per below.

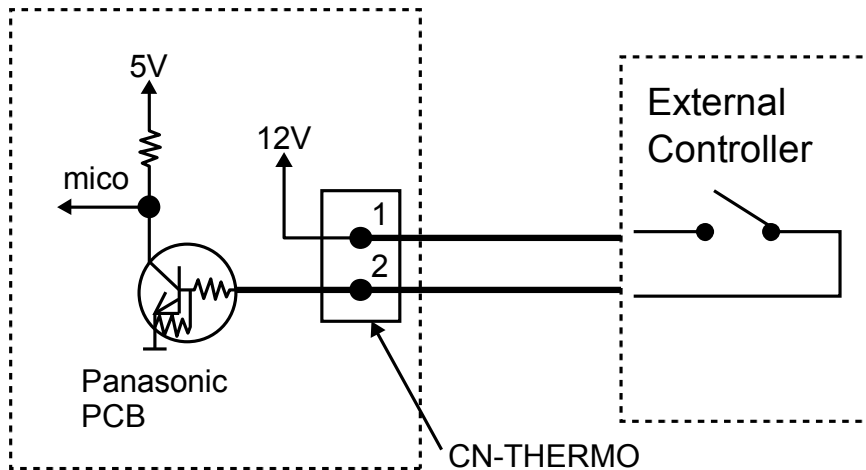

- Maximum length of communication cable is 20 meter.
- Control content:

External Control Switch	Control Panel OFF/ON	Control Panel Power LED	System Status
ON	ON	ON	ON
ON	OFF	OFF	OFF
OFF	ON	ON	OFF
OFF	OFF	OFF	OFF

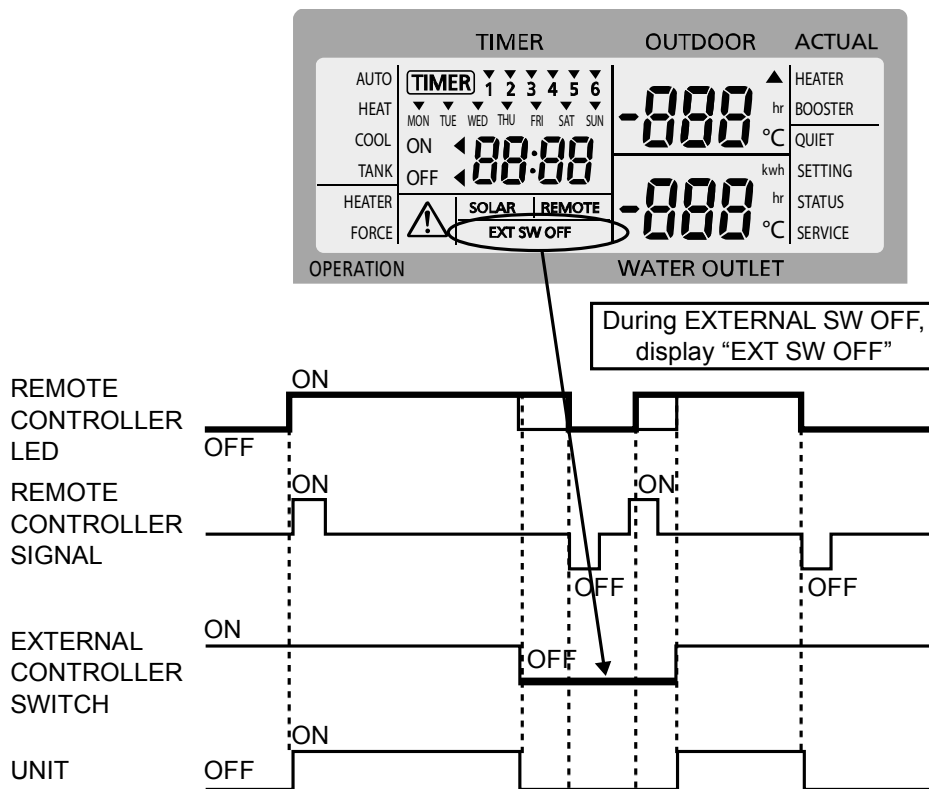

\* During External Switch OFF condition, it is allow to change the setting and also timer operation.

### **13.19 Holiday Mode**

- Purpose:  
Promotes energy saving by allowing the user to stop the system during holiday and enables the system to resume at the preset temperature after holiday.
- Control details:
  - Range of days can be set in holiday mode is from 1 to 999 days.
  - After days of holiday have been set, heat pump will stop and only resume operation at 12.00am at the end of holiday countdown.
- Start condition:
  - Unit is OFF and holiday mode is set.
    - \* The day the holiday mode was set is counted as day 1.
- Stop condition:
  - OFF/ON button is pressed.
  - Holiday counter is reached.

### **13.20 Dry Concrete Function**

- Purpose  
Provide heat to floor heating panel and dry the wet concrete during installation.
- Setting condition:
  - Dry concrete parameter can be set through control panel by selecting dry concrete menu.
  - Parameters are possible to set up to 99 days with different target set temperature.
- Control details:
  - Dry concrete operation can be activate under Service Mode 3.
  - Once dry concrete function start, day 1 setting temperature will be send to indoor unit by control panel.
  - Unit will operate heat mode with dry concrete preset water outlet temperature. (No shift value added to the preset water outlet temperature)
  - After complete day 1 setup operation, day 2 data will be send to indoor at 12.00am on the second day.
  - Each preset data will be send everyday until dry concrete mode is complete, unit will turns OFF and exit dry concrete function.
  - 3 ways valve and booster heater will turn OFF and 2 ways valve will turns ON.
- Cancel condition:
  - Unit will turns OFF and exit dry concrete function.
  - OFF signal is received by pressing OFF/ON button or error H76 is occurred.

## 14. Protection Control

### 14.1 Protection Control for All Operations

#### 14.1.1 Time Delay Safety Control

- 1 The compressor will not start for three minutes after stop of operation.

#### 14.1.2 30 Seconds Forced Operation

- 1 Once the compressor starts operation, it will not stop its operation for 30 seconds.
- 2 However, it can be stopped using control panel at indoor unit.

#### 14.1.3 Total Running Current Control

- 1 When the outdoor running current exceeds X value, the compressor frequency will decrease.
- 2 If the outdoor running current does not exceed X value, the compressor frequency will return to normal operating frequency.
- 3 If the outdoor running current continue to increase till exceed Y value, compressor will stop, and if this occurs 3 times within 20 minutes, system will stop operation and OFF/ON control panel LED will blink (F16 error occurs).

Operation Mode	UD09FE8		UD12FE8		UD14FE8		UD16FE8	
	X (A)	Y (A)	X (A)	Y (A)	X (A)	Y (A)	X (A)	Y (A)
Heating	6.21	10.60	7.35	10.60	7.99	10.60	8.53	10.60
Cooling	6.21	10.60	6.51	10.60	7.89	10.60	8.43	10.60

#### A. DC Peak Current Control

- 1 When the current to IPM exceeds set value of 34 A, compressor will stop. Compressor will restart after three minutes.
- 2 If the set value exceeds again for more than 30 seconds after the compressor restarts, operation will restart after two minutes.
- 3 If the set value exceeds again for within 30 seconds after the compressor restarts, operation will restart after one minute. If this condition repeats continuously for seven times, system will stop operation and OFF/ON control panel LED will blink (F23 error occurs).

#### 14.1.4 Compressor Overheating Prevention Control

- The compressor operating frequency is regulated in accordance to compressor tank temperature as shown in below figures. When the compressor tank temperature exceeds 107°C, compressor will stop, and if this occurs 4 times within 30 minutes, system will stop operation and OFF/ON control panel LED will blink (F20 error occurs).

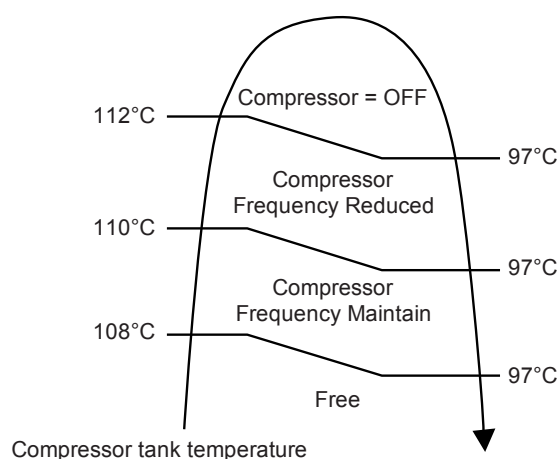

#### 14.1.5 Low Frequency Protection Control 1

- When the compressor continuously operates at frequency lower than 21 Hz for 240 minutes, the operation frequency will change to 20 Hz for 2 minutes.

### 14.1.6 Low Frequency Protection Control 2

- When all the below conditions comply, the minimum compressor frequency will change to lower frequency.

Temperature, T, for:	Heating	Cooling
Outlet water (°C)	T < 14 or T ≥ 48	T < 14 or T ≥ 30
Outdoor air (°C)	T < 4 or T ≥ 24	T < 13 or T ≥ 38
Indoor heat exchanger (°C)	T ≥ 0	T < 30

### 14.1.7 High Pressure Sensor Control

- Purpose:
  - To protect the system operation.
- Detection period:
  - After compressor on for 1 minute.
- Detection conditions:
  - When abnormal high voltage detection, 5 V or when open circuit detection 0V for 5 seconds continuously.
- After detection:
  - When abnormality is detected 4 times within 120 minutes, unit stop operation.
  - OFF/ON control panel LED will blink (H64 error occurs).

### 14.1.8 Outside Temperature Current Control

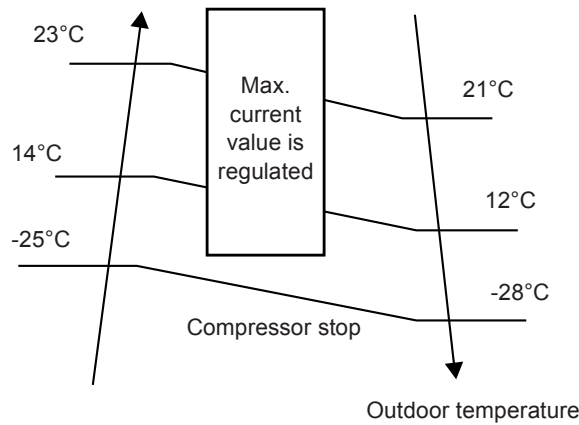

### 14.1.9 Crank Case Heater Control

- Purpose:
  - For compressor protection during low outdoor ambient operation (during heating low temperature operation).
- Control content:
  - Trigger heater START condition
    - When the outdoor air temperature is below than 5°C, and discharge temperature is 11°C or below.
  - Resetting heater STOP condition
    - When the outdoor air temperature exceeds entry condition (2°C)
    - When the discharge temperature exceeds entry condition (5°C)

## 14.2 Heat Exchanger (HEX) Protection Control

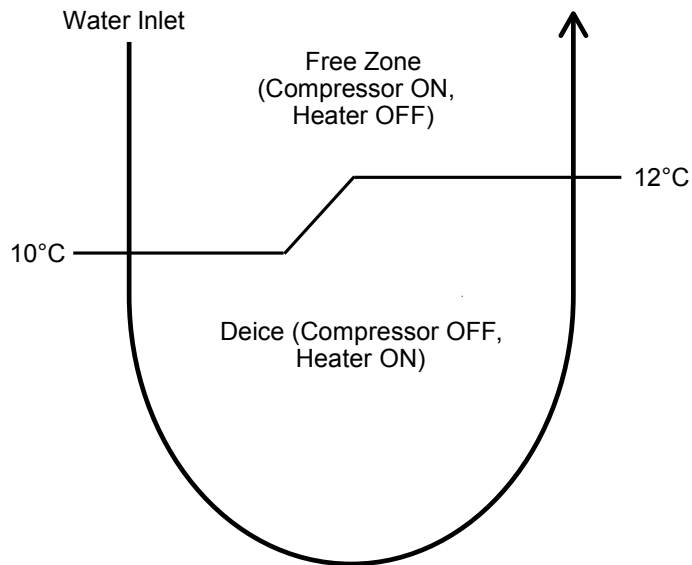

- Start Condition:
  - When outdoor ambient temperature is less than 10°C.
- Control Details:
  - Heater will turn ON and heat pump turn OFF when water inlet temperature below 10°C.
  - Heater will turn OFF and heat pump turn ON when water inlet temperature increase more than 12°C.
- End Condition:
  - When outdoor ambient temperature is more than 13°C.

However this control will take place 29 minutes after compressor restart.



## 14.3 Protection Control for Heating Operation

### 14.3.1 Outdoor Air Temperature Control

The maximum current value is regulated when the outdoor air temperature rises above 14°C in order to avoid compressor overloading.

### 14.3.2 Deice Operation

When outdoor pipe temperature and outdoor air temperature is low, deice operation start where outdoor fan motor stop.

- Deice judging condition

Outdoor Unit Deice Control

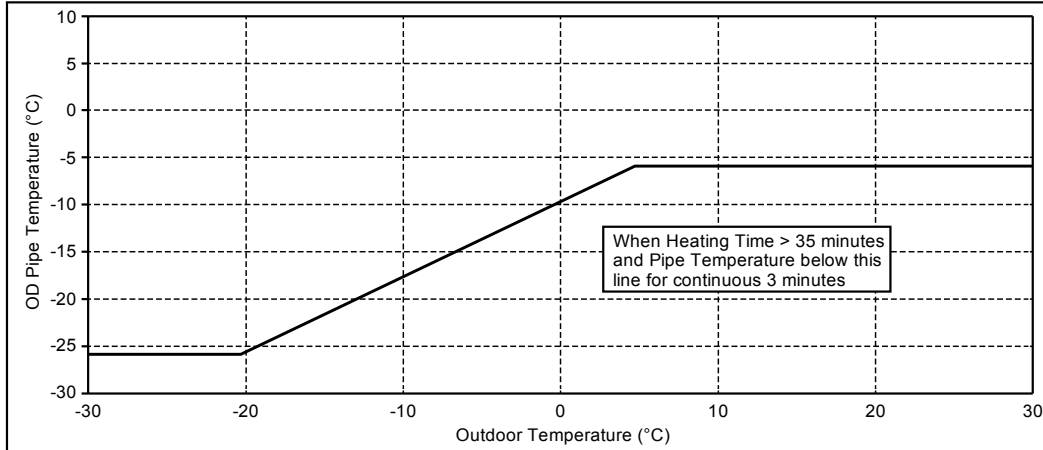

#### Deice start depends:

1. Outdoor air sensor temp.
2. Outdoor pipe sensor temp.
3. Heating accumulation time

- Deice mode selection condition
  - There are 2 deice modes, according to water inlet temperature and outdoor ambient temperature the deice mode is decided.

Water inlet temperature

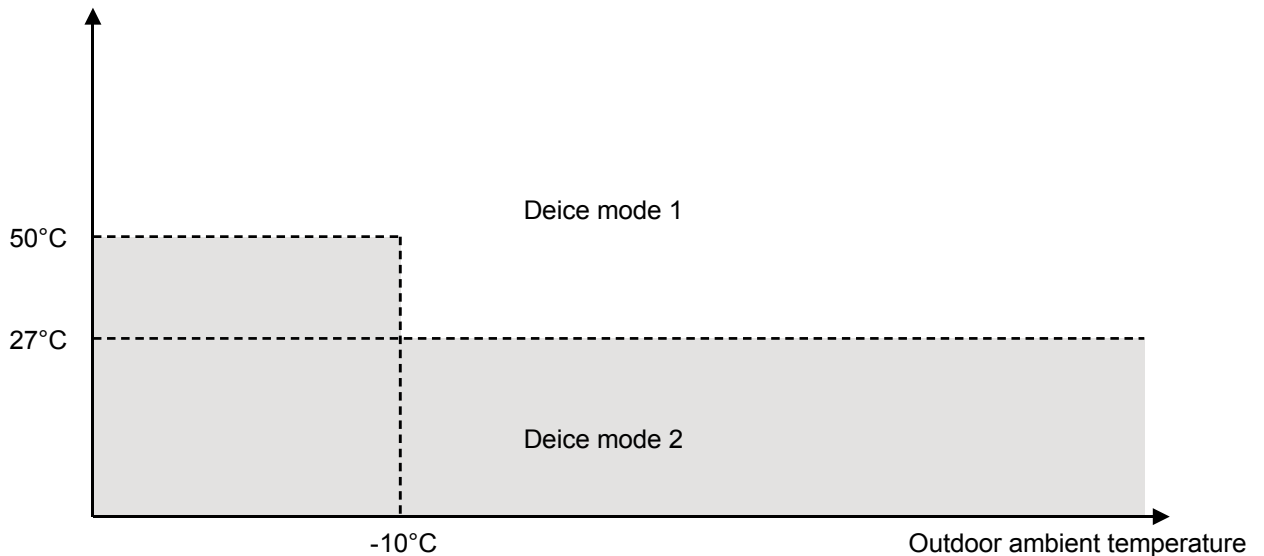

Judgement details:

- 1) When water inlet temperature is more than 50°C, unit will operate deice mode 1.
- 2) When water inlet temperature is less than 27°C, unit will operate deice mode 2.
- 3) When water inlet temperature is less than 50°C and outdoor ambient temperature is less than -10°C, unit will operate deice mode 2.
- 4) When water outlet temperature sensor 2 detect temperature is less than 22°C, unit will operate deice mode 2.

- Deice operation time diagram

a. Deice mode 1 control:

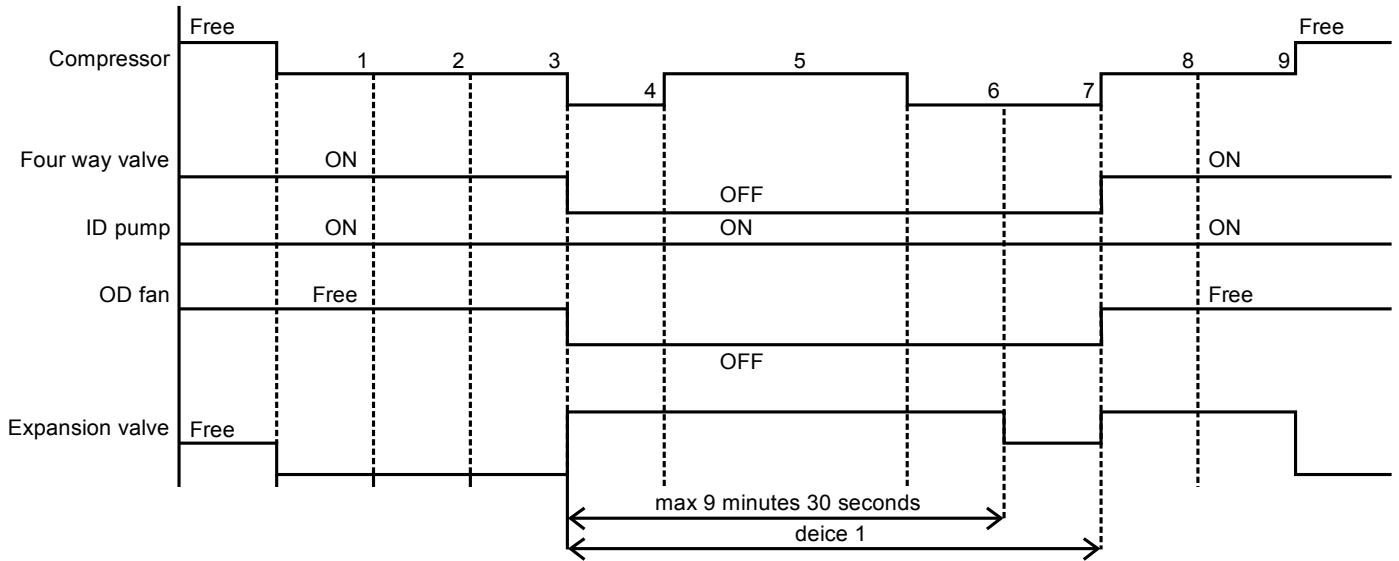

b. Deice mode 2 control:

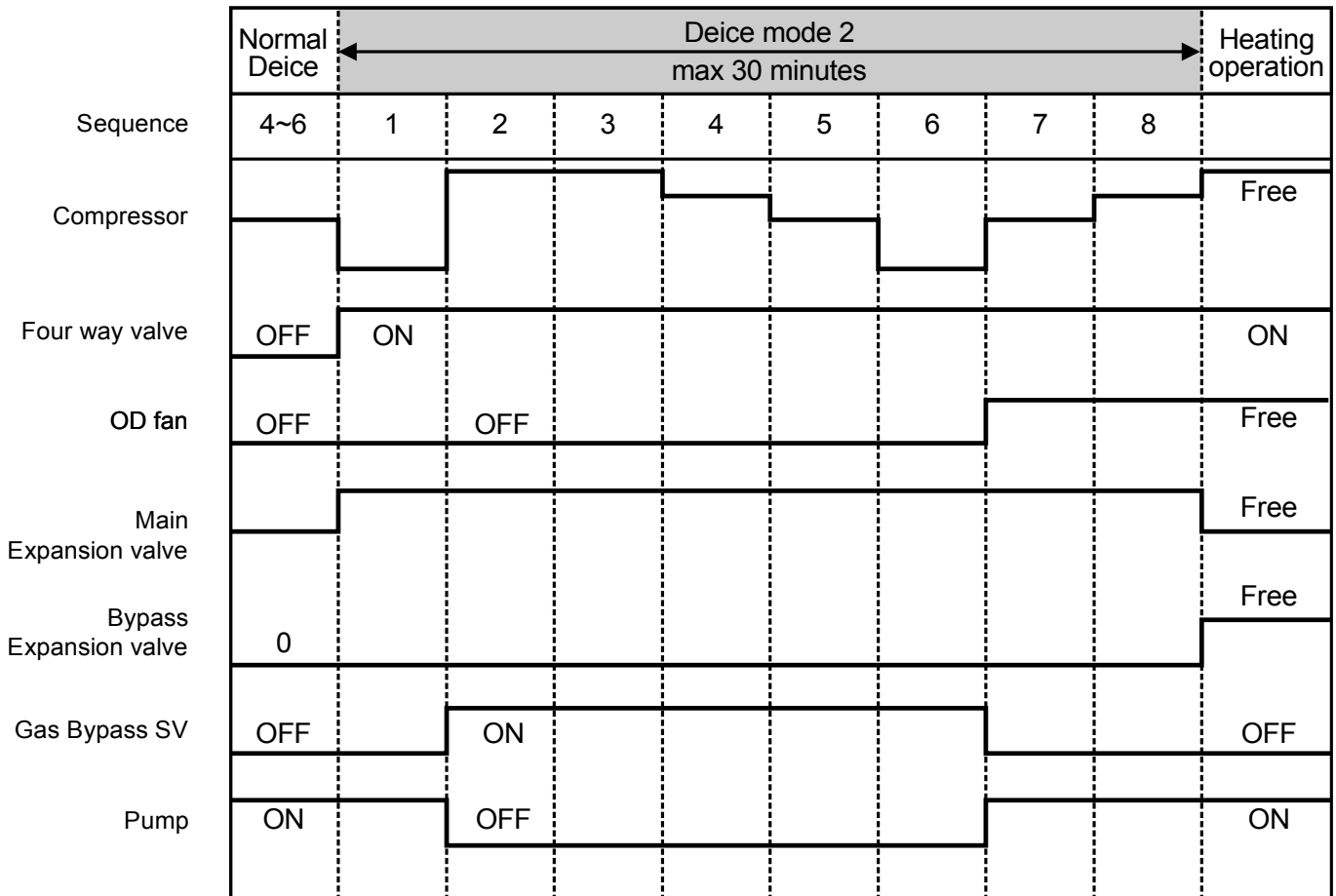

## 14.4 Protection Control for Cooling Operation

### 14.4.1 Outdoor Air Temperature Control

- The Compressor operating frequency is regulated in accordance to the outdoor air temperature as shown in the diagram below.
- This control will begin 1 minute after the compressor starts.
- Compressor frequency will adjust base on outdoor air temperature.

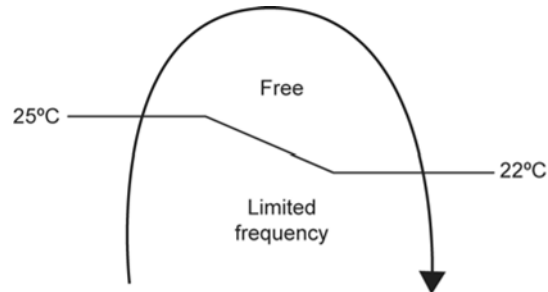

### 14.4.2 Freeze Prevention Control 1

- 1 When indoor heat exchanger temperature is lower than 0°C continuously for 10 seconds, compressor will stop operating.
- 2 Compressor will resume its operation three minutes after the indoor heat exchanger is higher than 1°C.
- 3 Indoor heat exchanger freeze prevention (H99) will memory in error history.

## 15. Servicing Guide

### 15.1 How to Take Out Front Plate

Please follow the steps below for take out front plate. Before removing the front plate of indoor unit, always switch off all power supply (i.e. indoor unit power supply, heater power supply and tank unit power supply).

- 1 Remove the 2 mounting screws which located at bottom of the front plate and 1 mounting screw at the front of the plate.
- 2 Gently pull the lower section of the front plate towards you to remove the front plate from left and right hooks.
- 3 Hold the left edge and right edge of front plate to lift up front plate from hooks.

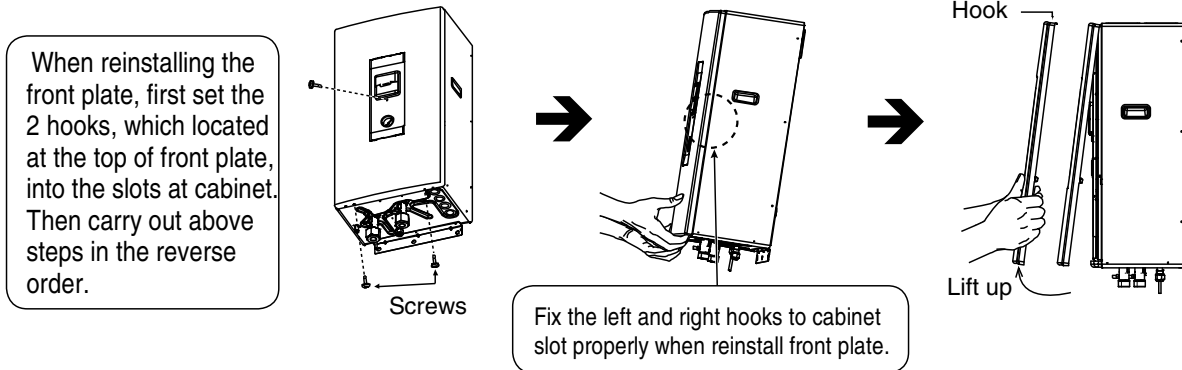

### 15.2 How to Take Out Side Cabinet

Please follow the steps below to remove the side cabinet. Before removing the front plate of indoor unit always switch off all power supply (i.e. indoor power supply, heater power supply and tank unit power supply).

- 1 Perform the steps in HOW TO TAKE OUT FRONT PLATE.
- 2 Remove all the 13 mounting screws on the left, right and top of the side cabinet.
- 3 Gently remove the side cabinet by holding both of the handles.

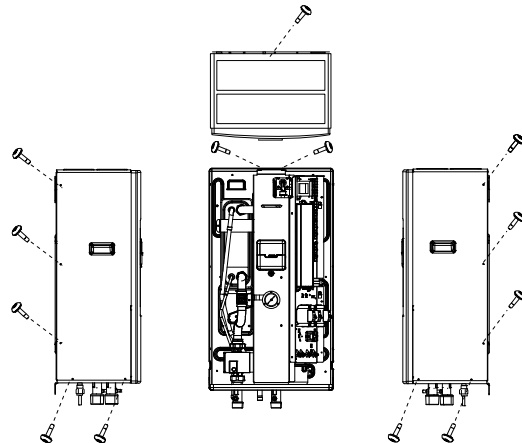

### 15.3 Test Run

- 1 Fill up the boiler tank with water. For details refer to boiler tanks installation instruction and operation instruction.
- 2 Set ON to the indoor unit and RCCB/ELCB. Then, for control panel's operation please refers to air-to-water heatpump's operation instruction.
- 3 For normal operation, pressure gauge reading should be in between 0.05 MPa and 0.3 MPa. If necessary, adjust the water pump speed accordingly to obtain normal water pressure operating range. If adjust water pump speed cannot solve the problem, contact your local authorized dealer.
- 4 After test run, please clean the external filter. Reinstall it after finish cleaning.

### 15.4 Proper Pump Down Procedure [SERVICE MODE: 01]

#### ⚠ WARNING

Strictly follow the steps below for proper pump down procedure. Explosion may occur if the steps are not followed as per sequence.

- 1 When the heatpump unit is not in operation (standby), press the "SERVICE" switch on control panel to enter SERVICE mode. Operate the system in Sr : 01 mode for pump down operation.
- 2 After 10 ~ 15 minutes, (after 1 or 2 minutes in case very low ambient temperatures (< 10°C)), fully close 2 way valve.
- 3 After 3 minutes, fully close 3 way valve.
- 4 Press the "OFF/ON" switch on control panel to stop pump down operation.
- 5 Remove the refrigerant piping.

## 15.5 How to Adjust Water Flow Rate [SERVICE MODE: 02]

Before adjust the water flow rate, make sure that the total water volume in the installation is 50 litres minimum for heating side. The default setting is SPEED 3 (Only for WH-S\*\*09\*3E8 and WH-S\*\*09/12\*9E8) and SPEED 4 for WH-S\*\*14/16\*9E8. Please ensure the minimum flow rate is not less than 13 l/min and not more than 50 l/min.

The available external static pressure (kPa) in function of the water flow rate (l/min) is shown in the P-Q graph. Depend on the hydraulic system pressure loss and type, the water flow rate can be adjusted by control panel.

1. Press SERVICE button for 5 seconds.
2. Press ▲ button to enter menu S02 and press SET button.
3. Press SELECT button then press ▲/▼ button to change SPEED and press SET to confirm.
4. Press OFF/ON button to quit setting.

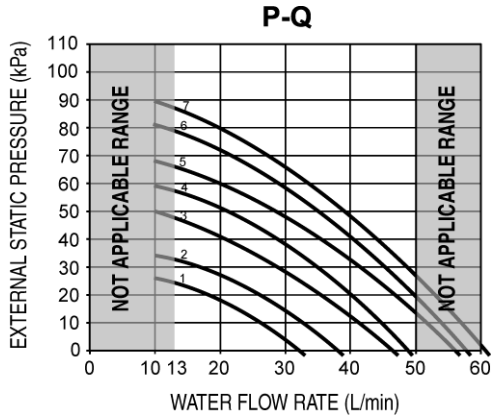

(WH-SDC9F3E8 WH-SDC12F9E8)

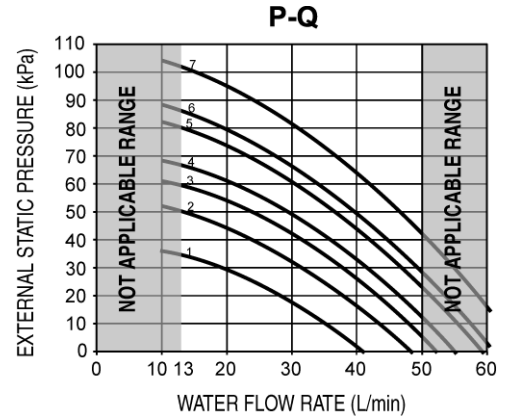

(WH-SDC14/16F9E8)

## 15.6 Expansion Vessel Pre Pressure Checking

- Expansion Vessel with 10 L air capacity and initial pressure of 1 bar is installed in this indoor unit.
- Total amount of water in system should be below 200 L.  
(Note: This amount of water is not include the tank unit volume)
- If total amount of water is over 200 L, please add expansion vessel.
- Please keep the installation height difference of system water circuit within 10 m.  
(Inner volume of same indoor unit is about 5 L)

## 15.7 How to Unlock Cool Mode

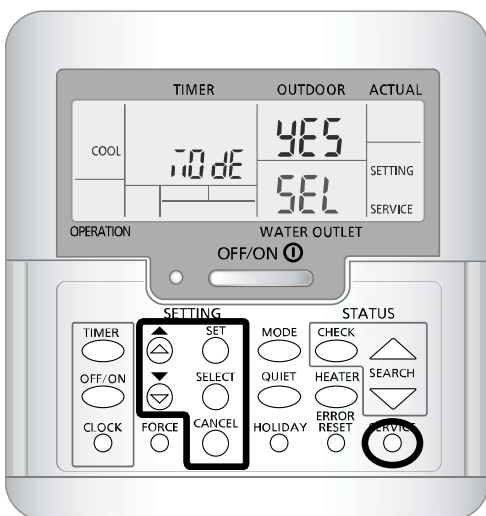

1. Press buttons SET and SERVICE for 5 seconds.
2. Press SELECT button.
3. Unlock COOL mode with ▲/▼.
4. Press SET button.

## 15.8 Dry Concrete [SERVICE MODE: 03]

- If Dry Concrete has been set, Dry Concrete status can be activated and monitored by following procedure.
  - 1 Press SERVICE button for 5 seconds.
  - 2 Press ▲ to enter menu Sr: 03 and press SET button to activate Dry Concrete function.
  - 3 Press OFF/ON button to quit setting.

## 15.9 EEPROM Factory Default Data Setup Procedure

- 1 This process should be done at Gemstar (and/or) PAPAMY as the last process after any inspection.
- 2 This condition should be activated by pressing combination of few SW's for certain time as shown.

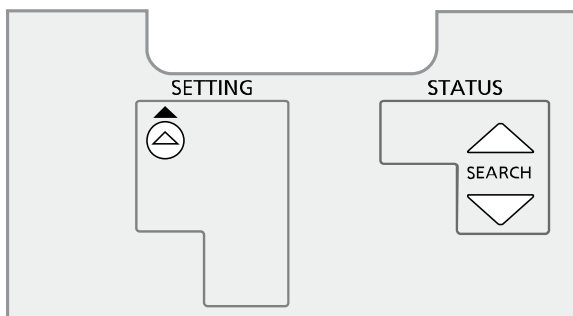

These 3 SW's should press continuously for 5secs.  
(Operation should be OFF during this period)

- 3 When this condition is activated, default data should be written in EEPROM.
- 4 Once the default data is written in the EEPROM, the following full LCD display should be ON for 2secs for confirmation. After 2secs, it goes back to normal display.

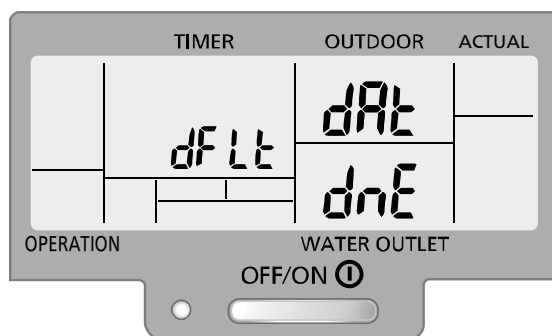

## 16. Maintenance Guide

In order to ensure optimal performance of the unit, checks and inspections on the unit and the field wiring must be carried out regularly.

Before carried out any maintenance or repair work, and removing the front plate of heat exchanger unit, always switch off all power supply (i.e. indoor unit power supply, heater power supply and sanitary tank power supply). Below checks must be carried out at least once a year.

### 1 Water pressure

Water pressure should not lower than 0.05 MPa (with inspects the pressure gauge). If necessary add tap water into boiler tank. Refer to boiler tank installation instruction for details on how to add water.

### 2 Pressure relief valve

- Check for correction operation of pressure relief valve by turn up the lever to become horizontal. (Refer to figure below)
- If you do not hear a clacking sound (due to water drainage), contact your local authorized dealer.
- Turn down the lever after checking finish.
- In case the water keeps drained out from the unit, switch off the system, and then contact your local authorized dealer.

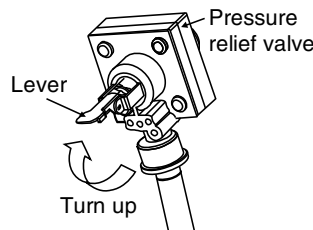

How to check pressure relief valve

### 3 Air purge valve

Air purge valve must be installed at all high points in a closed water circuit system.

An automatic air purge valve is provided inside the indoor unit. To automatically purge the air from the system, turn the plug on the air outlet anticlockwise by one complete turn from fully closed position. Excessive air is automatically purged if the plug is kept in this position.

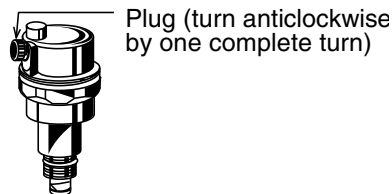

Air purge valve

### 4 Indoor unit control board area

Thorough visual inspection of the control board and look for defects, i.e. loose connection, melting of wire insulator and etc.

### 5 RCCB/ELCB

Ensure the RCCB/ELCB set to "ON" condition before check RCCB/ELCB.

Turn on the power supply to the indoor unit.

This testing could only be done when power is supplied to the indoor unit.



#### WARNING

Be careful not to touch parts other than RCCB/ELCB test button when the power is supplied to Indoor Unit. Else, electrical shock may happen.

- Push the "TEST" button on the RCCB/ELCB. The lever would turn down and indicate "0" and indicate green colour if it functions normal.
- Contact authorized dealer if the RCCB/ELCB malfunction.
- Turn off the power supply to the indoor unit.
- If RCCB/ELCB functions normal, set the lever to "ON" again after testing finish.

6 Reset overload protector

Overload protector serves the safety purpose to prevent the water over heating. When the overload protector trip at high water temperature, take below steps to reset it.

- a. Take out OLP cover.
- b. Use a test pen to push the centre button gently in order to reset the Overload protector.
- c. After finish, install back the Overload protector following the reverse order of step a & b.

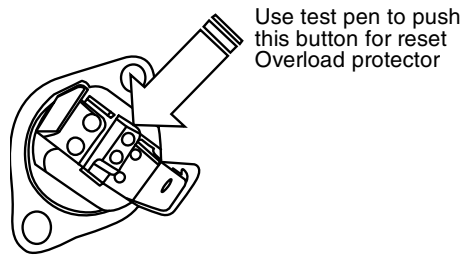

How to reset Overload protector

7 External water filter (field supply)

Clean the external water filter in regularly basic.

- o External water filter is located inside the tube connector which is before water inlet connector of indoor unit (indicated with "WATER IN"). (Refer to figure below)
- o Use spanner to detach the tube connector nut.
- o Take out the filter carefully so that not deforms it shape.
- o Use tap water only to wash the residue on the filter. If necessary, gently use soft brush only to clean the hard dirt.
- o After clean, put it back to the original location and tighten the nut connection with torque wrench.

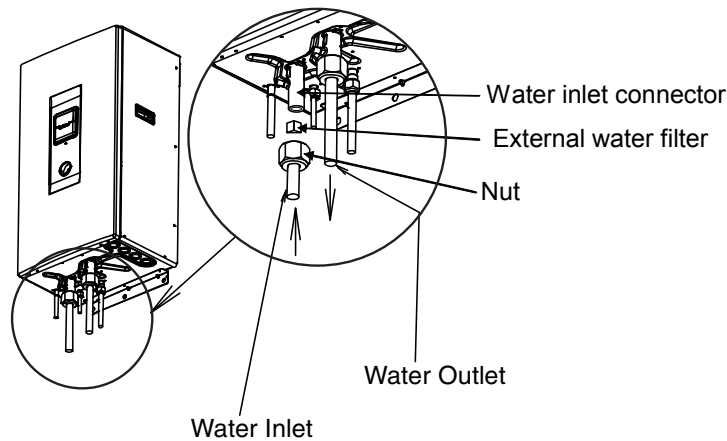

Location of external water filter

8 How to service overload protector

Perform the steps in "How to Take Out Side Cabinet" before performing the steps below.

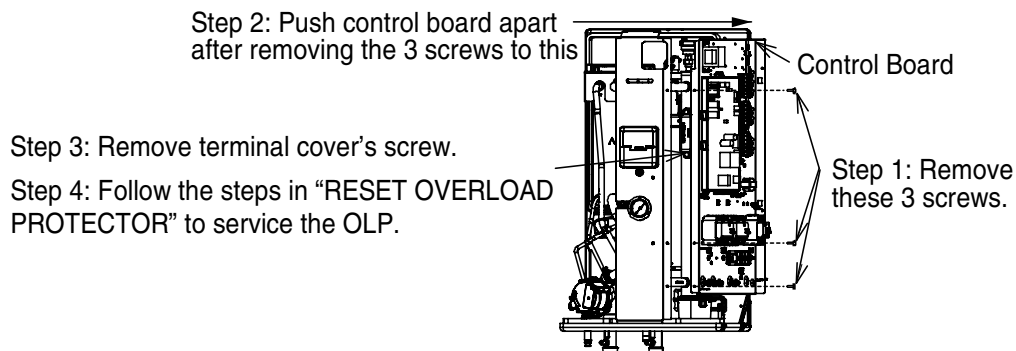



# 17. Troubleshooting Guide

## 17.1 Refrigeration Cycle System

In order to diagnose malfunctions, make sure that there are no electrical problems before inspecting the refrigeration cycle.

Such problems include insufficient insulation, problem with the power source, malfunction of a compressor and a fan.

The normal pressure of the refrigeration cycle depends on various conditions, the standard values for them are shown in the table on the right.

Normal Pressure (Standard)

	Gas pressure MPa (kg/cm <sup>2</sup> G)
Heating Mode	2.3 ~ 2.9 (23 ~ 29)
Cooling Mode	0.9 ~ 1.2 (9 ~ 12)

- ★ Condition:
- Outdoor temperature 7°C at heating mode and 35°C at cooling mode.
  - Compressor operates at rated frequency.

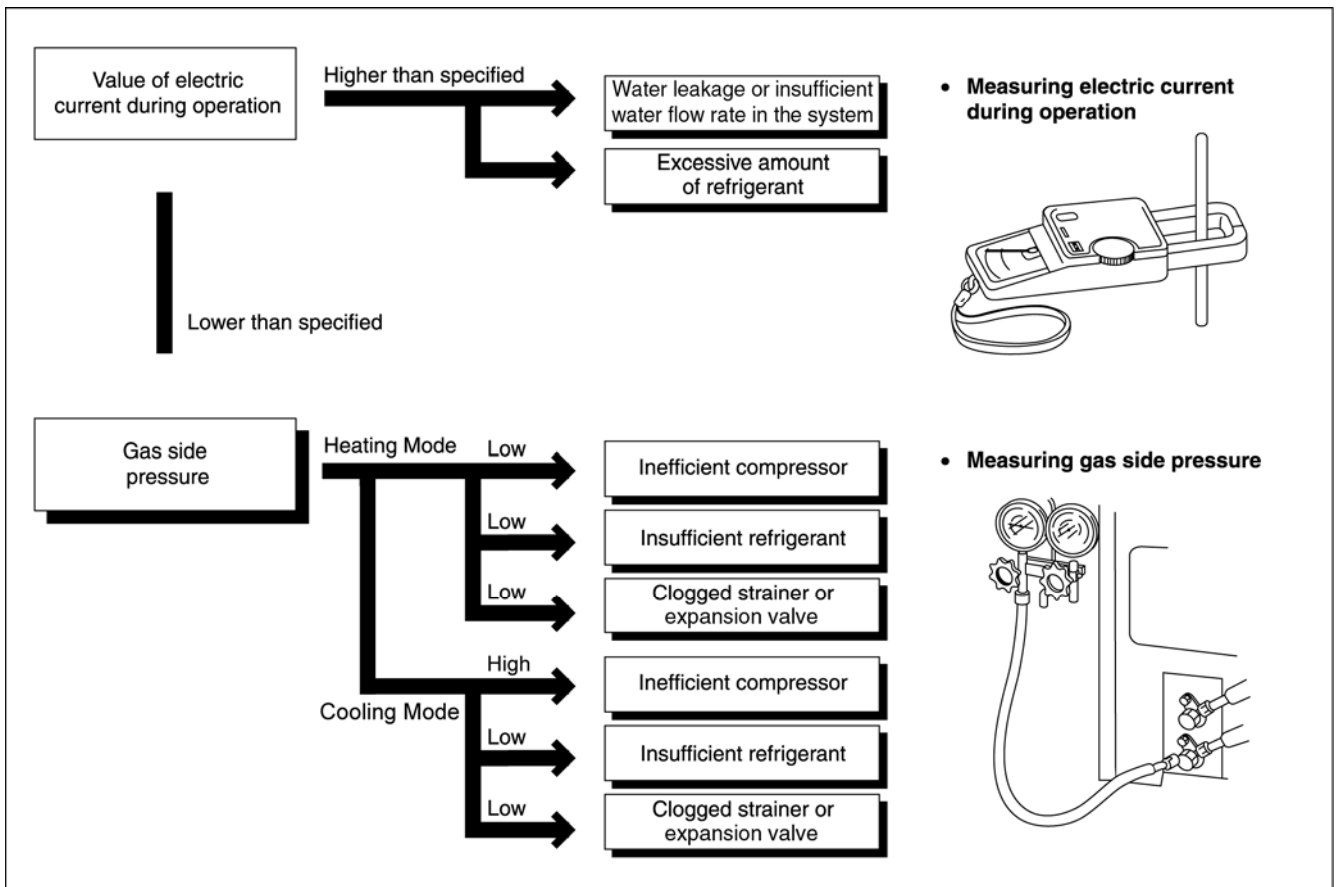

- **Measuring electric current during operation**

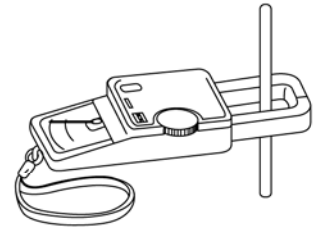

- **Measuring gas side pressure**

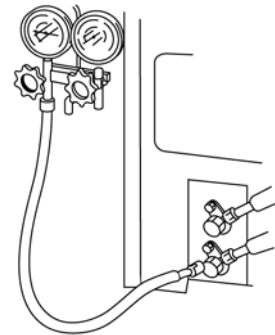

## 17.2 Relationship between the Condition of the Air-to-Water Heatpump Indoor and Outdoor Units and Pressure and Electric Current

Condition of the Air-to-Water Heatpump indoor and outdoor units	Heating Mode			Cooling Mode		
	Low Pressure	High Pressure	Electric current during operation	Low Pressure	High Pressure	Electric current during operation
Water leakage or insufficient water flow rate in the system						
Excessive amount of refrigerant						
Inefficient compression						
Insufficient refrigerant (gas leakage)						
Outdoor heat exchange deficiency						
Clogged expansion valve or Strainer						

- Carry out the measurements of pressure, electric current, and temperature fifteen minutes after an operation is started.

## 17.3 Breakdown Self Diagnosis Function

### 17.3.1 Self Diagnosis Function (Three Digits Alphanumeric Code)

- When abnormality occur during operation, the system will stop operation, and OFF/ON control panel LED will blink and error code will display on the control panel Timer display LCD.
- Even error code is reset by turning OFF power supply or by pressing ERROR RESET button, if the system abnormality is still un-repaired, system will again stop operation, and OFF/ON control panel LED will again blink.
- The error code will store in IC memory.
- **To check the error code**
  - 1 When an abnormality occurs, system will stop operation and OFF/ON control panel LED will blink.
  - 2 Error code of the abnormality will display on the control panel Timer display LCD.
  - 3 To determine the abnormality description, the error code table needs to be referred.
- **To display past/last error code**
  - 1 Turn ON power supply.
  - 2 Press and hold the CHECK button for more than 5 seconds to enter status mode.
  - 3 Press the SEARCH DOWN/UP button to retrieve past/last error code.
  - 4 Press the CANCEL button or wait 30 seconds to exit status mode.
- **To permanently delete error code from IC memory**
  - 1 Turn ON power supply.
  - 2 Press and hold the ERROR RESET button for more than 8 seconds till a beep sound is heard.

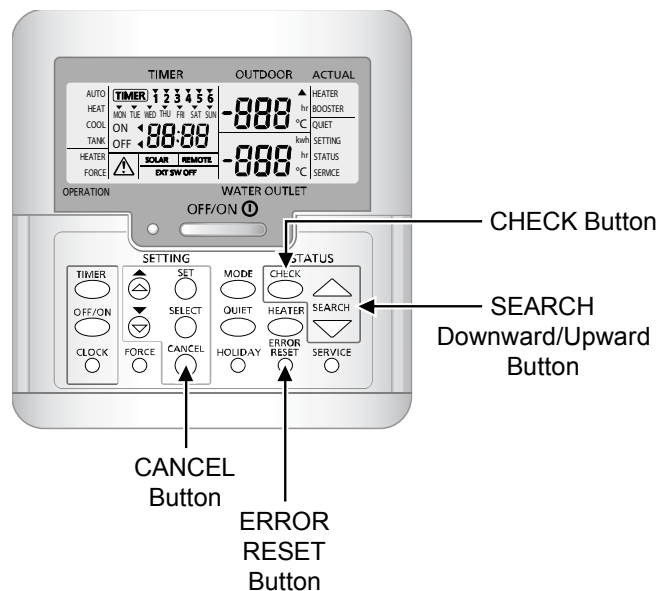

## 17.4 Error Codes Table

Diagnosis display	Abnormality/Protection control	Abnormality judgement	Primary location to verify
H00	No abnormality detected	—	—
H12	Indoor/Outdoor capacity unmatched	90s after power supply	<ul style="list-style-type: none"> <li>Indoor/outdoor connection wire</li> <li>Indoor/outdoor PCB</li> <li>Specification and combination table in catalogue</li> </ul>
H15	Outdoor compressor temperature sensor abnormality	Continue for 5 sec.	<ul style="list-style-type: none"> <li>Compressor temperature sensor (defective or disconnected)</li> </ul>
H20	Water pump abnormality	Continue for 10 sec.	<ul style="list-style-type: none"> <li>Indoor PCB</li> <li>Water pump (malfunction)</li> </ul>
H23	Indoor refrigerant liquid temperature sensor abnormality	Continue for 5 sec.	<ul style="list-style-type: none"> <li>Refrigerant liquid temperature sensor (defective or disconnected)</li> </ul>
H27	Service valve error	Continue for 5 minutes	<ul style="list-style-type: none"> <li>High pressure sensor (defective or disconnected)</li> </ul>
H42	Compressor low pressure abnormality	—	<ul style="list-style-type: none"> <li>Outdoor pipe temperature sensor</li> <li>Clogged expansion valve or strainer</li> <li>Insufficient refrigerant</li> <li>Outdoor PCB</li> <li>Compressor</li> </ul>
H62	Water flow switch abnormality	Continue for 1 min.	<ul style="list-style-type: none"> <li>Water flow switch</li> </ul>
H64	Refrigerant high pressure abnormality	Continue for 5 sec.	<ul style="list-style-type: none"> <li>Outdoor high pressure sensor (defective or disconnected)</li> </ul>
H65	Deice circulation error	Continue for 10 sec.	<ul style="list-style-type: none"> <li>Water flow switch sensor (defective or disconnected)</li> <li>Water pump malfunction</li> <li>Buffer tank (is used)</li> </ul>
H70	Back-up heater OLP abnormality	Continue for 60 sec.	<ul style="list-style-type: none"> <li>Back-up heater OLP (Disconnection or activated)</li> </ul>
H72	Tank sensor abnormal	Continue for 5 sec.	<ul style="list-style-type: none"> <li>Tank sensor</li> </ul>
H76	Indoor - control panel communication abnormality	—	<ul style="list-style-type: none"> <li>Indoor - control panel (defective or disconnected)</li> </ul>
H90	Indoor/outdoor abnormal communication	> 1 min after starting operation	<ul style="list-style-type: none"> <li>Internal/external cable connections</li> <li>Indoor/Outdoor PCB</li> </ul>
H91	Tank heater OLP abnormality	Continue for 60 sec.	<ul style="list-style-type: none"> <li>Tank heater OLP (Disconnection or activated)</li> </ul>
H95	Indoor/Outdoor wrong connection	—	<ul style="list-style-type: none"> <li>Indoor/Outdoor supply voltage</li> </ul>
H98	Outdoor high pressure overload protection	—	<ul style="list-style-type: none"> <li>Outdoor high pressure sensor</li> <li>Water pump or water leakage</li> <li>Clogged expansion valve or strainer</li> <li>Excess refrigerant</li> <li>Outdoor PCB</li> </ul>
H99	Indoor heat exchanger freeze prevention	—	<ul style="list-style-type: none"> <li>Indoor heat exchanger</li> <li>Refrigerant shortage</li> </ul>
F12	Pressure switch activate	4 times occurrence within 20 minutes	<ul style="list-style-type: none"> <li>Pressure switch</li> </ul>
F14	Outdoor compressor abnormal revolution	4 times occurrence within 20 minutes	<ul style="list-style-type: none"> <li>Outdoor compressor</li> </ul>
F15	Outdoor fan motor lock abnormality	2 times occurrence within 30 minutes	<ul style="list-style-type: none"> <li>Outdoor PCB</li> <li>Outdoor fan motor</li> </ul>
F16	Total running current protection	3 times occurrence within 20 minutes	<ul style="list-style-type: none"> <li>Excess refrigerant</li> <li>Outdoor PCB</li> </ul>
F20	Outdoor compressor overheating protection	4 times occurrence within 30 minutes	<ul style="list-style-type: none"> <li>Compressor tank temperature sensor</li> <li>Clogged expansion valve or strainer</li> <li>Insufficient refrigerant</li> <li>Outdoor PCB</li> <li>Compressor</li> </ul>
F22	IPM (power transistor) overheating protection	3 times occurrence within 30 minutes	<ul style="list-style-type: none"> <li>Improper heat exchange</li> <li>IPM (Power transistor)</li> </ul>
F23	Outdoor Direct Current (DC) peak detection	7 times occurrence continuously	<ul style="list-style-type: none"> <li>Outdoor PCB</li> <li>Compressor</li> </ul>
F24	Refrigeration cycle abnormality	2 times occurrence within 20 minutes	<ul style="list-style-type: none"> <li>Insufficient refrigerant</li> <li>Outdoor PCB</li> <li>Compressor low compression</li> </ul>
F25	Cooling/Heating cycle changeover abnormality	4 times occurrence within 30 minutes	<ul style="list-style-type: none"> <li>4-way valve</li> <li>V-coil</li> </ul>
F27	Pressure switch abnormality	Continue for 1 min.	<ul style="list-style-type: none"> <li>Pressure switch</li> </ul>
F30	Water outlet sensor 2 abnormality	Continue for 5 sec.	<ul style="list-style-type: none"> <li>Water outlet sensor 2 (defective or disconnected)</li> </ul>

Diagnosis display	Abnormality/Protection control	Abnormality judgement	Primary location to verify
F36	Outdoor air temperature sensor abnormality	Continue for 5 sec.	<ul style="list-style-type: none"> <li>Outdoor air temperature sensor (defective or disconnected)</li> </ul>
F37	Indoor water inlet temperature sensor abnormality	Continue for 5 sec.	<ul style="list-style-type: none"> <li>Water inlet temperature sensor (defective or disconnected)</li> </ul>
F40	Outdoor discharge pipe temperature sensor abnormality	Continue for 5 sec.	<ul style="list-style-type: none"> <li>Outdoor discharge pipe temperature sensor (defective or disconnected)</li> </ul>
F41	PFC control	4 times occurrence within 10 minutes	<ul style="list-style-type: none"> <li>Voltage at PFC</li> </ul>
F42	Outdoor heat exchanger temperature sensor abnormality	Continue for 5 sec.	<ul style="list-style-type: none"> <li>Outdoor heat exchanger temperature sensor (defective or disconnected)</li> </ul>
F43	Outdoor defrost sensor abnormality	Continue for 5 sec.	<ul style="list-style-type: none"> <li>Outdoor defrost sensor (defective or disconnected)</li> </ul>
F45	Indoor water outlet temperature sensor abnormality	Continue for 5 sec.	<ul style="list-style-type: none"> <li>Water outlet temperature sensor (defective or disconnected)</li> </ul>
F46	Outdoor Current Transformer open circuit	—	<ul style="list-style-type: none"> <li>Insufficient refrigerant</li> <li>Outdoor PCB</li> <li>Compressor low</li> </ul>
F48	Outdoor EVA outlet temperature sensor abnormality	Continue for 5 sec.	<ul style="list-style-type: none"> <li>Outdoor EVA outlet temperature sensor (defective or disconnected)</li> </ul>
F49	Outdoor bypass outlet temperature sensor abnormality	Continue for 5 sec.	<ul style="list-style-type: none"> <li>Outdoor bypass outlet temperature sensor (defective or disconnected)</li> </ul>
F95	Cooling high pressure overload protection	—	<ul style="list-style-type: none"> <li>Outdoor high pressure sensor</li> <li>Water pump or water leakage</li> <li>Clogged expansion valve or strainer</li> <li>Excess refrigerant</li> <li>Outdoor PCB</li> </ul>

## 17.5 Self-diagnosis Method

### 17.5.1 Connection Capability Rank Abnormality (H12)

#### Malfunction Decision Conditions:

During startup operation of cooling and heating, the capability rank of indoor checked by the outdoor is used to determine connection capability rank abnormality.

#### Malfunction Caused:

- 1 Wrong model interconnected.
- 2 Wrong indoor unit or outdoor unit PCB (main) used.
- 3 Faulty indoor unit or outdoor unit PCB (main).

#### Abnormality Judgment:

Continue for 90 seconds.

#### Troubleshooting:

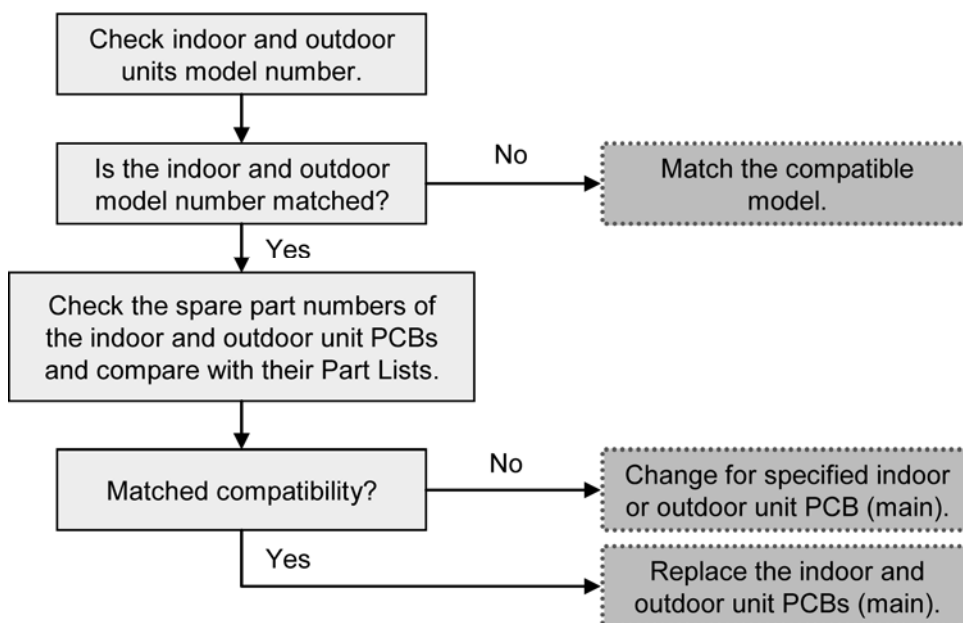

## 17.5.2 Compressor Tank Temperature Sensor Abnormality (H15)

### Malfunction Decision Conditions:

During startup and operation of cooling and heating, the temperatures detected by the compressor tank temperature sensor are used to determine sensor error.

### Malfunction Caused:

- 1 Faulty connector connection.
- 2 Faulty sensor.
- 3 Faulty outdoor unit PCB (main).

### Abnormality Judgment:

Continue for 5 seconds.

## Troubleshooting:

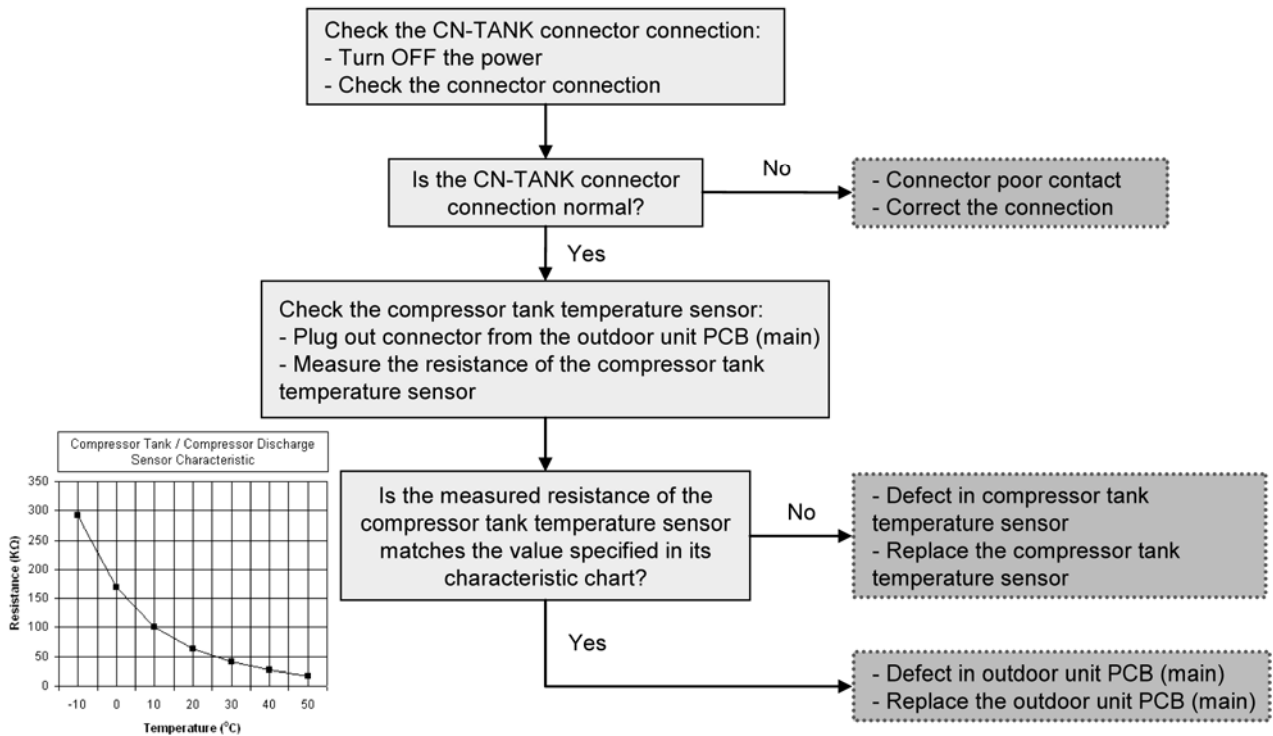

### 17.5.3 Water Pump Abnormality (H20)

#### Malfunction Decision Conditions:

During startup and operation of cooling and heating, the rotation speed detected by the IPM of water pump motor during water pump operation is used to determine abnormal water pump (feedback of rotation > 6,000rpm or < 1,000rpm).

#### Malfunction Caused:

- 1 Operation stop due to short circuit inside the water pump motor winding.
- 2 Operation stop due to breaking of wire inside the water pump motor.
- 3 Operation stop due to breaking of water pump lead wires.
- 4 Operation stop due to water pump motor IPM malfunction.
- 5 Operation error due to faulty indoor unit PCB.

#### Abnormality Judgment:

Continue for 5 seconds.

#### Troubleshooting:



**Caution**

For safety reason and to prevent component breakdown, always switch off the power before remove and connect the component.

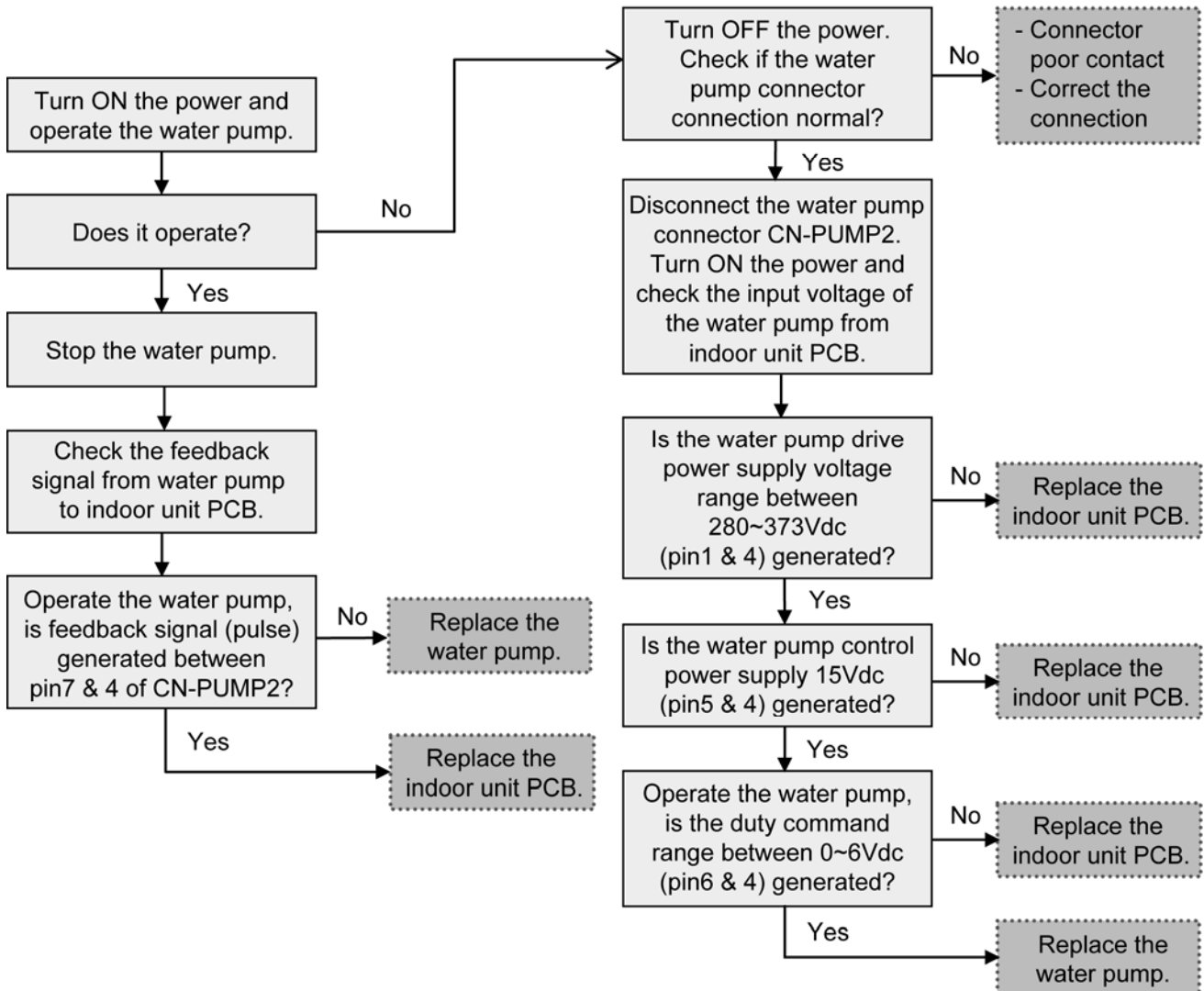



## 17.5.4 Indoor Refrigerant Liquid Temperature Sensor Abnormality (H23)

### Malfunction Decision Conditions:

During startup and operation of cooling and heating, the temperatures detected by the indoor refrigerant liquid temperature sensor are used to determine sensor error.

### Malfunction Caused:

- 1 Faulty connector connection.
- 2 Faulty sensor.
- 3 Faulty indoor unit PCB (main).

### Abnormality Judgment:

Continue for 5 seconds.

### Troubleshooting:



**Caution**

For safety reason and to prevent component breakdown, always switch off the power before remove and connect the component.

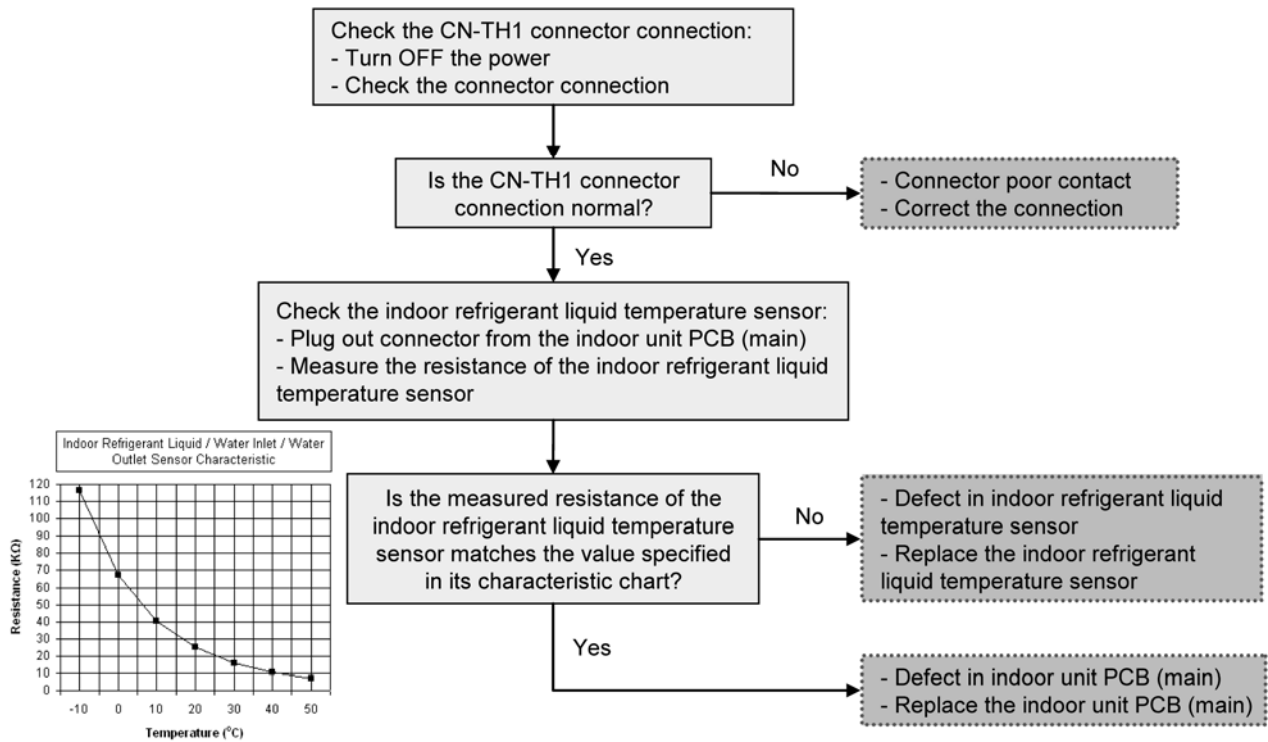

## 17.5.5 Service Valve Error (H27)

### Malfunction Decision Conditions:

During cooling operation, when:-

[a] Indoor refrigerant pipe temperature at compressor startup - present indoor refrigerant pipe temperature  $< 2^{\circ}\text{C}$

[b] Present high pressure - high pressure at compressor startup  $< 5\text{kg}/\text{cm}^2$

\*\*Judgment only for first time cooling operation and not during pump down operation.

### Malfunction Caused:

- 1 3 way valves closed.
- 2 Faulty high pressure sensor.
- 3 Faulty indoor refrigerant pipe temperature sensor
- 4 Faulty outdoor unit PCB (main).

### Abnormality Judgment:

Continue for 5 minutes.

### Troubleshooting:



**Caution**

For safety reason and to prevent component breakdown, always switch off the power before remove and connect the component.

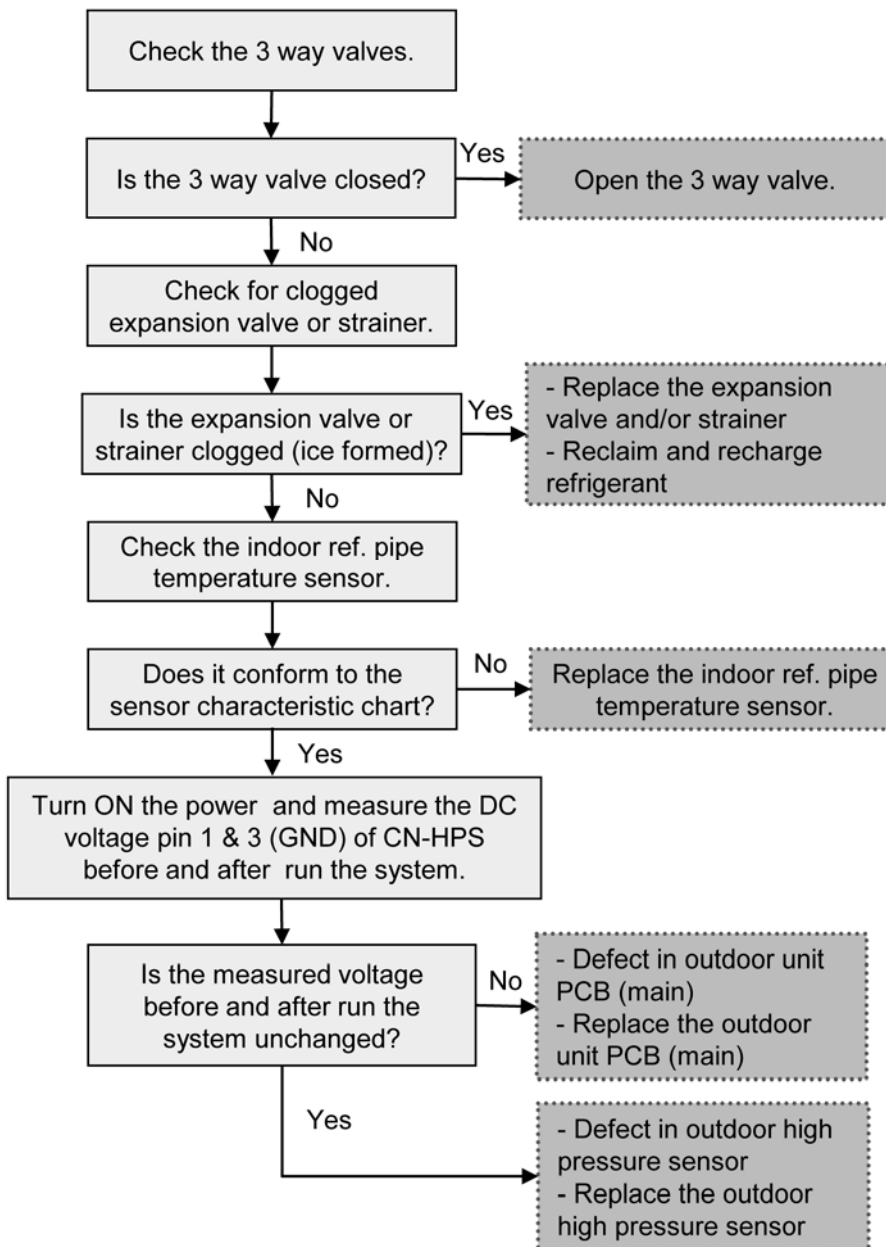

## 17.5.6 Compressor Low Pressure Protection (H42)

### Malfunction Decision Conditions:

During operation of heating and after 5 minutes compressor ON, when outdoor pipe temperature below -29°C or above 26°C is detected by the outdoor pipe temperature sensor.

### Malfunction Caused:

- 1 Dust accumulation on the outdoor unit heat exchanger.
- 2 Air short circuit at outdoor unit.
- 3 2 way valve partially closed.
- 4 Faulty outdoor unit fan motor.
- 5 Refrigerant shortage (refrigerant leakage).
- 6 Clogged expansion valve or strainer.
- 7 Faulty outdoor pipe temperature sensor.
- 8 Faulty outdoor unit main PCB (main).

### Troubleshooting:



**Caution**

For safety reason and to prevent component breakdown, always switch off the power before remove and connect the component.

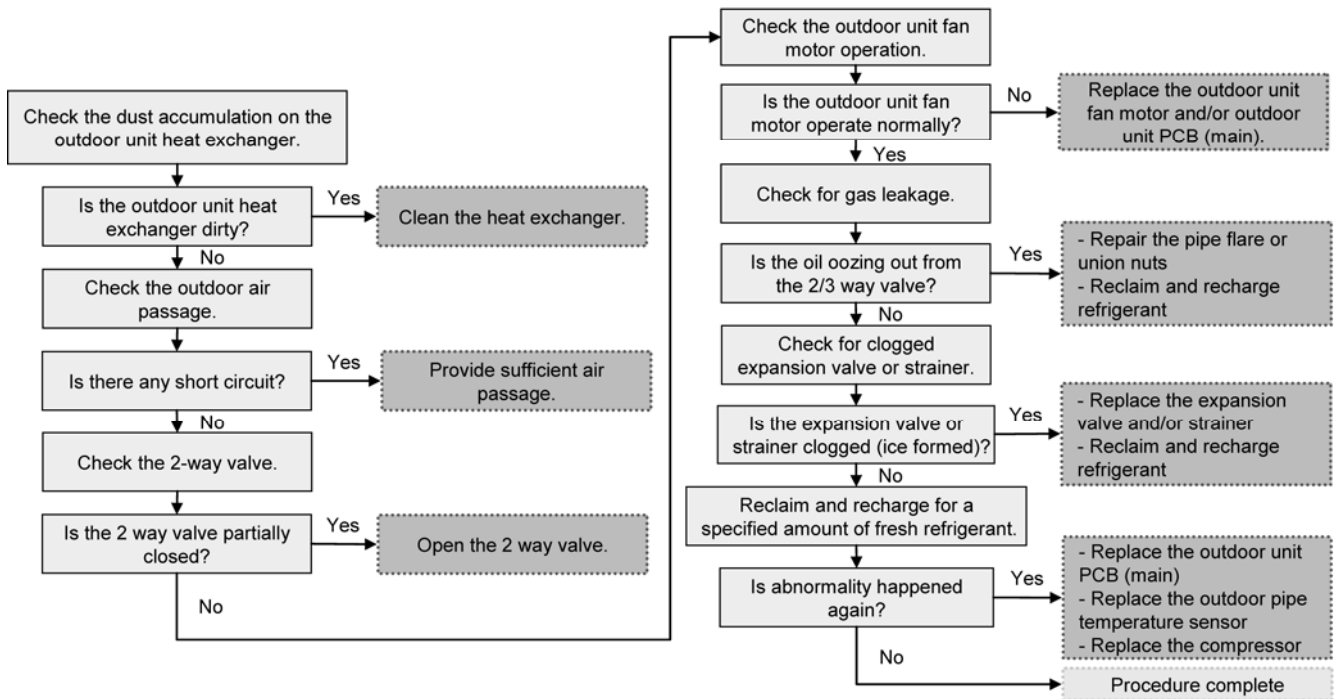

## 17.5.7 Water Flow Switch Abnormality (H62)

### Malfunction Decision Conditions:

During operation of cooling and heating, the water flow detected by the indoor water flow switch is used to determine water flow error.

### Malfunction Caused:

- 1 Faulty water pump.
- 2 Water leak in system.
- 3 Faulty connector connection.
- 4 Faulty water flow switch.
- 5 Faulty indoor unit PCB (main).

### Abnormality Judgment:

Continue for 10 seconds (but no judgment for 9 minutes after compressor startup/restart).

### Troubleshooting:



**Caution**

For safety reason and to prevent component breakdown, always switch off the power before remove and connect the component.

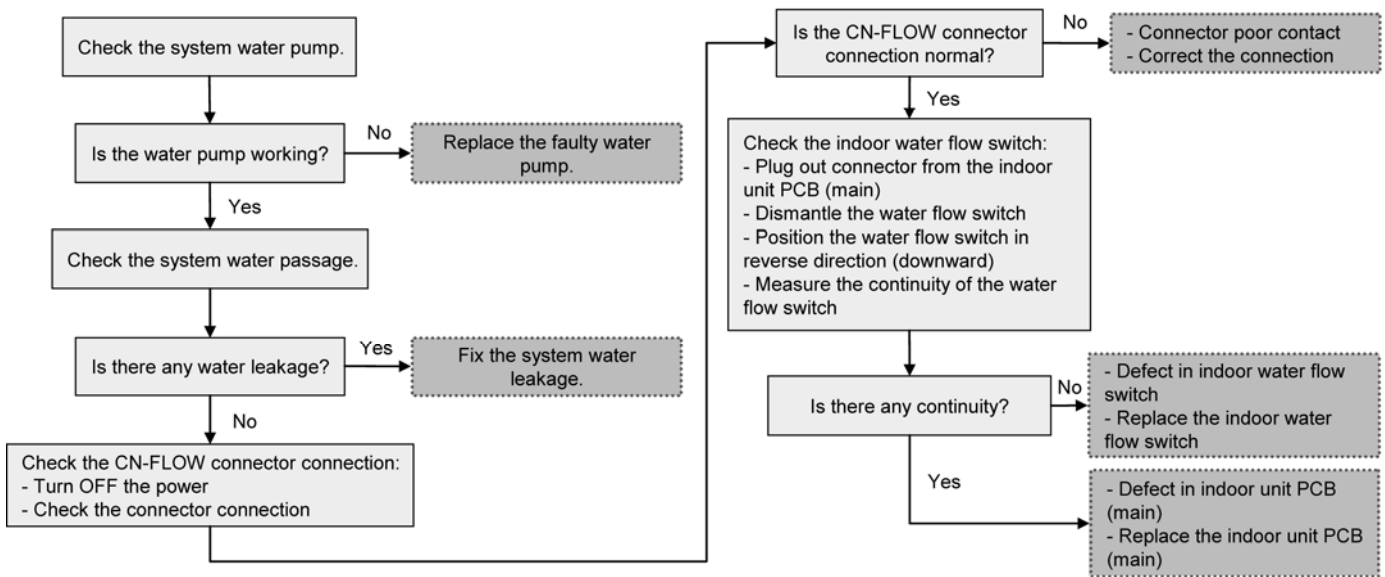

## 17.5.8 Outdoor High Pressure Abnormality (H64)

### Malfunction Decision Conditions:

During operation of cooling and heating, when the outdoor high pressure sensor output signal is 0 Vdc or 5 Vdc.

### Malfunction Caused:

- 1 Faulty connector connection.
- 2 Faulty sensor.
- 3 Faulty outdoor unit PCB (main).

### Abnormality Judgment:

Continue 4 times in 20 minutes.

### Troubleshooting:



**Caution**

For safety reason and to prevent component breakdown, always switch off the power before remove and connect the component.

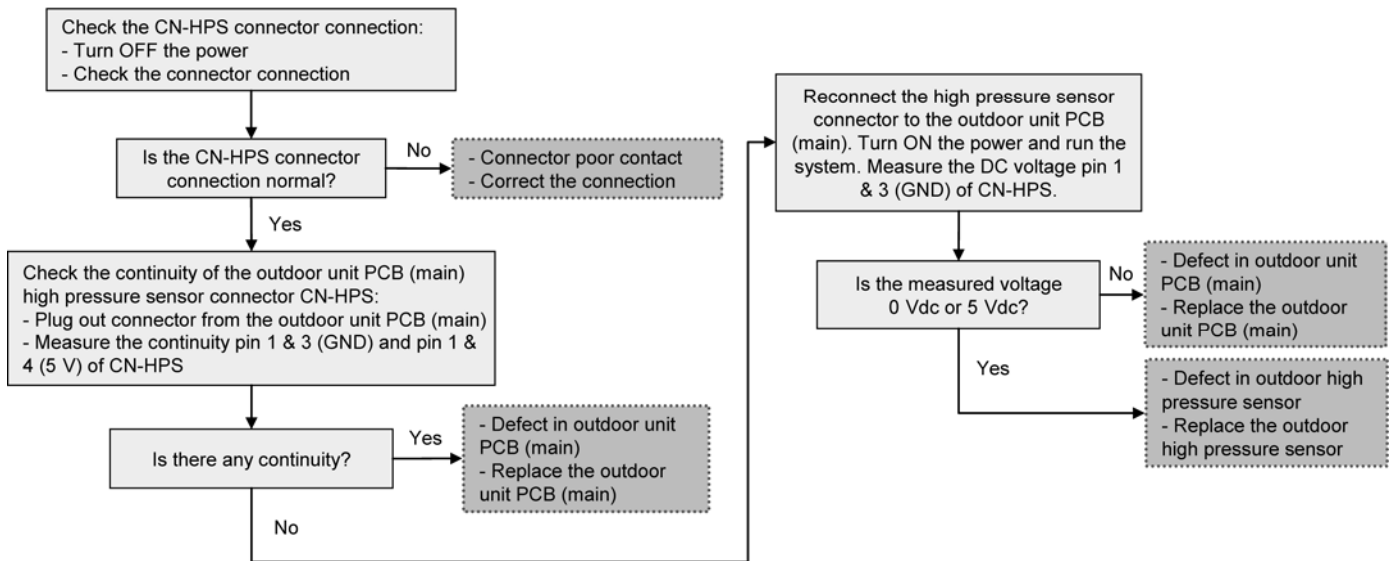

## 17.5.9 Deice Circulation Error (H65)

### Malfunction Decision Conditions:

During startup and operation of deice (mode 2), the water flow (> 10l/min) detected by the water flow switch is used to determine deice circulation error.

### Malfunction Caused:

- 1 Water flow in air-to-water heatpump indoor unit circuitry.
- 2 Faulty indoor unit water flow switch.
- 3 Faulty indoor unit water pump.
- 4 Faulty indoor unit PCB.

### Abnormality Judgment:

Continue for 10 seconds.

## Troubleshooting:



**Caution**

For safety reason and to prevent component breakdown, always switch off the power before remove and connect the component.

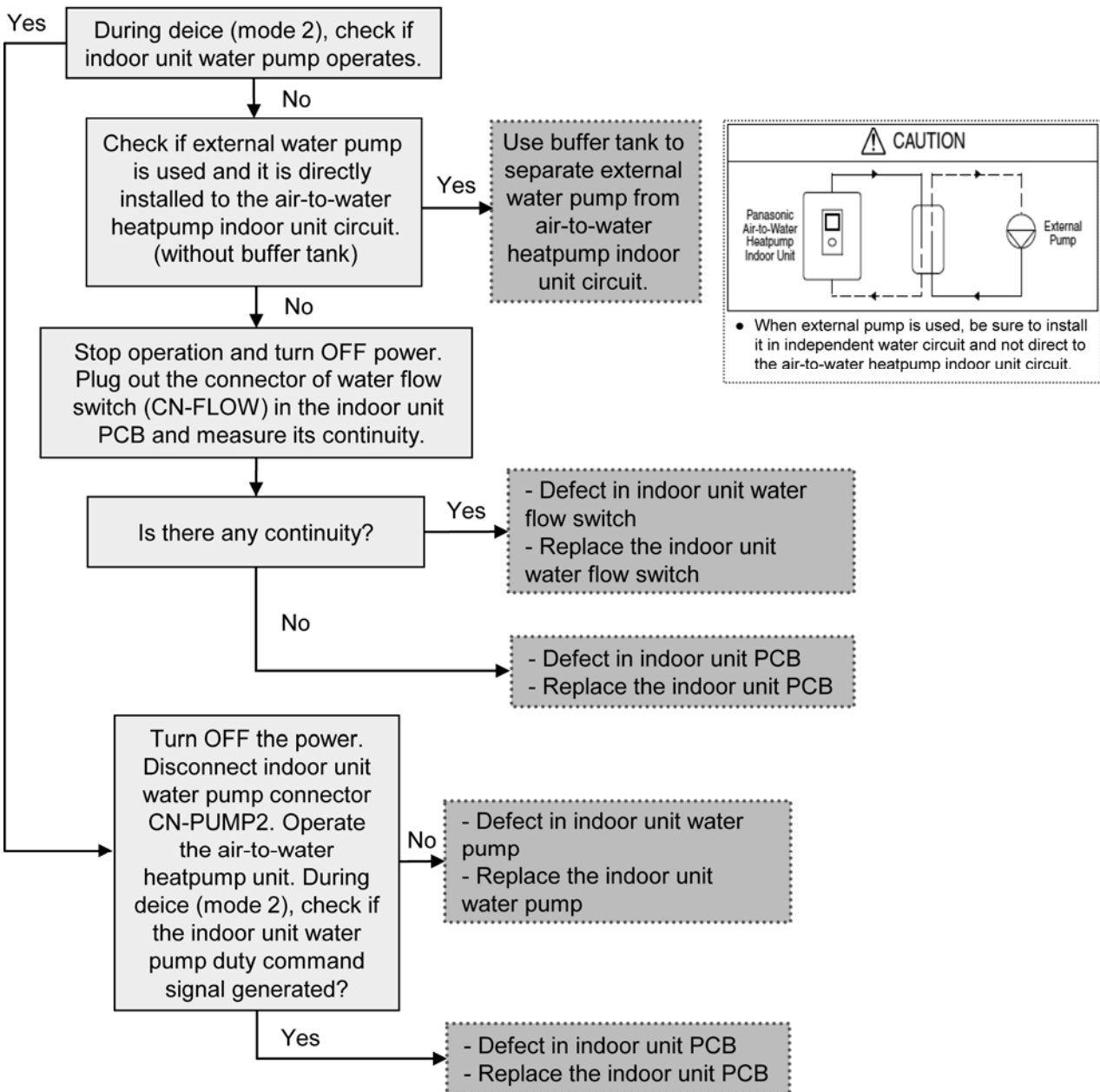

## 17.5.10 Indoor Backup Heater OLP Abnormality (H70)

### Malfunction Decision Conditions:

During operation of indoor backup heater, when no power supplies to indoor backup heater or OLP open circuit.

### Malfunction Caused:

- 1 Faulty power supply connector connection.
- 2 Faulty connector connection.
- 3 Faulty indoor backup heater overload protector (OLP).
- 4 Faulty indoor unit PCB (main).

### Abnormality Judgment:

Continue for 60 seconds.

### Troubleshooting:



**Caution**

For safety reason and to prevent component breakdown, always switch off the power before remove and connect the component.

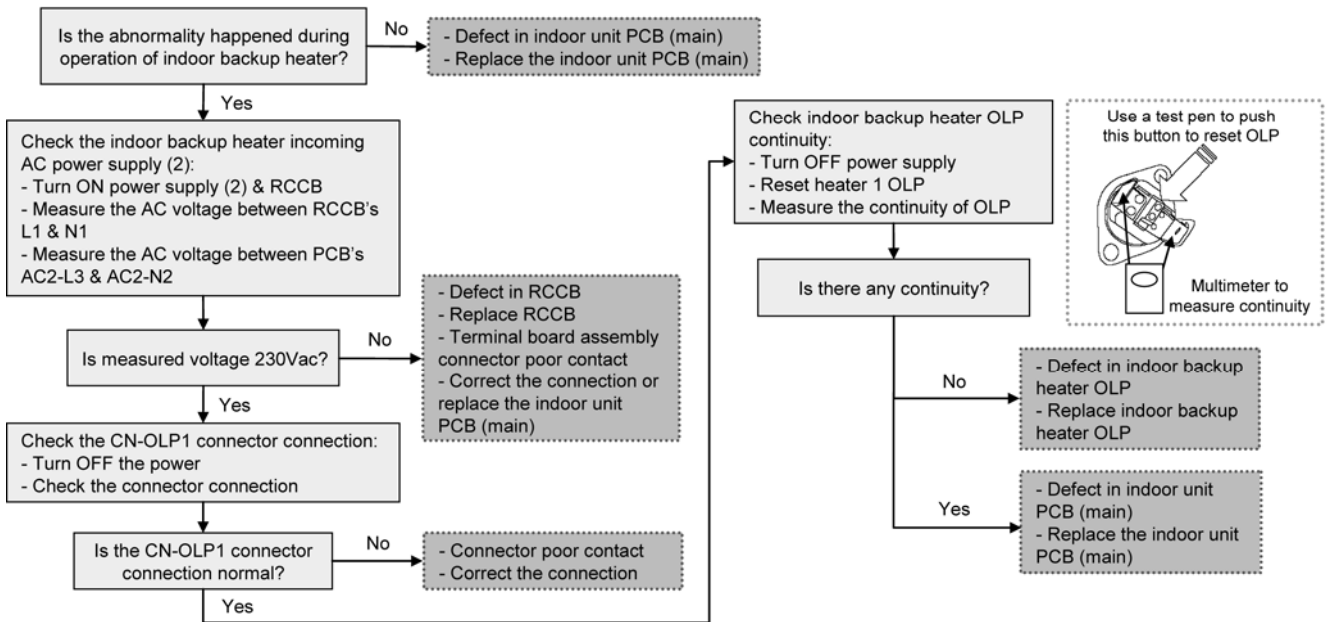

## 17.5.11 Tank Temperature Sensor Abnormality (H72)

### Malfunction Decision Conditions:

When tank connection is set to ON, the temperatures detected by the tank temperature sensor are used to determine sensor error.

### Malfunction Caused:

- 1 Faulty connector connection.
- 2 Faulty sensor.
- 3 Faulty indoor unit PCB (main).

### Abnormality Judgment:

Continue for 5 seconds.

### Troubleshooting:



**Caution**

For safety reason and to prevent component breakdown, always switch off the power before remove and connect the component.

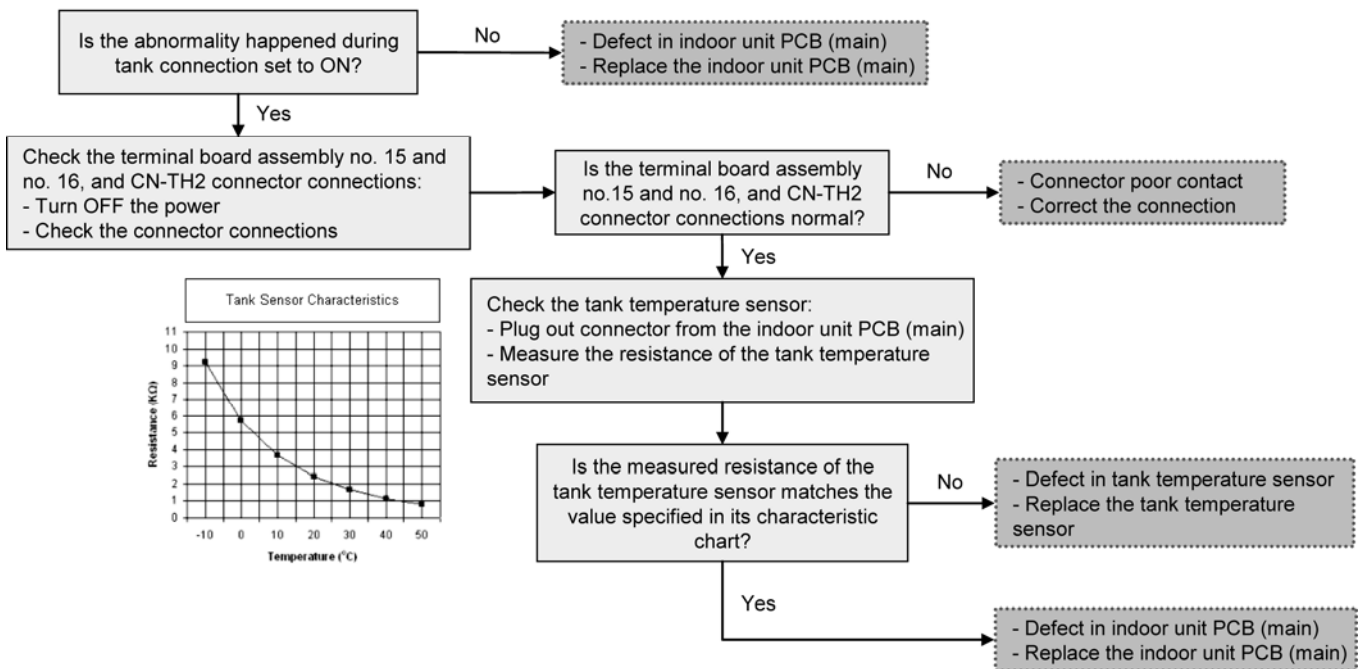



## 17.5.12 Indoor-Control Panel Communication Abnormality (H76)

### Malfunction Decision Conditions:

During standby and operation of cooling and heating, indoor-control panel error occur.

### Malfunction Caused:

- 1 Faulty connector connection.
- 2 Faulty control panel.
- 3 Faulty indoor unit PCB (main).

### Troubleshooting:



**Caution**

For safety reason and to prevent component breakdown, always switch off the power before remove and connect the component.

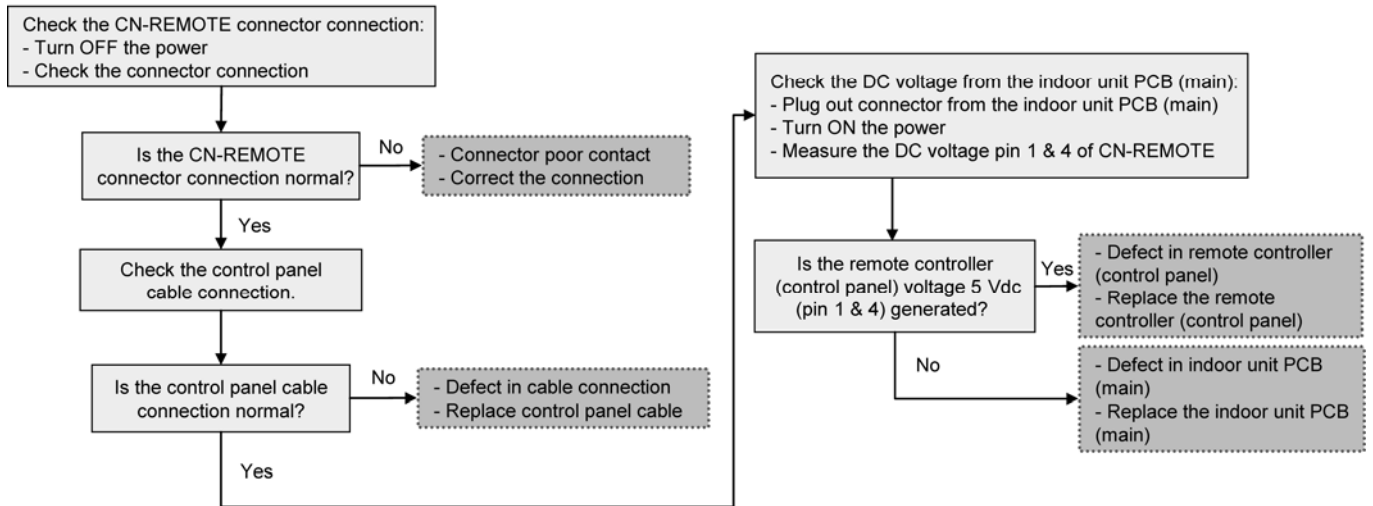

### 17.5.13 Indoor/Outdoor Abnormal Communication (H90)

#### Malfunction Decision Conditions:

During operation of cooling and heating, the data received from outdoor unit in indoor unit signal transmission is checked whether it is normal.

#### Malfunction Caused:

- 1 Faulty outdoor unit PCB (main).
- 2 Faulty indoor unit PCB (main).
- 3 Indoor-outdoor signal transmission error due to wrong wiring.
- 4 Indoor-outdoor signal transmission error due to breaking of wire in the connection wires between the indoor and outdoor units.
- 5 Indoor-outdoor signal transmission error due to disturbed power supply waveform.

#### Abnormality Judgment:

Continue for 1 minute after operation.

#### Troubleshooting:



For safety reason and to prevent component breakdown, always switch off the power before remove and connect the component.

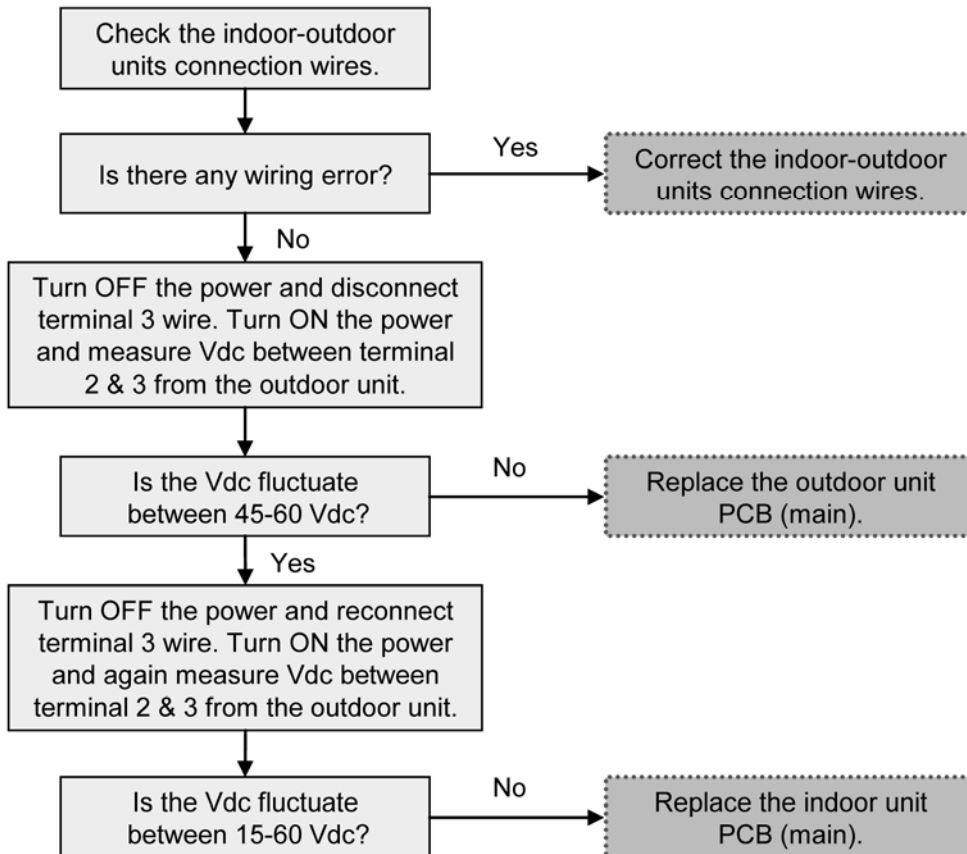

## 17.5.14 Tank Booster Heater OLP Abnormality (H91)

### Malfunction Decision Conditions:

During operation of tank booster heater, and tank booster heater OLP open circuit.

### Malfunction Caused:

- 1 Faulty connector connection.
- 2 Faulty tank booster heater overload protector (OLP).
- 3 Faulty indoor unit PCB (main).

### Abnormality Judgment:

Continue for 60 seconds.

### Troubleshooting:



**Caution**

For safety reason and to prevent component breakdown, always switch off the power before remove and connect the component.

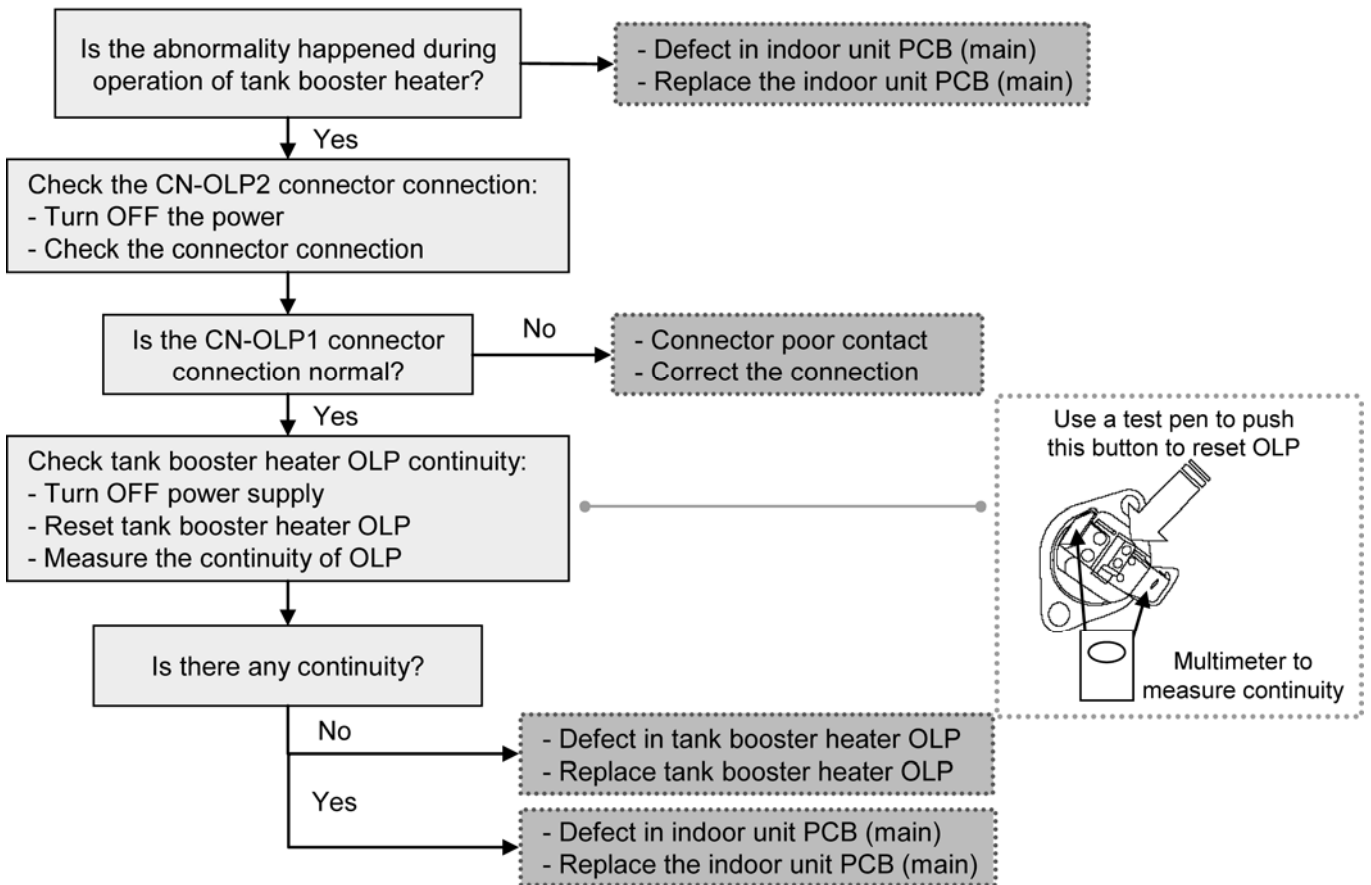

## 17.5.15 Unspecified Voltage between Indoor and Outdoor (H95)

### Malfunction Decision Conditions:

The supply power is detected for its requirement by the indoor/outdoor transmission.

### Malfunction Caused:

- 1 Insufficient power supply.
- 2 Faulty outdoor unit PCB (noise filter/main).

### Troubleshooting:



For safety reason and to prevent component breakdown, always switch off the power before remove and connect the component.

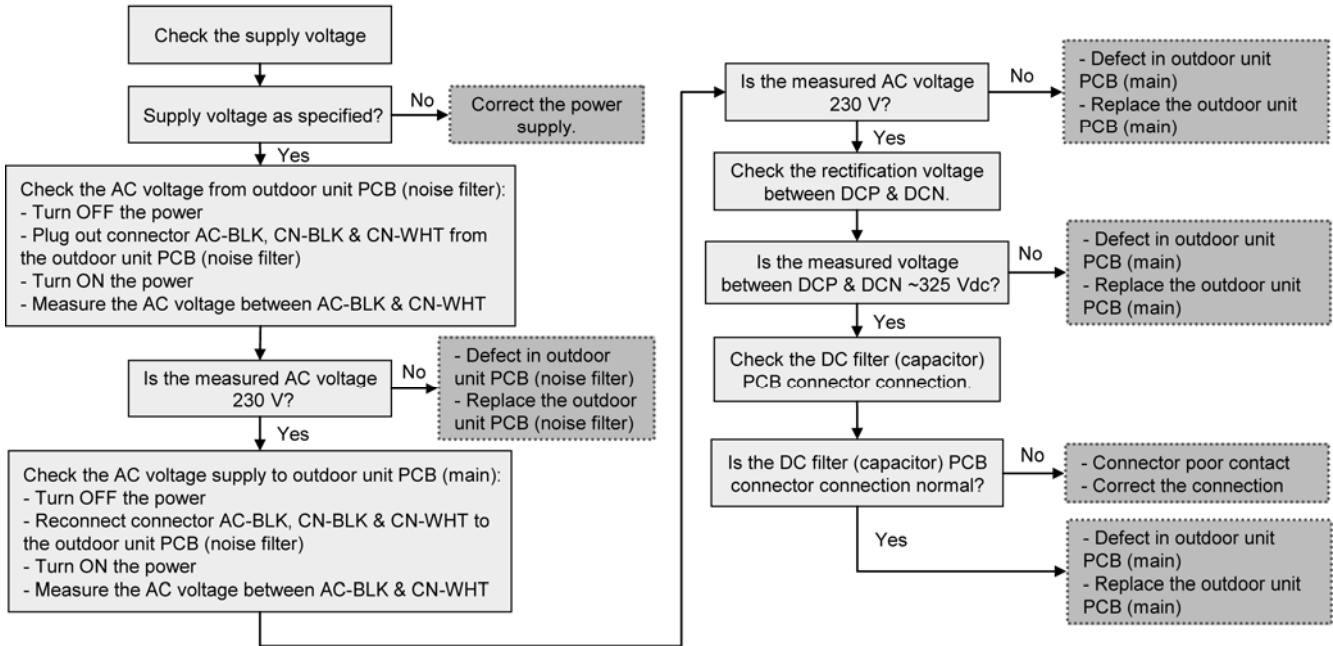

## 17.5.16 Outdoor High Pressure Protection (H98)

### Malfunction Decision Conditions:

During operation of heating, when pressure 4.0 MPa and above is detected by outdoor high pressure sensor.

### Malfunction Caused:

- 1 Faulty water pump.
- 2 Insufficient water flow rate in system.
- 3 Water leak in system.
- 4 2/3 way closed.
- 5 Clogged expansion valve or strainer.
- 6 Excessive refrigerant.
- 7 Faulty outdoor high pressure sensor.
- 8 Faulty outdoor unit PCB (main).

### Troubleshooting:



**Caution**

For safety reason and to prevent component breakdown, always switch off the power before remove and connect the component.

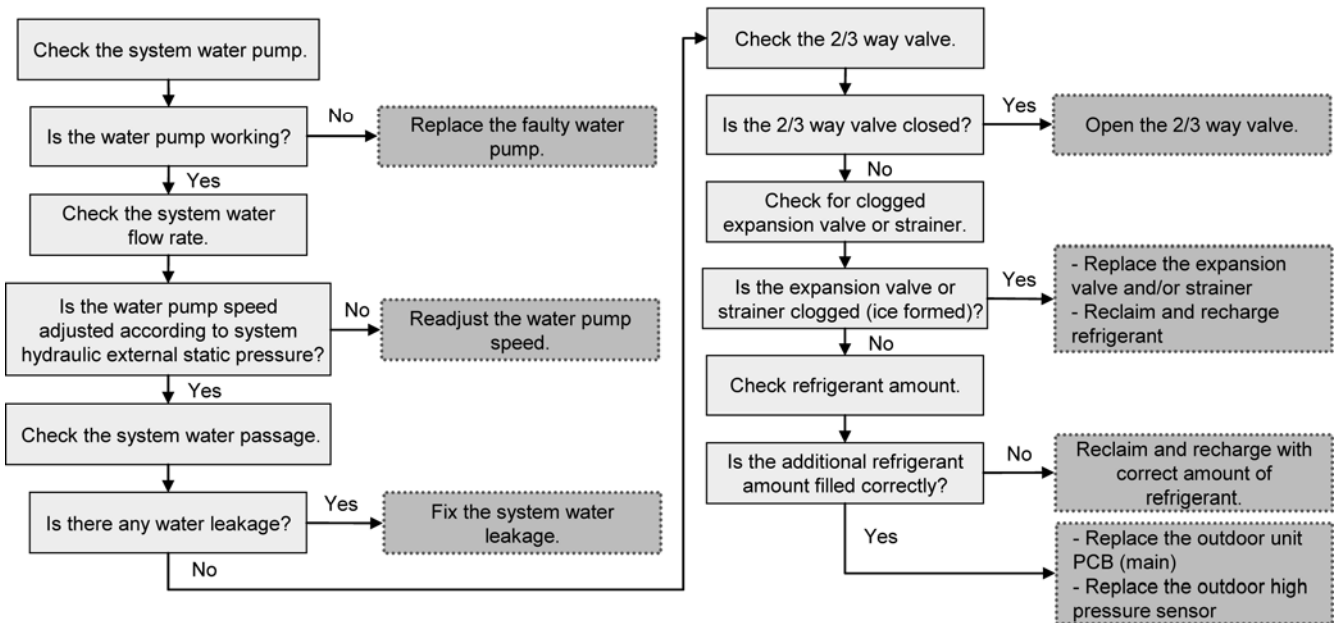

## 17.5.17 Indoor Freeze-up Protection (H99)

### Malfunction Decision Conditions:

During anti-freezing control in cooling operation, when the indoor refrigerant liquid temperature  $< 0^{\circ}\text{C}$ .

### Malfunction Caused:

- 1 Faulty water pump.
- 2 Insufficient water flow rate in system.
- 3 Water leak in system.
- 4 2 way valve partially closed.
- 5 Clogged expansion valve or strainer.
- 6 Refrigerant shortage (refrigerant leakage).
- 7 Faulty indoor refrigerant liquid temperature sensor.
- 8 Faulty indoor unit PCB (main).

### Troubleshooting:



**Caution**

For safety reason and to prevent component breakdown, always switch off the power before remove and connect the component.

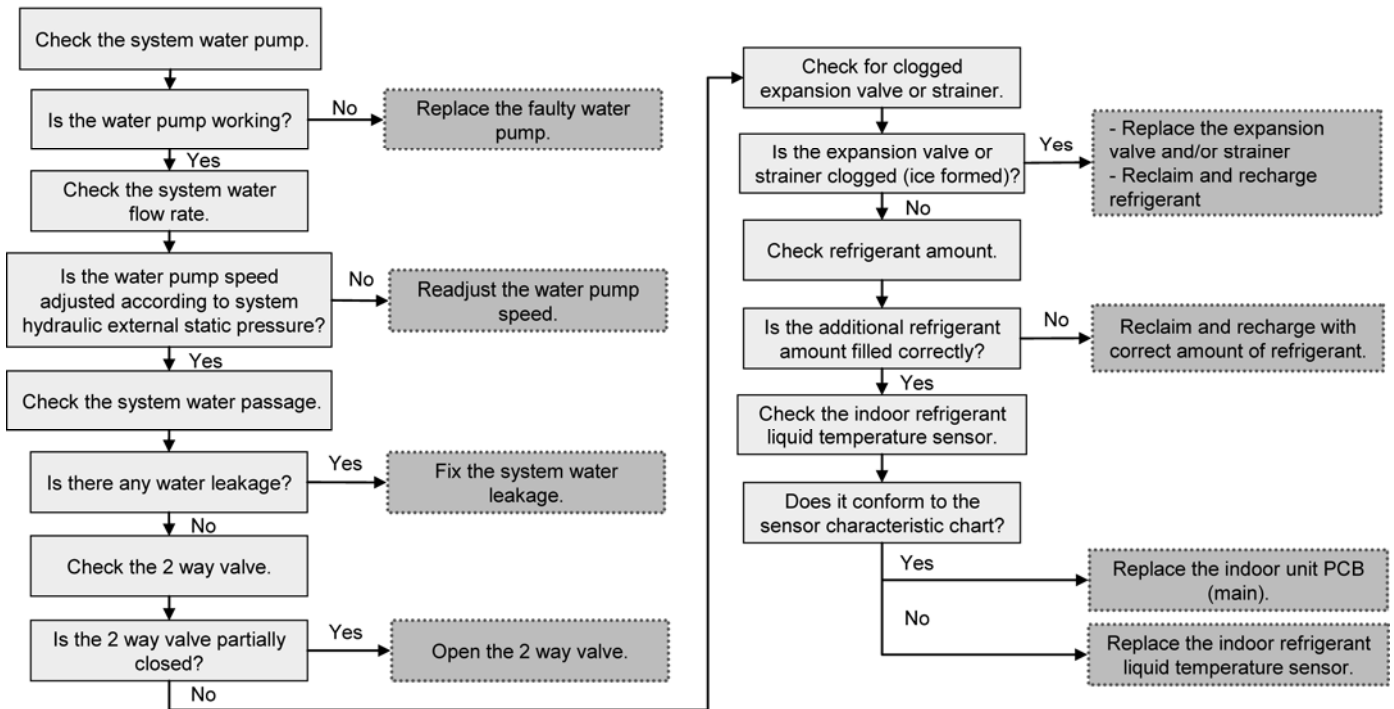

## 17.5.18 Outdoor High Pressure Switch Activate (F12)

### Malfunction Decision Conditions:

During operation of cooling and heating, when pressure 4.5 MPa and above is detected by outdoor high pressure switch.

### Malfunction Caused:

- 1 Dust accumulation on the outdoor unit heat exchanger.
- 2 Air short circuit at outdoor unit.
- 3 Faulty water pump.
- 4 Insufficient water flow rate in system.
- 5 Water leak in system.
- 6 2/3 way valve closed.
- 7 Clogged expansion valve or strainer.
- 8 Excessive refrigerant.
- 9 Faulty outdoor high pressure sensor and switch.
- 10 Faulty outdoor unit PCB.

### Abnormality Judgment:

Continue 4 times in 20 minutes.

### Troubleshooting:



**Caution**

For safety reason and to prevent component breakdown, always switch off the power before remove and connect the component.

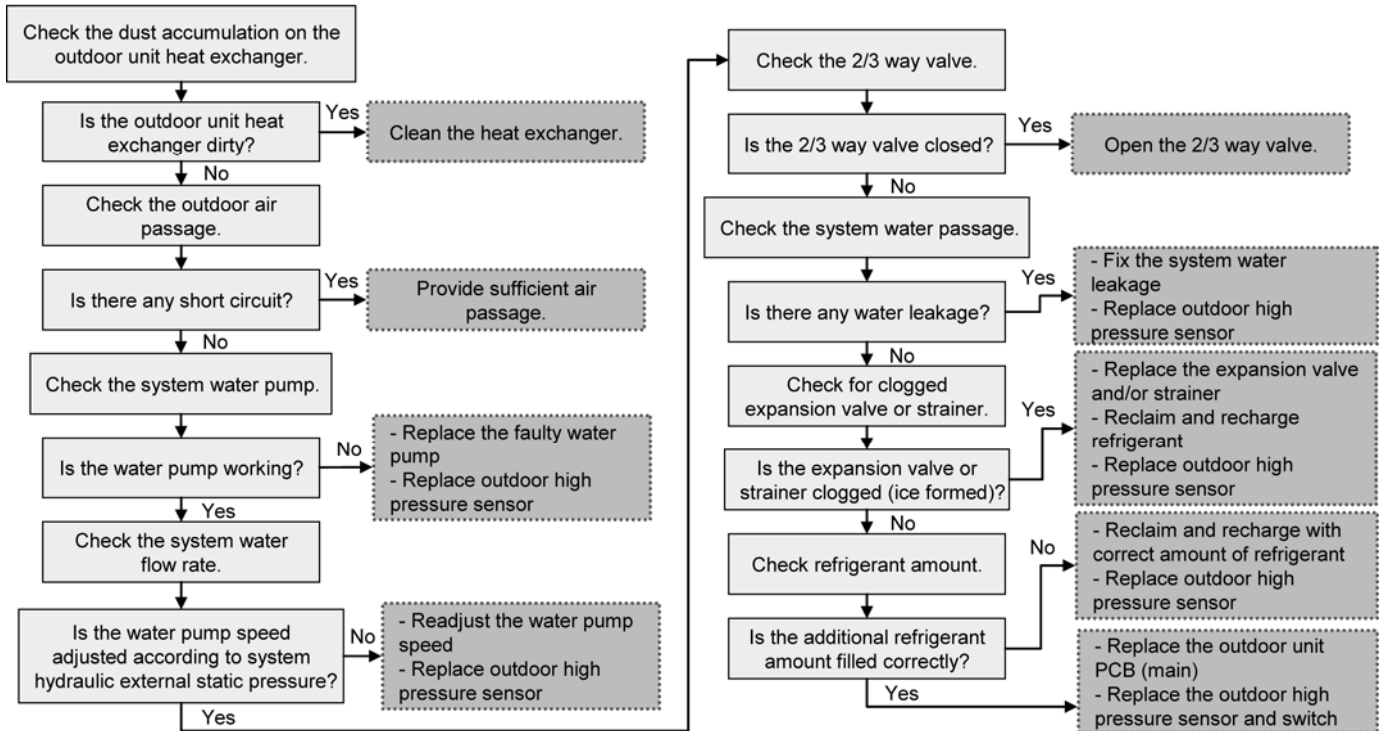

## 17.5.19 Compressor Rotation Failure (F14)

### Malfunction Decision Conditions:

A compressor rotation failure is detected by checking the compressor running condition through the position detection circuit.

### Malfunction Caused:

- 1 Compressor terminal disconnect.
- 2 Faulty outdoor unit PCB (main).
- 3 Faulty compressor.

### Abnormality Judgment:

Continue 4 times in 20 minutes.

## Troubleshooting:



**Caution**

For safety reason and to prevent component breakdown, always switch off the power before remove and connect the component.

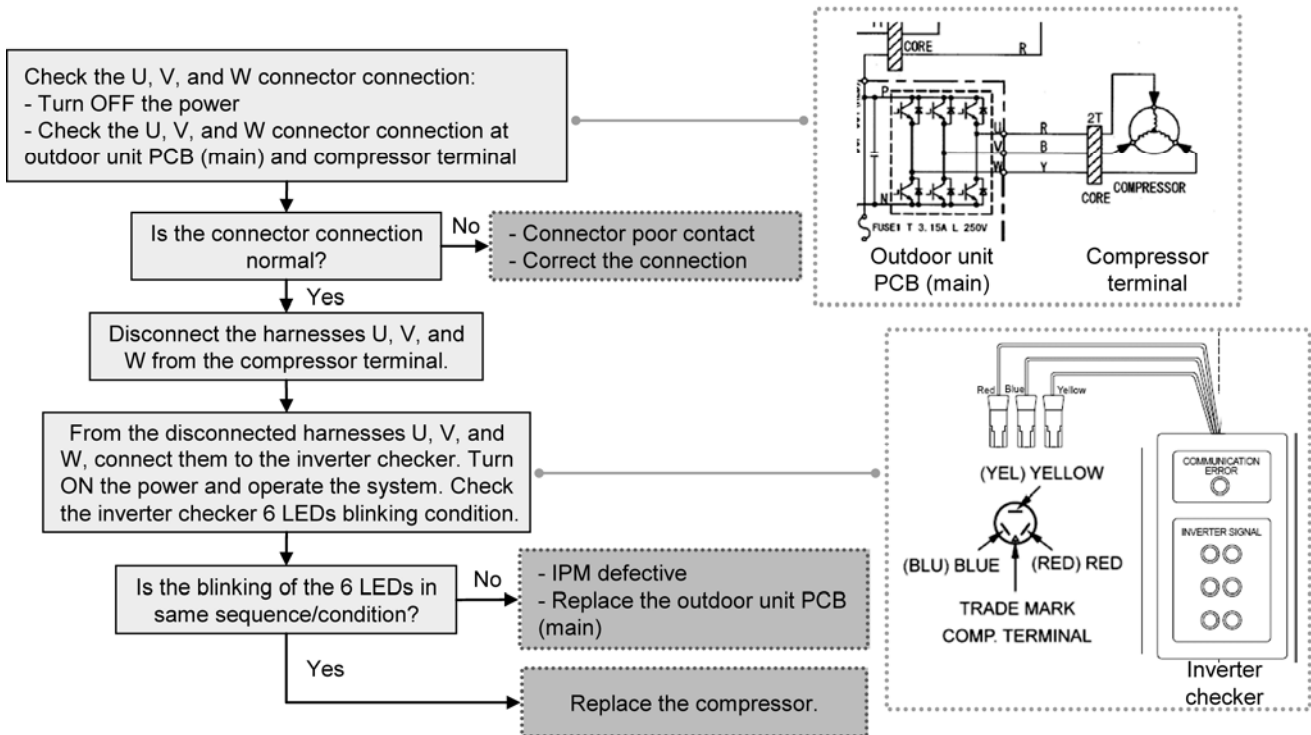



## 17.5.20 Outdoor Fan Motor (DC Motor) Mechanism Locked (F15)

### Malfunction Decision Conditions:

The rotation speed detected by the Hall IC of the fan motor during fan motor operation is used to determine abnormal fan motor (feedback of rotation > 2550 rpm or < 50 rpm).

### Malfunction Caused:

- 1 Operation stop due to short circuit inside the fan motor winding.
- 2 Operation stop due to breaking of wire inside the fan motor.
- 3 Operation stop due to breaking of fan motor lead wires.
- 4 Operation stop due to fan motor Hall IC malfunction.
- 5 Operation error due to faulty outdoor unit PCB.

### Abnormality Judgment:

Continue 2 times in 30 minutes.

### Troubleshooting:



**Caution**

For safety reason and to prevent component breakdown, always switch off the power before remove and connect the component.

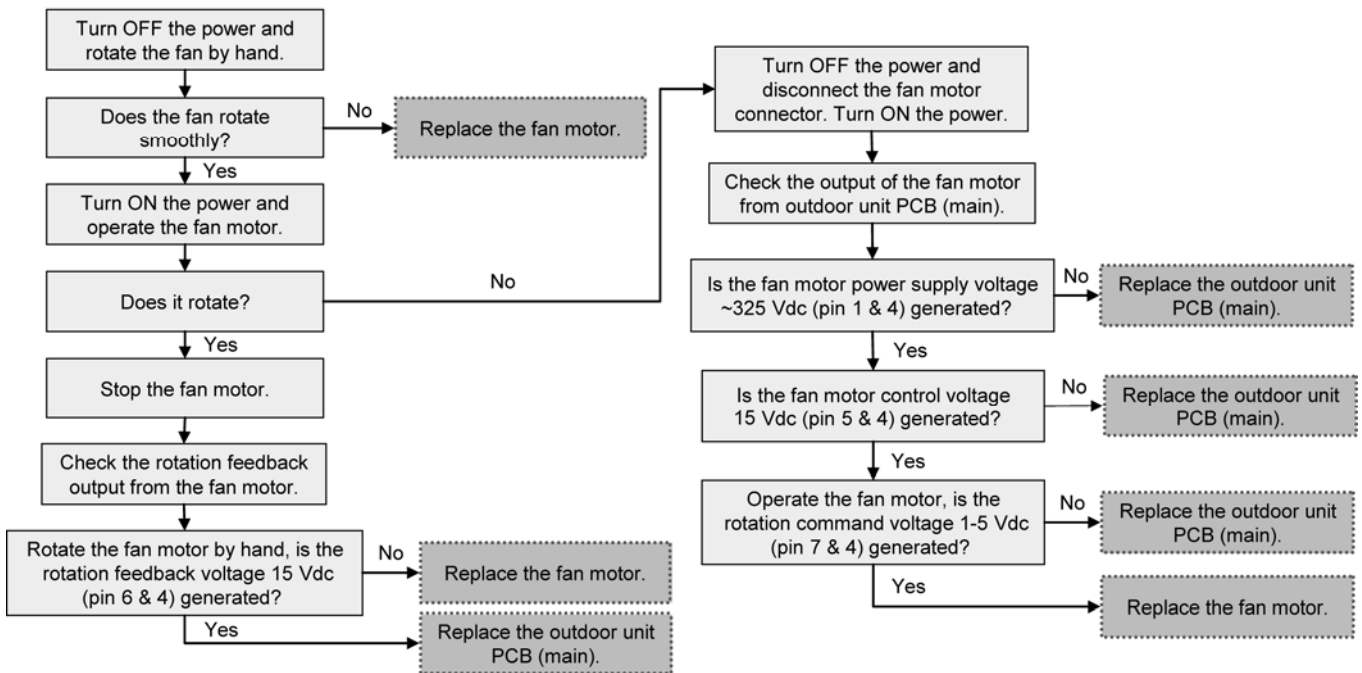

## 17.5.21 Input Over Current Detection (F16)

### Malfunction Decision Conditions:

During operation of cooling and heating, when outdoor current above 6.21 A (Heating) and 6.21 A (Cooling) [UD09FE8] and 7.35 A (Heating) and 6.51 A (Cooling) [UD12FE8] and 7.99 A (Heating) and 7.89 A (Cooling) [UD14FE8] and 8.53 A (Heating) and 8.43 A (Cooling) [UD16FE8] is detected by the current transformer (CT) in the outdoor unit PCB.

### Malfunction Caused:

- 1 Excessive refrigerant.
- 2 Faulty outdoor unit PCB (main).

### Abnormality Judgment:

Continue 3 times in 20 minutes.

### Troubleshooting:



For safety reason and to prevent component breakdown, always switch off the power before remove and connect the component.

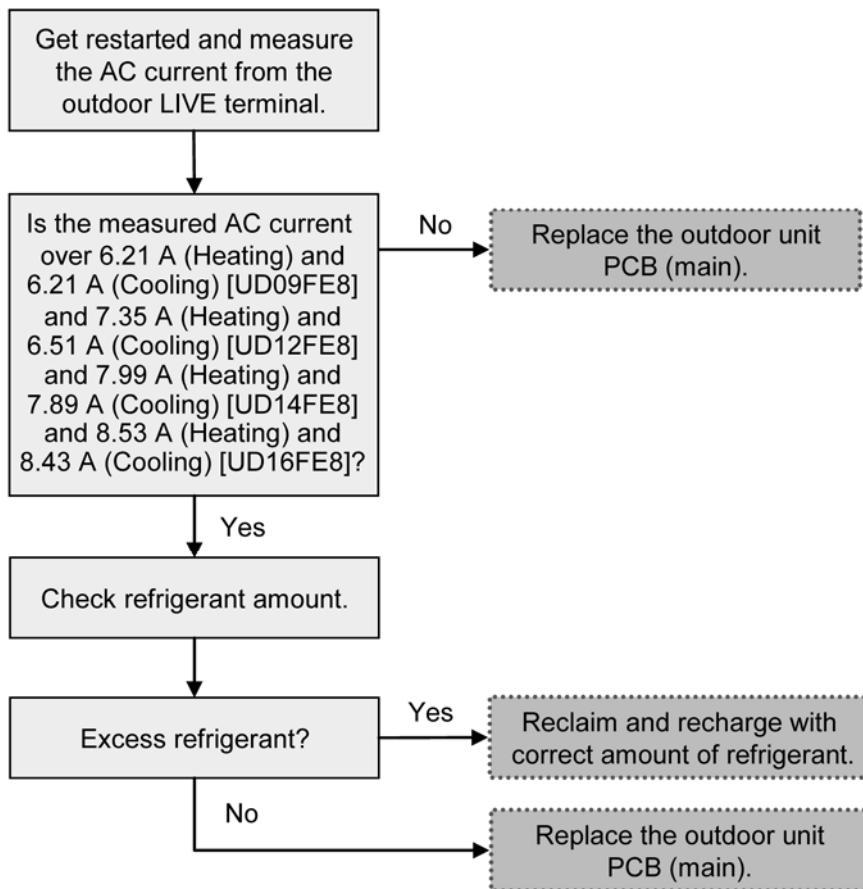

## 17.5.22 Compressor Overheating (F20)

### Malfunction Decision Conditions:

During operation of cooling and heating, when temperature above 112°C is detected by the compressor tank temperature sensor.

### Malfunction Caused:

- 1 Faulty compressor tank temperature sensor.
- 2 2/3 way valve closed.
- 3 Refrigerant shortage (refrigerant leakage).
- 4 Clogged expansion valve or strainer.
- 5 Faulty outdoor unit PCB (main).
- 6 Faulty compressor.

### Abnormality Judgment:

Continue 4 times in 30 minutes.

### Troubleshooting:



**Caution**

For safety reason and to prevent component breakdown, always switch off the power before remove and connect the component.

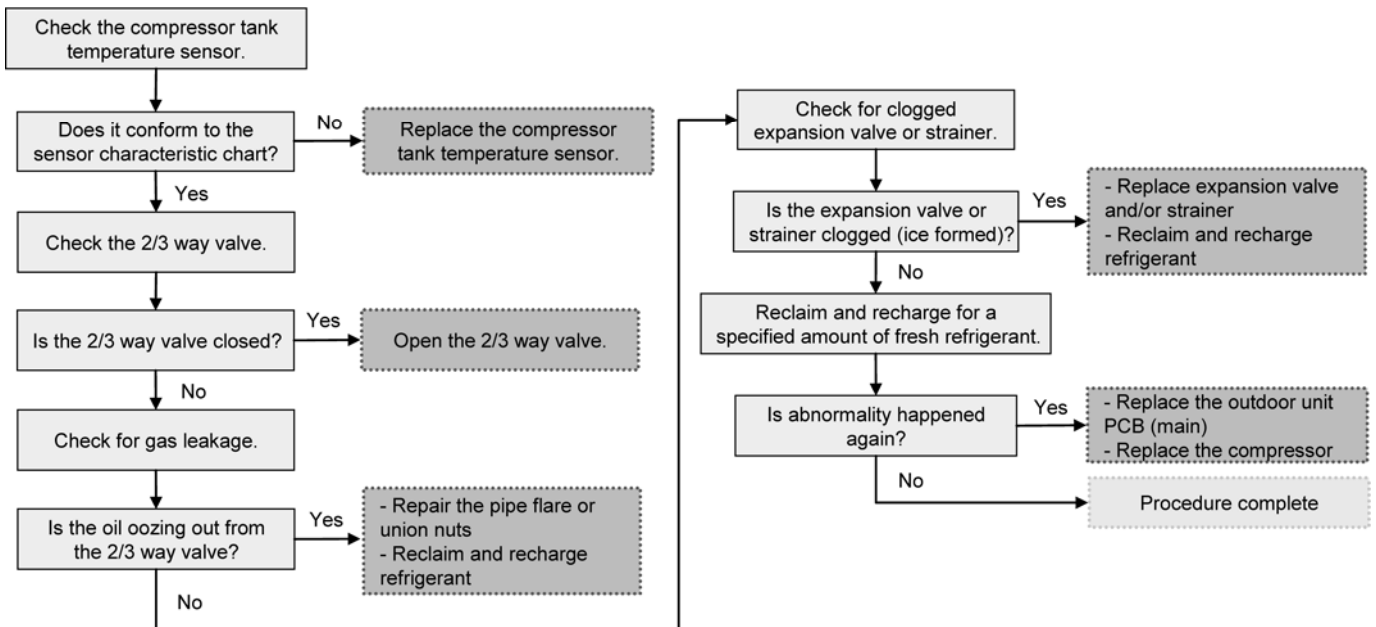

### 17.5.23 IPM Overheating (F22)

#### Malfunction Decision Conditions:

During operation of cooling and heating, when temperature 95°C is detected by the outdoor IPM temperature sensor.

#### Malfunction Caused:

- 1 Faulty outdoor unit fan motor.
- 2 Faulty outdoor unit PCB (main).

#### Abnormality Judgment:

Continue 3 times in 30 minutes.

#### Troubleshooting:



For safety reason and to prevent component breakdown, always switch off the power before remove and connect the component.

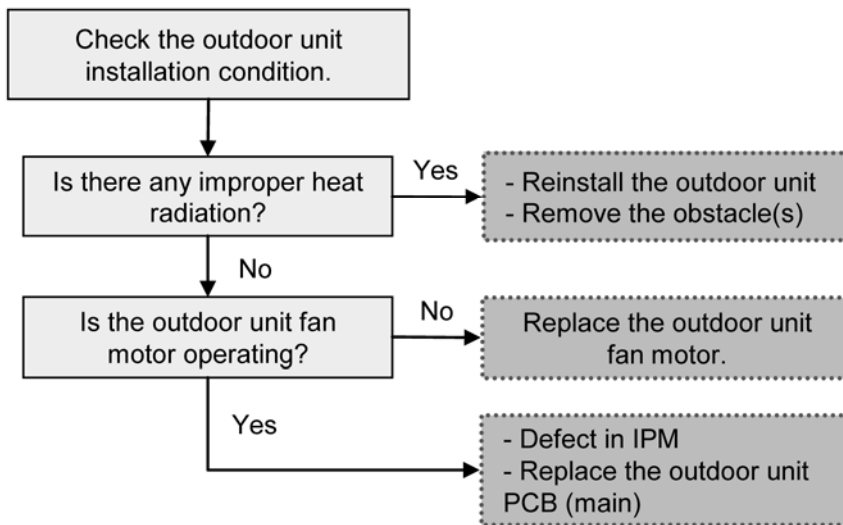

## 17.5.24 Output Over Current Detection (F23)

### Malfunction Decision Conditions:

During operation of cooling and heating, when outdoor DC current is above 34 A is detected by the IPM DC Peak sensing circuitry in the outdoor unit PCB (main).

### Malfunction Caused:

- 1 Faulty outdoor unit PCB (main).
- 2 Faulty compressor.

### Abnormality Judgment:

Continue for 7 times.

## Troubleshooting:



**Caution**

For safety reason and to prevent component breakdown, always switch off the power before remove and connect the component.

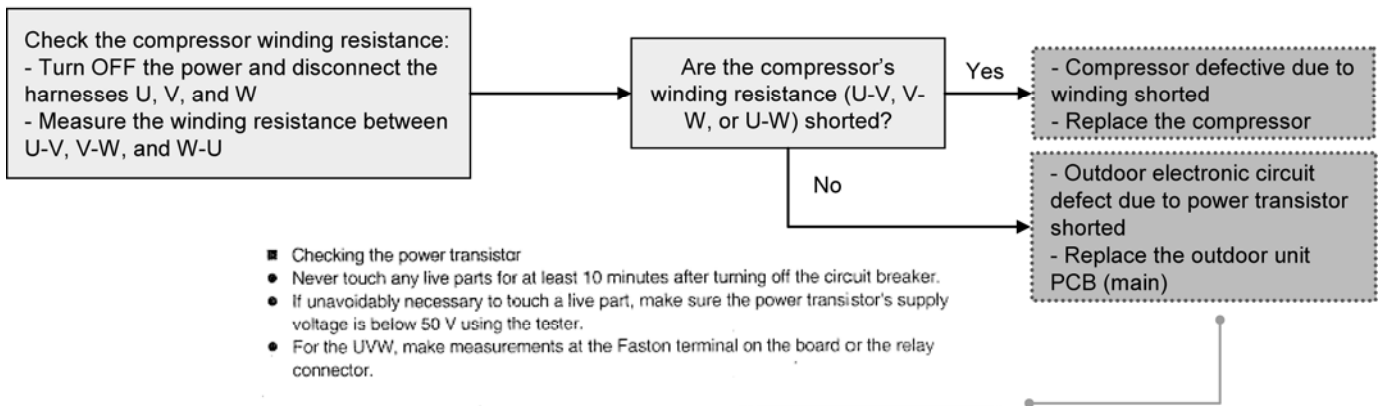

Tester's negative terminal	Power transistor (+)	UVW	Power transistor (-)	UVW
Tester's positive terminal	UVW	Power transistor (+)	UVW	Power transistor (-)
Normal resistance	Several kohms to several Mohms			
Abnormal resistance	0 or ∞			

## 17.5.25 Refrigeration Cycle Abnormality (F24)

### Malfunction Decision Conditions:

- 1 During operation of cooling and heating, compressor frequency > Frated.
- 2 During operation of cooling and heating, running current:  $0.65 A < I < 1.65 A$ .
- 3 During operation of cooling, water inlet temperature - indoor refrigerant liquid temperature < 5°C.
- 4 During operation of heating, indoor refrigerant liquid temperature - water inlet temperature < 5°C.

### Malfunction Caused:

- 1 Faulty water inlet or indoor refrigerant liquid temperature sensors.
- 2 2/3 way valve closed.
- 3 Refrigerant shortage (refrigerant leakage).
- 4 Clogged expansion valve or strainer.
- 5 Faulty outdoor unit PCB (main).
- 6 Poor compression of compressor.

### Abnormality Judgment:

Continue 2 times in 20 minutes.

### Troubleshooting:



For safety reason and to prevent component breakdown, always switch off the power before remove and connect the component.

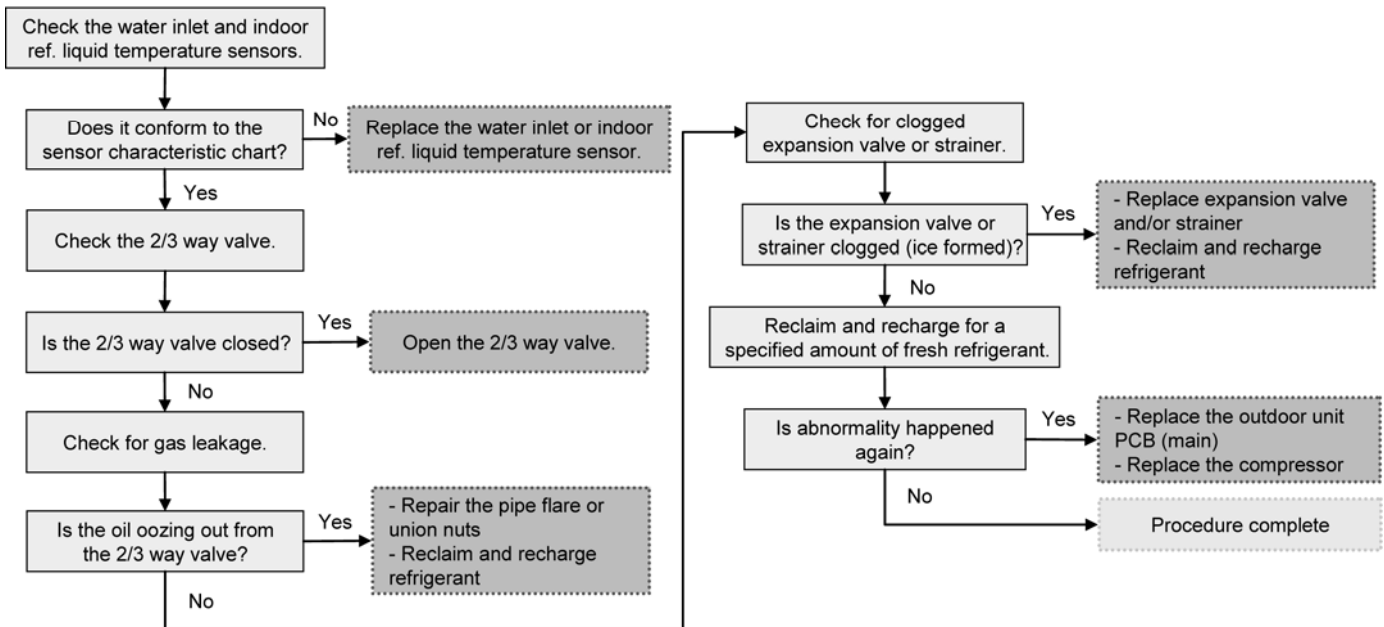

## 17.5.26 Four Way Valve Abnormality (F25)

### Malfunction Decision Conditions:

- 1 During heating operation, when the indoor pipe temperature of thermostat ON indoor unit < 0°C.
- 2 During cooling operation, when the indoor pipe temperature of thermostat ON indoor unit > 45°C.

### Malfunction Caused:

- 1 Faulty sensor.
- 2 Faulty connector connection.
- 3 Faulty outdoor unit PCB (noise filter/main).
- 4 Faulty four way valve.

### Abnormality Judgment:

Continue 4 times in 30 minutes.

### Troubleshooting:



**Caution**

For safety reason and to prevent component breakdown, always switch off the power before remove and connect the component.

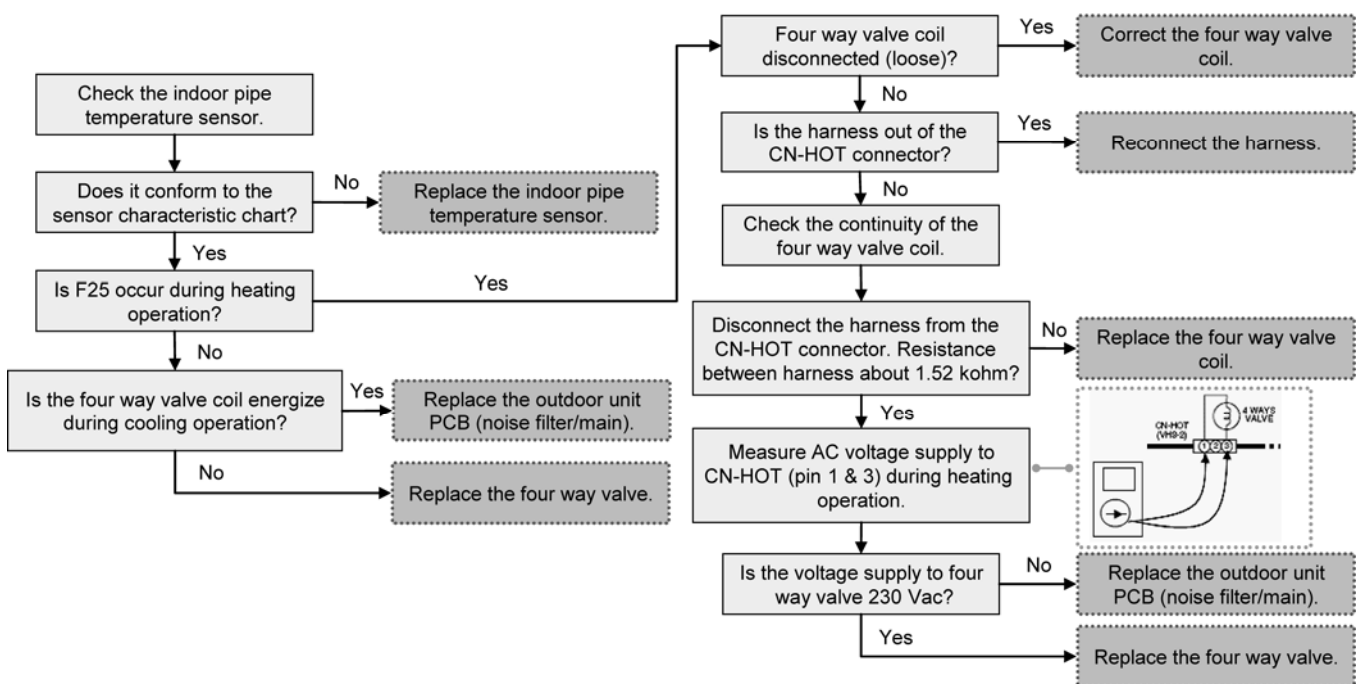

## 17.5.27 Outdoor High Pressure Switch Abnormal (F27)

### Malfunction Decision Conditions:

During compressor stop, and outdoor high pressure switch is remain opened.

### Malfunction Caused:

- 1 Faulty connector connection.
- 2 Faulty switch.
- 3 Faulty outdoor unit PCB (main).

### Abnormality Judgment:

Continue for 1 minute.

## Troubleshooting:



**Caution**

For safety reason and to prevent component breakdown, always switch off the power before remove and connect the component.

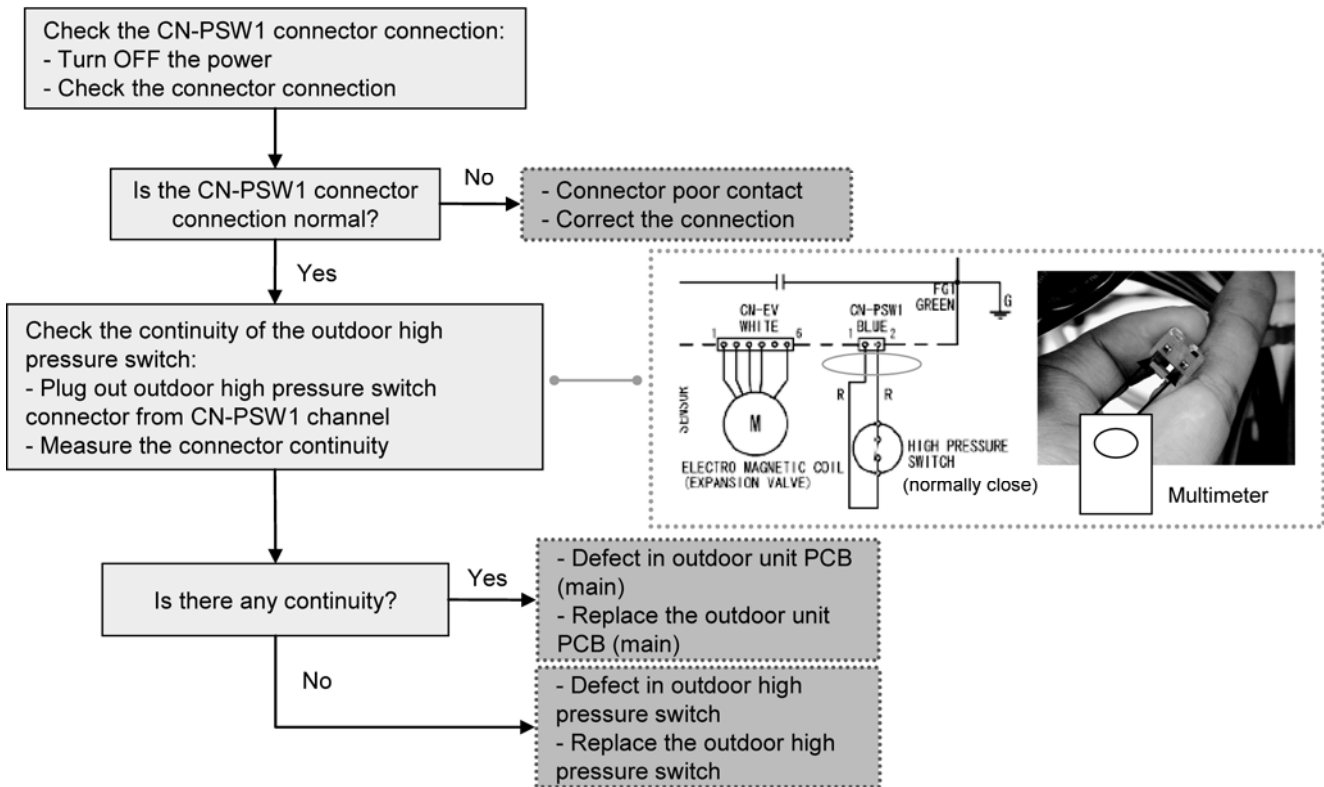



## 17.5.28 Indoor Water Outlet Temperature Sensor 2 Abnormality (F30)

### Malfunction Decision Conditions:

During startup and operation of cooling and heating, the temperatures detected by the indoor water outlet temperature sensor 2 are used to determine sensor error.

### Malfunction Caused:

- 1 Faulty connector connection.
- 2 Faulty sensor.
- 3 Faulty indoor unit PCB.

### Abnormality Judgment:

Continue for 5 seconds.

### Troubleshooting:



**Caution**

For safety reason and to prevent component breakdown, always switch off the power before remove and connect the component.

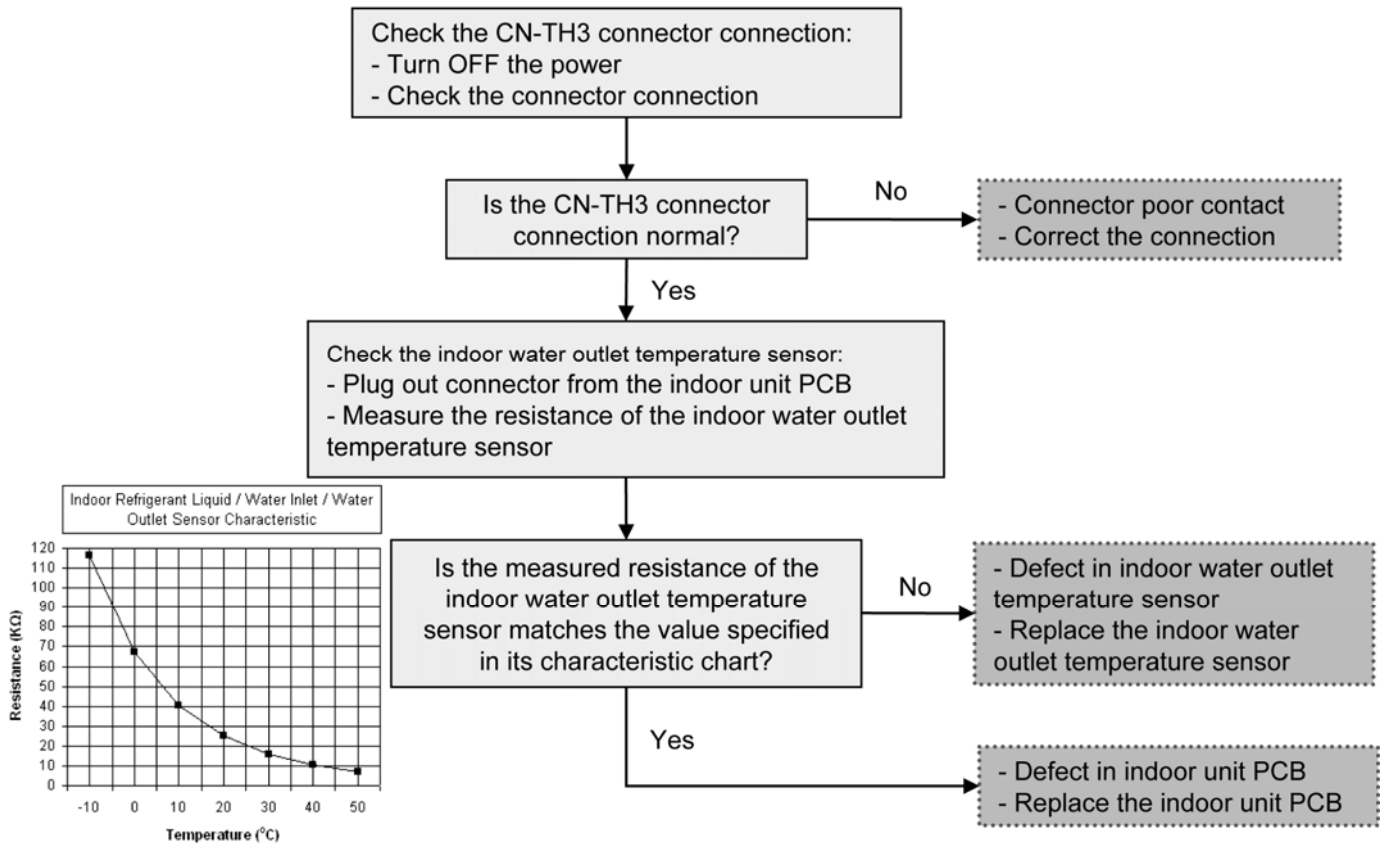

## 17.5.29 Outdoor Air Temperature Sensor Abnormality (F36)

### Malfunction Decision Conditions:

During startup and operation of cooling and heating, the temperatures detected by the outdoor air temperature sensor are used to determine sensor error.

### Malfunction Caused:

- 1 Faulty connector connection.
- 2 Faulty sensor.
- 3 Faulty outdoor unit PCB (main).

### Abnormality Judgment:

Continue for 5 seconds.

### Troubleshooting:



#### Caution

For safety reason and to prevent component breakdown, always switch off the power before remove and connect the component.

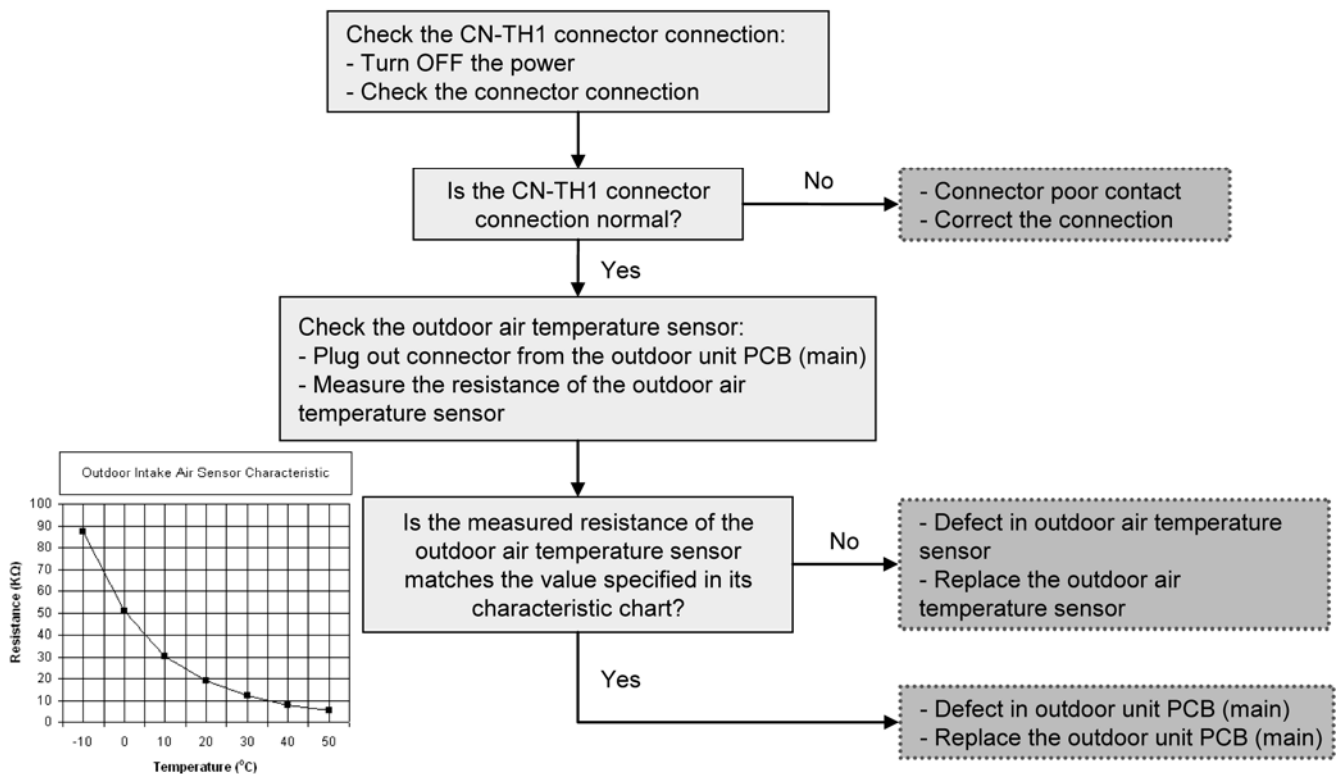

### 17.5.30 Indoor Water Inlet Temperature Sensor Abnormality (F37)

**Malfunction Decision Conditions:**

During startup and operation of cooling and heating, the temperatures detected by the indoor water inlet temperature sensor are used to determine sensor error.

**Malfunction Caused:**

- 1 Faulty connector connection.
- 2 Faulty sensor.
- 3 Faulty indoor unit PCB (main).

**Abnormality Judgment:**

Continue for 5 seconds.

**Troubleshooting:**



**Caution**

For safety reason and to prevent component breakdown, always switch off the power before remove and connect the component.

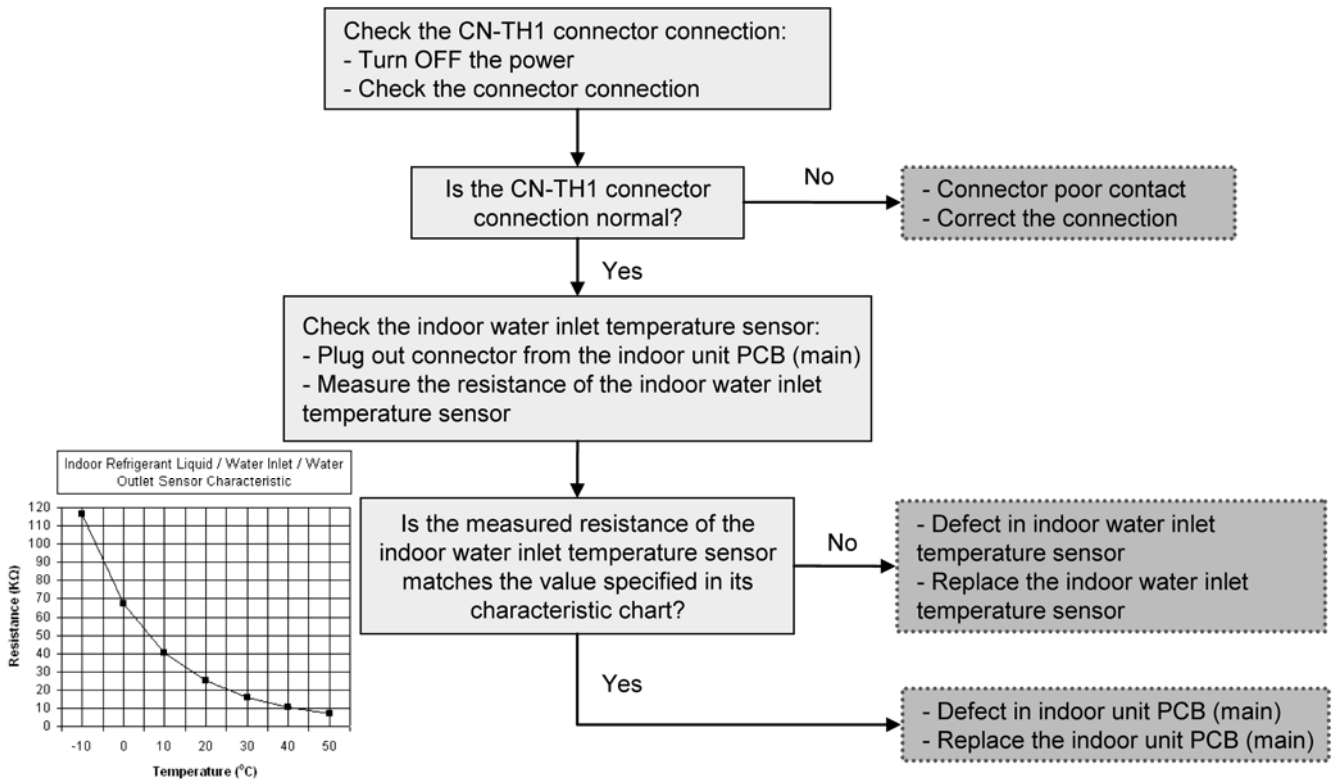

## 17.5.31 Outdoor Discharge Pipe Temperature Sensor Abnormality (F40)

### Malfunction Decision Conditions:

During startup and operation of cooling and heating, the temperatures detected by the outdoor discharge pipe temperature sensor are used to determine sensor error.

### Malfunction Caused:

- 1 Faulty connector connection.
- 2 Faulty sensor.
- 3 Faulty outdoor unit PCB (main).

### Abnormality Judgment:

Continue for 5 seconds.

### Troubleshooting:



**Caution**

For safety reason and to prevent component breakdown, always switch off the power before remove and connect the component.

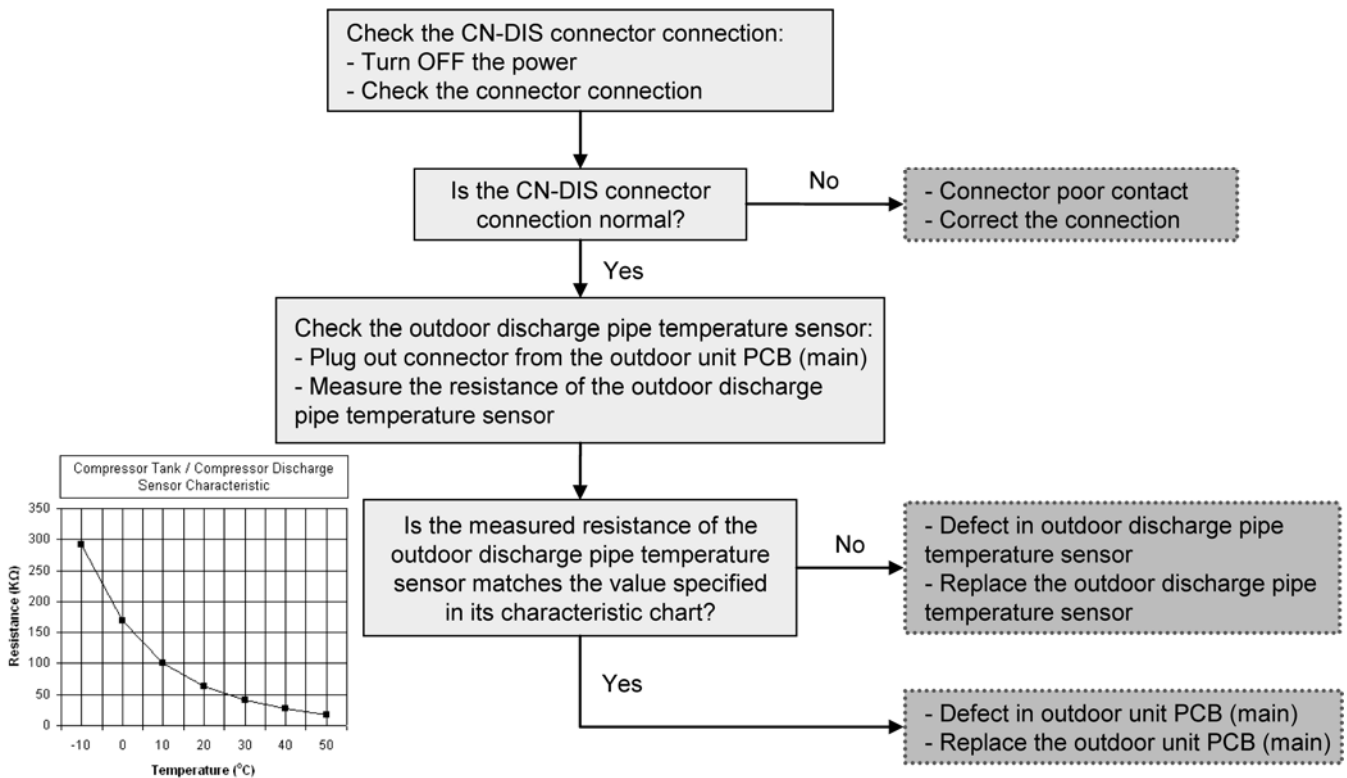

### 17.5.32 Power Factor Correction (PFC) Abnormality (F41)

**Malfunction Decision Conditions:**

During operation of cooling and heating, when the PFC protection circuitry in the outdoor unit PCB (main) senses abnormal high DC voltage level.

**Malfunction Caused:**

- 1 Power supply surge.
- 2 Compressor windings not uniform.
- 3 Faulty outdoor unit PCB (main).

**Abnormality Judgment:**

Continue 4 times in 10 minutes.

**Troubleshooting:**



**Caution**

For safety reason and to prevent component breakdown, always switch off the power before remove and connect the component.

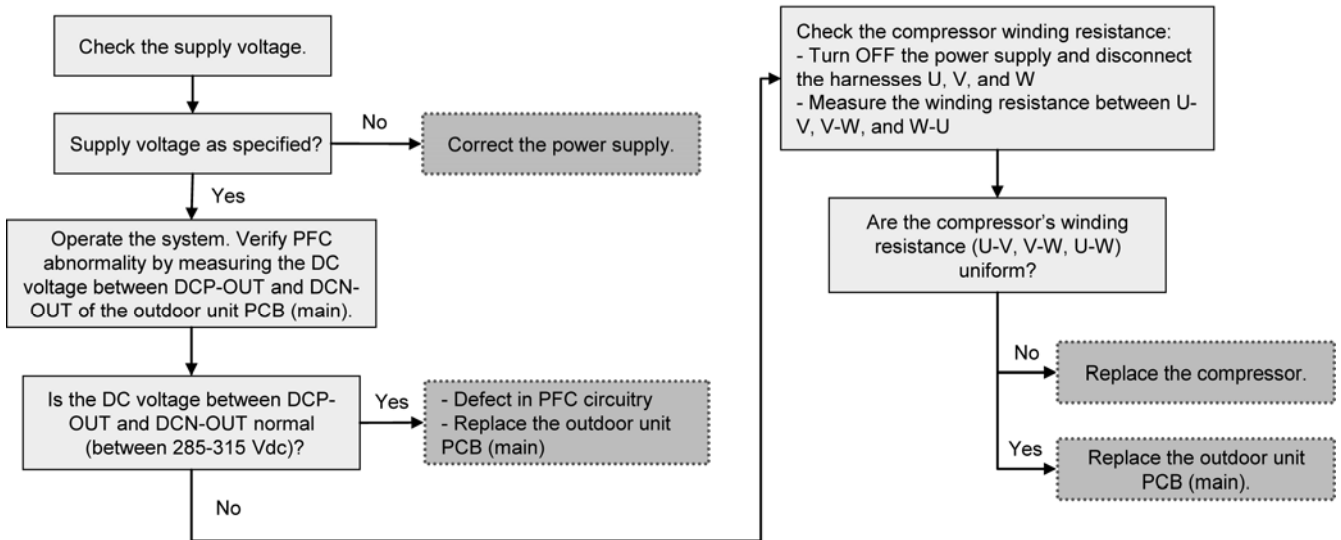

### 17.5.33 Outdoor Pipe Temperature Sensor Abnormality (F42)

#### Malfunction Decision Conditions:

During startup and operation of cooling and heating, the temperatures detected by the outdoor pipe temperature sensor are used to determine sensor error.

#### Malfunction Caused:

- 1 Faulty connector connection.
- 2 Faulty sensor.
- 3 Faulty outdoor unit PCB (main).

#### Abnormality Judgment:

Continue for 5 seconds.

#### Troubleshooting:



**Caution**

For safety reason and to prevent component breakdown, always switch off the power before remove and connect the component.

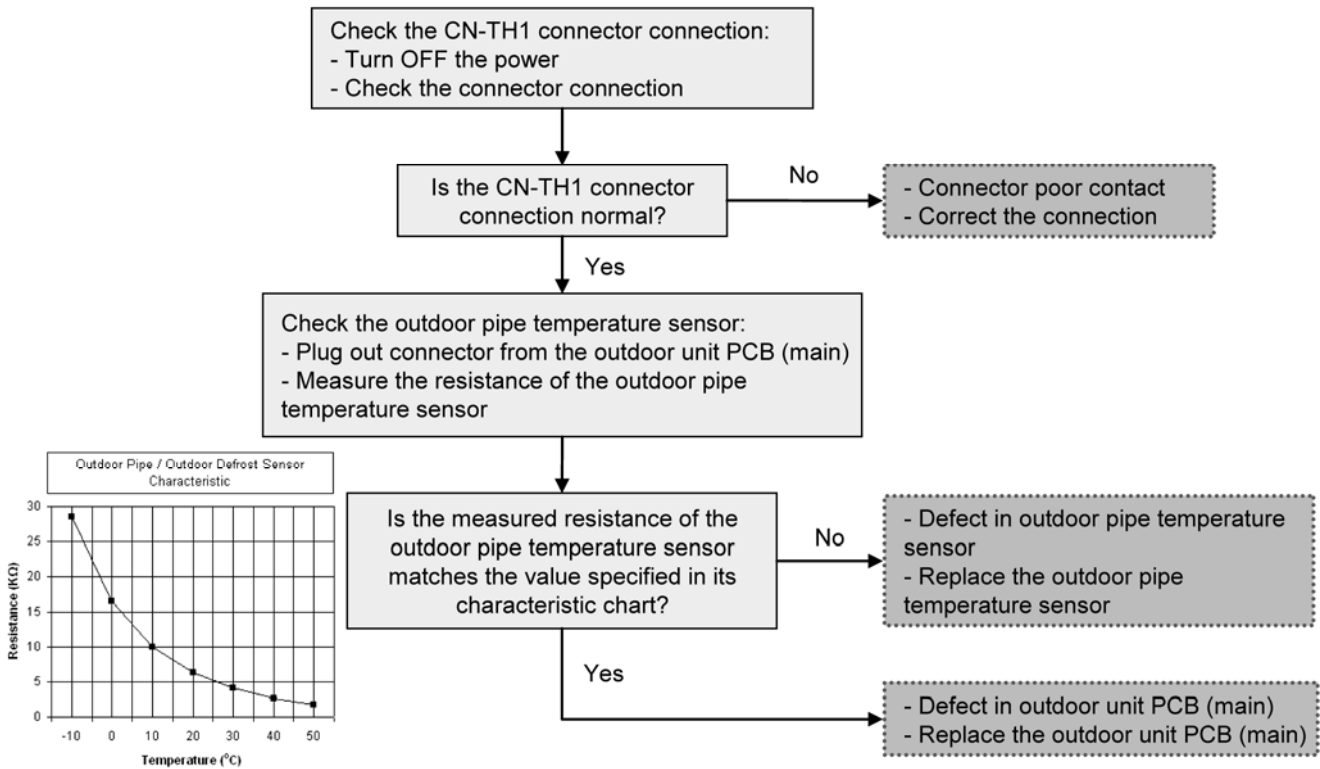

### 17.5.34 Outdoor Defrost Temperature Sensor Abnormality (F43)

**Malfunction Decision Conditions:**

During startup and operation of cooling and heating, the temperatures detected by the outdoor defrost temperature sensor are used to determine sensor error.

**Malfunction Caused:**

- 1 Faulty connector connection.
- 2 Faulty sensor.
- 3 Faulty outdoor unit PCB (main).

**Abnormality Judgment:**

Continue for 5 seconds.

**Troubleshooting:**



**Caution**

For safety reason and to prevent component breakdown, always switch off the power before remove and connect the component.

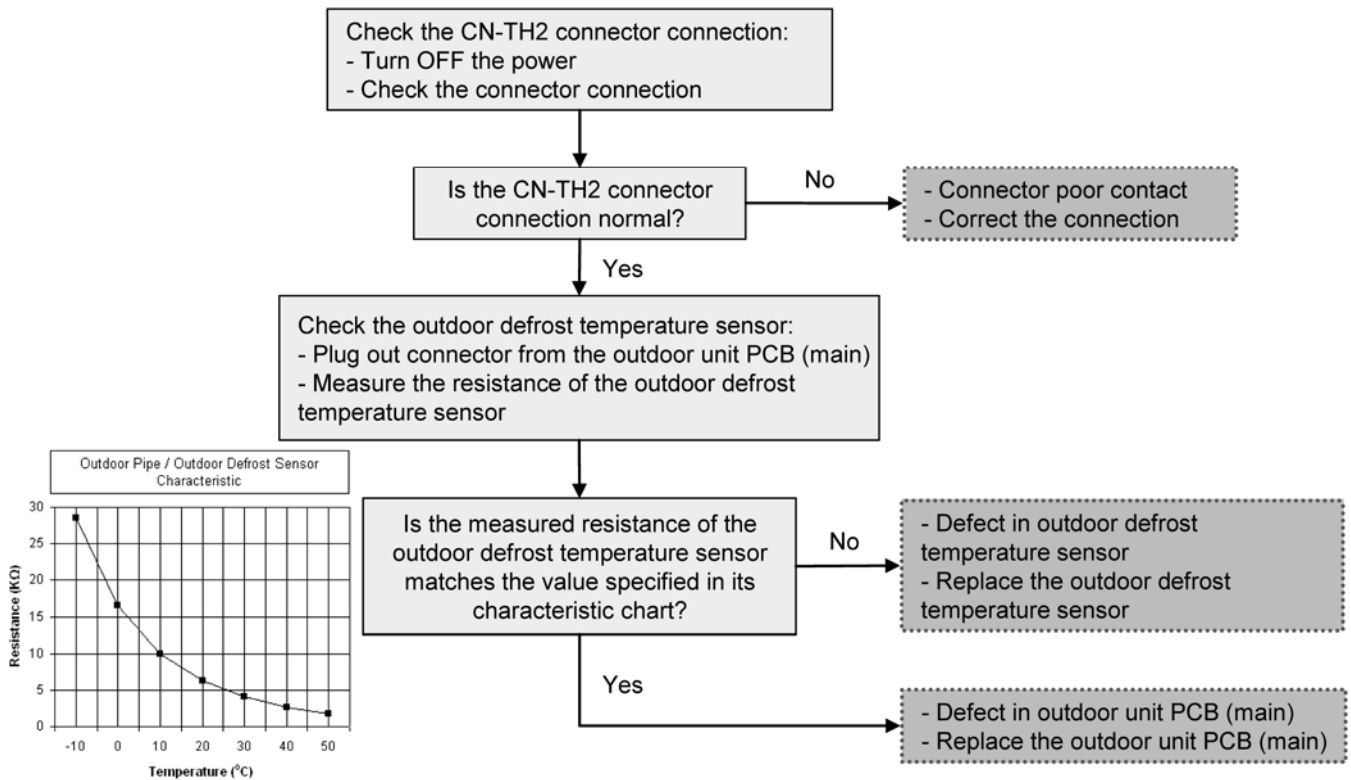

## 17.5.35 Indoor Water Outlet Temperature Sensor Abnormality (F45)

### Malfunction Decision Conditions:

During startup and operation of cooling and heating, the temperatures detected by the indoor water outlet temperature sensor are used to determine sensor errors.

### Malfunction Caused:

- 1 Faulty connector connection.
- 2 Faulty sensor.
- 3 Faulty indoor unit PCB (main).

### Abnormality Judgment:

Continue for 5 seconds.

### Troubleshooting:



**Caution**

For safety reason and to prevent component breakdown, always switch off the power before remove and connect the component.

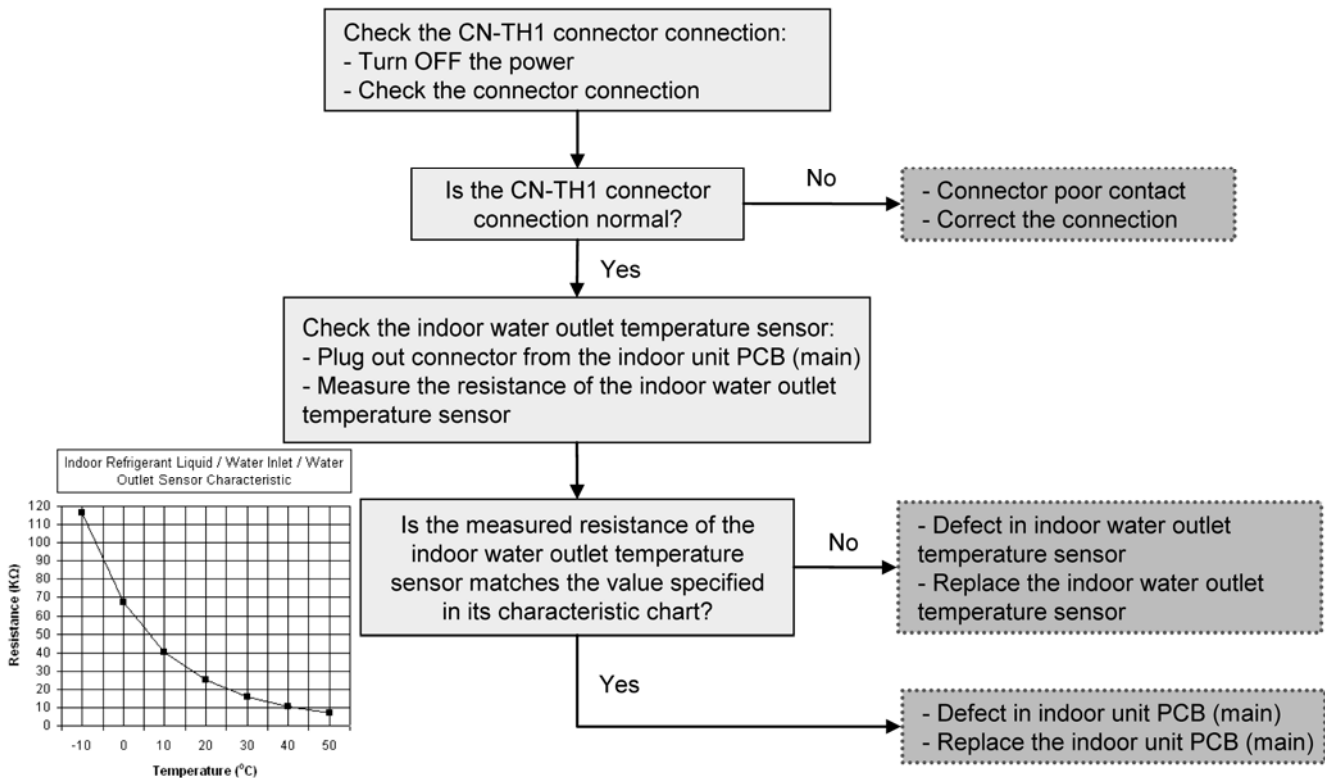



### 17.5.36 Outdoor Current Transformer Open Circuit (F46)

**Malfunction Decision Conditions:**

A current transformer (CT) open circuit is detected by checking the compressor running frequency ( $\geq$  rated frequency) and CT detected input current ( $< 0.65$  A) for continuously 20 seconds.

**Malfunction Caused:**

- 1 CT defective.
- 2 Faulty outdoor unit PCB (main).
- 3 Compressor defective (low compression).

**Abnormality Judgment:**

Continue 3 times in 20 minutes.

**Troubleshooting:**



**Caution**

For safety reason and to prevent component breakdown, always switch off the power before remove and connect the component.

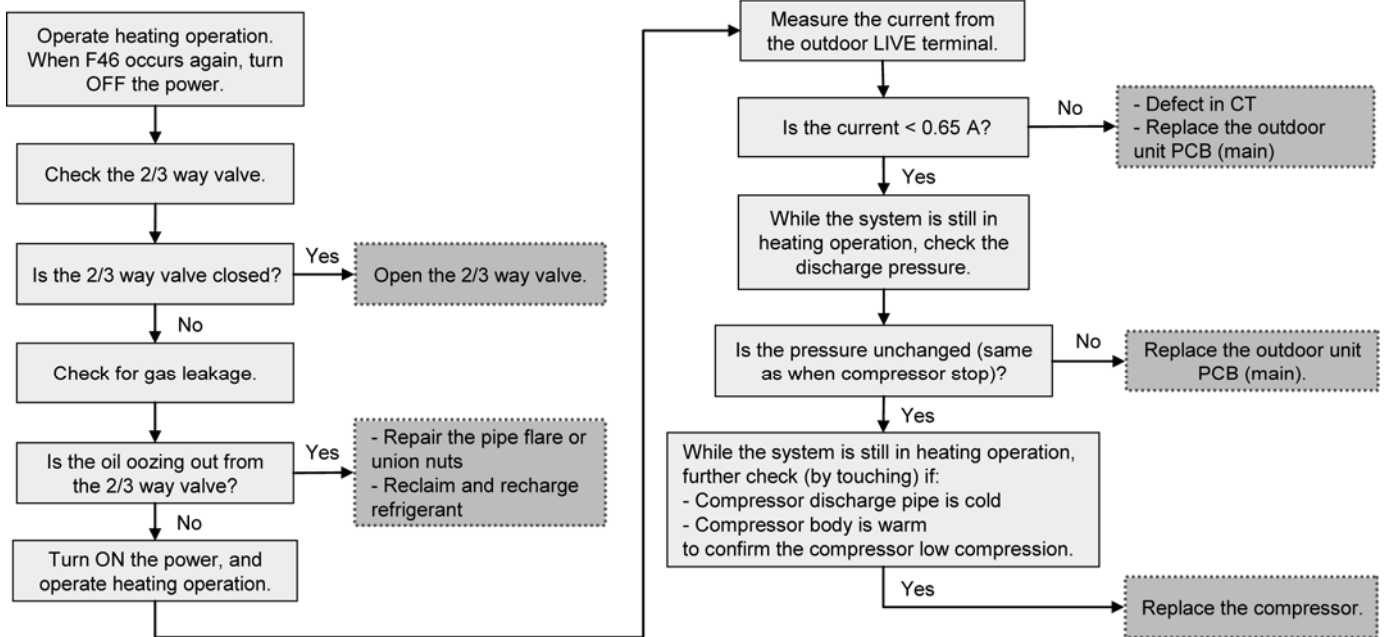

## 17.5.37 Cooling High Pressure Overload Protection (F95)

### Malfunction Decision Conditions:

During operation of cooling, when pressure 4.0 MPa and above is detected by outdoor high pressure sensor.

### Malfunction Caused:

- 1 Dust accumulation in the outdoor unit heat exchanger.
- 2 Air short circuit at outdoor unit.
- 3 2 way valve closed.
- 4 Faulty outdoor unit fan motor.
- 5 Clogged expansion valve or strainer.
- 6 Excessive refrigerant.
- 7 Faulty outdoor high pressure sensor.
- 8 Faulty outdoor unit PCB (main).

### Troubleshooting:



**Caution**

For safety reason and to prevent component breakdown, always switch off the power before remove and connect the component.

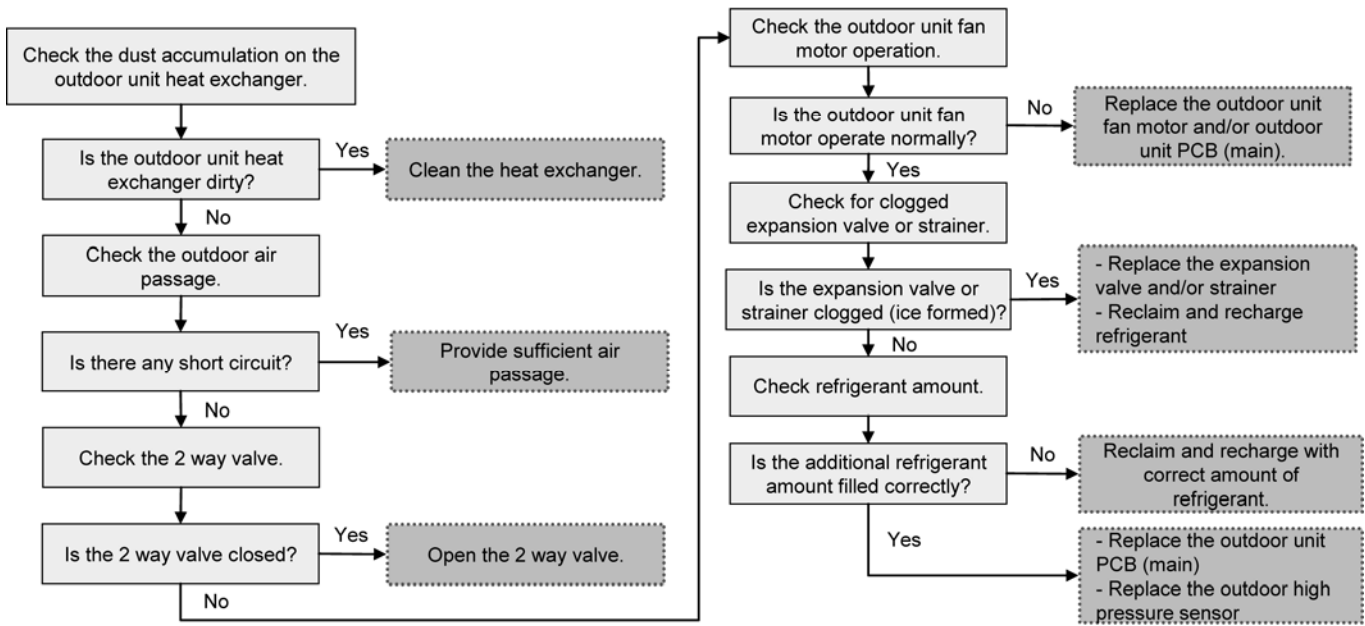

## 18. Disassembly and Assembly Instructions



### WARNING

High Voltage are generated in the electrical parts area by the capacitor. Ensure that the capacitor has discharged sufficiently before proceeding with repair work. Failure to heed this caution may result in electric shocks.

### 18.1 To Remove Front Plate

Please follow the steps below for take out front plate. Before removing the front plate of indoor unit, always switch off all power supply (i.e. indoor unit power supply, heater power supply and boiler tank power supply).

- 1 Remove the 2 mounting screws which located at bottom of the front plate and 1 mounting screw at the front of the plate.
- 2 Gently pull the lower section of the front plate towards you to remove the front plate from left and right hooks.
- 3 Hold the left edge and right edge of front plate to lift up front plate from hooks.

When reinstalling the front plate, first set the 2 hooks, which located at the top of front plate, into the slots at cabinet. Then carry out above steps in the reverse order.

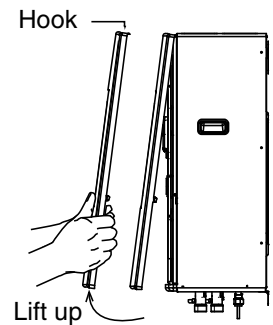
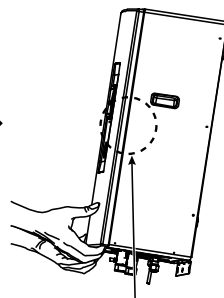
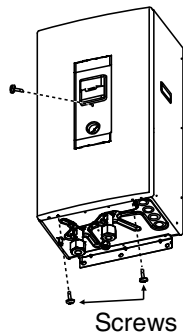

Fix the left and right hooks to cabinet slot properly when reinstall front plate.

### 18.2 To Remove Cabinet

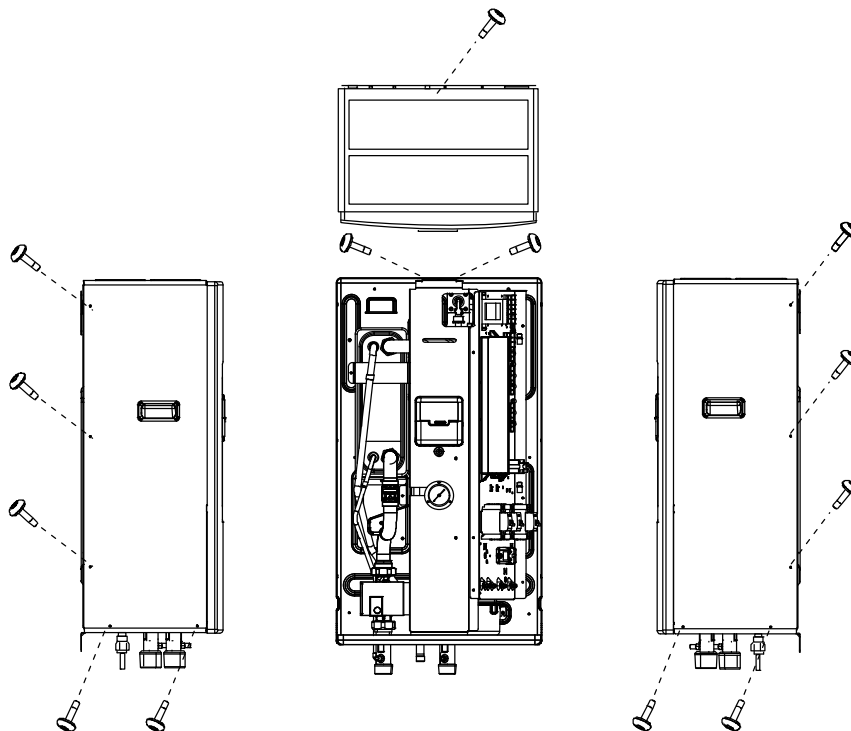

- 1 Remove the 13 mounting screws on the left, right and top side of the cabinet.
- 2 Gently remove the side cabinet by holding both of the handles.

### 18.3 To Remove Pressure Gauge

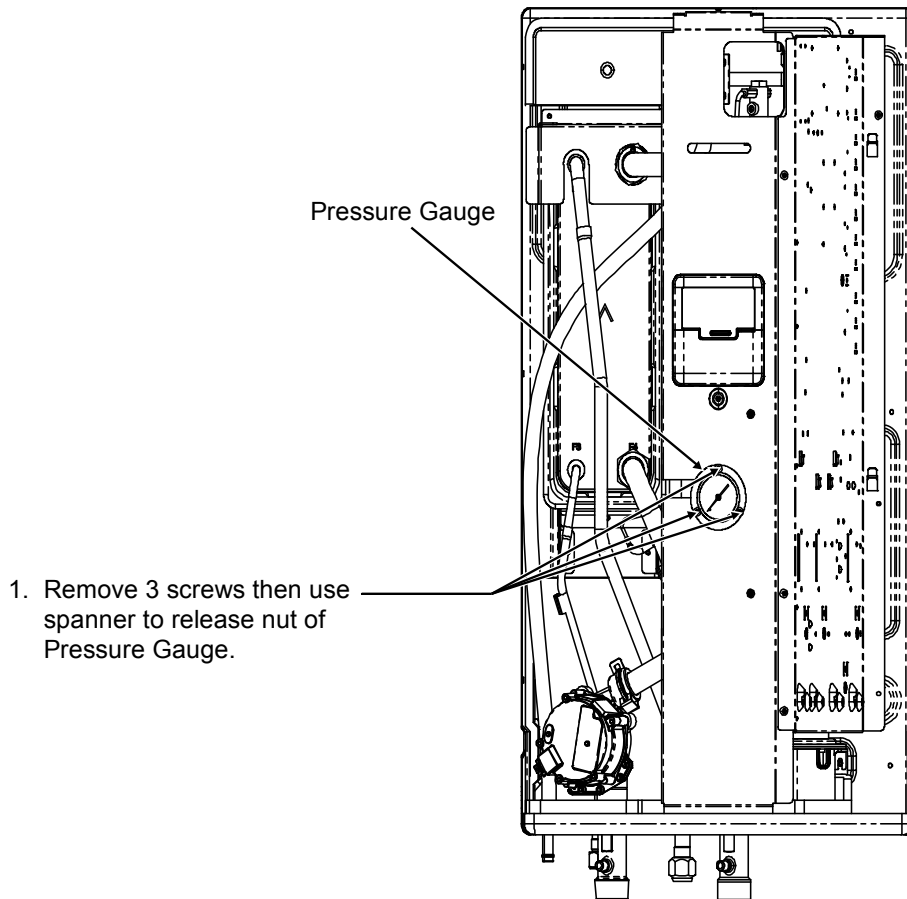

### 18.4 To Remove Control Panel

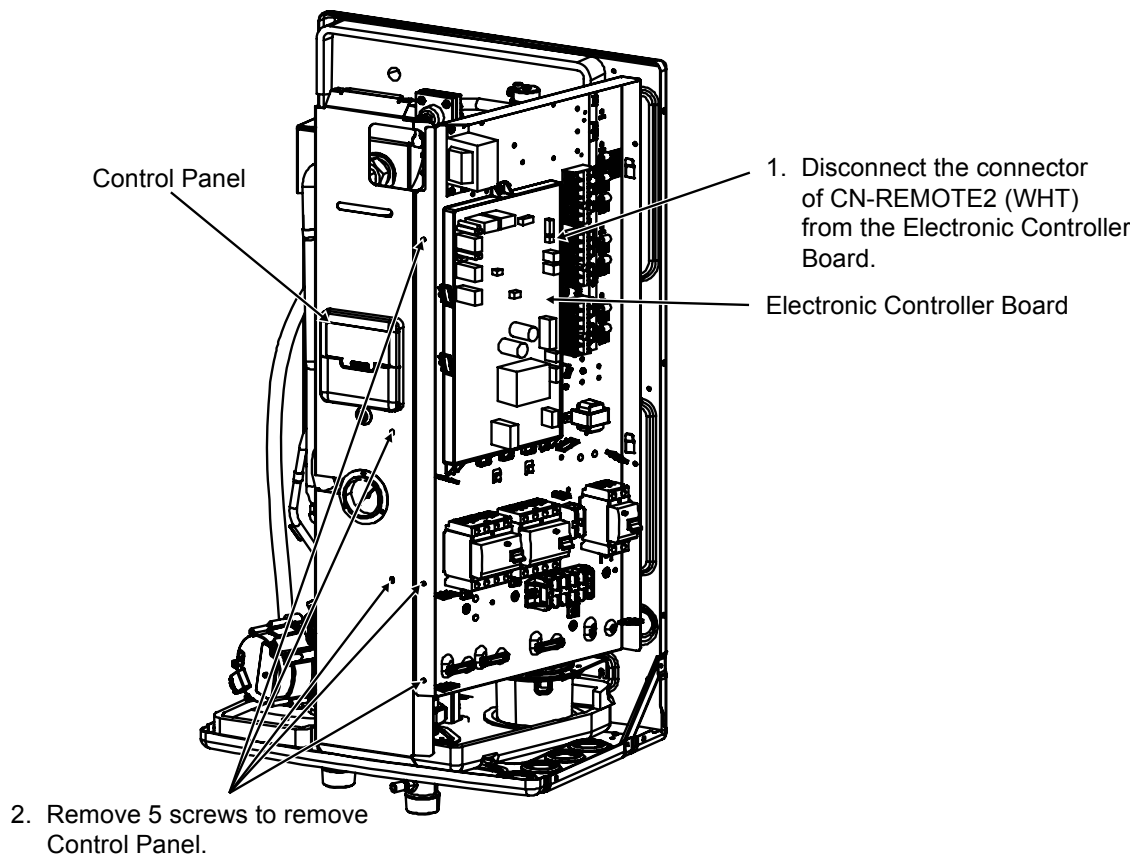

## 18.5 To Remove RCCB

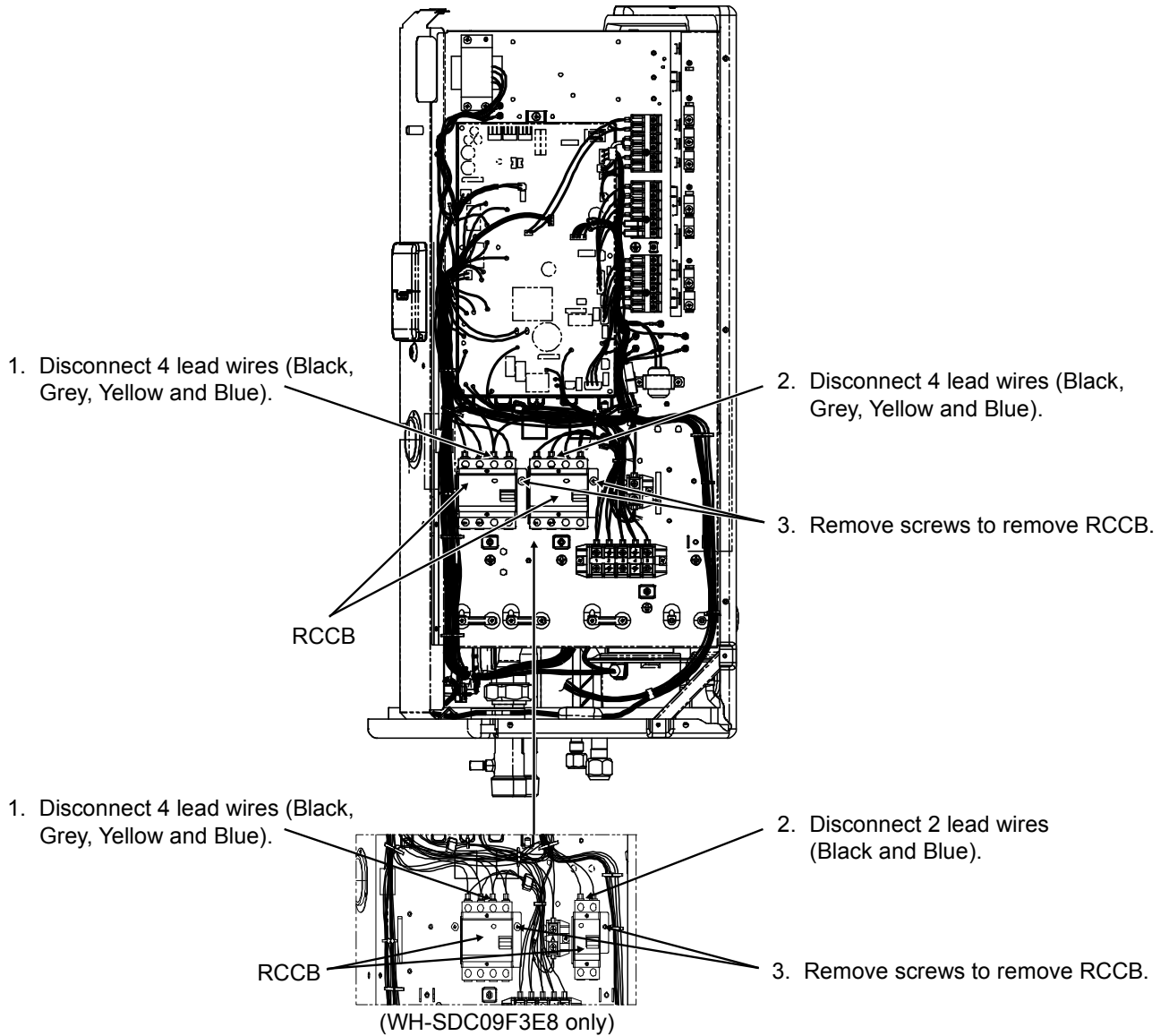

## 18.6 To Remove Transformer and Electronic Controller Board

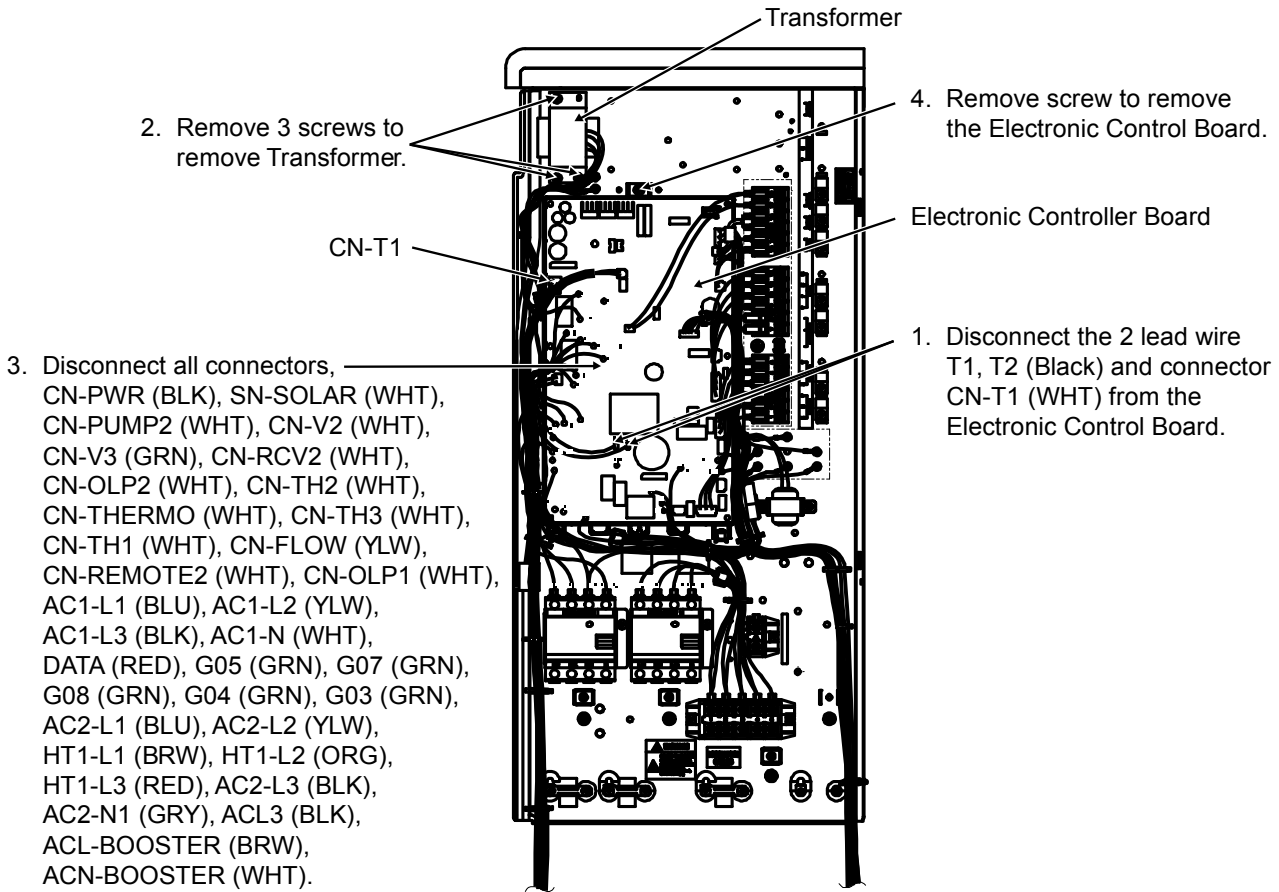

## 18.7 To Remove Pressure Relief Valve, Flow Switch and Air Purge Valve

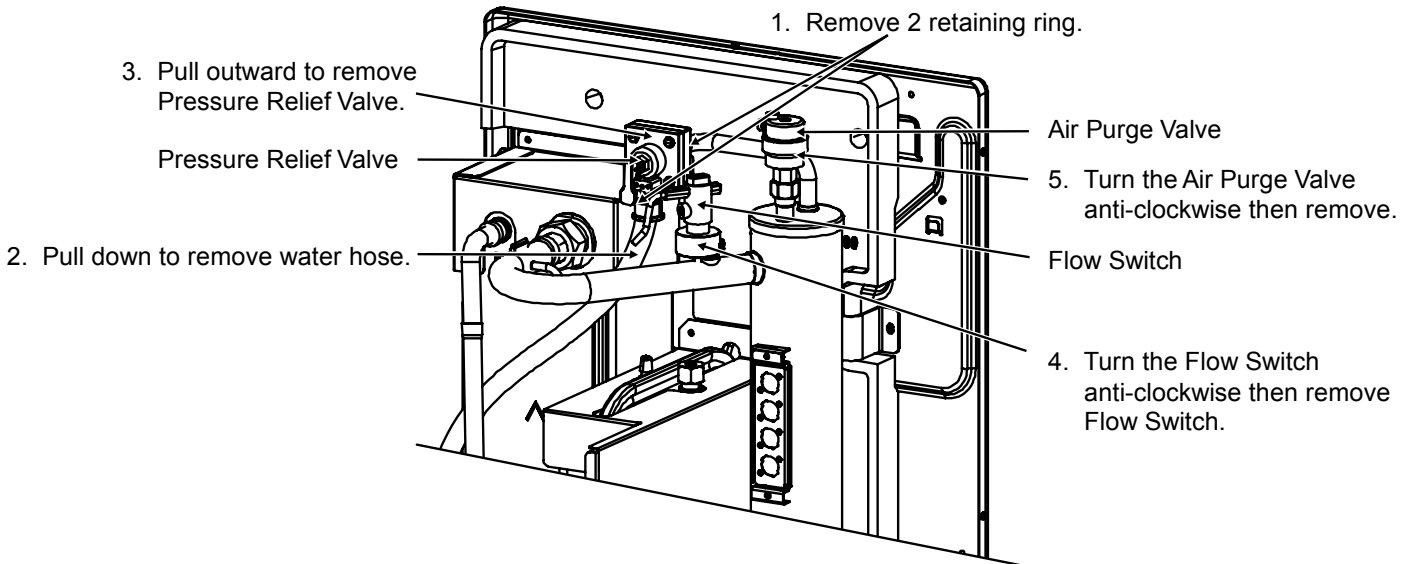

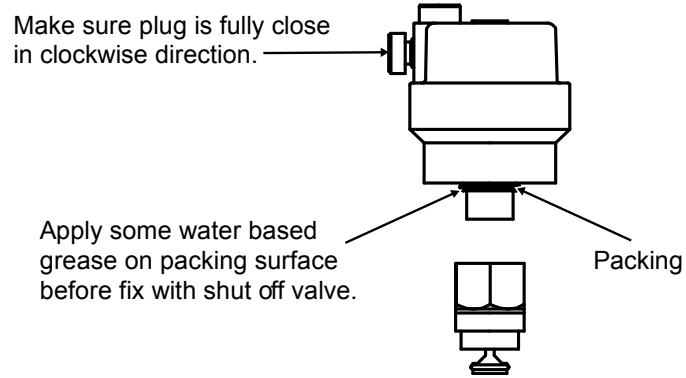

**!** When reinstall Flow Switch, ensure the arrow on the flow switch is parallel with the pipe shaft and is facing in the direction of flow.

 During reinstall Air Purge Valve.

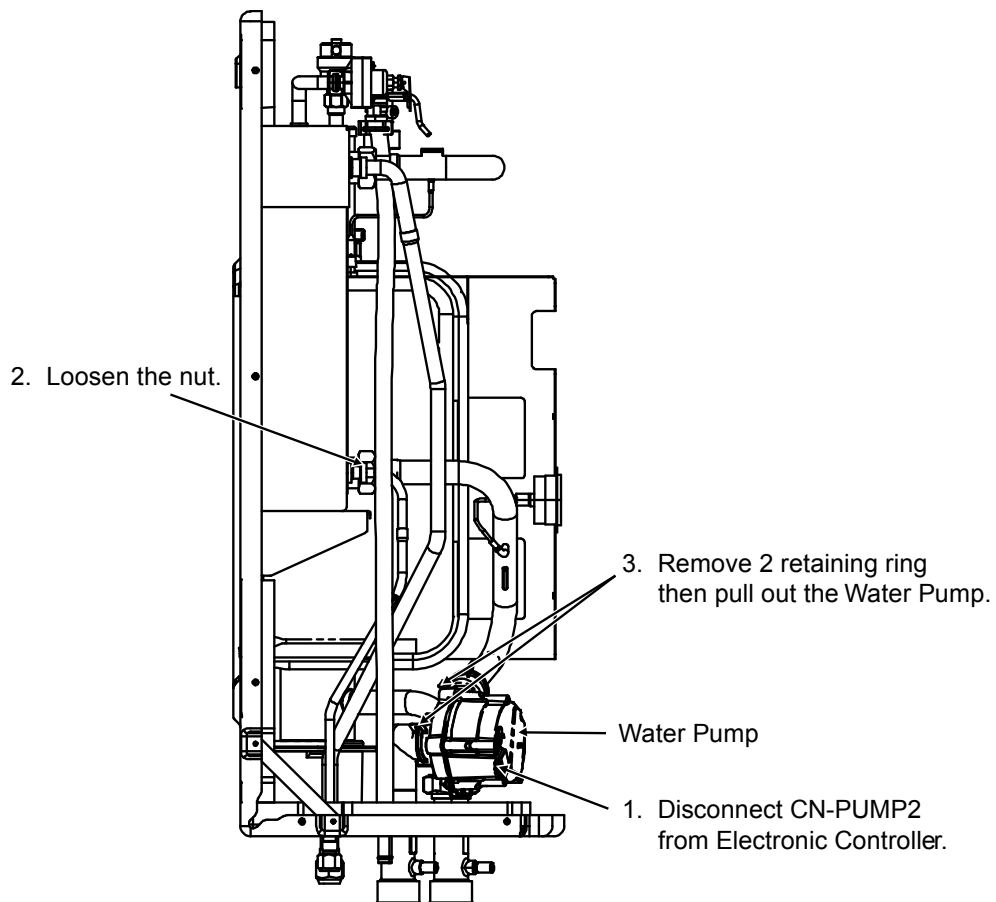

### 18.8 To Remove Water Pump and Bottle Complete



 When reinstall the water pipe, use grease or water at the joining.

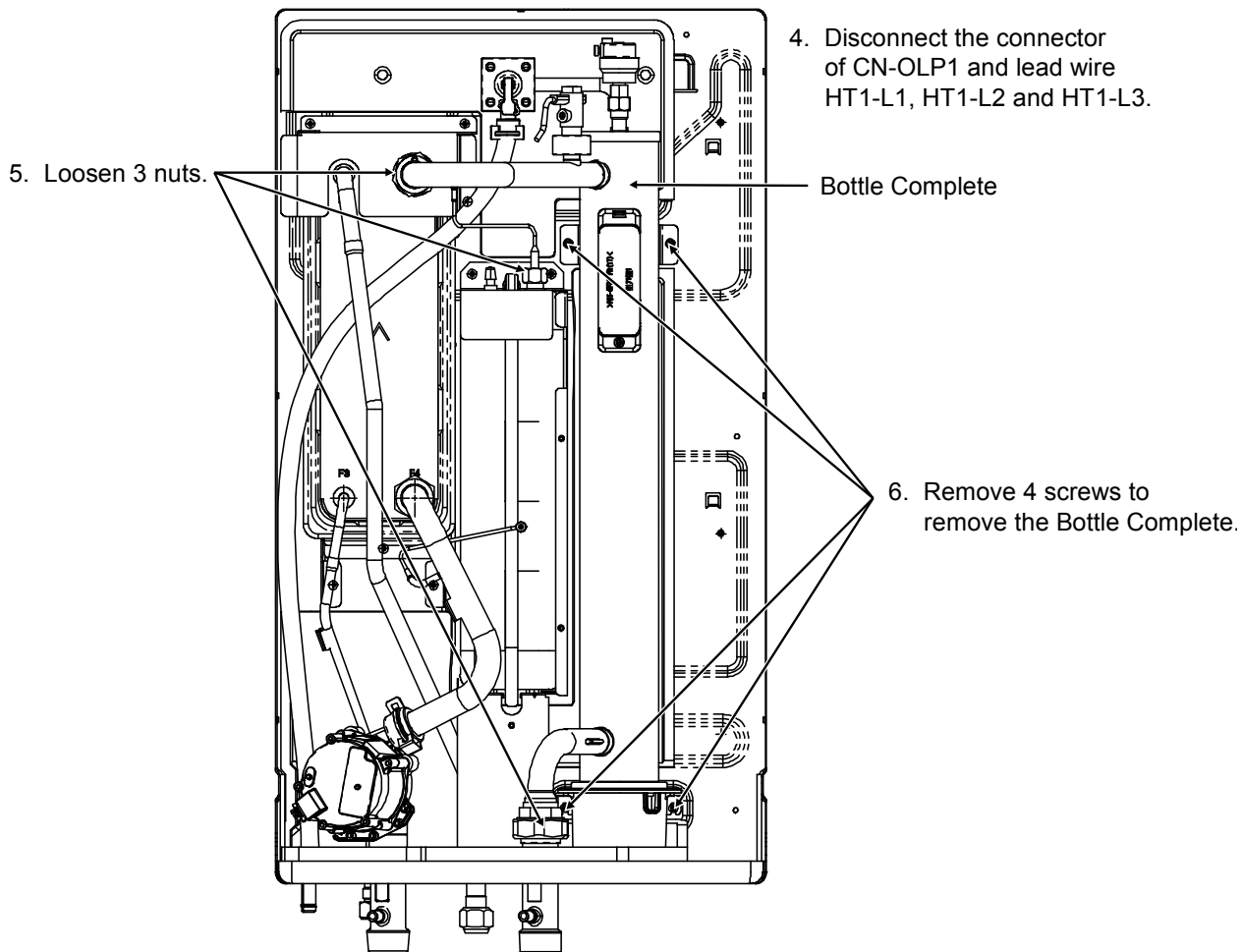

 When reinstall the water pipe, use grease or water at the joining.



# 19. Technical Data

## 19.1 Operation Characteristics

### 19.1.1 WH-SDC09F3E8 WH-UD09FE8

#### Heating Characteristics at Different Outdoor Air Temperature

Condition

Outdoor air temperature : 7°C (DBT), 6°C (WBT)

Indoor water inlet temperature : 30°C

Indoor water outlet temperature : 35°C

Piping length : 7 m

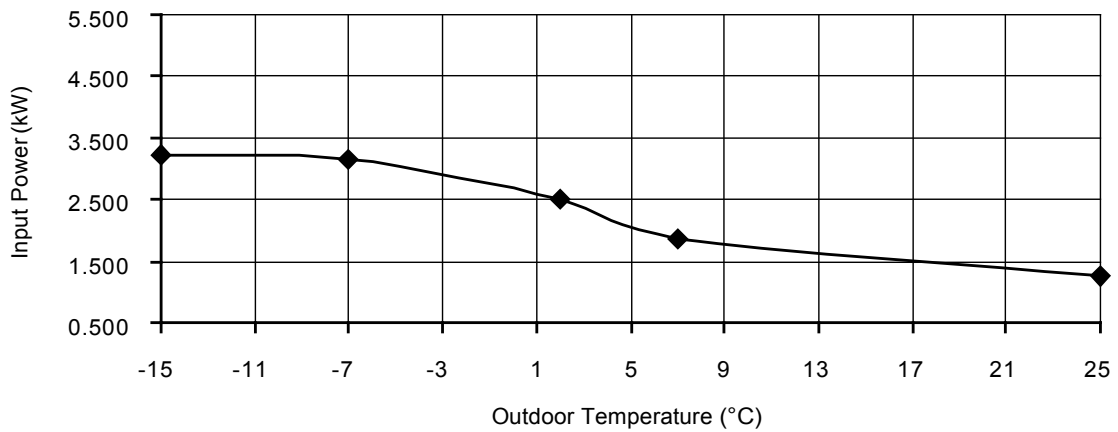
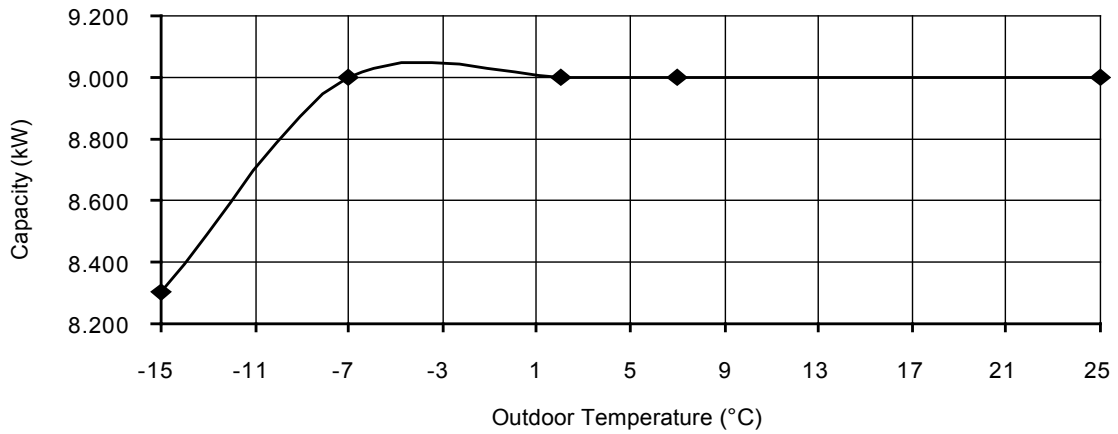

### Cooling Characteristics at Different Outdoor Air Temperature

Condition

Outdoor air temperature : 35°C (DBT), -°C (WBT)

Indoor water inlet temperature : 12°C

Indoor water outlet temperature : 7°C

Piping length : 7 m

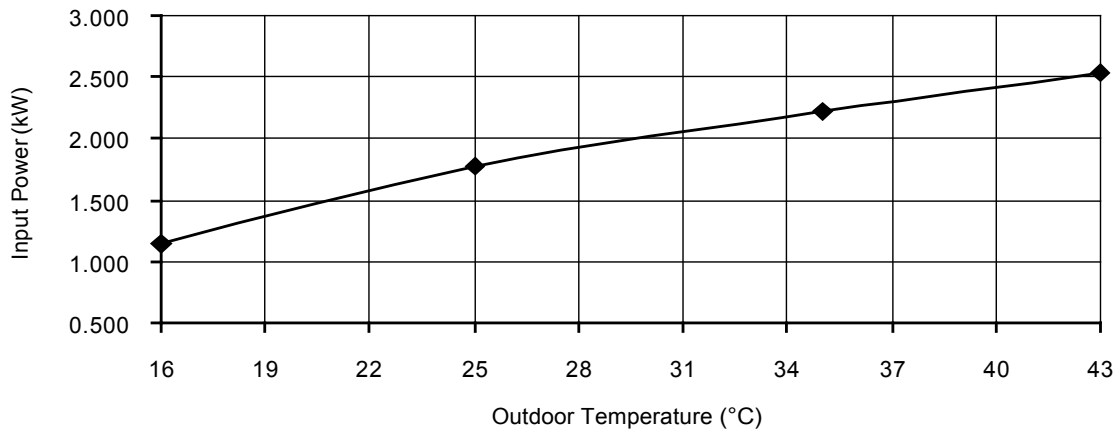
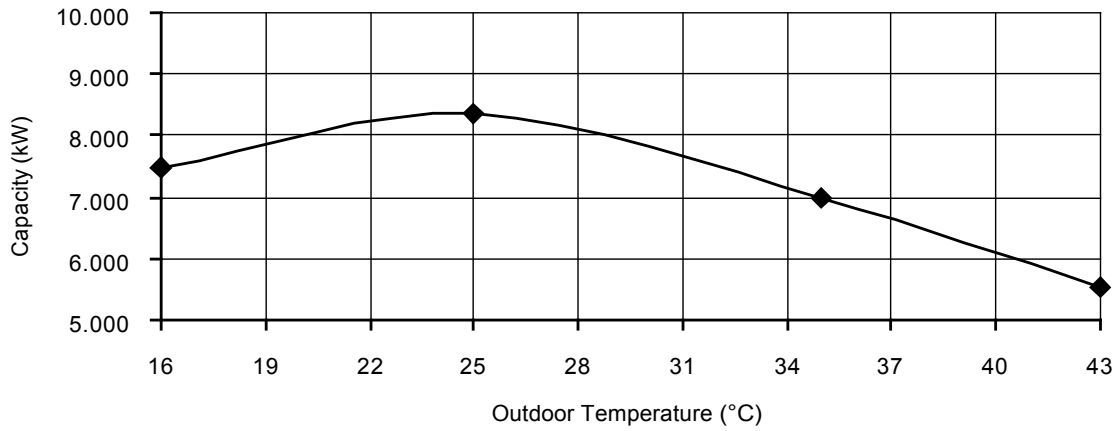

### Cooling Characteristics at Different Outdoor Air Temperature

Condition

Outdoor air temperature : 35°C (DBT), -°C (WBT)

Indoor water inlet temperature : 19°C

Indoor water outlet temperature : 14°C

Piping length : 7 m

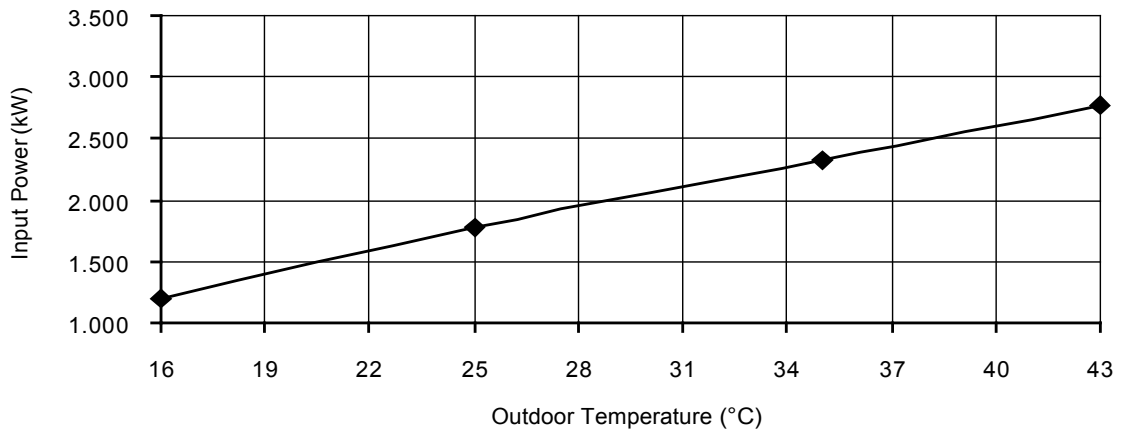
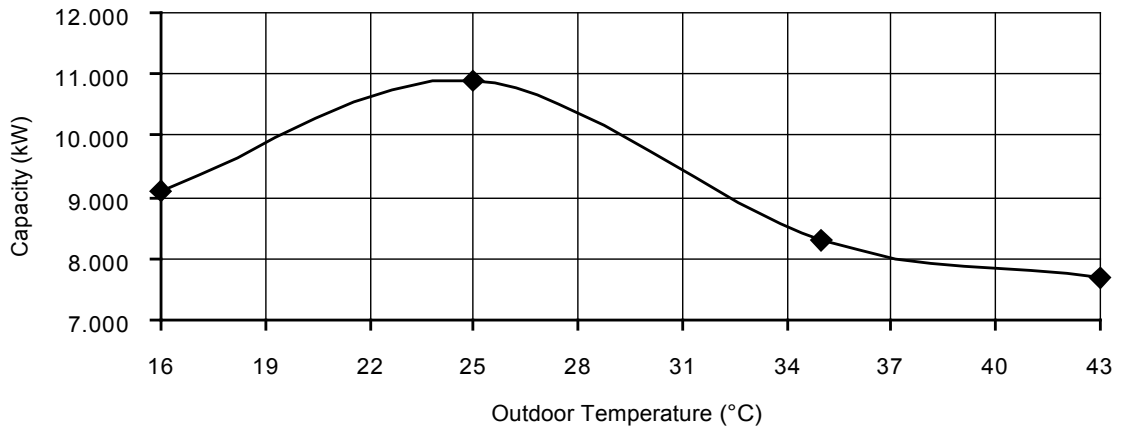

### Cooling Characteristics at Different Outdoor Air Temperature

Condition

Outdoor air temperature : 35°C (DBT), -°C (WBT)

Indoor water inlet temperature : 23°C

Indoor water outlet temperature : 18°C

Piping length : 7 m

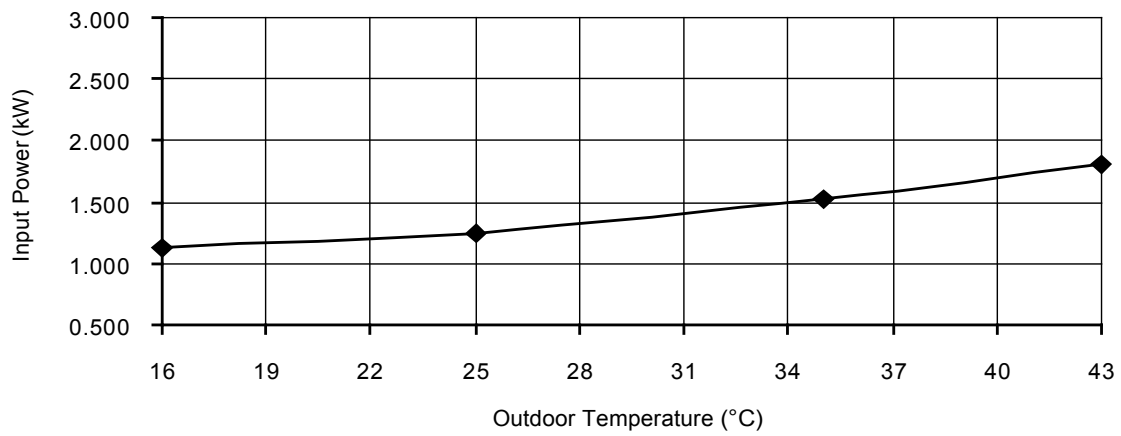
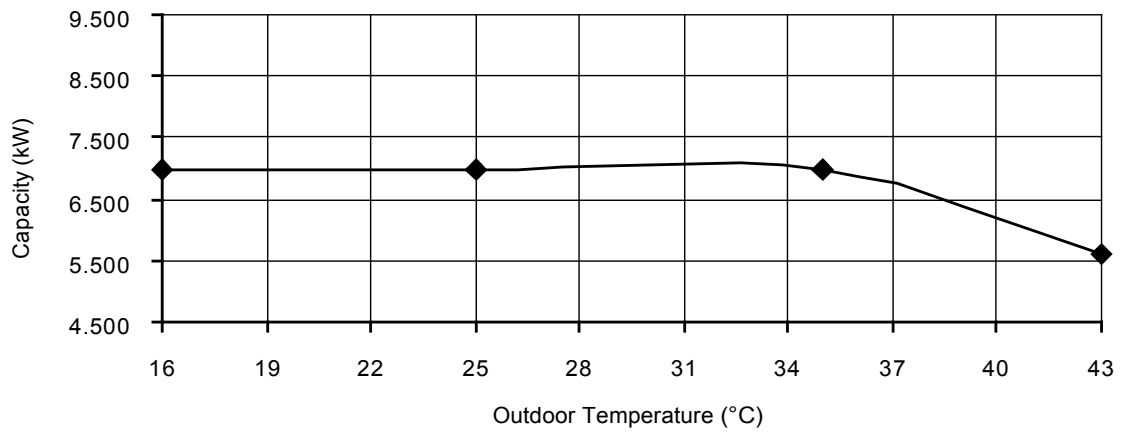

### Heating Characteristics at Different Piping Length

Condition

Outdoor air temperature : 7°C (DBT), 6°C (WBT)

Indoor water inlet temperature : 30°C

Indoor water outlet temperature : 35°C

Piping length : 7 m

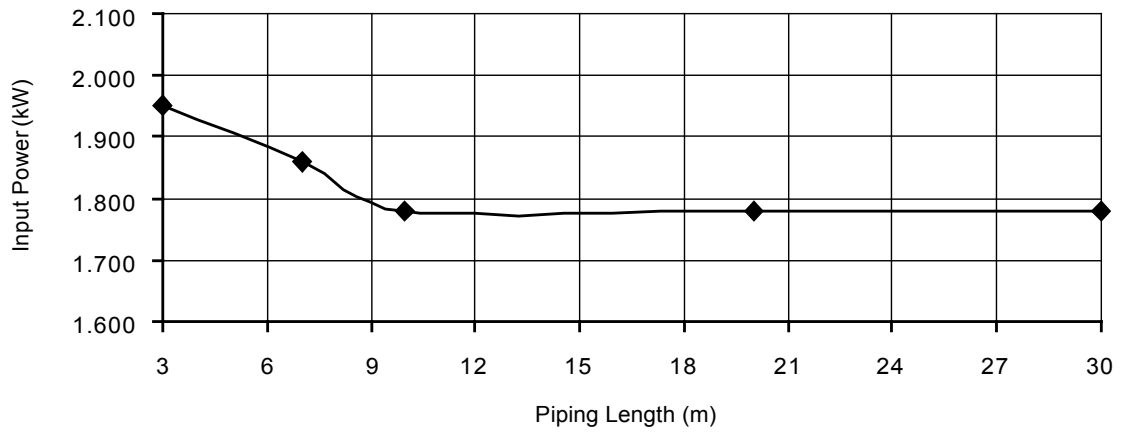
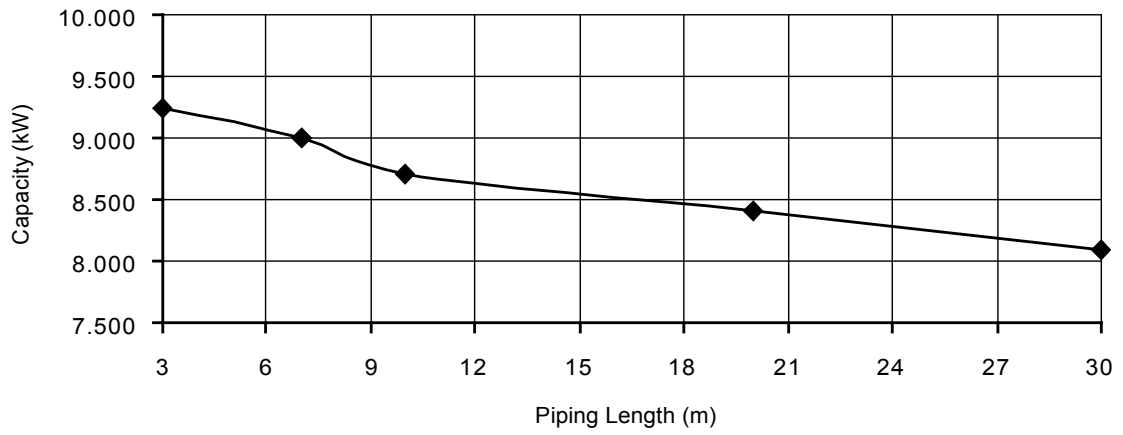

### Cooling Characteristics at Different Piping Length

Condition

Outdoor air temperature : 35°C (DBT), -°C (WBT)

Indoor water inlet temperature : 12°C

Indoor water outlet temperature : 7°C

Piping length : 7 m

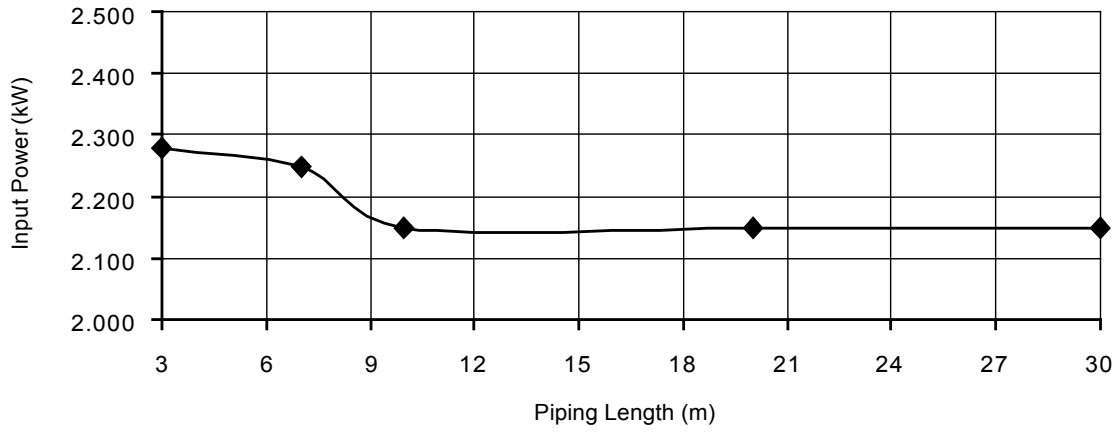
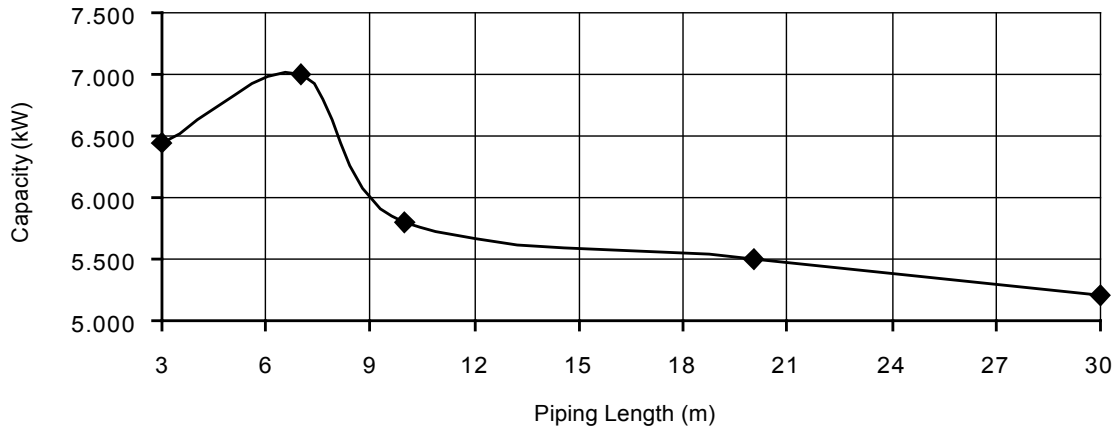

## 19.1.2 WH-SDC12F9E8 WH-UD12FE8

### Heating Characteristics at Different Outdoor Air Temperature

Condition

Outdoor air temperature : 7°C (DBT), 6°C (WBT)

Indoor water inlet temperature : 30°C

Indoor water outlet temperature : 35°C

Piping length : 7 m

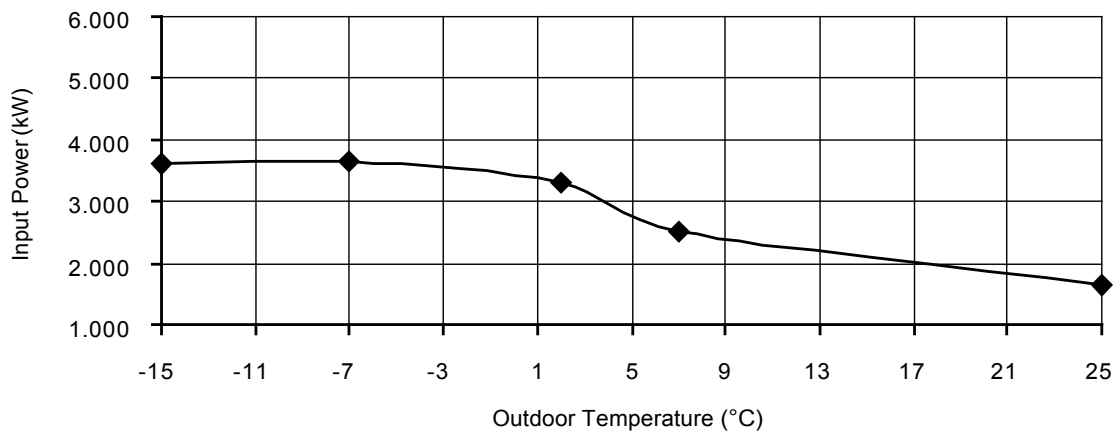
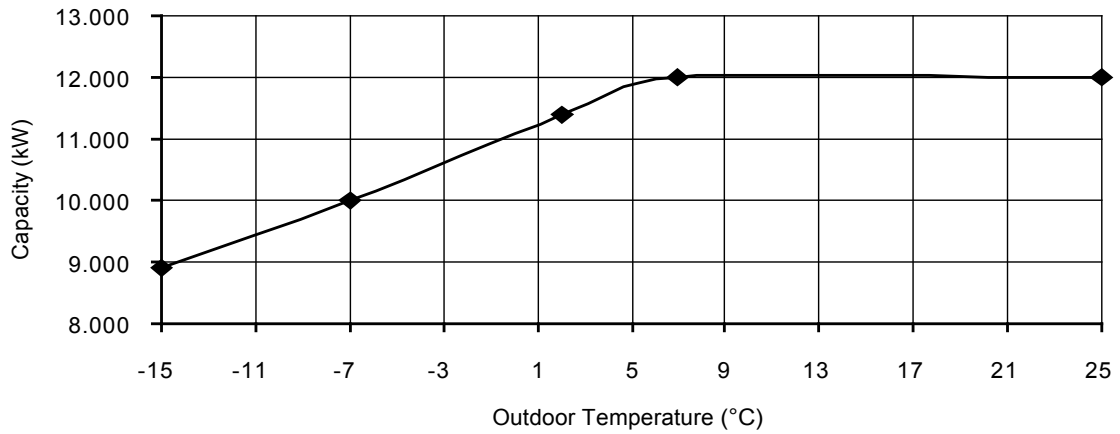

### Cooling Characteristics at Different Outdoor Air Temperature

Condition

Outdoor air temperature : 35°C (DBT), -°C (WBT)

Indoor water inlet temperature : 12°C

Indoor water outlet temperature : 7°C

Piping length : 7 m

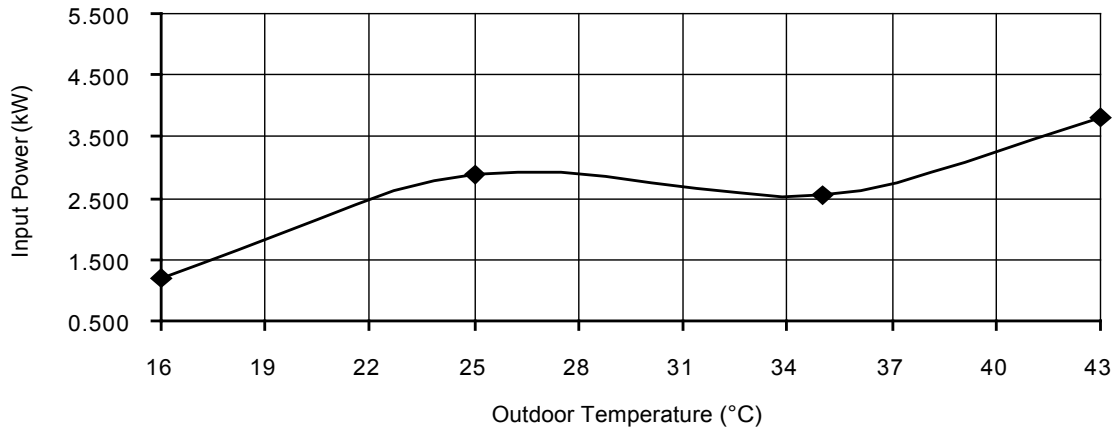
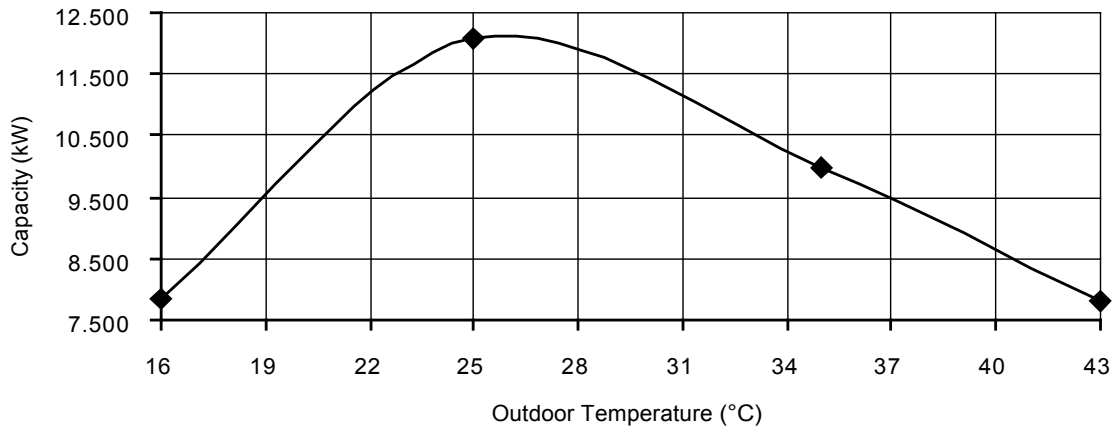



### Cooling Characteristics at Different Outdoor Air Temperature

Condition

Outdoor air temperature : 35°C (DBT), -°C (WBT)

Indoor water inlet temperature : 19°C

Indoor water outlet temperature : 14°C

Piping length : 7 m

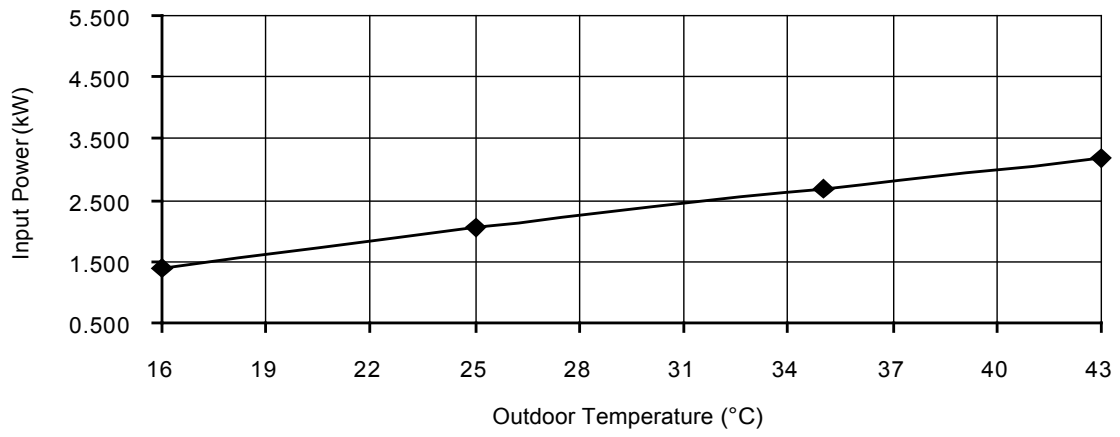
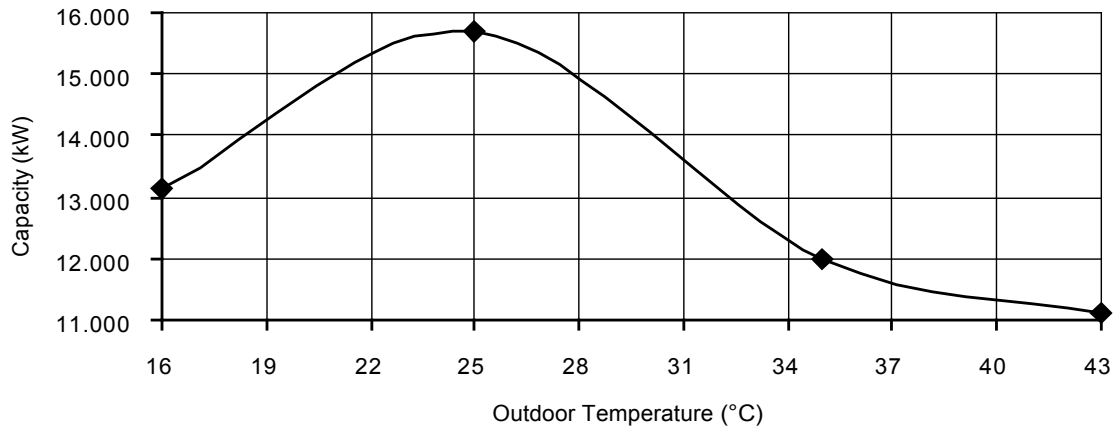

### Cooling Characteristics at Different Outdoor Air Temperature

Condition

Outdoor air temperature : 35°C (DBT), -°C (WBT)

Indoor water inlet temperature : 23°C

Indoor water outlet temperature : 18°C

Piping length : 7 m

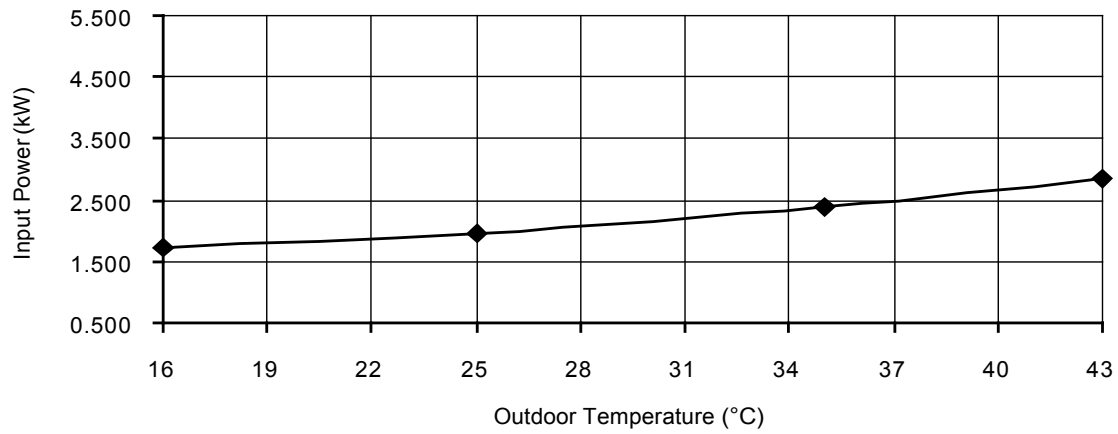
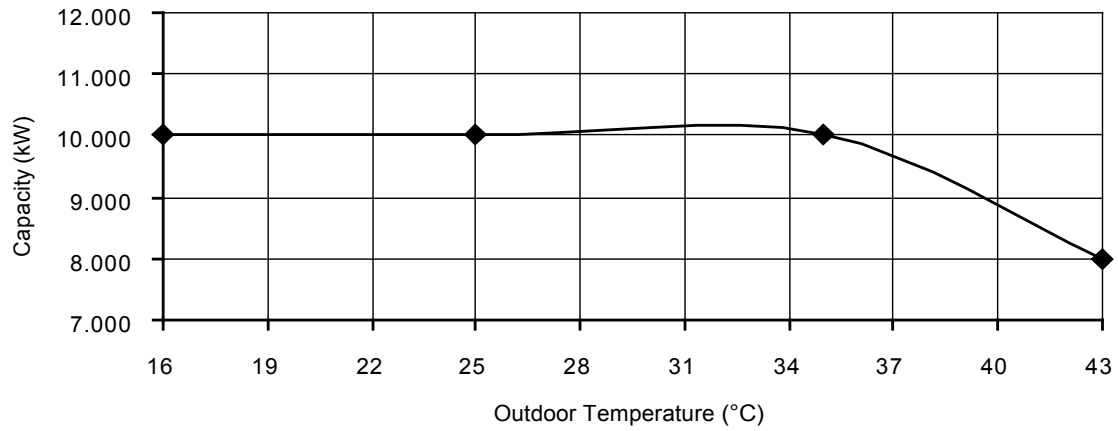

### Heating Characteristics at Different Piping Length

Condition

Outdoor air temperature : 7°C (DBT), 6°C (WBT)

Indoor water inlet temperature : 30°C

Indoor water outlet temperature : 35°C

Piping length : 7 m

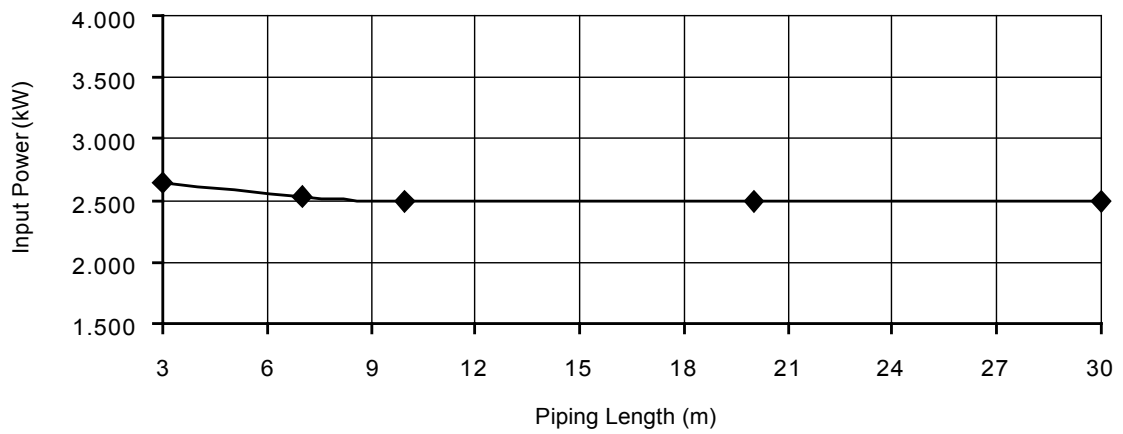
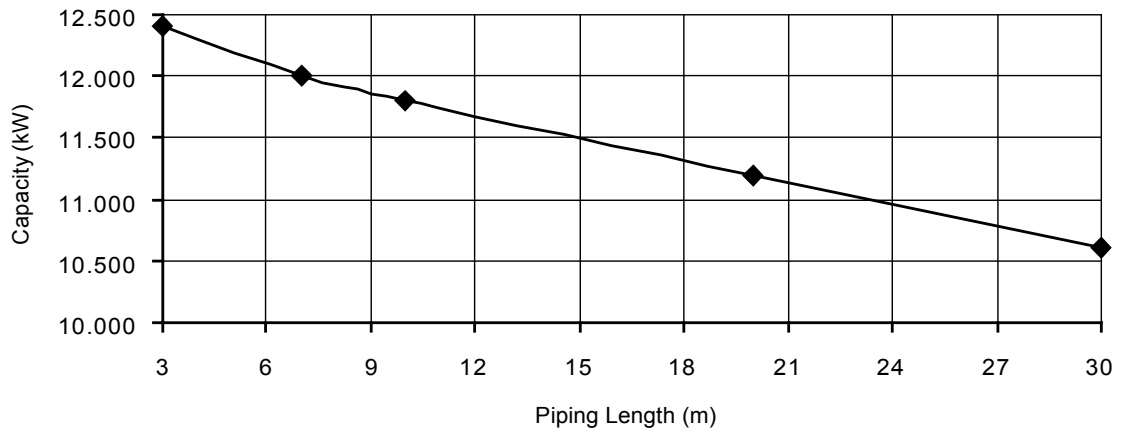

### Cooling Characteristics at Different Piping Length

Condition

Outdoor air temperature : 35°C (DBT), -°C (WBT)

Indoor water inlet temperature : 12°C

Indoor water outlet temperature : 7°C

Piping length : 7 m

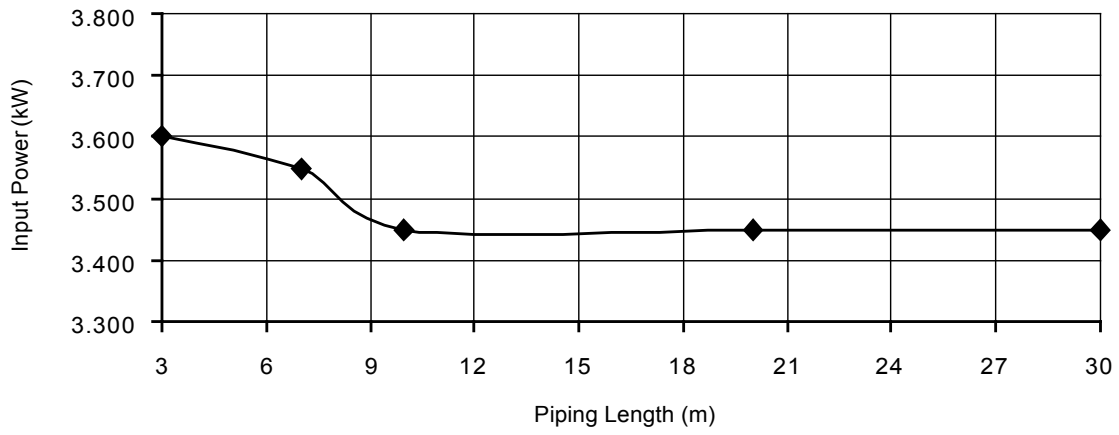
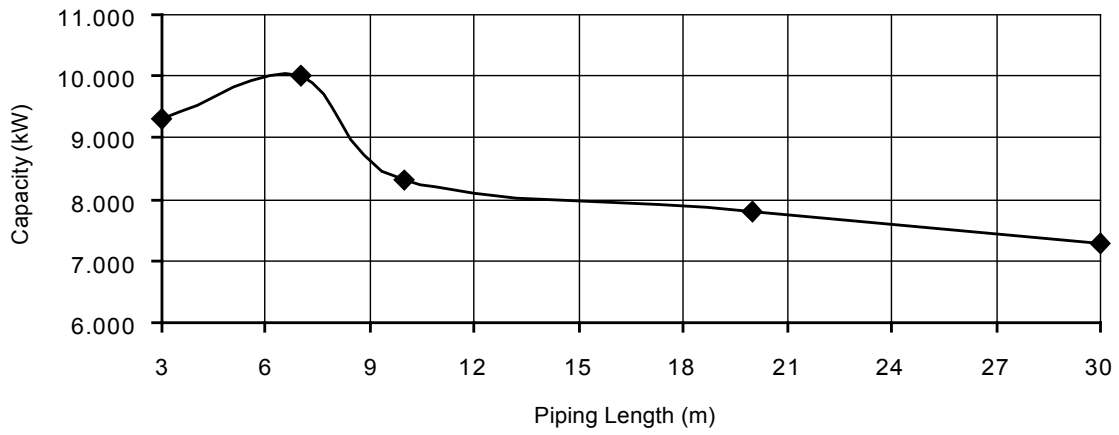

### 19.1.3 WH-SDC14F9E8 WH-UD14FE8

#### Heating Characteristics at Different Outdoor Air Temperature

Condition

Outdoor air temperature : 7°C (DBT), 6°C (WBT)

Indoor water inlet temperature : 30°C

Indoor water outlet temperature : 35°C

Piping length : 7 m

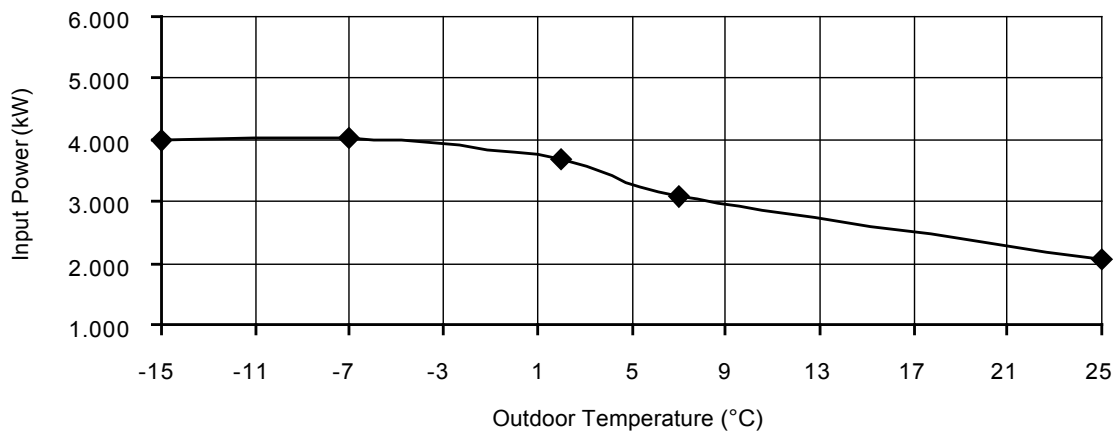
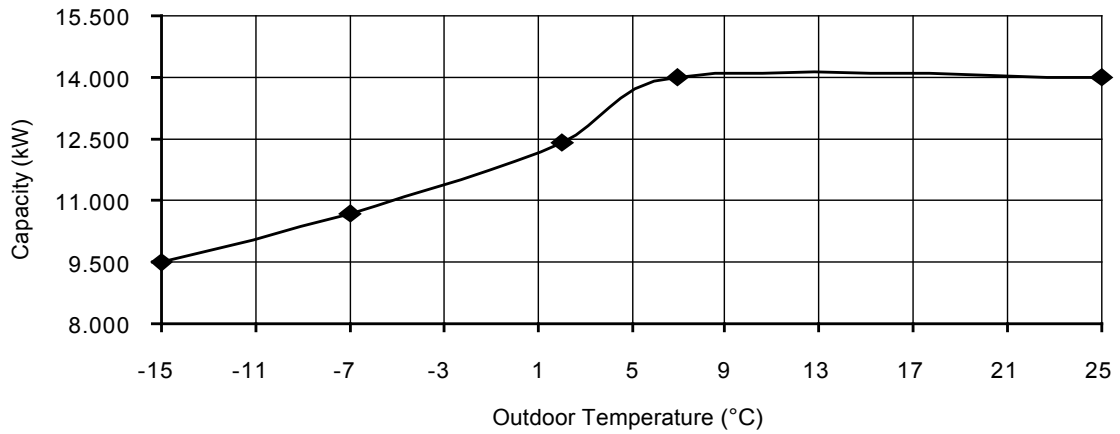

### Cooling Characteristics at Different Outdoor Air Temperature

Condition

Outdoor air temperature : 35°C (DBT), -°C (WBT)

Indoor water inlet temperature : 12°C

Indoor water outlet temperature : 7°C

Piping length : 7 m

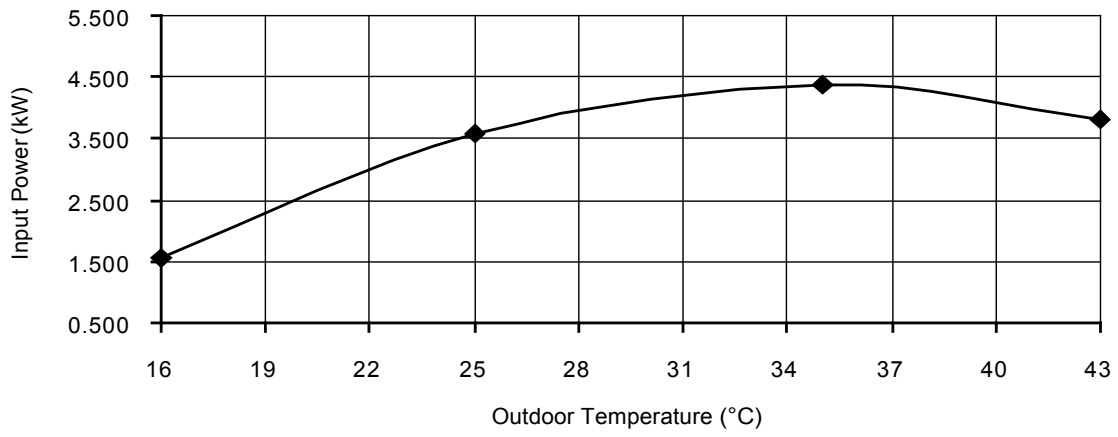
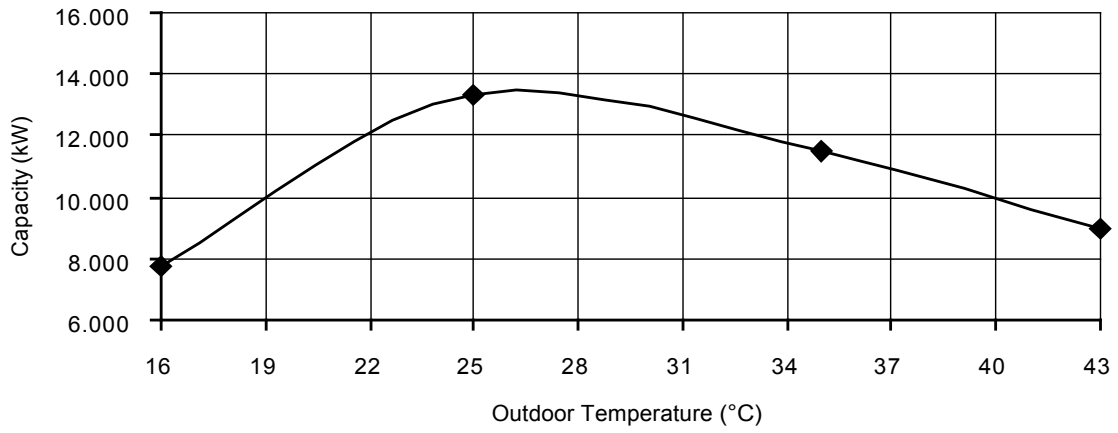

### Cooling Characteristics at Different Outdoor Air Temperature

Condition

Outdoor air temperature : 35°C (DBT), -°C (WBT)

Indoor water inlet temperature : 19°C

Indoor water outlet temperature : 14°C

Piping length : 7 m

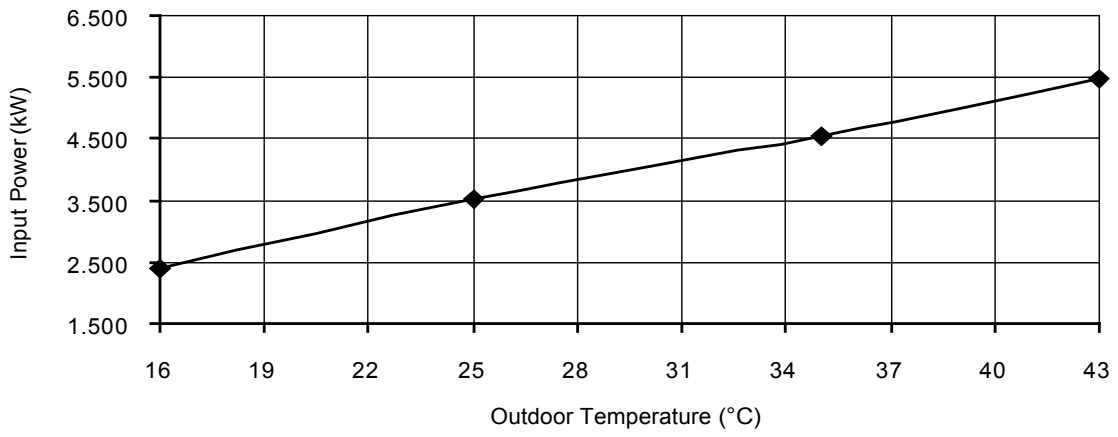
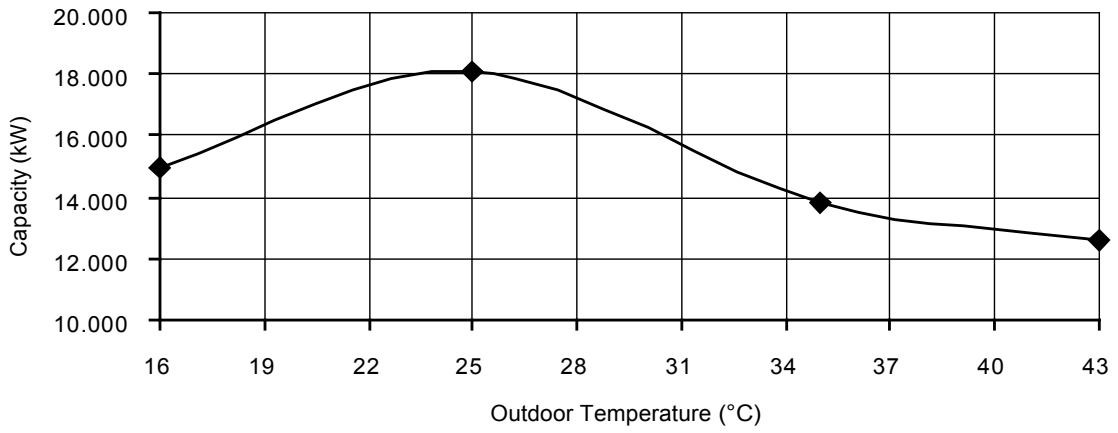

### Cooling Characteristics at Different Outdoor Air Temperature

Condition

Outdoor air temperature : 35°C (DBT), -°C (WBT)

Indoor water inlet temperature : 23°C

Indoor water outlet temperature : 18°C

Piping length : 7 m

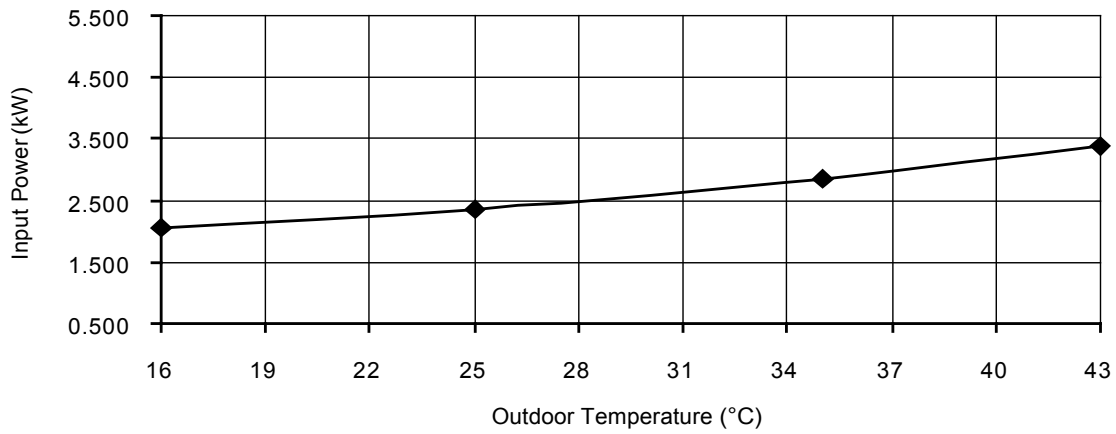
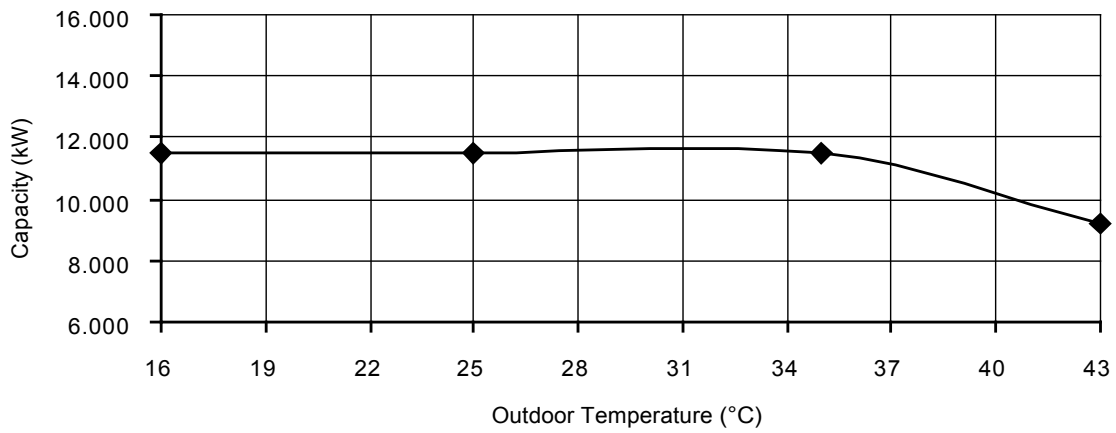



### Heating Characteristics at Different Piping Length

Condition

Outdoor air temperature : 7°C (DBT), 6°C (WBT)

Indoor water inlet temperature : 30°C

Indoor water outlet temperature : 35°C

Piping length : 7 m

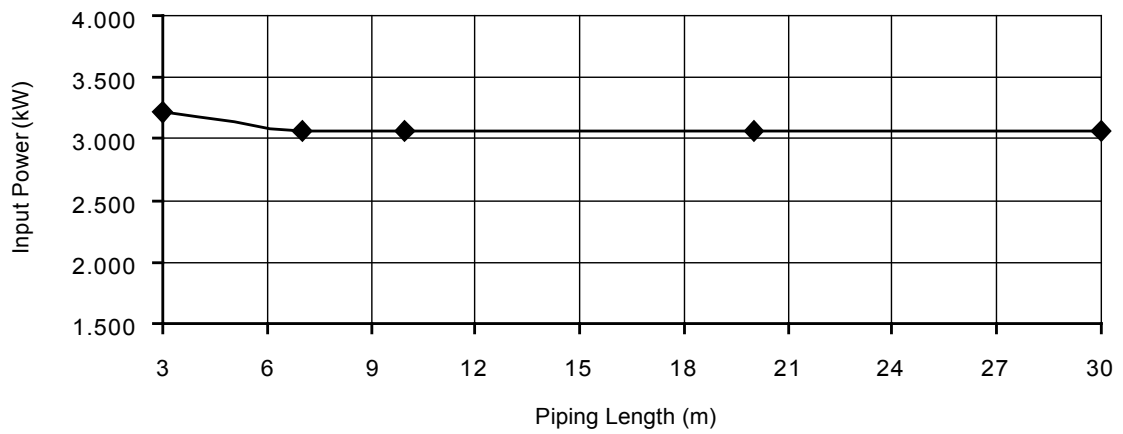
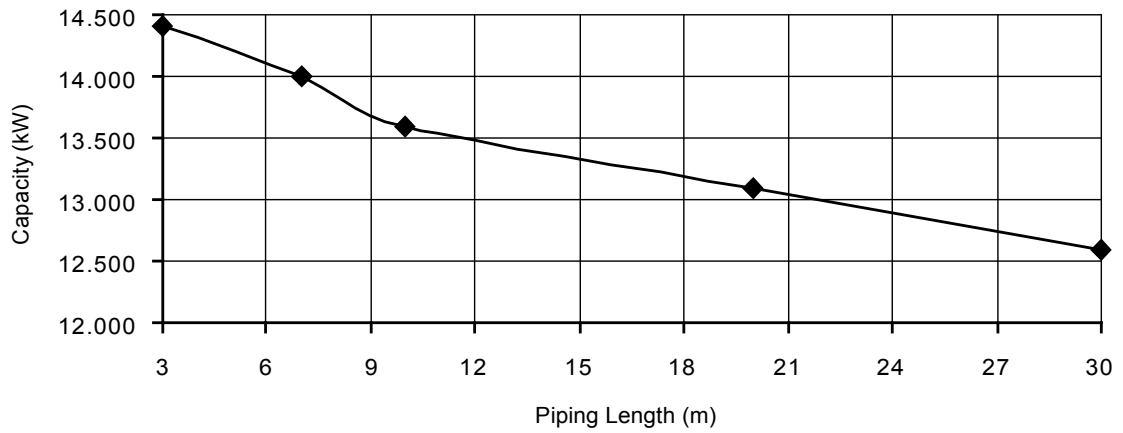

### Cooling Characteristics at Different Piping Length

Condition

Outdoor air temperature : 35°C (DBT), -°C (WBT)

Indoor water inlet temperature : 12°C

Indoor water outlet temperature : 7°C

Piping length : 7 m

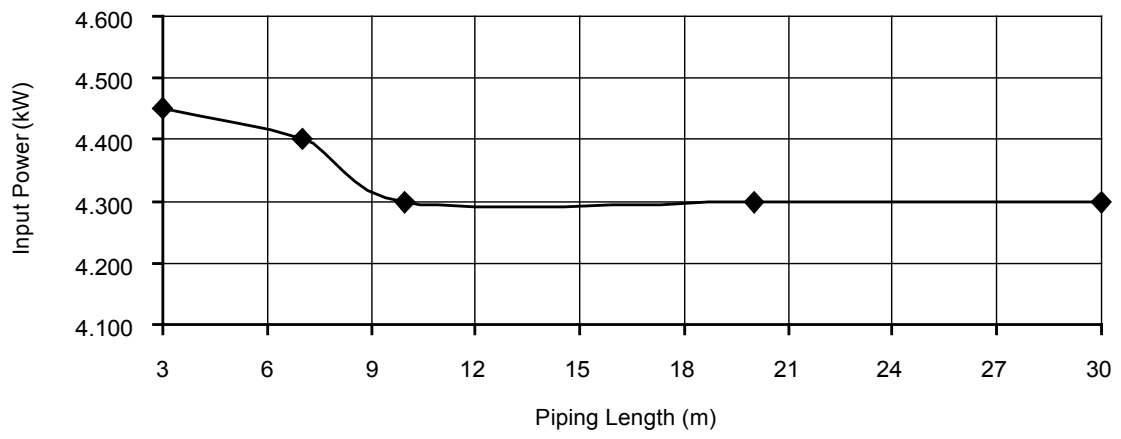
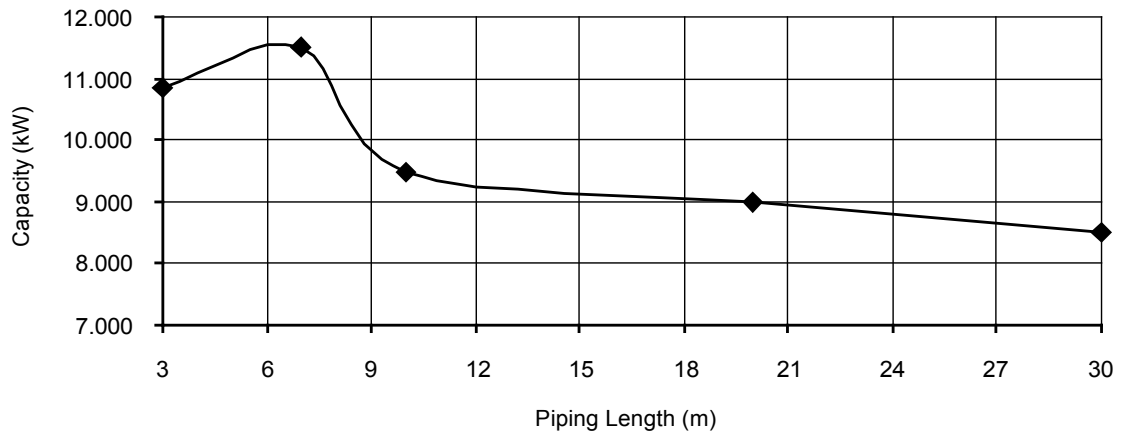

### 19.1.4 WH-SDC16F9E8 WH-UD16FE8

#### Heating Characteristics at Different Outdoor Air Temperature

Condition

Outdoor air temperature : 7°C (DBT), 6°C (WBT)

Indoor water inlet temperature : 30°C

Indoor water outlet temperature : 35°C

Piping length : 7 m

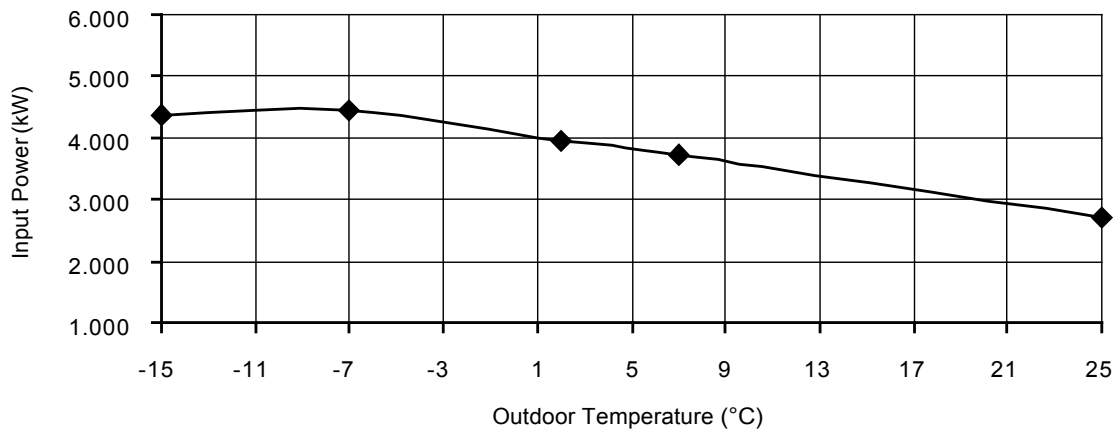
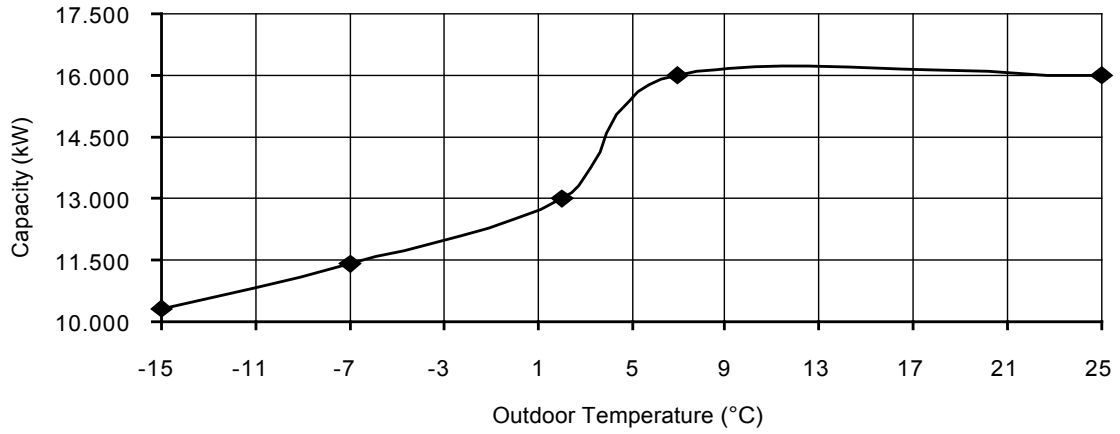

### Cooling Characteristics at Different Outdoor Air Temperature

Condition

Outdoor air temperature : 35°C (DBT), -°C (WBT)

Indoor water inlet temperature : 12°C

Indoor water outlet temperature : 7°C

Piping length : 7 m

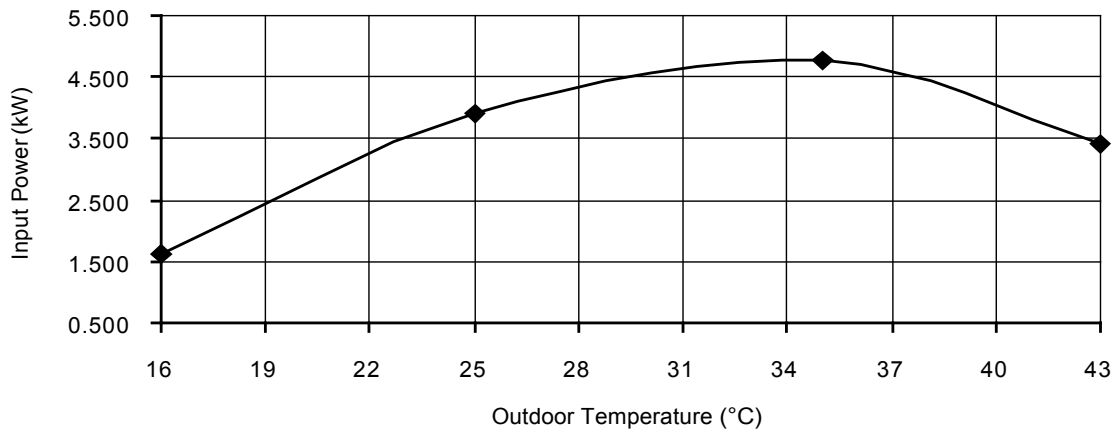
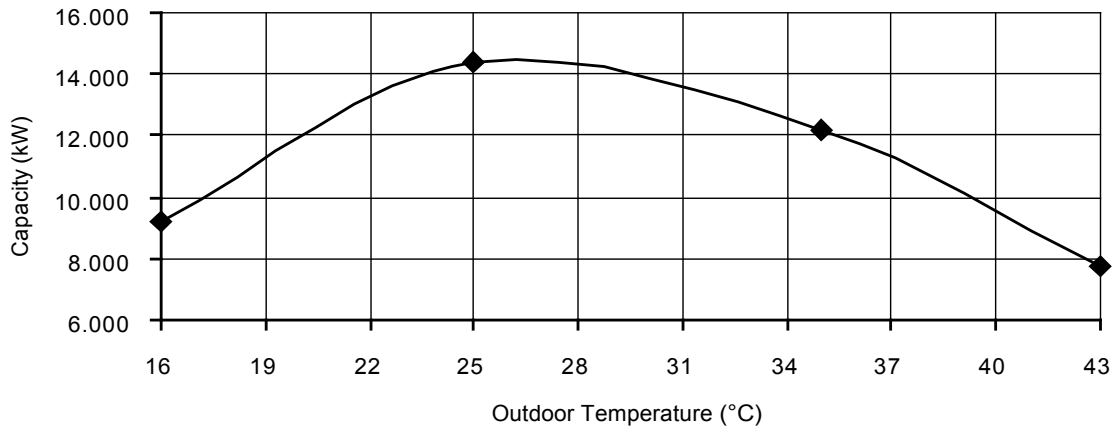

### Cooling Characteristics at Different Outdoor Air Temperature

Condition

Outdoor air temperature : 35°C (DBT), -°C (WBT)

Indoor water inlet temperature : 19°C

Indoor water outlet temperature : 14°C

Piping length : 7 m

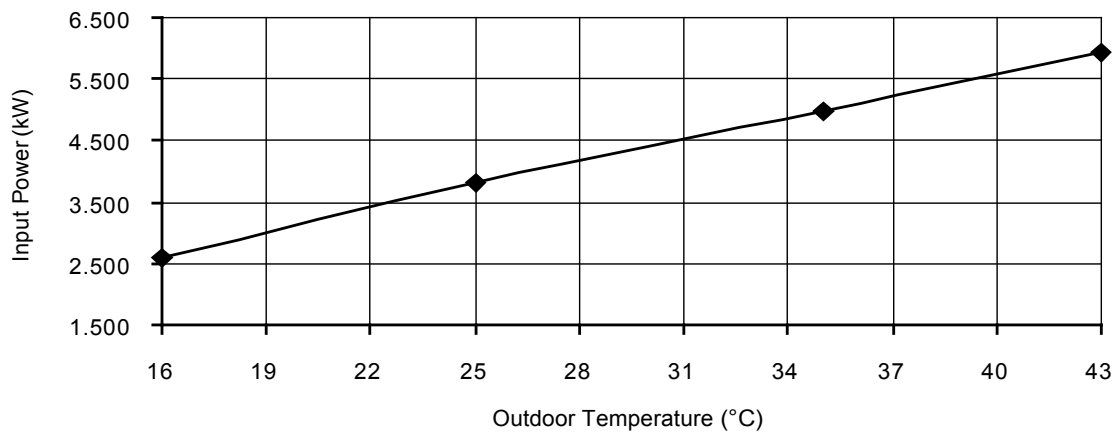
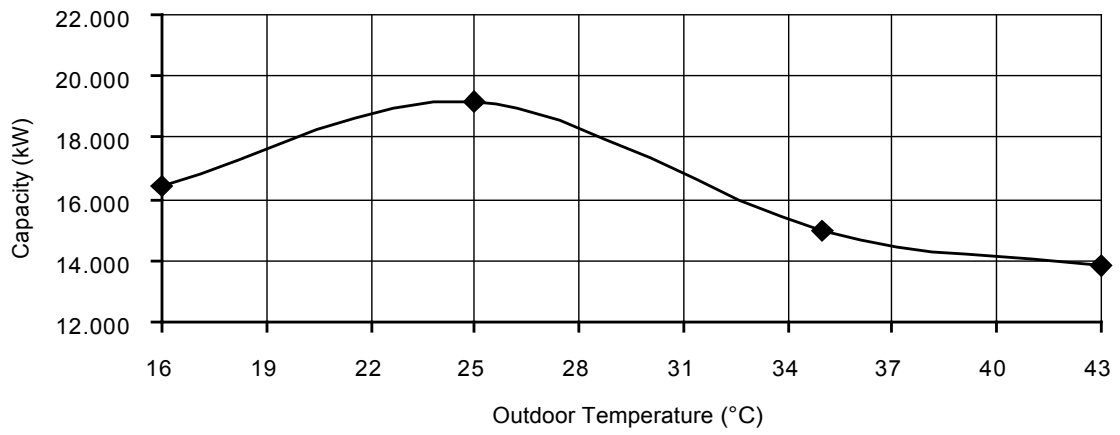

### Cooling Characteristics at Different Outdoor Air Temperature

Condition

Outdoor air temperature : 35°C (DBT), -°C (WBT)

Indoor water inlet temperature : 23°C

Indoor water outlet temperature : 18°C

Piping length : 7 m

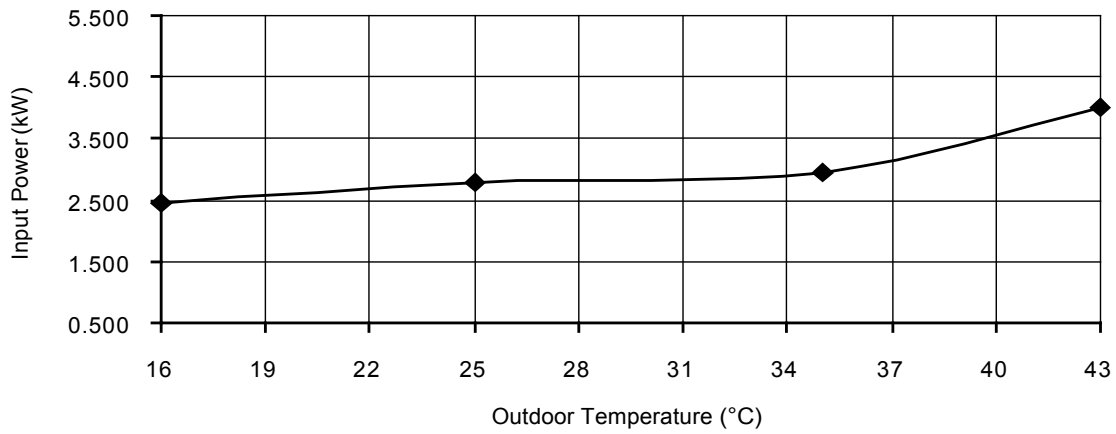
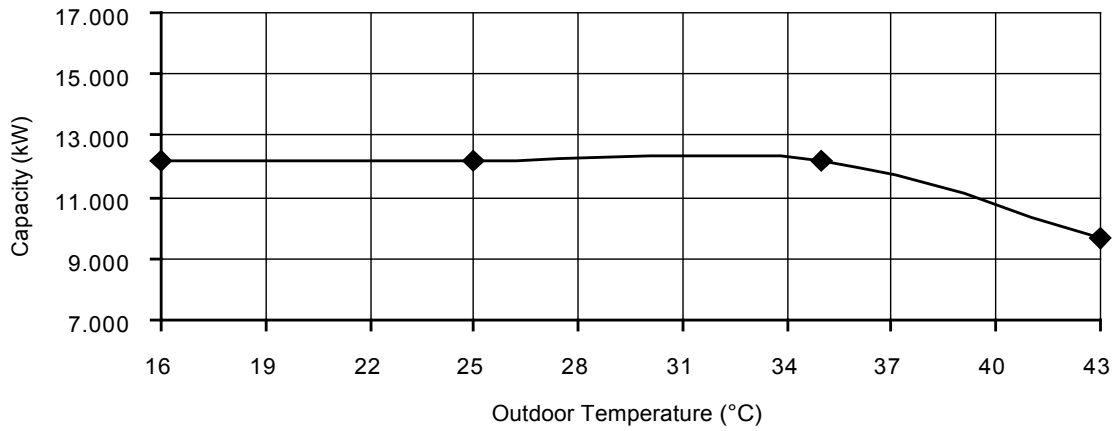

### Heating Characteristics at Different Piping Length

Condition

Outdoor air temperature : 7°C (DBT), 6°C (WBT)

Indoor water inlet temperature : 30°C

Indoor water outlet temperature : 35°C

Piping length : 7 m

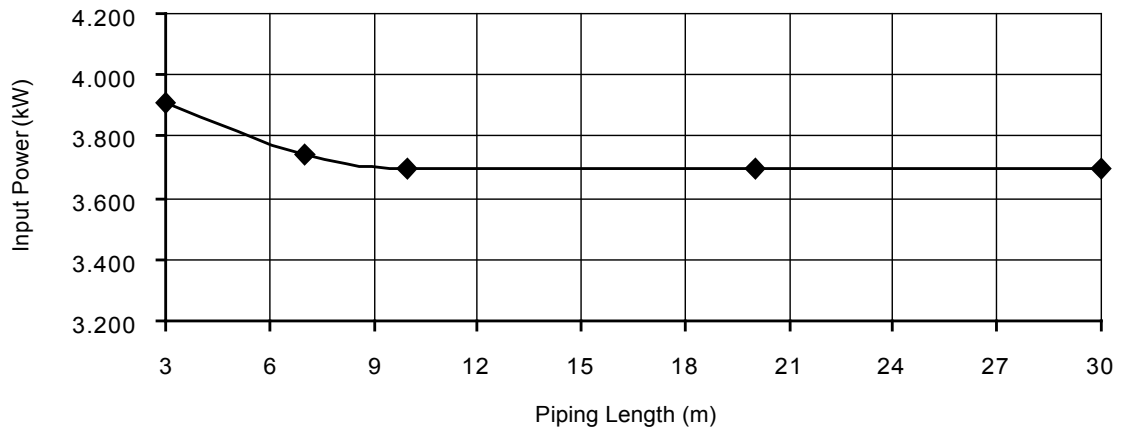
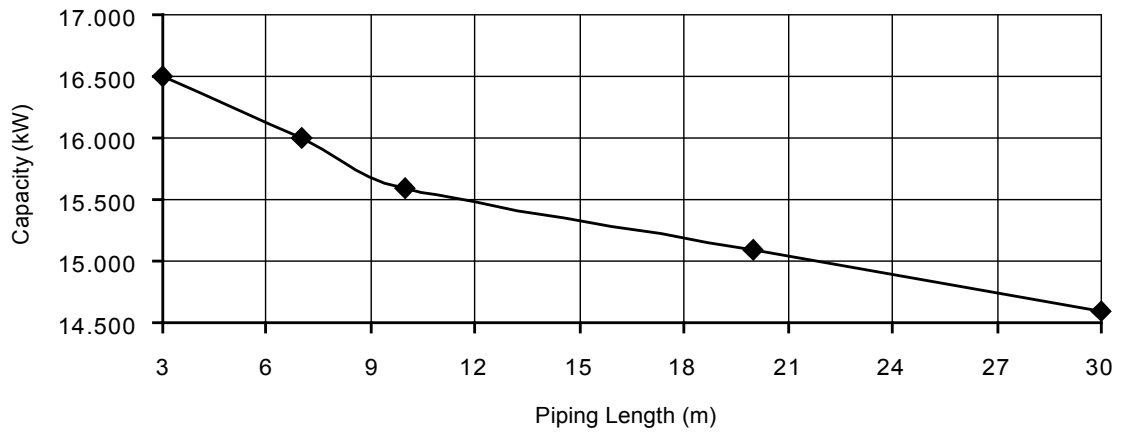

### Cooling Characteristics at Different Piping Length

Condition

Outdoor air temperature : 35°C (DBT), -°C (WBT)

Indoor water inlet temperature : 12°C

Indoor water outlet temperature : 7°C

Piping length : 7 m

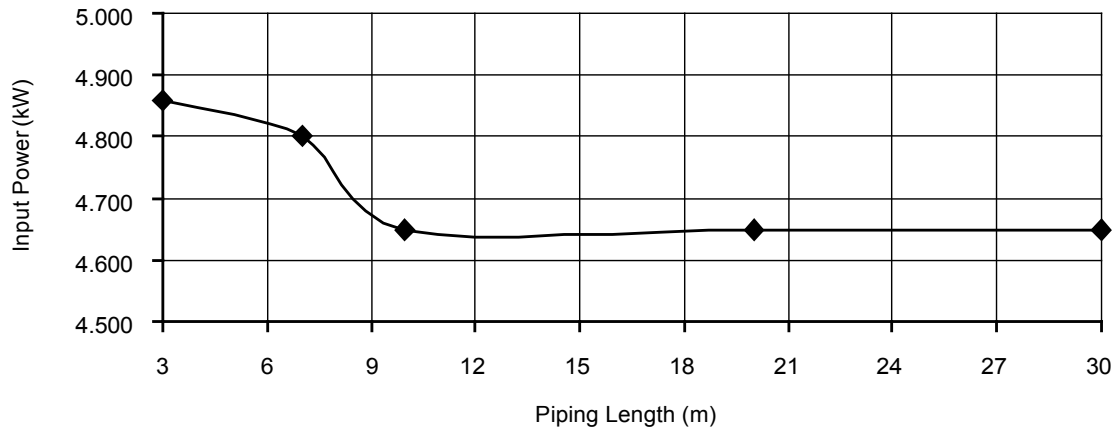
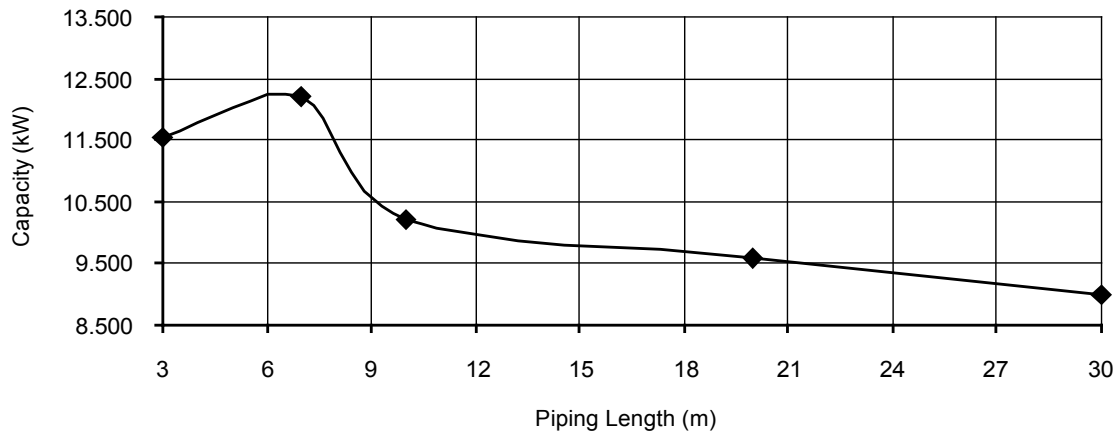



## 19.2 Heating Capacity Table

### 19.2.1 WH-SDC09F3E8 WH-UD09FE8

Water Out (°C)	30		35		40		45		50		55	
Outdoor Air (°C)	Capacity (W)	Input Power (W)	Capacity (W)	Input Power (W)	Capacity (W)	Input Power (W)	Capacity (W)	Input Power (W)	Capacity (W)	Input Power (W)	Capacity (W)	Input Power (W)
-15	8650	3060	8300	3210	7950	3410	7600	3610	7150	3710	6700	3810
-7	9350	2910	9000	3160	8850	3540	8700	3920	8300	3890	7900	3860
2	9310	2350	9000	2510	9000	2780	9000	3050	8900	3490	8800	3940
7	9000	1540	9000	1860	9000	2160	9000	2460	9000	2760	9000	3060
25	9000	1050	9000	1240	8730	1440	8460	1640	8280	1820	8100	2000

### 19.2.2 WH-SDC12F9E8 WH-UD12FE8

Water Out (°C)	30		35		40		45		50		55	
Outdoor Air (°C)	Capacity (W)	Input Power (W)	Capacity (W)	Input Power (W)	Capacity (W)	Input Power (W)	Capacity (W)	Input Power (W)	Capacity (W)	Input Power (W)	Capacity (W)	Input Power (W)
-15	9300	3460	8900	3620	8500	3790	8100	3950	7500	4050	7000	4160
-7	10400	3370	10000	3660	9600	3950	9200	4240	8700	4260	8200	4270
2	11800	3100	11400	3310	11000	3530	10600	3740	9800	3940	9100	4140
7	12000	2100	12000	2530	12000	2960	12000	3390	12000	3780	12000	4160
25	12000	1380	12000	1660	11800	1940	11700	2230	11500	2490	11400	2740

### 19.2.3 WH-SDC14F9E8 WH-UD14FE8

Water Out (°C)	30		35		40		45		50		55	
Outdoor Air (°C)	Capacity (W)	Input Power (W)	Capacity (W)	Input Power (W)	Capacity (W)	Input Power (W)	Capacity (W)	Input Power (W)	Capacity (W)	Input Power (W)	Capacity (W)	Input Power (W)
-15	9900	3870	9500	4010	9000	4150	8600	4290	7900	4410	7300	4520
-7	11100	3690	10700	4040	10200	4390	9800	4740	9100	4720	8500	4700
2	12900	3470	12400	3690	11900	3910	11400	4130	10400	4250	9500	4360
7	14000	2560	14000	3070	14000	3590	14000	4100	13600	4570	13300	5040
25	14000	1710	14000	2060	14000	2410	14000	2760	14000	3010	14000	3400

### 19.2.4 WH-SDC16F9E8 WH-UD16FE8

Water Out (°C)	30		35		40		45		50		55	
Outdoor Air (°C)	Capacity (W)	Input Power (W)	Capacity (W)	Input Power (W)	Capacity (W)	Input Power (W)	Capacity (W)	Input Power (W)	Capacity (W)	Input Power (W)	Capacity (W)	Input Power (W)
-15	10600	4090	10300	4380	10000	4670	9700	4960	8800	4940	7900	4910
-7	11900	4030	11400	4430	10800	4830	10300	5220	9600	5090	9000	4950
2	13500	3740	13000	3960	12400	4180	11900	4400	10800	4460	9800	4510
7	16000	3210	16000	3740	16000	4270	16000	4800	15200	5110	14500	5410
25	16000	2310	16000	2690	16000	3070	16000	3450	16000	3670	15900	3890

## 19.3 Cooling Capacity Table

### 19.3.1 WH-SDC09F3E8 WH-UD09FE8

Water In (°C)	12		19		23	
Water Out (°C)	7		14		18	
Outdoor Air (°C)	Capacity (W)	Input Power (W)	Capacity (W)	Input Power (W)	Capacity (W)	Input Power (W)
16	7500	1150	9100	1200	7000	1130
25	8350	1770	10900	1780	7000	1240
35	7000	2230	8300	2320	7000	1520
43	5520	2540	7690	2770	5600	1800

### 19.3.2 WH-SDC12F9E8 WH-UD12FE8

Water In (°C)	12		19		23	
Water Out (°C)	7		14		18	
Outdoor Air (°C)	Capacity (W)	Input Power (W)	Capacity (W)	Input Power (W)	Capacity (W)	Input Power (W)
16	7860	1180	13150	1400	10000	1730
25	12080	2900	15700	2050	10000	1970
35	10000	2560	12000	2670	10000	2400
43	7800	3800	11100	3190	8000	2850

### 19.3.3 WH-SDC14F9E8 WH-UD14FE8

Water In (°C)	12		19		23	
Water Out (°C)	7		14		18	
Outdoor Air (°C)	Capacity (W)	Input Power (W)	Capacity (W)	Input Power (W)	Capacity (W)	Input Power (W)
16	7750	1570	15000	2400	11500	2050
25	13300	3570	18100	3520	11500	2340
35	11500	4360	13800	4560	11500	2850
43	8980	3800	12600	5470	9200	3380

### 19.3.4 WH-SDC16F9E8 WH-UD16FE8

Water In (°C)	12		19		23	
Water Out (°C)	7		14		18	
Outdoor Air (°C)	Capacity (W)	Input Power (W)	Capacity (W)	Input Power (W)	Capacity (W)	Input Power (W)
16	9200	1620	16400	2580	12200	2450
25	14400	3920	19200	3830	12200	2790
35	12200	4760	15000	4980	12200	2960
43	7750	3400	13800	5950	9700	4000

## 20. Exploded View and Replacement Parts List

### 20.1 Indoor Unit

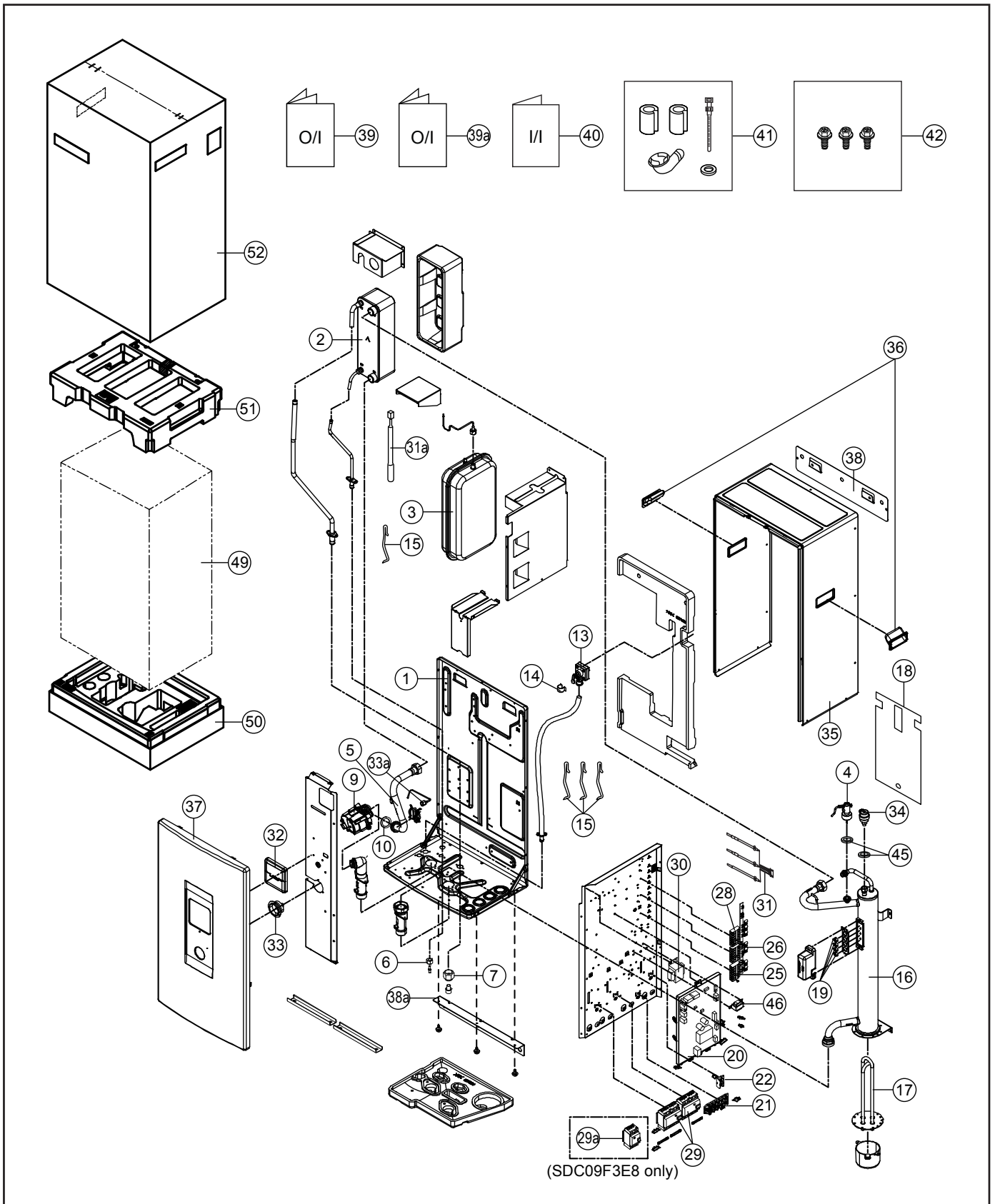

**Note:**

- The above exploded view is for the purpose of parts disassembly and replacement.
- The non-numbered parts are not kept as standard service parts.

<Model: WH-SDC09F3E8 WH-SDC12F9E8>

SAFETY	REF. NO.	DESCRIPTION & NAME	QTY.	WH-SDC09F3E8	WH-SDC12F9E8	REMARK
	1	BASE PAN	1	CWD521279	←	
	2	HOT WATER COIL - COMPLETE	1	CWB90C1109	←	
	3	RECEIVER	1	CWB141039	←	
	4	FLOW SWITCH VALVE	1	CWB621128	←	O
	5	TUBE CONNECTOR - COMPLETE	1	CWT029525	←	
	6	FLARE NUT (5/8) - REFRIGERANT	1	CWT251061	←	
	7	FLARE NUT (3/8) - LIQUID	1	CWT251064	←	
	9	WATER PUMP	1	CWB532116	←	O
	10	PACKING (O-RING) I.D 32mm	1	CWB811082	←	
	13	PRESSURE RELIEF VALVE	1	CWB621092	←	O
	14	RETAINING RING D:22mm	1	CWH581007	←	
	15	CLIP SENSOR	4	CWH32138	←	
	16	BOTTLE COMPLETE	1	CWH90C0044	CWH90C0045	
	17	HEATER ASS'Y	1	CWA34K1042	CWA34K1030	
	18	SOUND PROOF MATERIAL	1	CWG302835	CWG302853	O
	19	THERMOSTAT	4	CWA151074	←	O
⚠	20	ELECTRONIC CONTROLLER - MAIN	1	CWA73C8545	CWA73C8544	O
⚠	21	TERMINAL BOARD ASS'Y (TO OUTDOOR)	1	CWA28K1240	←	O
⚠	22	TERMINAL BOARD ASS'Y (HEATER)	1	CWA28K1236	←	O
⚠	25	TERMINAL BOARD ASS'Y (TO 2,3 WAY VALVE)	1	CWA28K1229	←	O
⚠	26	TERMINAL BOARD ASS'Y (TO BOOSTER HEATER & ROOM THERMOSTAT)	1	CWA28K1230	←	O
⚠	28	TERMINAL BOARD ASS'Y (TO TANK)	1	CWA28K1231	←	O
	29	CIRCUIT BREAKER	1	CWA181008	←	O
	29a	CIRCUIT BREAKER	1	K5KYYAY00003	-	O
	30	TRANSFORMER - COMPLETE	1	CWA40C1096	←	O
	31	SENSOR - COMPLETE (CN-TH1)	1	CWA50C2762	←	O
	31a	SENSOR - COMPLETE (CN-TH3)	1	CWA50C3164	←	O
⚠	32	REMOTE CONTROL COMPLETE	1	CWA75C4464	←	O
	33	PRESSURE GAUGE	1	CWB070001	←	O
	33a	FLARE NUT (1/4)	1	CWT251063	←	
	34	AIR PURGE VALVE	1	CWB621094	←	O
	35	CABINET	1	CWE001050A	←	
	36	HANDLE	2	CWE161008	←	
	37	CABINET FRONT PLATE	1	CWE061265A	←	
	38	INSTALLING HOLDER	1	CWH361103A	←	
	38a	INSTALLING HOLDER	1	CWH361119A	←	
	39	OPERATING INSTRUCTION	1	CWF569382	←	
	39a	OPERATING INSTRUCTION	1	CWF569383	←	
	40	INSTALLATION INSTRUCTION	1	CWF616149	←	
	41	ACCESSORY - COMPLETE (L-TUBE)	1	CWH82C1763	←	
	42	ACCESSORY - COMPLETE	1	CWH82C1754	←	
	45	PACKING (O-RING) I.D 2.8mm	2	CWB811190	←	
⚠	46	REACTOR	1	G0C103Z00003	←	O
	49	BAG	1	CWG861447	←	
	50	BASE BOARD - COMPLETE	1	CWG62C1124	←	
	51	SHOCK ABSORBER	1	CWG713189	←	
	52	C.C.CASE	1	CWG568364	←	

**Note:**

- All parts are supplied from PAPAMY, Malaysia (Vendor Code: 00029488).
- "O" marked parts are recommended to be kept in stock.

<Model: WH-SDC14F9E8 WH-SDC16F9E8>

SAFETY	REF. NO.	DESCRIPTION & NAME	QTY.	WH-SDC14F9E8	WH-SDC16F9E8	REMARK
	1	BASE PAN	1	CWD521279	←	
	2	HOT WATER COIL - COMPLETE	1	CWB90C1110	←	
	3	RECEIVER	1	CWB141039	←	
	4	FLOW SWITCH VALVE	1	CWB621128	←	O
	5	TUBE CONNECTOR - COMPLETE	1	CWT029525	←	
	6	FLARE NUT (5/8) - REFRIGERANT	1	CWT251061	←	
	7	FLARE NUT (7/8) - LIQUID	1	CWT251064	←	
	9	WATER PUMP	1	CWB532116	←	O
	10	PACKING (O-RING) I.D 32mm	1	CWB811082	←	
	13	PRESSURE RELIEF VALVE	1	CWB621092	←	O
	14	RETAINING RING D:22mm	1	CWH581007	←	
	15	CLIP SENSOR	4	CWH32138	←	
	16	BOTTLE COMPLETE	1	CWH90C0045	←	
	17	HEATER ASS'Y	1	CWA34K1030	←	
	18	SOUND PROOF MATERIAL	1	CWG302853	←	O
	19	THERMOSTAT	4	CWA151074	←	O
⚠	20	ELECTRONIC CONTROLLER - MAIN	1	CWA73C8543	CWA73C8542	O
⚠	21	TERMINAL BOARD ASS'Y (TO OUTDOOR)	1	CWA28K1240	←	O
⚠	22	TERMINAL BOARD ASS'Y (TO HEATER)	1	CWA28K1236	←	O
⚠	25	TERMINAL BOARD ASS'Y (TO 2,3 WAY VALVE)	1	CWA28K1229	←	O
⚠	26	TERMINAL BOARD ASS'Y (TO BOOSTER HEATER & ROOM THERMOSTAT)	1	CWA28K1230	←	O
⚠	28	TERMINAL BOARD ASS'Y (TO TANK)	1	CWA28K1231	←	O
	29	CIRCUIT BREAKER	2	CWA181008	←	O
	30	TRANSFORMER - COMPLETE	1	CWA40C1096	←	O
	31	SENSOR - COMPLETE (CN-TH1)	1	CWA50C2762	←	O
	31a	SENSOR - COMPLETE (CN-TH3)	1	CWA50C3164	←	O
⚠	32	REMOTE CONTROL COMPLETE	1	CWA75C4464	←	O
	33	PRESSURE GAUGE	1	CWB070001	←	O
	33a	FLARE NUT (1/4)	1	CWT251063	←	
	34	AIR PURGE VALVE	1	CWB621094	←	O
	35	CABINET	1	CWE001050A	←	
	36	HANDLE	2	CWE161008	←	
	37	CABINET FRONT PLATE	1	CWE061265A	←	
	38	INSTALLING HOLDER	1	CWH361103A	←	
	38a	INSTALLING HOLDER	1	CWH361119A	←	
	39	OPERATING INSTRUCTION	1	CWF569382	←	
	39a	OPERATING INSTRUCTION	1	CWF569383	←	
	40	INSTALLATION INSTRUCTION	1	CWF616506	←	
	41	ACCESSORY - COMPLETE (L-TUBE)	1	CWH82C1763	←	
	42	ACCESSORY - COMPLETE	1	CWH82C1754	←	
	45	PACKING (O-RING) I.D 2.8mm	2	CWB811190	←	
⚠	46	REACTOR	1	G0C103Z00003	←	O
	49	BAG	1	CWG861447	←	
	50	BASE BOARD - COMPLETE	1	CWG62C1124	←	
	51	SHOCK ABSORBER	1	CWG713189	←	
	52	C.C.CASE	1	CWG568364	←	

**Note:**

- All parts are supplied from PAPAMY, Malaysia (Vendor Code: 00029488).
- "O" marked parts are recommended to be kept in stock.

## 20.2 Outdoor Unit

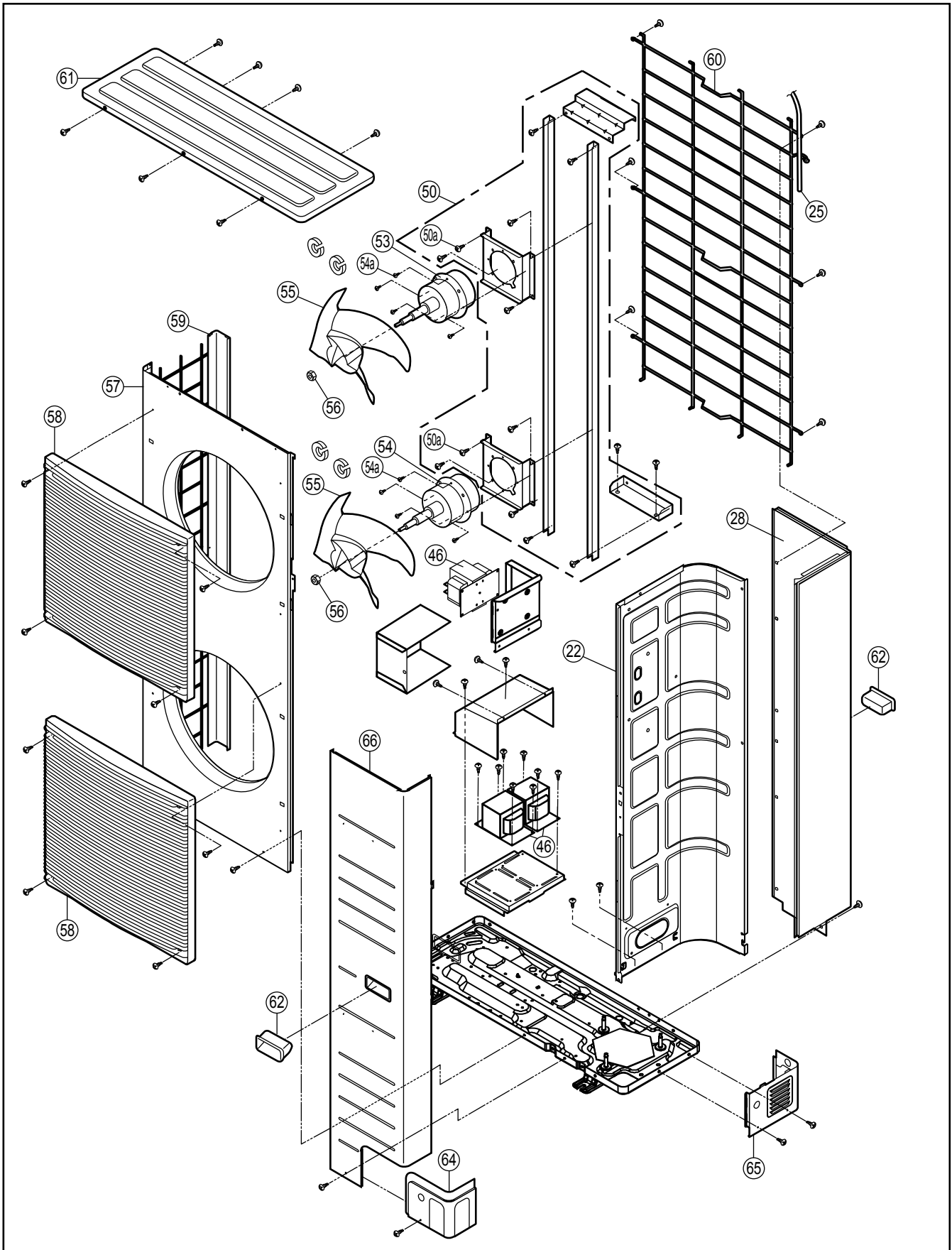

**Note:**

- The above exploded view is for the purpose of parts disassembly and replacement.
- The non-numbered parts are not kept as standard service parts.

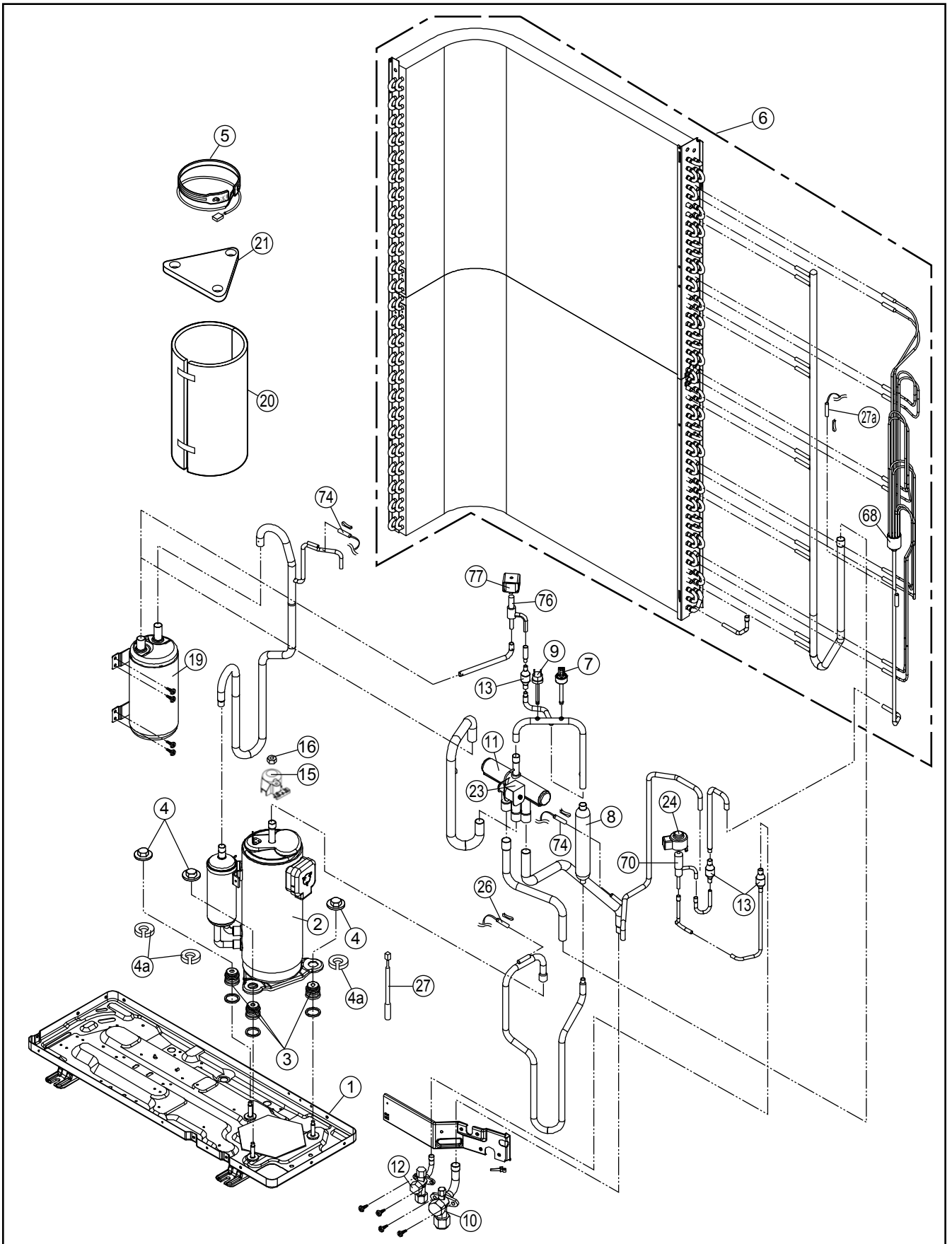

**Note:**

- The above exploded view is for the purpose of parts disassembly and replacement.
- The non-numbered parts are not kept as standard service parts.

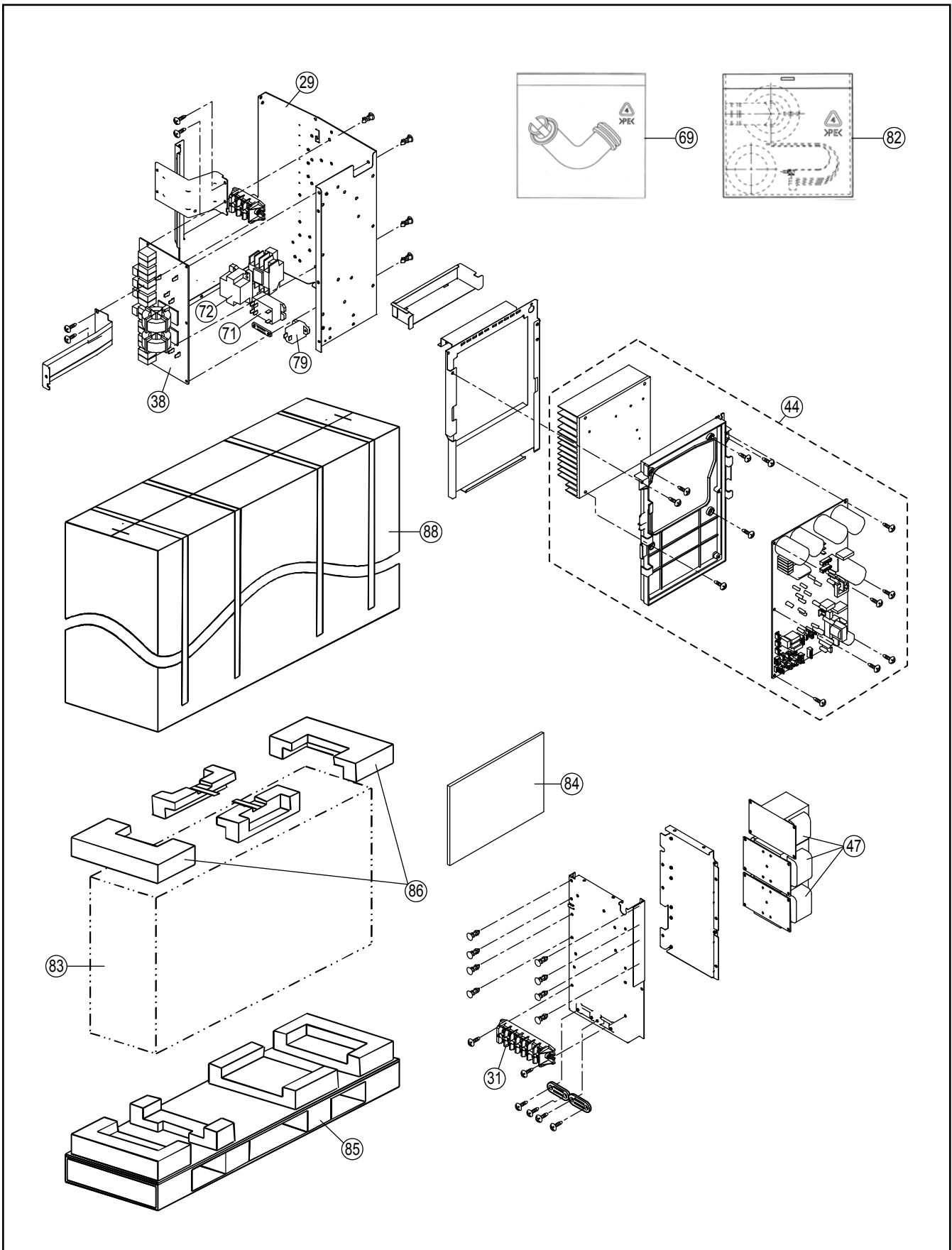

**Note:**

- The above exploded view is for the purpose of parts disassembly and replacement.
- The non-numbered parts are not kept as standard service parts.



<Model: WH-UD09FE8 WH-UD12FE8>

SAFETY	REF. NO.	DESCRIPTION & NAME	QTY.	WH-UD09FE8	WH-UD12FE8	REMARK
	1	BASE PAN ASS'Y	1	CWD52K1275	←	
	2	COMPRESSOR	1	5JD420XBA22	←	O
	3	BUSHING - COMPRESSOR MOUNT	3	CWH50055	←	
	4	NUT - COMPRESSOR MOUNT	3	CWH561049	←	
	4a	GASKET FOR TERMINAL COVER	3	CWB811017	←	
	5	CRANKCASE HEATER	1	CWA341053	←	
	6	CONDENSER COMPLETE	1	CWB32C3986	←	
	7	HIGH PRESSURE SENSOR	1	CWA501463	←	O
	8	DISCHARGE MUFFLER	1	CWB121014	←	
	9	PRESSURE SWITCH	1	CWA101007	←	
	10	3-WAYS VALVE (GAS)	1	CWB011251	←	O
	11	4-WAYS VALVE	1	CWB001046	←	O
	12	3-WAYS VALVE	1	CWB011292	←	O
	13	STRAINER	3	CWB111032	←	
	15	TERMINAL COVER	1	CWH171039A	←	
	16	NUT - TERMINAL COVER	1	CWH7080300J	←	
	19	ACCUMULATOR	1	CWB131026A	←	
	20	SOUND PROOF MATERIAL	1	CWG302881	←	
	21	SOUND PROOF MATERIAL	1	CWG302266	←	
	22	SOUND PROOF BOARD	1	CWH15K1031	←	
	23	V-COIL COMPLETE (4-WAY VALVE)	1	CWA43C2169J	←	O
	24	V-COIL COMPLETE (MAIN)	1	CWA43C2602	←	O
	25	SENSOR - COMP. (OUTLET TEMP - TH1)	1	CWA50C2730	←	O
	26	SENSOR - COMP. (DISCHARGE TEMP - CN-DIS)	1	CWA50C2576	←	O
	27	SENSOR - COMPLETE - COM TANK (CN-TANK)	1	CWA50C2629	←	O
	27a	SENSOR - COMP. DEFROST TEMP (TH2)	1	CWA50C2577	←	O
	28	CABINET REAR PLATE - COMPLETE	1	CWE02C1059	←	
	29	CONTROL BOARD CASING	1	CWH10K1049	←	
	31	TERMINAL BOARD ASS'Y	1	CWA28K1214	←	O
	38	ELECTRONIC CONTROLLER - NF	1	CWA747838	←	O
	44	ELECTRONIC CONTROLLER - MAIN	1	CWA73C8538R	CWA73C8539R	O
	46	REACTOR (P1)	3	G0C293J00001	←	O
	47	REACTOR (P2)	3	G0C153J00009	←	O
	50	FAN MOTOR BRACKET	1	CWD54K1084	←	
	50a	SCREW - FAN MOTOR BRACKET	8	CWH551040J	←	
	53	FAN MOTOR (UPPER)	1	EHDS83CAC	←	O
	54	FAN MOTOR (BOTTOM)	1	EHDS83DAC	←	O
	54a	SCREW - FAN MOTOR MOUNT	8	CWH551323	←	
	55	PROPELLER FAN ASSY	2	CWH00K1006	←	
	56	NUT	2	CWH561092	←	
	57	CABINET FRONT PLATE	1	CWE061098A	←	
	58	DISCHARGE GRILLE	2	CWE201073	←	
	59	CABINET SIDE PLATE ASSY	1	CWE04K1023A	←	
	60	WIRE NET	1	CWD041103A	←	
	61	CABINET TOP PLATE CO.	1	CWE03C1096	←	
	62	HANDLE	2	CWE161008	←	
	64	PIPE COVER (FRONT)	1	CWD601074A	←	
	65	PIPE COVER (BACK)	1	CWD601075A	←	
	66	CABINET FRONT PLATE CO.	1	CWE06C1091	←	
	68	TUBE ASSY (CAP.TUBE)	1	CWT07K1606	←	
	69	ACCESSORY CO. (DRAIN ELBOW)	1	CWG87C900	←	
	70	EXPANSION VALVE	1	CWB051049	←	
	71	ELECTRO MAGNETIC SWITCH	1	K6C2AGA00002	←	O

SAFETY	REF. NO.	DESCRIPTION & NAME	QTY.	WH-UD09FE8	WH-UD12FE8	REMARK
	72	ELECTRO MAGNETIC SWITCH	1	K6C4E8A00001	←	O
	74	SENSOR - COMP. (CN-TH3)	1	CWA50C3204	←	O
	76	2-WAYS VALVE	1	CWB021637	←	O
	77	V-COIL COMPLETE (2-WAY VALVE)	1	CWA43C2607	←	O
	79	PTC THERMISTORS	1	D4DDG1010001	←	O
	82	ACCESSORY - COMPLETE	1	CWH82C2031	←	
	83	BAG	1	CWG861204	←	
	84	SHOCK ABSORBER	1	CWG712922	←	
	85	BASE BOARD - COMPLETE	1	CWG62C1086	←	
	86	SHOCK ABSORBER	2	CWG712852	←	
	88	C.C.CASE	1	CWG568054	←	

**Note:**

- All parts are supplied from PAPAMY, Malaysia (Vendor Code: 00029488).
- "O" marked parts are recommended to be kept in stock.

<Model: WH-UD14FE8 WH-UD16FE8>

SAFETY	REF. NO.	DESCRIPTION & NAME	QTY.	WH-UD14FE8	WH-UD16FE8	REMARK
	1	BASE PAN ASS'Y	1	CWD52K1275	←	
	2	COMPRESSOR	1	5JD420XBA22	←	O
	3	BUSHING - COMPRESSOR MOUNT	3	CWH50055	←	
	4	NUT - COMPRESSOR MOUNT	3	CWH561049	←	
	4a	GASKET FOR TERMINAL COVER	3	CWB811017	←	
	5	CRANKCASE HEATER	1	CWA341053	←	
	6	CONDENSER COMPLETE	1	CWB32C3986	←	
	7	HIGH PRESSURE SENSOR	1	CWA501463	←	O
	8	DISCHARGE MUFFLER	1	CWB121014	←	
	9	PRESSURE SWITCH	1	CWA101007	←	
	10	3-WAYS VALVE (GAS)	1	CWB011251	←	O
	11	4-WAYS VALVE	1	CWB001046	←	O
	12	3-WAYS VALVE	1	CWB011292	←	O
	13	STRAINER	3	CWB111032	←	
	15	TERMINAL COVER	1	CWH171039A	←	
	16	NUT - TERMINAL COVER	1	CWH7080300J	←	
	19	ACCUMULATOR	1	CWB131026A	←	
	20	SOUND PROOF MATERIAL	1	CWG302881	←	
	21	SOUND PROOF MATERIAL	1	CWG302266	←	
	22	SOUND PROOF BOARD	1	CWH15K1031	←	
	23	V-COIL COMPLETE (4-WAY VALVE)	1	CWA43C2169J	←	O
	24	V-COIL COMPLETE (MAIN)	1	CWA43C2602	←	O
	25	SENSOR - COMP. (OUTLET TEMP - TH1)	1	CWA50C2730	←	O
	26	SENSOR - COMP. (DISCHARGE TEMP - CN-DIS)	1	CWA50C2576	←	O
	27	SENSOR - COMPLETE - COM TANK (CN-TANK)	1	CWA50C2629	←	O
	27a	SENSOR - COMP. DEFROST TEMP (TH2)	1	CWA50C2577	←	O
	28	CABINET REAR PLATE - COMPLETE	1	CWE02C1059	←	
	29	CONTROL BOARD CASING	1	CWH10K1049	←	
	31	TERMINAL BOARD ASS'Y	1	CWA28K1214	←	O
	38	ELECTRONIC CONTROLLER - NF	1	CWA747838	←	O
	44	ELECTRONIC CONTROLLER - MAIN	1	CWA73C8540R	CWA73C8541R	O
	46	REACTOR (P1)	3	G0C293J00001	←	O
	47	REACTOR (P2)	3	G0C153J00009	←	O
	50	FAN MOTOR BRACKET	1	CWD54K1084	←	
	50a	SCREW - FAN MOTOR BRACKET	8	CWH551040J	←	
	53	FAN MOTOR (UPPER)	1	EHDS83CAC	←	O
	54	FAN MOTOR (BOTTOM)	1	EHDS83DAC	←	O
	54a	SCREW - FAN MOTOR MOUNT	8	CWH551323	←	
	55	PROPELLER FAN ASSY	2	CWH00K1006	←	
	56	NUT	2	CWH561092	←	
	57	CABINET FRONT PLATE	1	CWE061098A	←	
	58	DISCHARGE GRILLE	2	CWE201073	←	
	59	CABINET SIDE PLATE ASSY	1	CWE04K1023A	←	
	60	WIRE NET	1	CWD041103A	←	
	61	CABINET TOP PLATE CO.	1	CWE03C1096	←	
	62	HANDLE	2	CWE161008	←	
	64	PIPE COVER (FRONT)	1	CWD601074A	←	
	65	PIPE COVER (BACK)	1	CWD601075A	←	
	66	CABINET FRONT PLATE CO.	1	CWE06C1091	←	
	68	TUBE ASSY (CAP.TUBE)	1	CWT07K1606	←	
	69	ACCESSORY CO.(DRAIN ELBOW)	1	CWG87C900	←	
	70	EXPANSION VALVE	1	CWB051049	←	
	71	ELECTRO MAGNETIC SWITCH	1	K6C2AGA00002	←	O

SAFETY	REF. NO.	DESCRIPTION & NAME	QTY.	WH-UD14FE8	WH-UD16FE8	REMARK
	72	ELECTRO MAGNETIC SWITCH	1	K6C4E8A00001	←	O
	74	SENSOR - COMP. (CN-TH3)	1	CWA50C3204	←	O
	76	2-WAYS VALVE	1	CWB021637	←	O
	77	V-COIL COMPLETE (2-WAY VALVE)	1	CWA43C2607	←	O
	79	PTC THERMISTORS	1	D4DDG1010001	←	O
	82	ACCESSORY - COMPLETE	1	CWH82C2031	←	
	83	BAG	1	CWG861204	←	
	84	SHOCK ABSORBER	1	CWG712922	←	
	85	BASE BOARD - COMPLETE	1	CWG62C1086	←	
	86	SHOCK ABSORBER	2	CWG712852	←	
	88	C.C.CASE	1	CWG568054	←	

**Note:**

- All parts are supplied from PAPAMY, Malaysia (Vendor Code: 00029488).
- "O" marked parts are recommended to be kept in stock.