

Service Manual

(Mono bloc) Air-to-Water Heatpump System

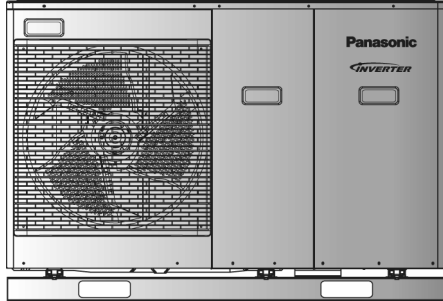

Mono Bloc Unit
WH-MDF06E3E5
WH-MDF09E3E5

⚠ WARNING

This service information is designed for experienced repair technicians only and is not designed for use by the general public. It does not contain warnings or cautions to advise non-technical individuals of potential dangers in attempting to service a product. Products powered by electricity should be serviced or repaired only by experienced professional technicians. Any attempt to service or repair the product or products dealt with in this service information by anyone else could result in serious injury or death.

⚠ PRECAUTION OF LOW TEMPERATURE



In order to avoid frostbite, be assured of no refrigerant leakage during the installation or repairing of refrigerant circuit.

TABLE OF CONTENTS

	PAGE		PAGE
1. Safety Precautions	3	14.4 Expansion Vessel Pre Pressure Checking	62
2. Specifications	5	15. Maintenance Guide	63
2.1 WH-MDF06E3E5	5	16. Troubleshooting Guide	65
2.2 WH-MDF09E3E5	7	16.1 Refrigeration Cycle System	65
3. Features	9	16.2 Relationship Between The Condition Of The Mono Bloc Unit And Pressure And Electric Current	66
4. Location of Controls and Components	10	16.3 Breakdown Self Diagnosis Function	67
4.1 Mono Bloc Unit.....	10	16.4 Error Codes Table.....	68
5. Dimensions	17	16.5 Self-diagnosis Method	70
5.1 Mono Bloc Unit.....	17	17. Disassembly and Assembly Instructions ...	104
6. Refrigeration and Water Cycle Diagram	18	17.1 To Remove The Cabinet Front Plate	104
7. Block Diagram	20	17.2 To Remove The Cabinet Top Plate	104
8. Wiring Connection Diagram	21	17.3 To Remove The Cabinet Rear Plate.....	105
9. Electronic Circuit Diagram	23	17.4 To Remove Pressure Gauge	105
10. Printed Circuit Board	25	17.5 To Remove RCCB	106
10.1 Water System	25	17.6 To Remove Transformer and Electronic Controller Board.....	106
10.2 Refrigerant System	27	17.7 To Remove Pressure Relief Valve and Air Purge Valve	107
11. Installation Instruction Mono Bloc Unit	29	17.8 To Remove Flow Switch	107
11.1 Select the Best Location	31	17.9 To Remove Water Pump	107
11.2 Mono Bloc Unit Installation	31	18. Technical Data	108
11.3 Piping Installation.....	32	18.1 Operation Characteristics	108
11.4 Connect The Cord And Cable To Mono Bloc Unit.....	33	18.2 Heating Capacity Table.....	110
12. Operation and Control	38	18.3 Hydraulic Pump Performance.....	110
12.1 Basic Function	38	19. Exploded View and Replacement Parts List	111
12.2 Water Pump	49	19.1 WH-MDF06E3E5 WH-MDF09E3E5 (Refrigerant System).....	111
12.3 Pump Down Operation	50	19.2 WH-MDF06E3E5 WH-MDF09E3E5 (Water System).....	115
12.4 Flow Switch.....	50		
12.5 Force Heater Mode Operation	50		
12.6 Mono Bloc Unit Safety	51		
12.7 Auto Restart Control	51		
12.8 Indication Panel	51		
12.9 Back-Up Heater Control.....	52		
12.10 Tank Booster Heater Control	52		
12.11 Base Pan Heater Control (Optional).....	53		
12.12 Three Way Valve Control.....	53		
12.13 Sterilization Mode	54		
12.14 Quiet Operation.....	54		
12.15 Anti Freeze Control.....	54		
12.16 Solar Operation (Optional).....	55		
12.17 External Room Thermostat Control (Optional)	58		
13. Protection Control	59		
13.1 Protection Control For All Operations	59		
13.2 Protection Control for Heating Operation	61		
14. Servicing Mode	62		
14.1 Test Run	62		
14.2 Proper Pump Down Procedure.....	62		
14.3 How To Adjust Water Flow Rate.....	62		

1. Safety Precautions













- Read the following “SAFETY PRECAUTIONS” carefully before perform any servicing.
- Electrical work and water installation work must be installed or serviced by a licensed electrician and licensed water system installer respectively. Be sure to use the correct rating and main circuit for the model installed.
- The caution items stated here must be followed because these important contents are related to safety. The meaning of each indication used is as below. Incorrect installation or servicing due to ignoring of the instruction will cause harm or damage, and the seriousness is classified by the following indications.

 WARNING	This indication shows the possibility of causing death or serious injury.
 CAUTION	This indication shows the possibility of causing injury or damage to properties.

- The items to be followed are classified by the symbols:





	This symbol denotes item that is PROHIBITED from doing.
---	---

- Carry out test run to confirm that no abnormality occurs after the servicing. Then, explain to user the operation, care and maintenance as stated in instructions. Please remind the customer to keep the operating instructions for future reference.

 WARNING	
1. Do not modify the machine, part or material during repairing service.	
2. If wiring unit is supplied as repairing part, do not repair or connect the wire even partial wire break. Exchange the whole wiring unit.	
3. Do not wrench the fasten terminal. Pull it out or insert it straightly.	
4. Do not install Mono bloc unit near handrail of veranda. When installing Mono bloc unit at veranda of high rise building, child may climb up to Mono bloc unit and cross over the handrail and causing accident.	
5. Do not use unspecified cord, modified cord, join cord or extension cord for power supply cord. Do not share the single outlet with other electrical appliances. Poor contact, poor insulation or over current will cause electrical shock or fire.	
6. Do not tie up the power supply cord into a bundle by band. Abnormal temperature rise on power supply cord may happen.	
7. Do not insert your fingers or other objects into the unit, high speed rotating fan may cause injury.	
8. Do not sit or step on the unit, you may fall down accidentally.	
9. Keep plastic bag (packaging material) away from small children, it may cling to nose and mouth thus causing suffocation.	
10. Do not use pipe wrench to install refrigerant pipe. Using pipe wrench may deform the pipes and cause unit malfunction.	
11. Do not purchase unauthorized electrical parts for installation, service, maintenance and etc.. They might cause electrical shock or fire.	
12. Do not modify the wiring of Mono bloc unit for installation of other components (i.e. heater, etc). Overloaded wiring or wire connection points may cause electrical shock or fire.	
13. For electrical work, follow local wiring standard, regulation and this installation instruction. An independent circuit and single outlet must be used. If electrical circuit capacity is not enough or defect found in electrical work, it will cause electrical shock or fire.	
14. For water circuit installation work, follow to relevant European and national regulations (including EN61770) and local plumbing and building regulation codes.	
15. Must engage an authorized dealer or specialist for installation. If installation is defective, it will cause water leakage, electrical shock or fire.	
16. Install according to this installation instructions strictly. If installation is defective, it will cause water leakage, electrical shock or fire.	
17. Only use the supplied or specified installation parts. Else, it may causes Mono bloc unit vibrate, fall, water leakage, electrical shock or fire.	
18. Install at a flat, strong and firm location which is able to withstand the Mono bloc unit's weight. If the location is slanting, or strength is not enough the set will fall and cause injury.	

19. This equipment is strongly recommended to be installed with Residual Current Device (RCD) on-site according to the respective national wiring rules or country-specific safety measures in terms of residual current.
20. The unit is only for use in a closed water system. Utilization in an open water system may lead to excessive corrosion of the water piping and risk of incubating bacteria colonies, particularly Legionella, in water.
21. If there is any doubt about the installation procedure or operation, always contact the authorized dealer for advice and information.
22. Select a location where in case of water leakage, the leakage will not cause damage to other properties.
23. When installing electrical equipment at wooden building of metal lath or wire lath, in accordance with electrical facility standard, no electrical contact between equipment and building is allowed. Insulator must be installed in between.
24. This installation may be subjected to building regulation approval applicable to respective country that may require to notify the local authority before installation.
25. Any work carried out on the Mono bloc unit after removing the front panel which is secured by screws, must be carried out under the supervision of authorized dealer and licensed installation contractor.
26. This unit must be properly earthed, the electrical earth must not be connected to a gas pipe, water pipe, the earth of a lightning rod or a telephone. Otherwise there is a danger of electrical shock in the event of an insulation breakdown or electrical earth fault in the Mono bloc unit.
27. When replace refrigeration circuit components, confirm on usage of specified refrigerant type. Using of refrigerant other than the specified type may cause product damage, burst and injury etc.
28. Do not add or replace refrigerant other than the specified type. Equipment may damage or deteriorate in safety due to usage of other refrigerant.

 **CAUTION**

1. Do not install the Mono bloc unit in areas where there is a risk of flammable gas leakage. There is a risk of fire if flammable gas accumulates near or around the Mono bloc unit.	
2. Do not release refrigerant during piping work for installation, re-installation and during repairing a refrigeration parts. Take care of the liquid refrigerant, it may cause frostbite.	
3. Make sure the power supply cord does not contact with hot part (i.e. water piping). High temperature may cause insulator of power supply cord damage hence electrical shock or fire.	
4. Do not touch the sharp aluminum fins or edges of metal parts. If you are required to handle sharp parts during installation or servicing, please wear hand glove. <u>Sharp parts may cause injury.</u>	
5. Do not apply excessive force to water pipes that may damage the pipes. If water leakage occurs, it will cause flooding and damage to other properties.	
6. Carry out drainage piping as mentioned in installation instructions. If drainage is not perfect, water leakage may happen and may cause damage to properties of the user.	
7. The piping installation work must be flushed before the Mono bloc unit is connected to remove contaminants. Contaminants may damage the Mono bloc unit components.	
8. Select an installation location where it is accessible for maintenance.	
9. Power supply connection to Mono bloc unit. <ul style="list-style-type: none"> • Power supply point should be in easily accessible place for power disconnection in case of emergency. • Must follow local national wiring standard, regulation and this installation instruction. • Strongly recommended to make permanent connection to a circuit breaker. It must be a double pole switch with a minimum 3.0 mm gap. <ul style="list-style-type: none"> - Use approved 30A circuit breaker for power supply 1 - For electrical heater connection to main for power supply 2 (either Ⓐ or Ⓑ) <ul style="list-style-type: none"> Ⓐ Use approved 15A/16A circuit breaker (Backup Heater only) Ⓑ Use approved 30A circuit breaker (Backup Heater + Booster Heater) 	
10. Ensure the correct polarity is maintained throughout all wiring. Otherwise, it will cause electrical shock or fire.	
11. After installation, the installer is obliged to verify correct operation of the Mono bloc unit. Check the connection point for water leakage during test run. If leakage occurs, it will cause damage to other properties.	
12. Installation work. Four or more people are required to carry out the installation work. The weight of Mono bloc unit might cause injury if carried by less than four people.	

2. Specifications

2.1 WH-MDF06E3E5

Item		Unit	Refrigerant System	
Performance Test Condition			EN 14511	
Heating Capacity	Condition (Ambient/Water)		A7W35	A2W35
	kW		6.00	5.00
	BTU/h		20500	17100
	kcal/h		5160	4300
COP	W/W		4.48	3.45
	kcal/hW		3.85	2.97
Air Flow	m ³ /min (ft ³ /min)		46.7 (1649)	
Refrigeration Control Device			Expansion Valve	
Refrigeration Oil	cm ³		FV50S (900)	
Refrigerant (R410A)	kg (oz)		1.45 (51.2)	
Pipe Diameter	Liquid	mm (inch)	9.52 (3/8)	
	Gas	mm (inch)	15.88 (5/8)	
Compressor	Type		Hermetic Motor (Rotary)	
	Motor Type		Brushless (4-poles)	
	Rated Output	kW	1.70	
Fan	Type		Propeller Fan	
	Material		PP	
	Motor Type		Induction (8-poles)	
	Input Power	W	—	
	Output Power	W	60	
	Fan Speed	rpm	580	
Heat Exchanger	Fin material		Aluminium (Pre Coat)	
	Fin Type		Corrugated Fin	
	Row × Stage × FPI		2 × 30 × 17	
	Size (W × H × L)	mm	38.1 × 762 × 903.8 873.8	

Item		Unit	Mono Bloc Unit	
Dimension	Height	mm (inch)	865 (34 - 1/16)	
	Width	mm (inch)	1283 (50 - 17/32)	
	Depth	mm (inch)	320 (12 - 5/8)	
Net Weight		kg (lbs)	112 (247)	
Noise Level		dB-A	47	-
		Power Level dB	65	-
Power Source (Phase, Voltage, Cycle)		ø	Single	
		V	230	
		Hz	50	
Input Power		kW	1.34	1.45
Maximum Input Power For Mono Bloc Unit		kW	4.48	
Power Supply 1: Phase (ø) / Max. Current (A) / Max. Input Power (W)			Single / 20.5 / 4.48k	
Power Supply 2: Phase (ø) / Max. Current (A) / Max. Input Power (W)			Single / 26.0 / 6.00k	
Power Supply 3: Phase (ø) / Max. Current (A) / Max. Input Power (W)			- / - / -	
Starting Current		A	6.1	
Running Current		A	6.1	6.6
Maximum Current For Mono Bloc Unit		A	20.5	
Power Factor		%	95	

Item		Unit	Mono Bloc Unit
Power factor means total figure of compressor and outdoor fan motor.			
Power Cord	Number of core		-
	Length	m (ft)	-
Thermostat			Electronic Control
Protection Device			Electronic Control

Item		Unit	Water System
Performance Test Condition			EN 14511
Operation Range	Outdoor Ambient	°C	-20 ~ 35
	Water Outlet	°C	25 ~ 55
Internal Pressure Differential		kPa	22.4
Refrigerant Pipe Diameter	Liquid	mm (inch)	9.52 (3/8)
	Gas	mm (inch)	15.88 (5/8)
Water Pipe Diameter	Inlet	mm (inch)	30 (1-3/16)
	Outlet	mm (inch)	30 (1-3/16)
Water Drain Hose Inner Diameter		mm (inch)	15.00 (19/32)
Pump	Type		Canned (WILO stratos PARA)
	Speed	rpm	1200 ~ 4450
	Input Power	W	56
Hot Water Coil	Type		Brazed Plate
	No. of Plates		48
	Size (W x H x L)	mm	93 x 81 x 325
	Water Flow Rate	l/min (m ³ /h)	17.2 (1.0)
Pressure Relief Valve Water Circuit		kPa	Open: 300, Close: 265 and below
Flow Switch			Magnetic Lead Switch
Protection Device		A	Residual Current Circuit Breaker (40)
Expansion Vessel	Volume	l	6
	MWP	bar	3
Capacity of Integrated Electric Heater		kW	3.00

Note:

- Heating capacities are based on outdoor air temperature of 7°C Dry Bulb (44.6°F Dry Bulb), 6°C Wet Bulb (42.8°F Wet Bulb) with controlled water inlet temperature of 30°C and water outlet temperature of 35°C.
- Specification are subjected to change without prior notice for further improvement.

2.2 WH-MDF09E3E5

Item		Unit	Refrigerant System	
Performance Test Condition			EN 14511	
Heating Capacity	Condition (Ambient/Water)		A7W35	A2W35
	kW		9.00	7.00
	BTU/h		30700	23900
	kcal/h		7740	6020
COP	W/W		4.15	3.04
	kcal/hW		3.57	2.62
Air Flow	m ³ /min (ft ³ /min)		51.6 (1822)	
Refrigeration Control Device			Expansion Valve	
Refrigeration Oil	cm ³		FV50S (900)	
Refrigerant (R410A)	kg (oz)		1.45 (51.2)	
Pipe Diameter	Liquid	mm (inch)	9.52 (3/8)	
	Gas	mm (inch)	15.88 (5/8)	
Compressor	Type		Hermetic Motor (Rotary)	
	Motor Type		Brushless (4-poles)	
	Rated Output	kW	1.70	
Fan	Type		Propeller Fan	
	Material		PP	
	Motor Type		Induction (8-poles)	
	Input Power	W	—	
	Output Power	W	60	
	Fan Speed	rpm	640	
Heat Exchanger	Fin material		Aluminium (Pre Coat)	
	Fin Type		Corrugated Fin	
	Row × Stage × FPI		2 × 30 × 17	
	Size (W × H × L)	mm	38.1 × 762 × 903.8 873.8	

Item		Unit	Mono Bloc Unit	
Dimension	Height	mm (inch)	865 (34 - 1/16)	
	Width	mm (inch)	1283 (50 - 17/32)	
	Depth	mm (inch)	320 (12 - 5/8)	
Net Weight		kg (lbs)	112 (247)	
Noise Level		dB-A	49	-
		Power Level dB	67	-
Power Source (Phase, Voltage, Cycle)		ø	Single	
		V	230	
		Hz	50	
Input Power		kW	2.17	2.30
Maximum Input Power For Mono Bloc Unit		kW	5.01	
Power Supply 1: Phase (ø) / Max. Current (A) / Max. Input Power (W)			Single / 22.9 / 5.01k	
Power Supply 2: Phase (ø) / Max. Current (A) / Max. Input Power (W)			Single / 26.0 / 6.00k	
Power Supply 3: Phase (ø) / Max. Current (A) / Max. Input Power (W)			- / - / -	
Starting Current		A	9.9	
Running Current		A	9.9	10.5
Maximum Current For Mono Bloc Unit		A	22.9	
Power Factor		%	95	

Item		Unit	Mono Bloc Unit
Power factor means total figure of compressor and outdoor fan motor.			
Power Cord	Number of core		-
	Length	m (ft)	-
Thermostat			Electronic Control
Protection Device			Electronic Control

Item		Unit	Water System
Performance Test Condition			EN 14511
Operation Range	Outdoor Ambient	°C	-20 ~ 35
	Water Outlet	°C	25 ~ 55
Internal Pressure Differential		kPa	47.4
Refrigerant Pipe Diameter	Liquid	mm (inch)	9.52 (3/8)
	Gas	mm (inch)	15.88 (5/8)
Water Pipe Diameter	Inlet	mm (inch)	30 (1-3/16)
	Outlet	mm (inch)	30 (1-3/16)
Water Drain Hose Inner Diameter		mm (inch)	15.00 (19/32)
Pump	Type		Canned (WILO stratos PARA)
	Speed	rpm	1200 ~ 4450
	Input Power	W	66
Hot Water Coil	Type		Brazed Plate
	No. of Plates		48
	Size (W x H x L)	mm	93 x 81 x 325
	Water Flow Rate	l/min (m ³ /h)	25.8 (1.6)
Pressure Relief Valve Water Circuit		kPa	Open: 300, Close: 265 and below
Flow Switch			Magnetic Lead Switch
Protection Device		A	Residual Current Circuit Breaker (40)
Expansion Vessel	Volume	l	6
	MWP	bar	3
Capacity of Integrated Electric Heater		kW	3.00

Note:

- Heating capacities are based on outdoor air temperature of 7°C Dry Bulb (44.6°F Dry Bulb), 6°C Wet Bulb (42.8°F Wet Bulb) with controlled water inlet temperature of 30°C and water outlet temperature of 35°C.
- Specification are subjected to change without prior notice for further improvement.

3. Features

- **Inverter Technology**
 - Energy saving
- **High Efficiency**
- **Compact Design**
- **Environment Protection**
 - Non-ozone depletion substances refrigerant (R410A)
- **Easy to use remote control**
- **Weekly Timer setting**
- **Quality Improvement**
 - Random auto restart after power failure for safety restart operation
 - Gas leakage protection
 - Prevent compressor reverse cycle
 - Inner protector to protect compressor
- **Serviceability Improvement**
 - Breakdown Self Diagnosis function
 - System Status Check Buttons for servicing purpose
 - System Service Mode Button for servicing purpose
 - Front maintenance design for mono bloc unit
- **Operation Condition**

		Water outlet temperature (°C)	Ambient temperature (°C)
HEATING	Maximum	55	35
	Minimum	25	-20

NOTICE : When the outdoor temperature is out of the above temperature range, the heating capacity will drop significantly and mono bloc unit might stop for protection control.

4. Location of Controls and Components

4.1 Mono Bloc Unit

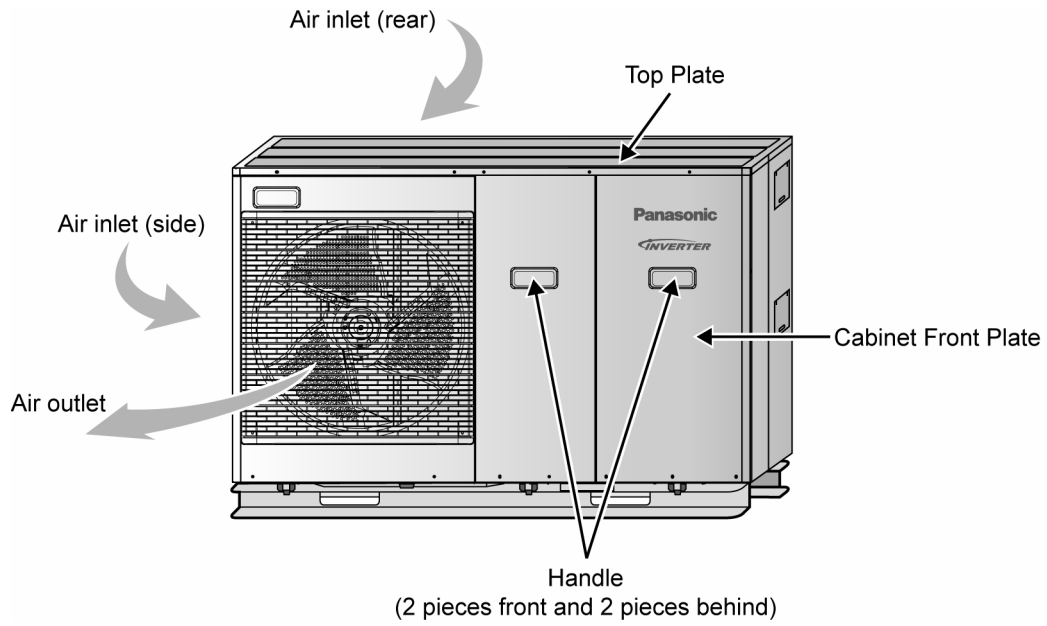

4.1.1 Main Components

<Top View>

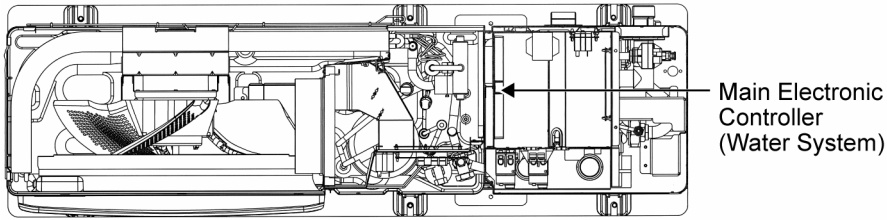

<Front View>

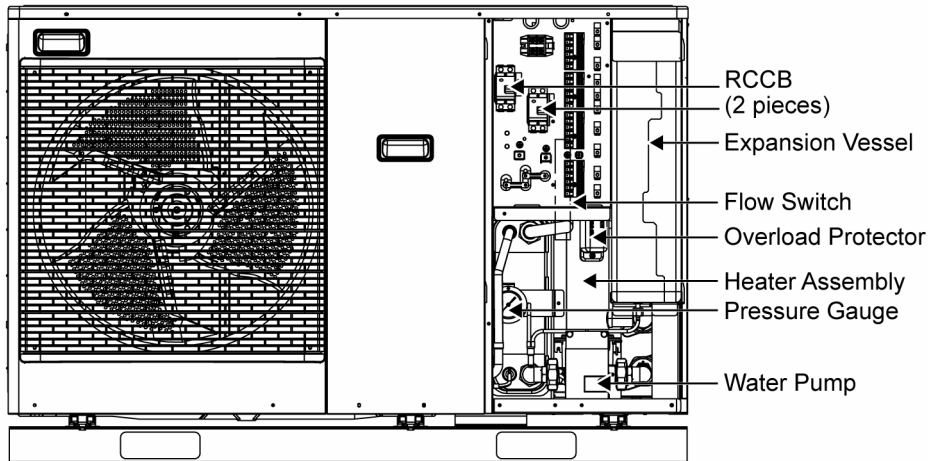

<Side View>

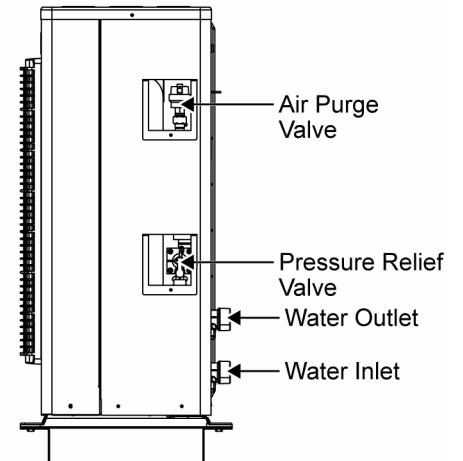

Water pump:	The pump circulates the water in the water circuit.
Pressure gauge:	The manometer allows read out of the water pressure in the water circuit.
Flow switch:	The flow switch checks the flow in the water circuit and protects the heat exchanger against high pressure built-up and the pump against damage.
Pressure relief valve:	The pressure relief valve prevents excessive water pressure in the water circuit (> 300kPa).
Electric Heater:	Additional heating capacity to the system when water and ambient temp is low.
Expansion Vessel:	Storage for excessive water.

4.1.2 Location of Control

4.1.2.1 Remote Control

The user interface allows the installer and user to setup, use and maintain the unit.

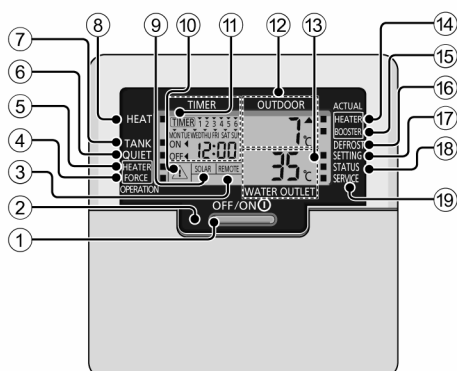

- ① **OFF/ON Button**
This button starts or stops the mode operation function of the unit.
- ② **Operation LED**
This LED indicates the unit is in operation.
- ③ **External Thermo Controller Connected Display**
This LCD show the external thermo controller connected display.
- ④ **Force Heater Request OFF/ON Indicator**
This icon indicates force heater mode operation.
- ⑤ **Backup Heater Enabled/Disabled Indicator**
This icon indicates backup heater mode operation.
- ⑥ **Quiet Mode Indicator**
This icon indicates quiet mode operation.
- ⑦ **Tank Mode Indicator**
This icon indicates tank mode operation.
- ⑧ **Heat Mode OFF/ON Indicator**
This icon indicates heating mode operation.
- ⑨ **Solar Display**
This LCD show the solar display.
- ⑩ **Caution (Tank Temperature above 60°C) Indicator**
This LCD show Caution display.
- ⑪ **Timer/Clock Setting Display**
This LCD show the weekly schedule timer setting and clock display.
- ⑫ **Outdoor Ambient Temperature Display**
This LCD show the outdoor ambient temperature.
- ⑬ **Water Outlet Temperature Display**
This LCD show the water outlet temperature.
- ⑭ **Backup Heater Actual (OFF/ON) Indicator**
This icon indicates backup heater actual operation.
- ⑮ **Booster Heater Actual (OFF/ON) Indicator**
This icon indicates booster heater actual operation.
- ⑯ **System Defrost Operation OFF/ON Indicator**
This icon indicates the system defrost operation request OFF/ON display.
- ⑰ **System Setting Mode OFF/ON Indicator**
This icon indicates the system setting mode request OFF/ON display.
- ⑱ **System Status Check Mode OFF/ON Indicator**
This icon indicates the status check mode request OFF/ON display.
- ⑲ **System Service Mode OFF/ON Indicator**
This icon indicates the system service mode request OFF/ON display.

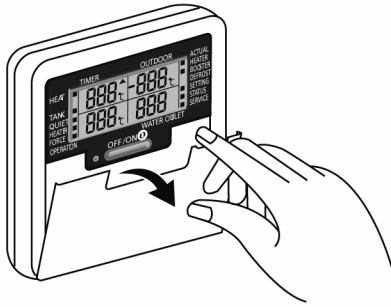

Open cover for buttons selections.

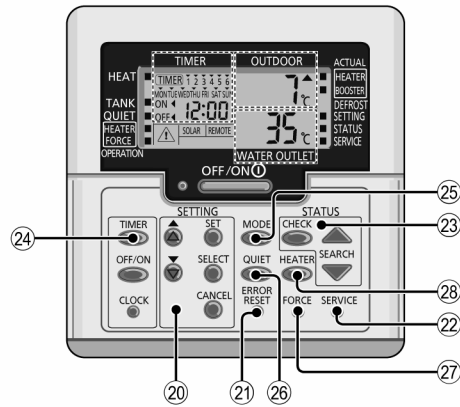

⑳ System Setting Mode Buttons

These setting button can change the temperature range of setup setting mode selection. Perform the steps below to set preferred temperature range.

STEP 1: Press SET button for 5 seconds to enter setting mode.

STEP 2: Press upward or downward button to choose the 7 of the parameter as below for change the temperature range.

- 1) Low outdoor ambient set temperature
(Selection range: $-15^{\circ}\text{C} \sim 15^{\circ}\text{C}$).
- 2) High outdoor ambient set temperature
(Selection range: $-15^{\circ}\text{C} \sim 15^{\circ}\text{C}$).
- 3) Water outlet set temperature at low outdoor ambient temperature
(Selection range: $25^{\circ}\text{C} \sim 55^{\circ}\text{C}$).
- 4) Water outlet set temperature at high outdoor ambient temperature
(Selection range: $25^{\circ}\text{C} \sim 55^{\circ}\text{C}$).
- 5) Set temperature for turning OFF heating operation (Selection range: $5^{\circ}\text{C} \sim 35^{\circ}\text{C}$).
- 6) Outdoor ambient set temperature for turning ON heater operation (Selection range: $-15^{\circ}\text{C} \sim 20^{\circ}\text{C}$).
- 7) Sanitary tank set temperature (Selection range: $40^{\circ}\text{C} \sim 75^{\circ}\text{C}$).

STEP 3: Press SELECT button to enter selected parameter.

STEP 4: Press upward or downward button to set desired temperature.

STEP 5: Press SET button again to confirm the setting.

Note: Repeat steps 2 to 5 to set other parameters.

STEP 6: Press CANCEL button or wait 30 seconds to exit setting mode.

Water Temperature Thermo Shift Setting

Perform the steps below to set the desired shift temperature.

STEP 1: Press SET button within 5 seconds.

STEP 2: Press SELECT button to enter the setting temperature.

STEP 3: Press upward or downward button to set desired temperature (Selection range: $-5^{\circ}\text{C} \sim 5^{\circ}\text{C}$).

STEP 4: Press SET button again to confirm the setting.

STEP 5: Press CANCEL button or wait 30 seconds to exit setting.

②① **Error Reset Button**

This button is to reset the remote control and system error code.

②② **System Service Mode Button**

②③ **System Status Check Button**

This button is to check the various mode status.

Perform the steps below to check the selection status.

STEP 1: Press CHECK button for 5 seconds to enter status mode.

STEP 2: Press SEARCH Upward or Downward buttons for checking below value.

1. Compressor running frequency

2. Error history

3. Water inlet temperature

4. Tank Temperature

STEP 3: Press CANCEL button at setting mode or wait 30 seconds to exit status check.

②④ **Timer Setting Group Buttons**

This button is to set weekly timer and clock-time combine with setting button.

Perform the steps below to setting the current day and time.

STEP 1: Press CLOCK button.

STEP 2: Press SETTING Upward or Downward buttons to set current day.

STEP 3: Press SET button to confirm.

STEP 4: Repeat STEP 2 and 3 to set the current time.

Note: The current time that has been set will be the standard time for all the Timer Operations.

②⑤ **Operation Mode Button**

This button is to set operation mode.

The mode does the following transition by button operation.

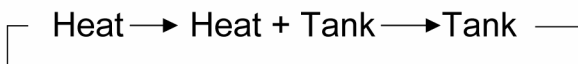

②⑥ **Quiet Operation Button**

This button is to enjoy quiet environment by reduces mono bloc unit noise.

②⑦ **Force Heater Mode Button**

This button is to select force heater mode operation.

Press OFF/ON button to stop the force heater mode operation.

②⑧ **Backup Heater Enabling Button**

This button is to select backup heater mode operation.

4.1.3 Weekly Timer Setting

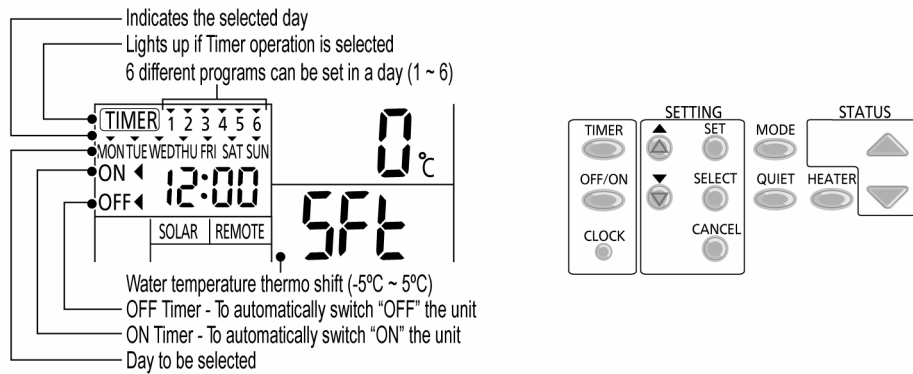

Function	Step
Enter timer mode	Press .
Set day & time	<ol style="list-style-type: none"> Press or to select your desired day. Press to confirm. "1" will be blinking, press to set program 1. Press to select ON or OFF timer. Press or to select your desired time. You can set , , and desired shift temperature with timer. Press to confirm program 1. The selected day will be highlighted with . • After 2 seconds, the display will move to the next program. Repeat steps 4 to 7 to set programs 2 to 6. • During timer setup, if no button is pressed within 30 seconds, or if the button is pressed the setting at that moment is confirmed and timer setup is ended.
Add/Modify timer	Repeat the steps above.
Disable timer	Press , then press .
Enable timer	Press , then press .
Check timer	<ol style="list-style-type: none"> Press . Press or until your desired day is shown, press to confirm your selection. Press or to check the set programs.
Cancel timer	<ol style="list-style-type: none"> Press . Press or until your desired day is shown, press to confirm your selection. Press to enter program setting. Press or until your desired program is shown. Press to cancel the program.

Notes:

- You can set the Timer for each day of the week (Monday to Sunday) with 6 programs per day.
- When the unit is switched on by the ON TIMER, it will use the previously set temperature to control the water outlet temperature.
- Same timer program cannot be set in the same day.
- You may also select collective days with same timer setting.
- Promotes energy saving by allowing you to set up to 6 programs in any given day.

4.1.4 Setting Up The Special Functions

- After initial installation, you can manually adjust the settings. The initial setting remains active until the user changes it.
- The remote control can be used for multiple installations. Some functions may not be applicable to your unit.
- Ensure the operation LED is in OFF condition before setting.

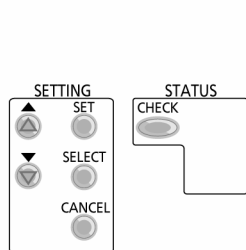

1. Press and simultaneously for 5 seconds to enter special setting mode. "SETTING" and "STATUS" indicator is ON.
2. Press or to browse functions.
3. Press to enter function.
4. Press or to enable YES or disable NO function, or set other options.
5. Press to confirm.

Set	Remote Control's Display	Description
1	rooñ con	External Thermo Controller (YES / NO) To set external thermo controller connection.
2	HEATER CAP	Backup Heater Capacity Selection (3kW / 6kW / 9kW) To reduce the heater power whenever unnecessary. Options vary depending on model.
3	Ant, FrE	Water System Freeze Prevention Function (YES / NO) To activate or deactivate water system freeze prevention function when unit is OFF.
4	TANK con	Tank Connection (YES / NO) To set tank connection. Note: If select "Tank connection" is "NO", Set 5 ~ 14 are skipped.
5	SOLAR PrY	Solar Priority (YES / NO) To choose the solar use for water tank heat up.
6	HEAT PrY	Heating Priority (YES / NO) To choose the room heating as priority during HEAT + TANK mode. Note: If select "Heating priority" is "YES", Set 7 ~ 8 are skipped.
7	HEAT int	Heating operation Interval Set To set timer for Heat mode during HEAT + TANK mode (0.5hour ~ 10 hours).
8	TANK int	Tank Heat-up Interval Set To set timer for Tank during HEAT + TANK mode (5minutes ~ 1hour 35minutes).
9	BOOSTER htr	Booster Heater Function (YES/NO) To activate or deactivate tank booster heater function. Note: If select "Booster heater function" is "NO", Set 10 is skipped.
10	BOOSTER dLy	Booster Heater Delay Timer Set To set delay timer for booster heater to ON if water tank temperature is not reached (20minutes ~ 1hour 35minutes).
11	StrL Fun	Sterilization (YES/NO) To set sterilization, if required. Note: If select "Sterilization" is "NO", set 12 ~ 14 are skipped.
12	Str	Sterilization Day & Time Set To set timer for sterilization (only once a week, will operate even in standby condition).
13	StrL bo	Sterilization Temperature Set To set temperature for sterilization function (40°C ~ 75°C).
14	Str oPr	Sterilization Continue Time To set timer to maintain heating temperature in order to complete the sterilization function (5minutes ~ 1hour).

- Do not use the system during sterilization to prevent scalding or overheat during shower.
- The sterilization function field settings must be configured by the authorized dealer according to local laws and regulation.
- The sterilization set temperature may not achieve if tank booster heater function is deactivated.

5. Dimensions

5.1 Mono Bloc Unit

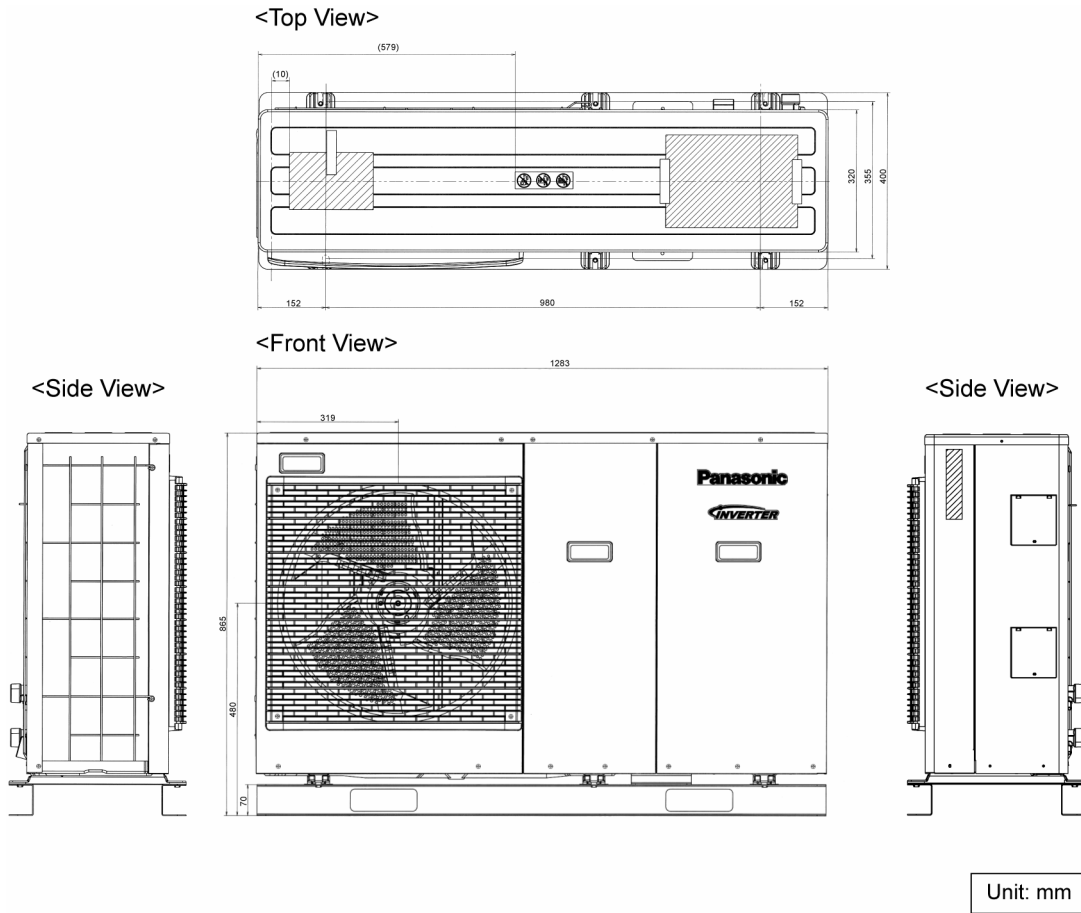

6. Refrigeration and Water Cycle Diagram

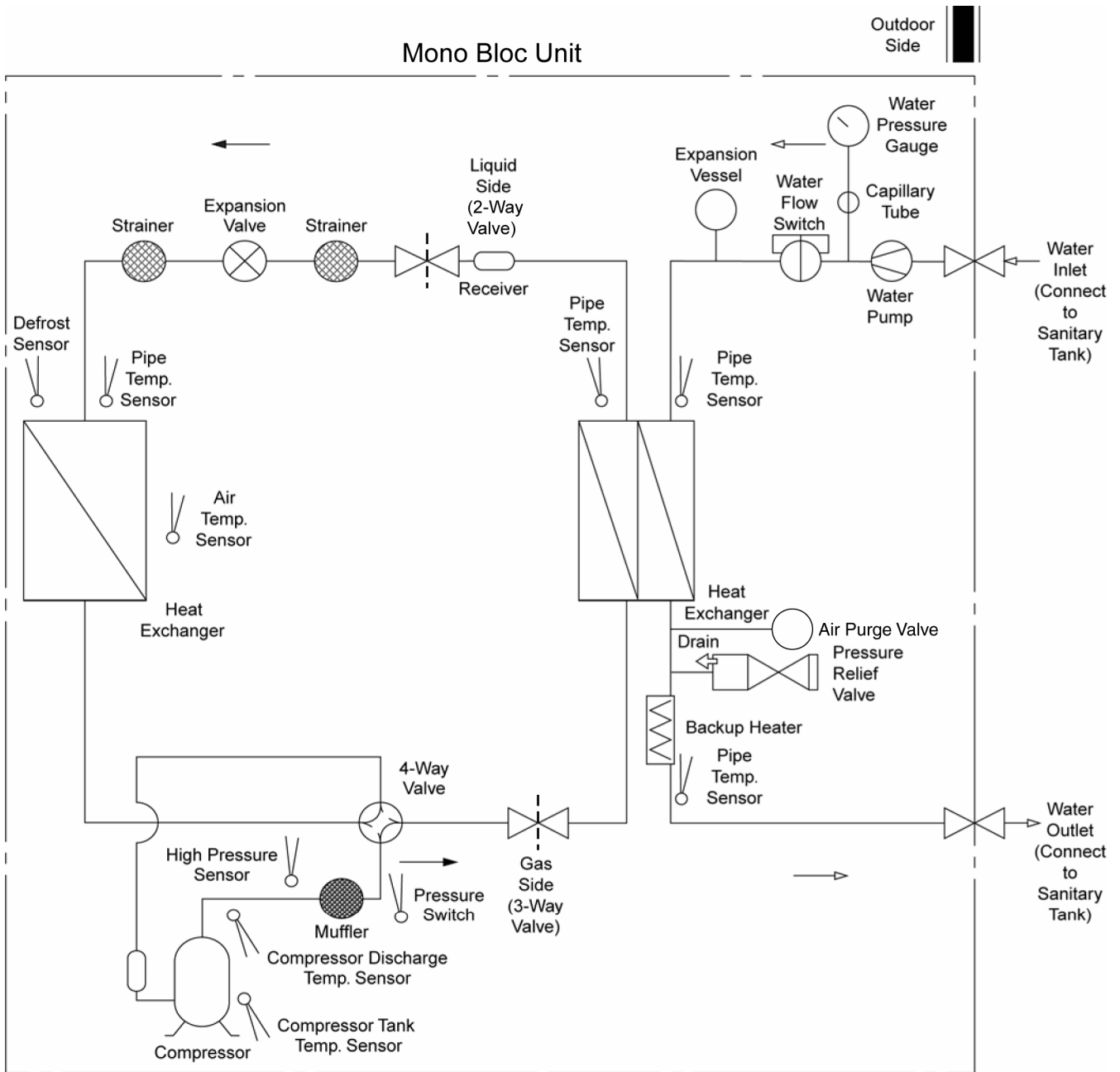

—▶ Refrigerant Cycle (Heating)
 —▷ Water Cycle

Indoor
Side

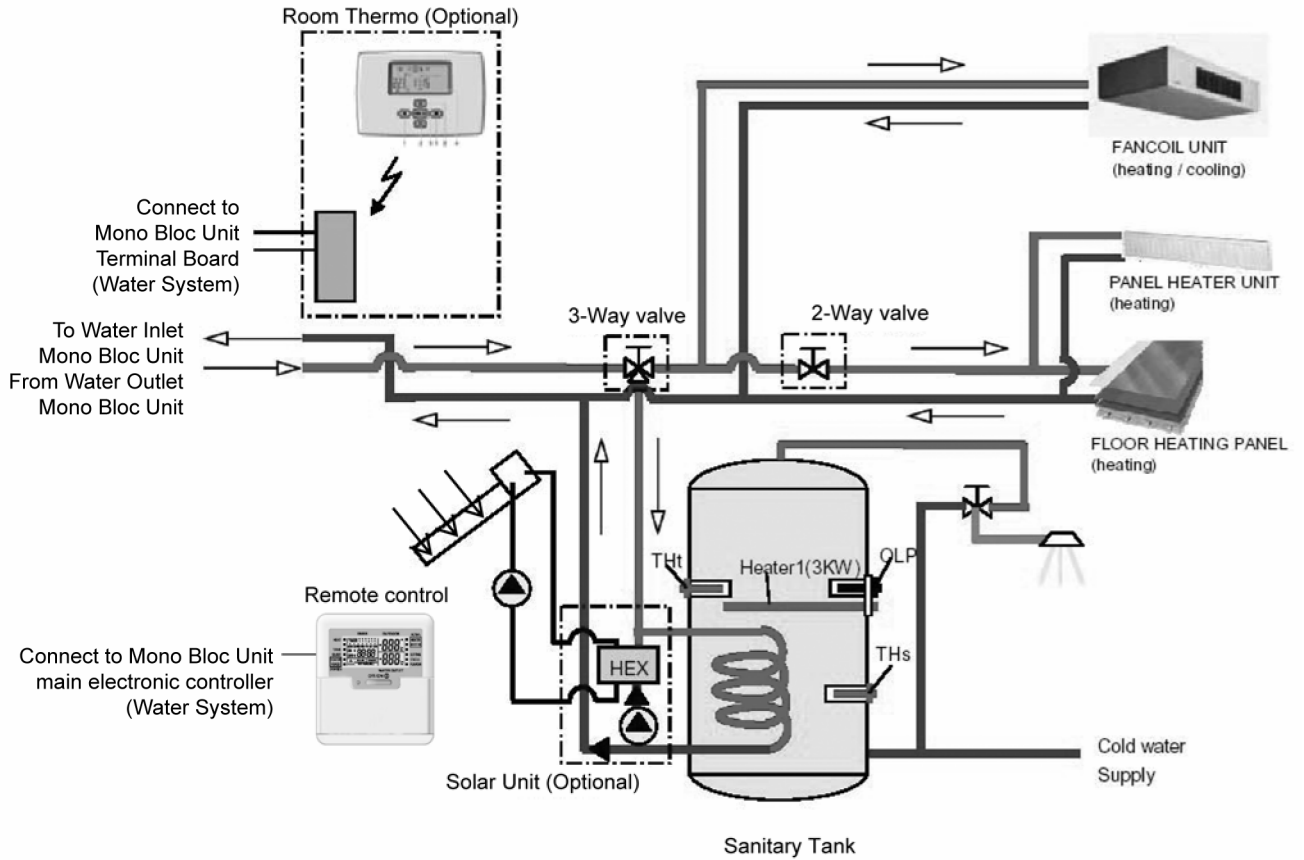

7. Block Diagram

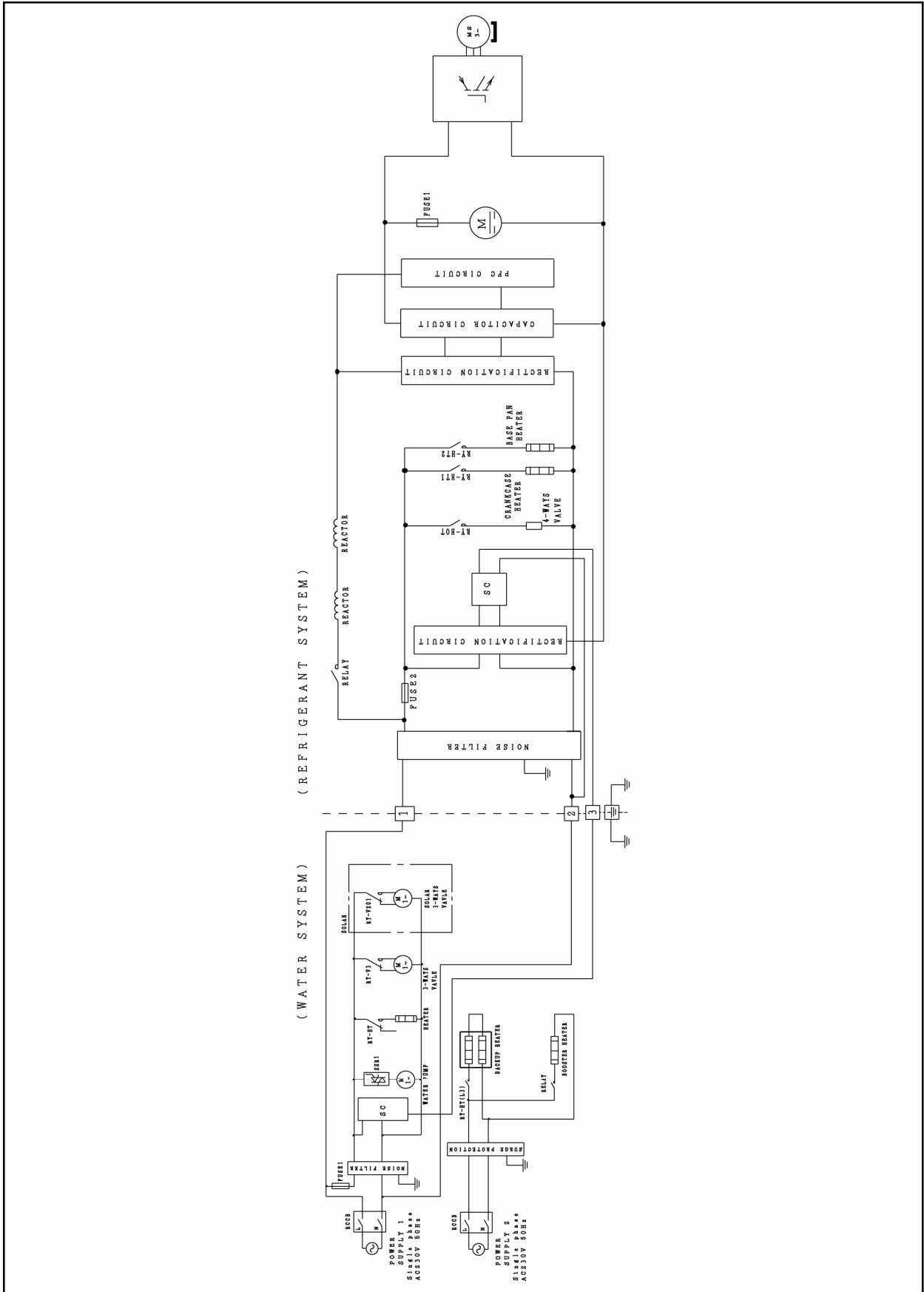

8. Wiring Connection Diagram

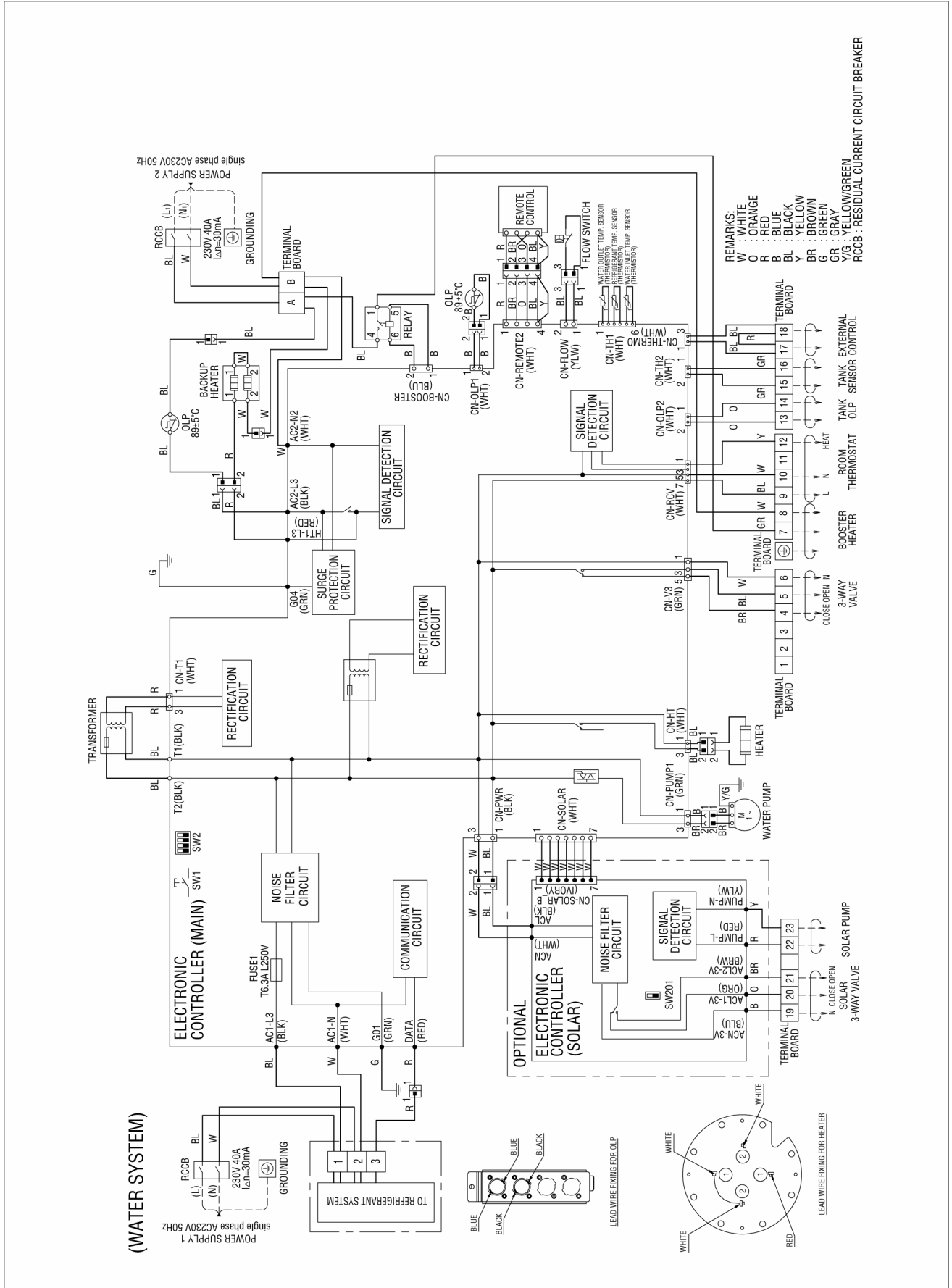

(REFRIGERANT SYSTEM)

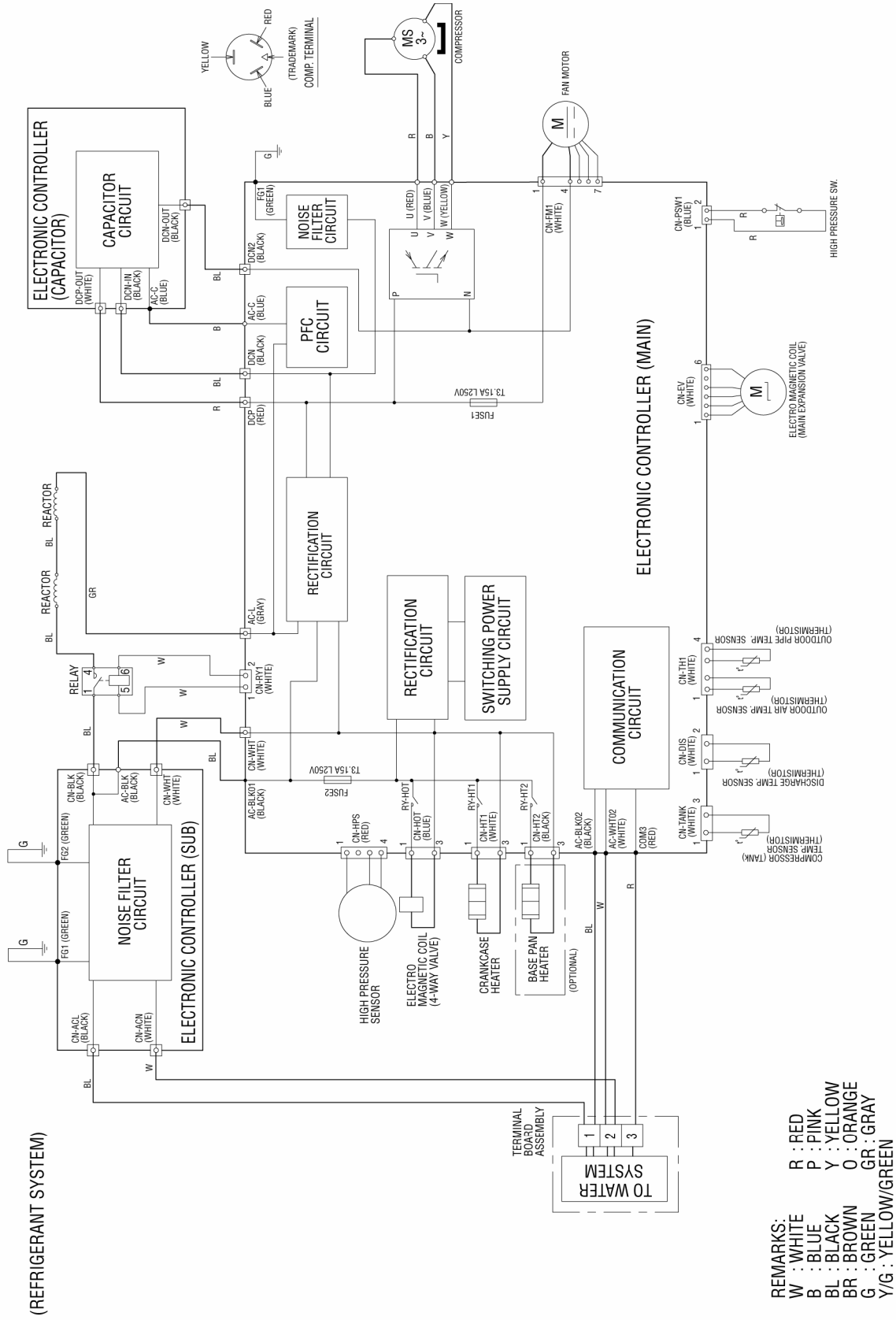

9. Electronic Circuit Diagram

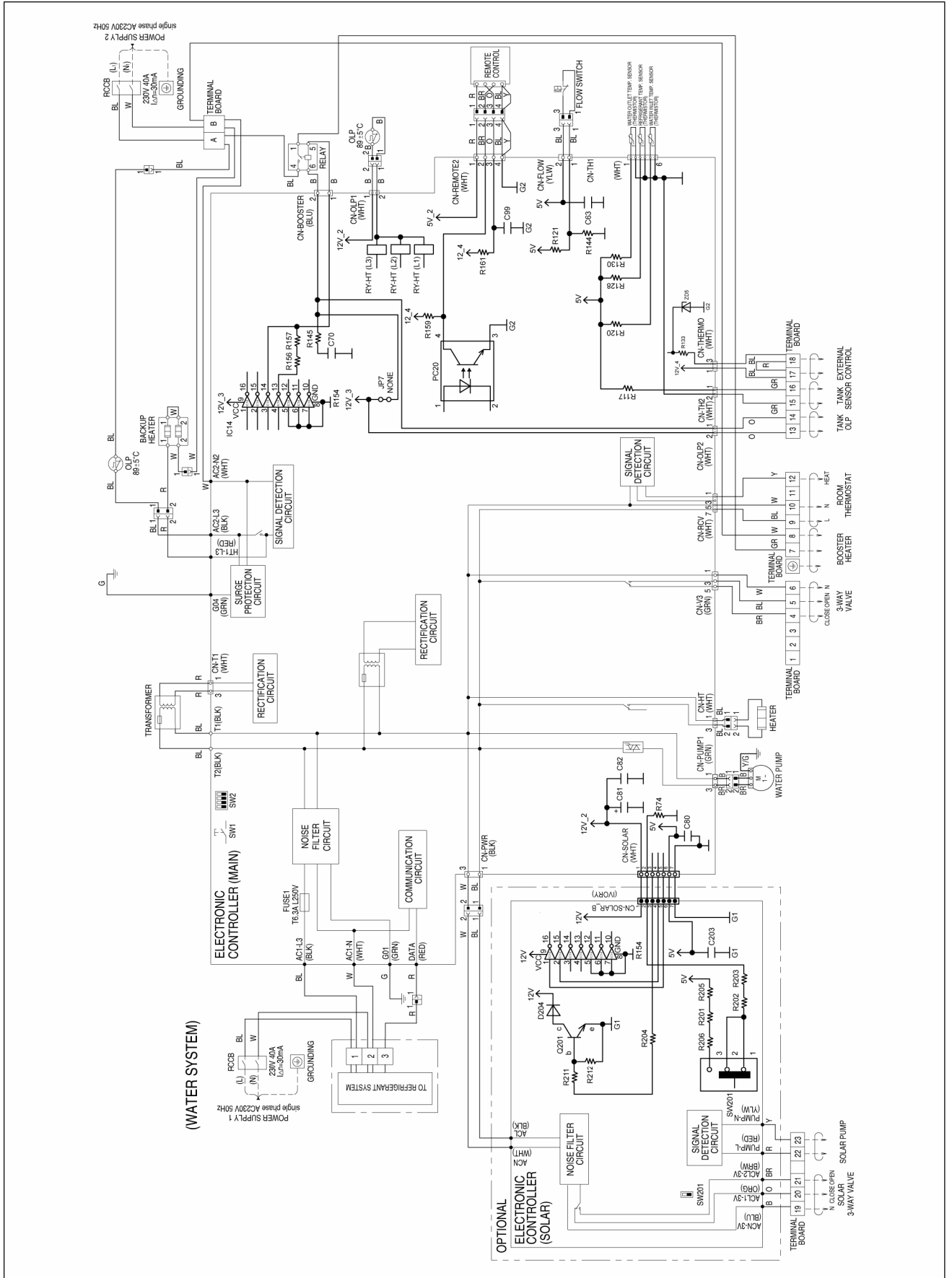

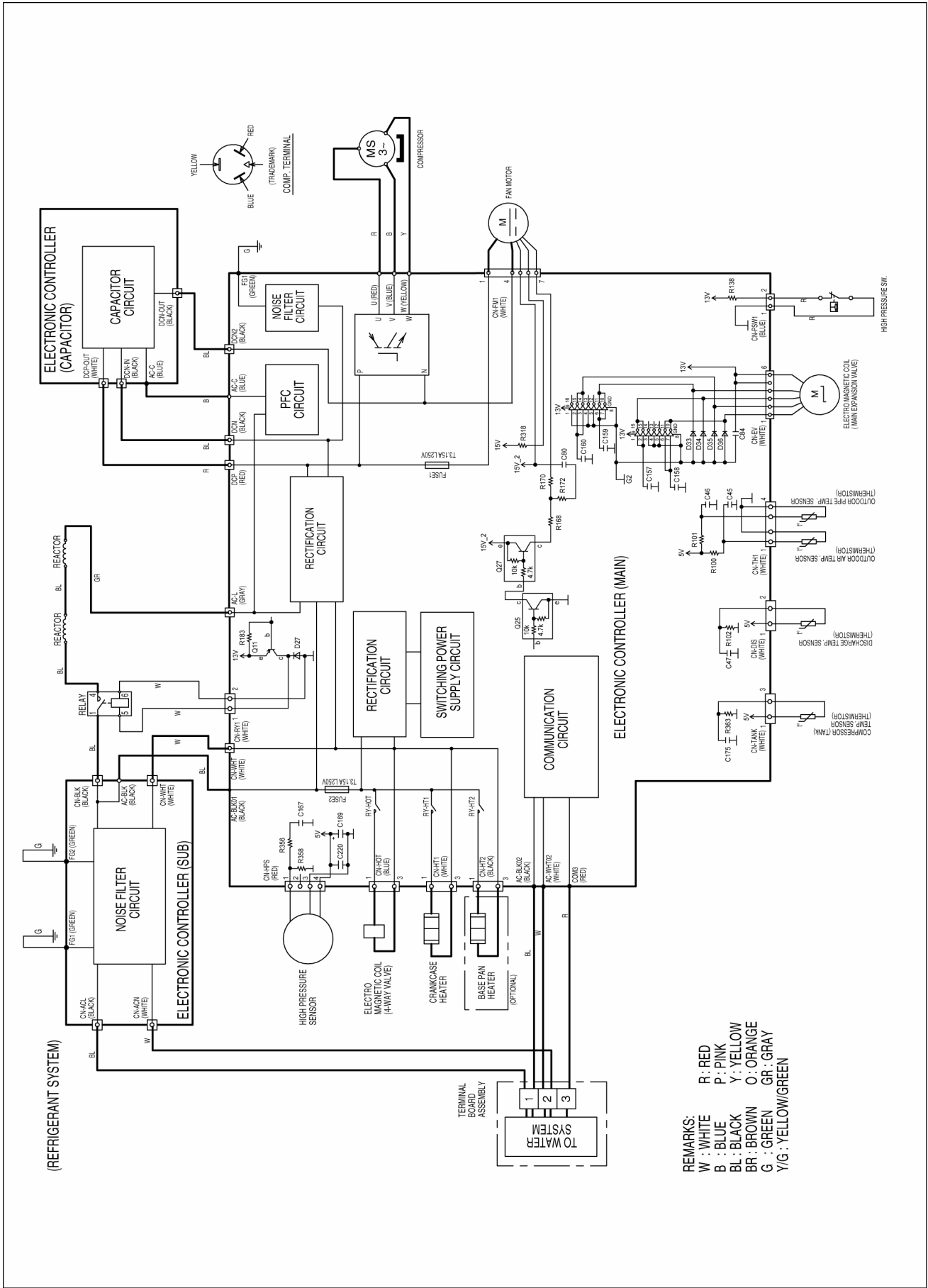

10. Printed Circuit Board

10.1 Water System

10.1.1 Main Printed Circuit Board

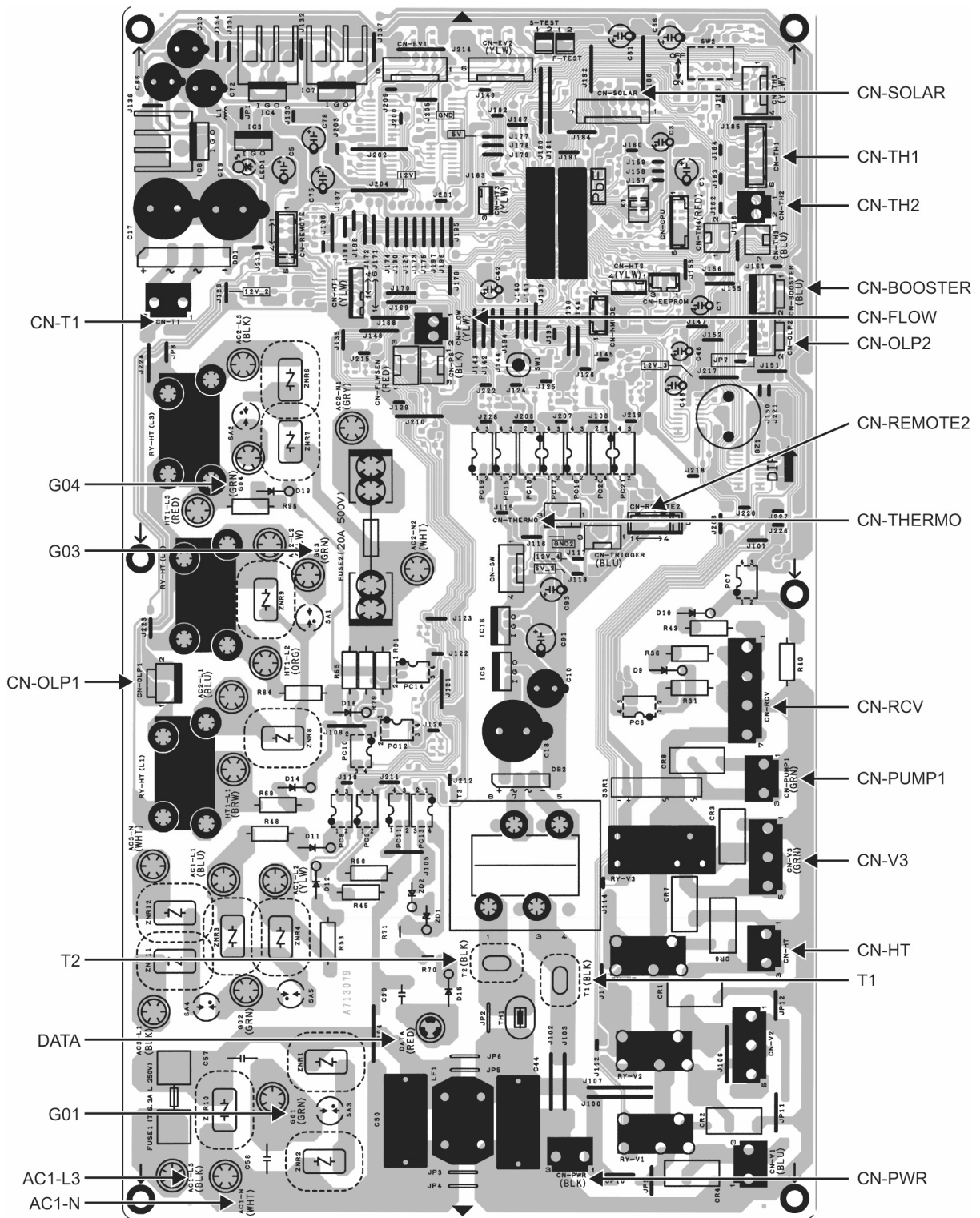

10.1.2 Solar Printed Circuit Board (Optional)

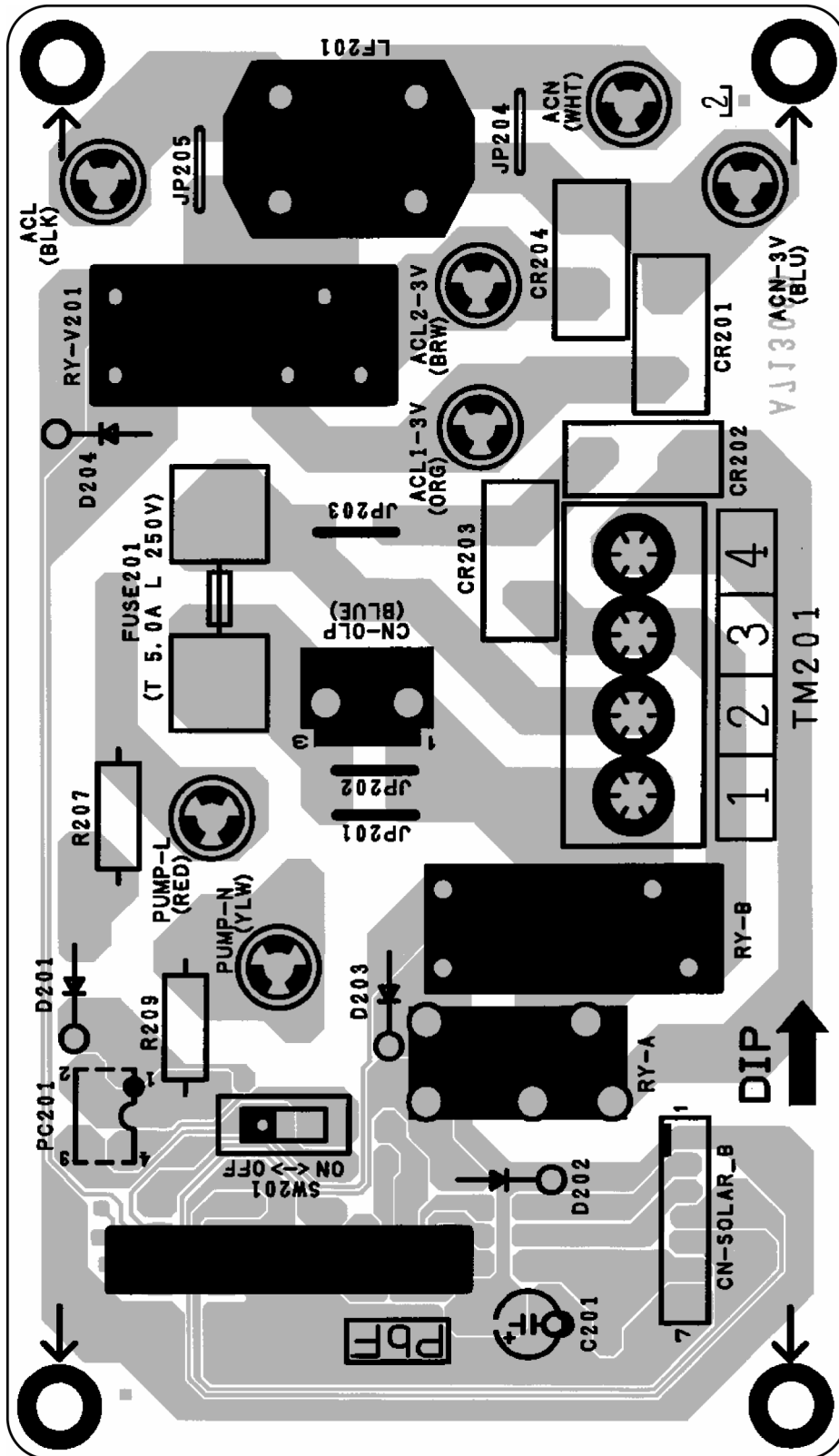

10.2.2 Capacitor Printed Circuit Board

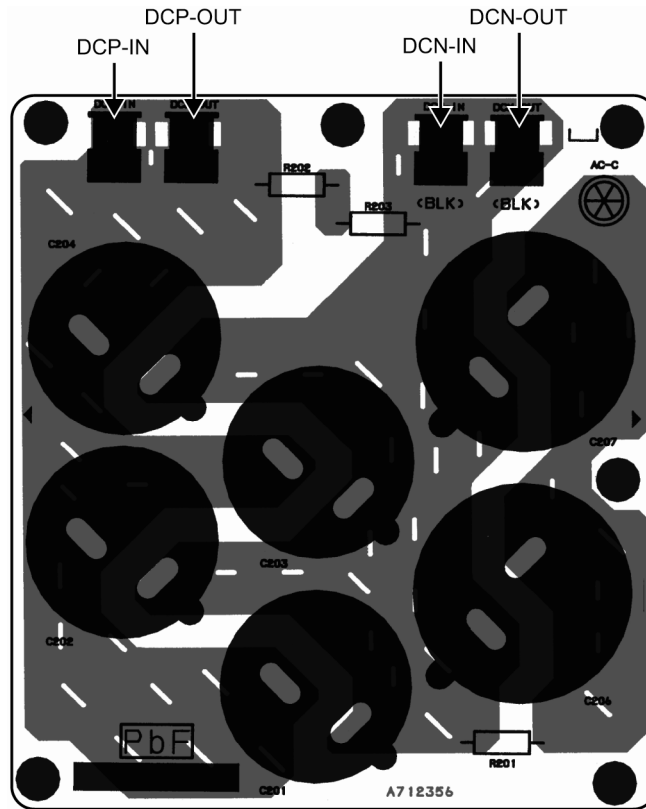

10.2.3 Noise Filter Printed Circuit Board

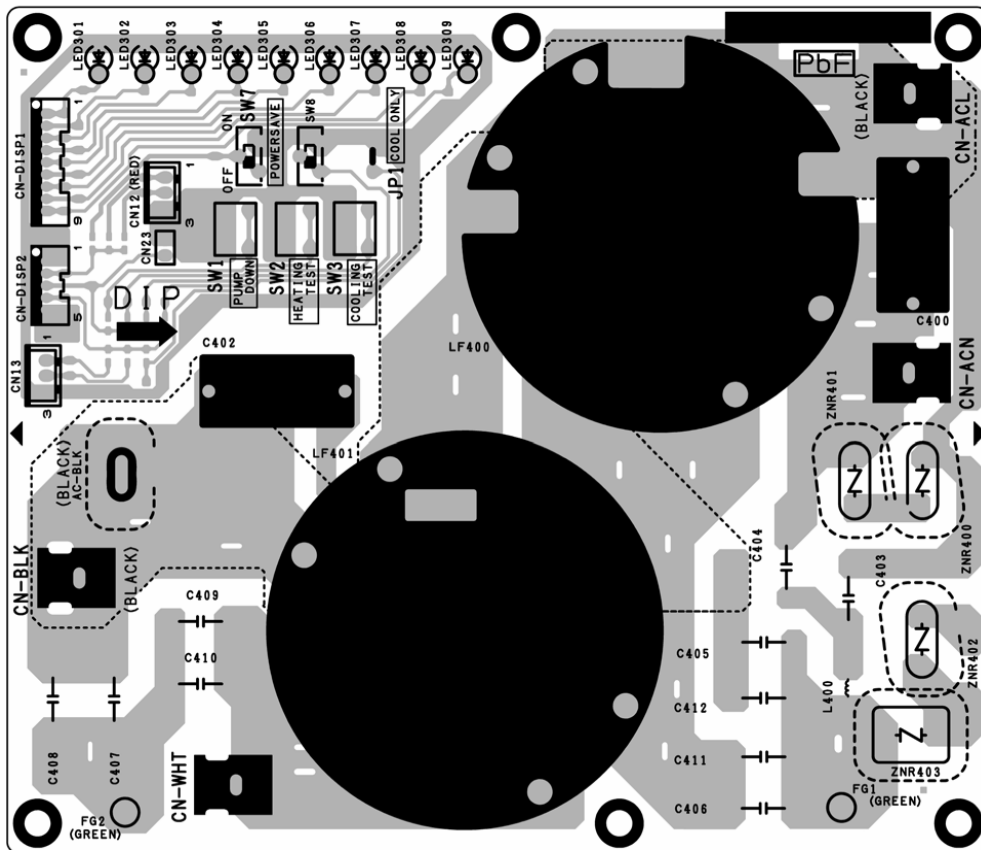

11. Installation Instruction

Mono Bloc Unit

Dimension Diagram

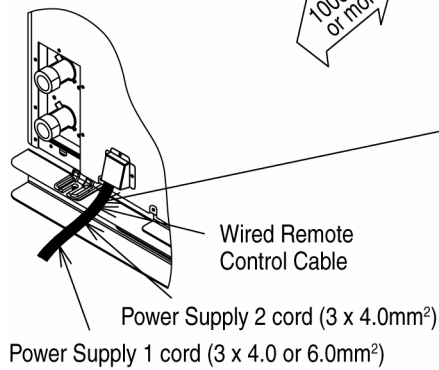
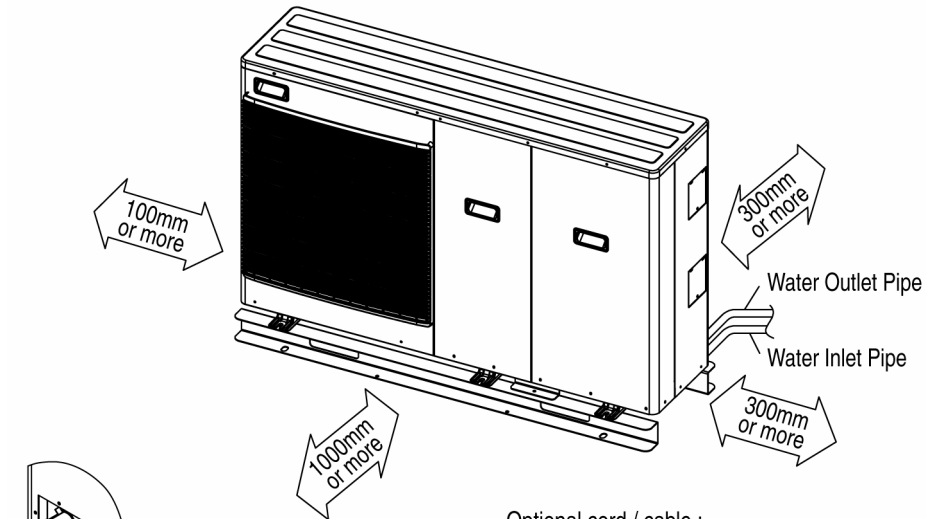
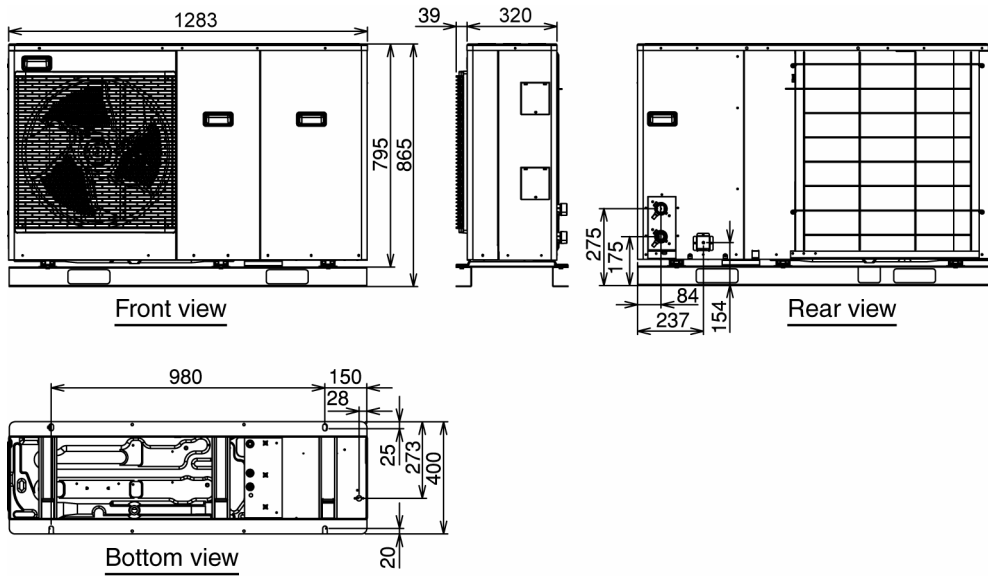

Optional cord / cable :-

- 2-way valve cable (3 x min 0.5mm²)
- *Cooling model only
- 3-way Valve cable (3 x min 0.5mm²)
- Booster Heater cord (3 x min 1.5mm²)
- Room Thermostat cable (4 or 3 x min 0.5mm²)
- Tank OLP cable (2 x min 0.5mm²)
- Tank Sensor cable (2 x min 0.3mm²)
- External Controller cable (2 x min 0.5mm²)
- Solar Three-way Valve cable (3 x min 0.5mm²)
- Solar Pump Station cable (2 x min 0.5mm²)

Type designation 60245 IEC 57 or heavier cord/ cable

Main Components

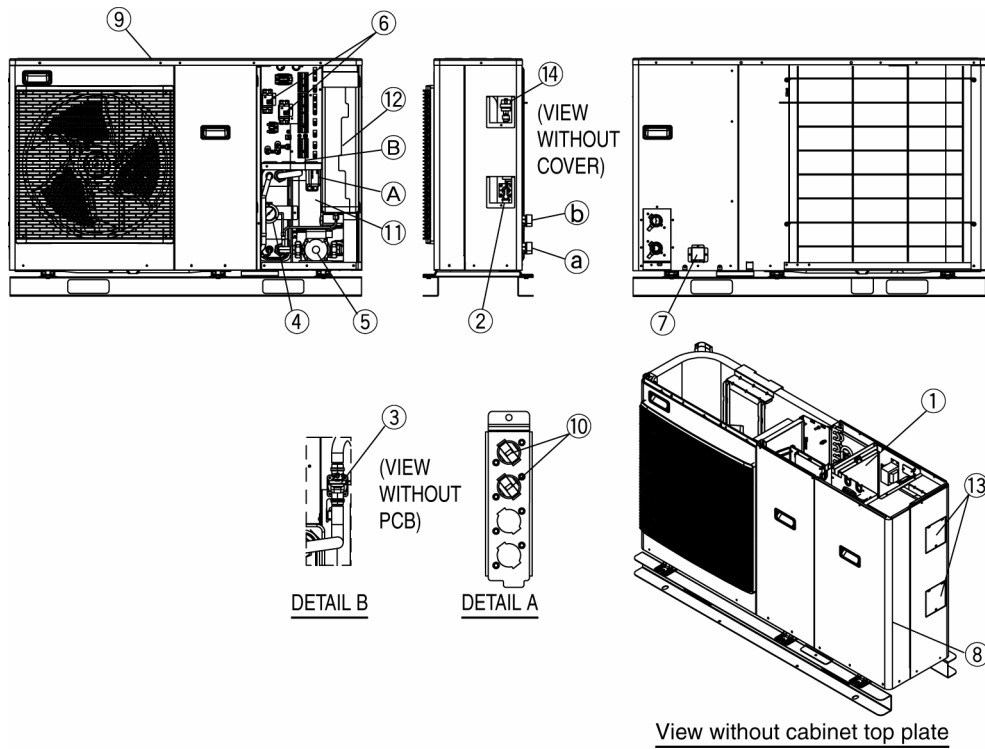

Component name

- | | |
|-------------------------|-----------------------|
| ① PCB | ⑧ Cabinet front plate |
| ② Pressure relief valve | ⑨ Cabinet top plate |
| ③ Flow switch | ⑩ Overload protector |
| ④ Pressure gauge | ⑪ Heater assembly |
| ⑤ Water pump | ⑫ Expansion vessel |
| ⑥ RCCB | ⑬ Cover |
| ⑦ Cable cover | ⑭ Air purge valve |

Connector name

- | |
|----------------|
| Ⓐ Water inlet |
| Ⓑ Water outlet |

It is advisable to avoid more than 2 blockage directions. For better ventilation & multiple-outdoor installation, please consult authorized dealer/specialist.

11.1 Select the Best Location

- Install the Mono bloc unit in outdoor locations only.
- Avoid installations in areas where the ambient temperature may drop below -20°C .
- The Mono bloc unit must be installed on a flat, solid surface.
- A place removed from any heat source or steam which may effect the operation of the mono bloc unit.
- A place where air circulation is good.
- A place where drainage can be easily done.
- A place where Mono bloc unit's operation noise will not cause discomfort to the user.
- A place which is accessible for maintenance.
- Ensure to keep minimum distance of spaces as illustrated below from wall, ceiling, or other obstacles.
- A place where flammable gas leaking might not occur.
- A place where the Mono bloc unit's piping and wiring lengths come within reasonable ranges.
- If an awning is built over the unit to prevent direct sunlight or rain, be careful that heat radiation from the condenser is not obstructed.
- Do not place any obstacles which may cause a short circuit of the discharged air.
- Avoid installing the Mono bloc unit at a location where suction side may be exposed directly to wind.
- If Mono bloc unit installed near sea, region with high content of sulphur or oily location (e.g. machinery oil, etc.), its lifespan may be shorten.
- When installing the product in a place where it will be affected by typhoon or strong wind such as wind blowing between buildings, including the rooftop of a building and a place where there is no building in surroundings, fix the product with an overturn prevention wire, etc. (Overturn prevention fitting model number: K-KYZP15C)
- When connecting solar pump station cable between Mono bloc unit and solar pump station, the distance between both apparatuses shall be 2 ~ 8 meters and the length of the said cable must be shorter than 10 meter.
Failure to do so may lead to abnormal operation to the system.



11.2 Mono Bloc Unit Installation

Mono bloc unit will become heavy when filled with water. Please install the unit on a strong concrete floor and consider the weight of the unit and water.

- Fix Mono bloc unit on the concrete floor with M12 anchor bolt at 4 locations.
- Pull-out strength of these anchor bolts must be above 15000N.

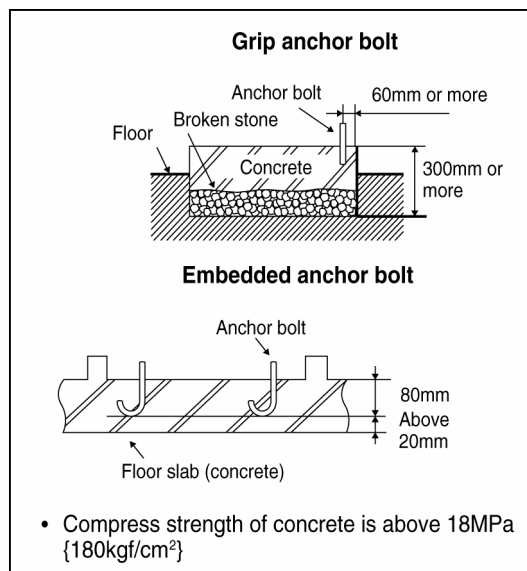

Illustration of grip type and embedded type anchor bolt

11.3 Piping Installation

⚠ WARNING

This section is for authorized and licensed electrician / water system installer only. Work behind the front plate secured by screws must only be carried out under supervision of qualified contractor, installation engineer or service person.

Please engage a licensed water circuit installer to install this water circuit.

- The minimum requirement of water in the system is 30 litres. If this value could not be achieved, please install additional buffer tank (field supply).
- This water circuit must comply with relevant European and national regulations (including EN61770), and local building regulation codes.
- Ensure the components installed in the water circuit could withstand water pressure during operation.
- Do not apply excessive force to piping that may damage the pipes.
- Use Rp 1 ¼" nut for both water inlet and water outlet connection and clean all piping with tap water before connecting to the Mono bloc unit.
- Cover the pipe end to prevent dirt and dust when inserting it through a wall.
- If an existing tank is to be connected to this Mono bloc unit, ensure the pipes are clean before water pipe installation is carried out.
- An external filter (30 mesh or more field supplied) must be installed before the water inlet of the Mono bloc unit.
- Refer to Diagram 3.1 for pipe connection of Radiator, Floor Heater, Tank Unit, Solar Pump Station, 3-way Valve Kit and etc. Fail to connect the pipes appropriately might cause the unit malfunction.

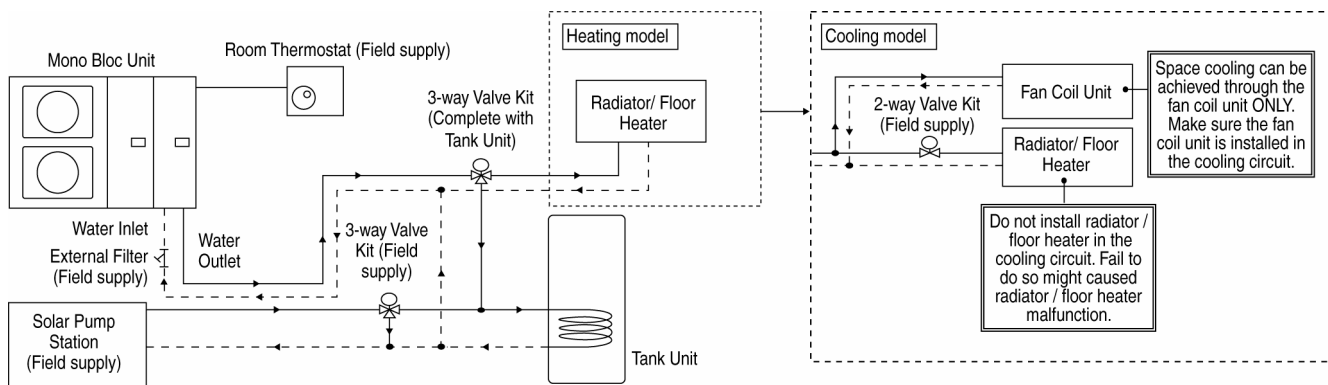
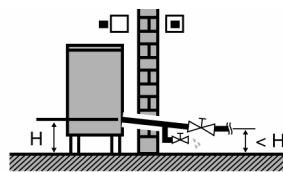

Diagram 3.1: Typical Water Piping Installation

- Choose proper sealer which can withstand the pressures and temperatures of the system.
- Make sure to use two spanners to tighten the connection. Tighten the nuts with torque wrench: 117.6 N•m.
- If non-brass metallic piping is used for installation, make sure to insulate the piping to prevent galvanic corrosion.
- Do not use pipes that are crushed or deformed. If these inferior pipes are used, it may cause unit malfunction.
- Make sure to insulate the water circuit piping (insulator thickness : 20mm or more) to prevent condensation during cooling operation (cooling model only) and reduction of heating capacity, as well as avoid freezing of the outdoor water circuit piping during winter season.
- After installation, check the water leakage condition in connection area during test run.
- After test run, please clean the external filter. Reinstall it after finish cleaning.
- In case of a power supply failure or pump operating failure, drain the system (as suggested in the figure below).



When water is idle inside the system, freezing up is very likely to happen which could damage the system.

Drainage piping installation

- Use a drain hose with inner diameter of 15 mm.
- The hose must be installed in a continuously downward direction and left open to the frost-free atmosphere.
- If drain hose is long, use a metal support fixture along the way to eliminate the wavy pattern of drain tube.
- Water will drip from this hose, therefore the outlet of this hose must be installed in an area where the outlet cannot become blocked.
- Do not insert this hose into Sewage or drain pipe that may generate ammonia gas, sulfuric gas, etc.
- If necessary, use a hose clamp to tighten the hose at drain hose connector to prevent it from leaking.

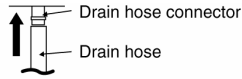
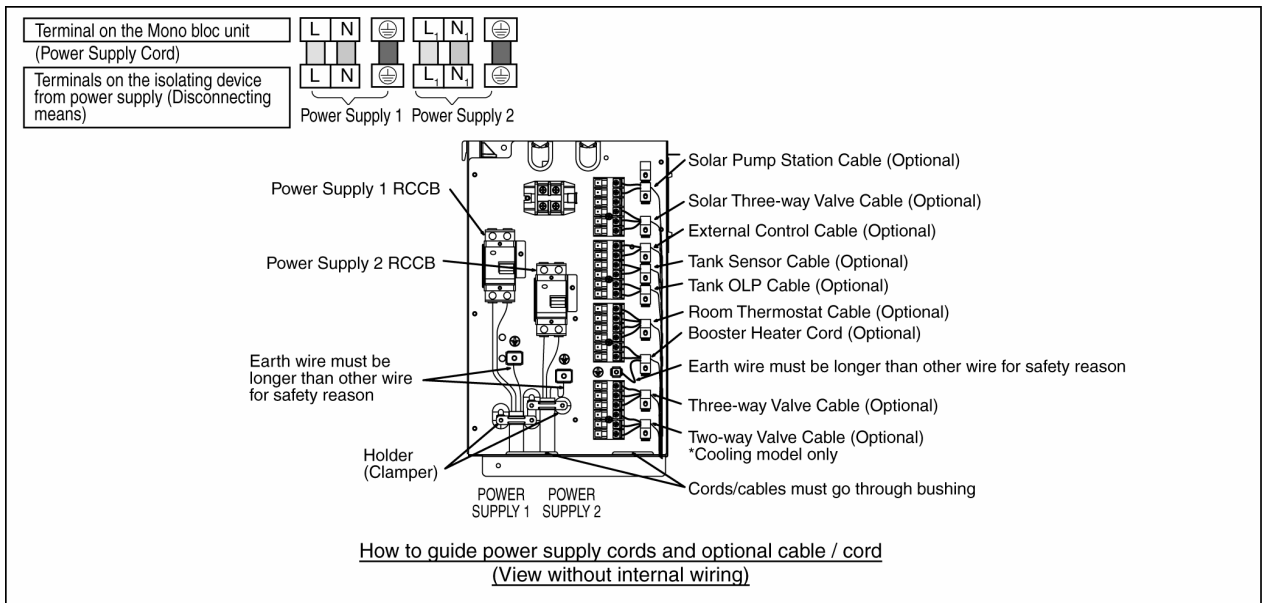

Illustration of how to fix drain hose to Mono bloc unit

11.4 Connect The Cord And Cable To Mono Bloc Unit

(REFER TO WIRING DIAGRAM AT UNIT FOR DETAIL)

- 1 An isolating device must be connected to the power supply cable.
 - Isolating device (Disconnecting means) should have minimum 3.0 mm contact gap.
 - Connect the approved polychloroprene sheathed power supply 1 cord (3 x 4.0 or 6.0 mm²) and power supply 2 cord (3 x 4.0 mm²), type designation 60245 IEC 57 or heavier cord to the RCCB, and to the other end of the cord to isolating device (Disconnecting means).
- 2 To avoid the cable and cord being damaged by sharp edges, the cable and cord must be passed through cable cover ⑦ (located at the rear side of the mono bloc unit) before being connected to the terminal block. The cable cover ⑦ must be screw properly and must not be removed.
- 3 Secure the cable onto the control board with the holder (clammer).



*REMARK: Cooling model refer to WH-M*C*** models.

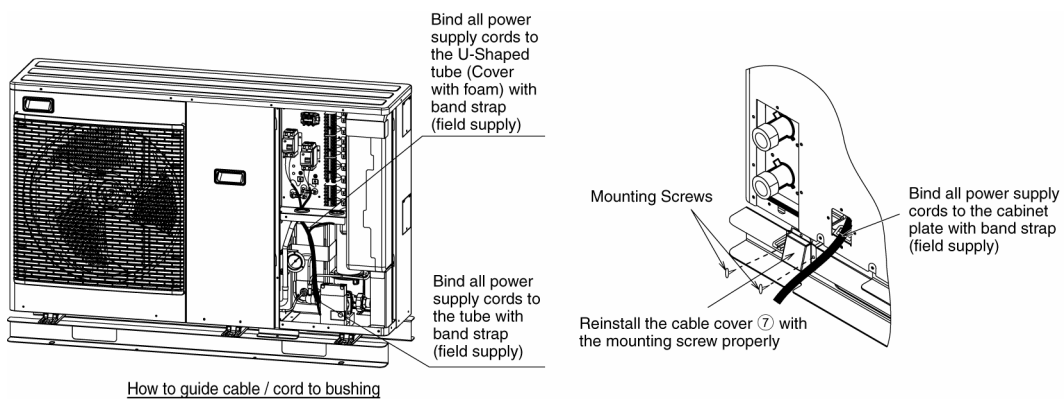

Connecting with external device (optional)

- 1 All connections shall follow to the local national wiring standard.
- 2 It is strongly recommended to use manufacturer-recommended parts and accessories for installation.
- 3 Maximum output power of booster heater shall be ≤ 3 kW. Booster Heater cord must be (3 x min 1.5 mm²), of type designation 60245 IEC 57 or heavier.
- 4 Two-way Valve shall be spring and electronic type, refer to "Field Supply Accessories" table for details. Valve cable shall be (3 x min 0.5 mm²), of type designation 60245 IEC 57 or heavier, or similarly double insulation sheathed cable.

* note: - Shall be CE marking compliance component.
- Maximum load for the valve is 9.8VA.

*Cooling model only

- 5 Three-way Valve shall be spring and electronic type, refer to "Field Supply Accessories" table for details. Valve cable shall be (3 x min 0.5 mm²), of type designation 60245 IEC 57 or heavier, or similarly double insulation sheathed cable.
 - * note: - Shall be CE marking compliance component.
 - It shall be directed to heating mode when it is OFF.
 - Maximum load for the valve is 9.8VA.
- 6 Room Thermostat cable shall be connected to "Room Thermostat", refer to "Field Supply Accessories" table for details. Room Thermostat cable must be (4 or 3 x min 0.5 mm²), double insulation layer of PVC-sheathed or polychloroprene sheathed cable.
- 7 Tank OLP cable must be (2 x min 0.5 mm²), double insulation layer of PVC-sheathed or polychloroprene sheathed cable.
 - * note: if such connection deemed NO necessary for tank OLP, please connect jumper between terminal no. 13 and 14.
- 8 Tank Sensor shall be resistance type, please refer to Graph 4.1 for the characteristic and details of sensor. Its cable shall be (2 x min 0.3 mm²), double insulation layer (with insulation strength of min 30V) of PVC-sheathed or polychloroprene sheathed cable.
- 9 External Controller shall be connected to 1-pole switch with min 3.0mm contact gap. (connection refer to Diagram 4.2). Its cable must be (2 x min 0.5 mm²), double insulation layer of PVC-sheathed or polychloroprene sheathed cable.
 - * note: - When making such connection, kindly remove the jumper between terminal no. 17 and 18.
 - Switch used shall be CE compliance component.
 - Maximum operating current shall be less than 3A_{rms}.
- 10 Must install Solar Connection PCB (optional) to Mono bloc unit when Solar Pump Station is utilized. Refer Solar Connection PCB installation instruction for detail of installation.
- 11 Solar Three-way Valve cable shall be (3 x min 0.5 mm²), double insulation layer PVC-sheathed or polychloroprene sheathed cable.
- 12 Solar Pump Station cable shall be (2 x min 0.5 mm²), of double insulation PVC-sheathed or polychloroprene sheathed cable. Strongly recommended install with maximum length of 10 meter only.

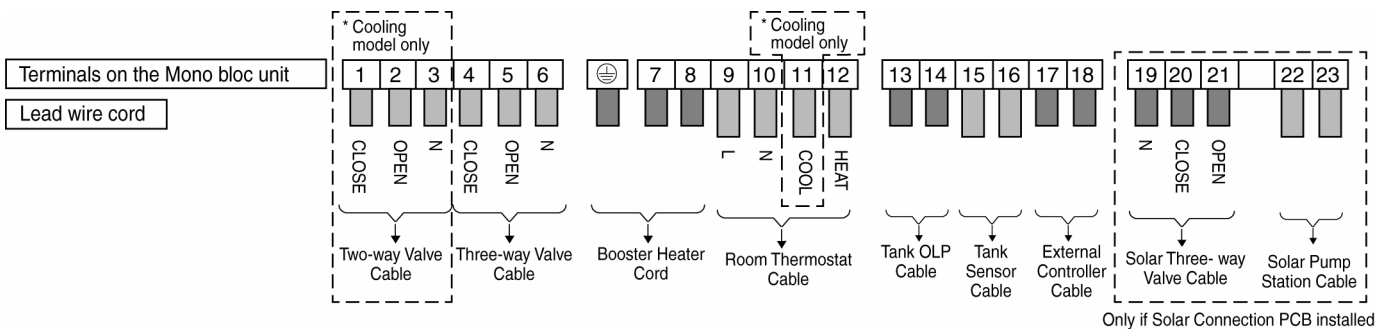

Terminal screw	Tightening torque N•cm {kgf•cm}
M4	157~196 {16~20}
M5	196~245 {20~25}

11.4.1 Wire Stripping And Connecting Requirement

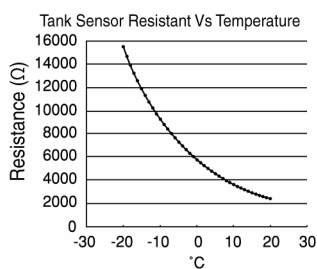
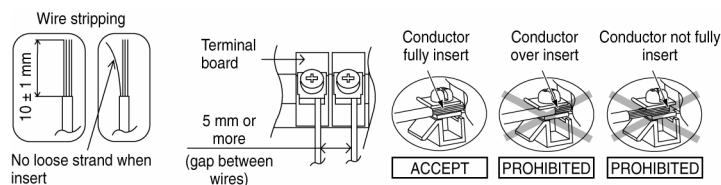

Graph 4.1: Tank sensor characteristic

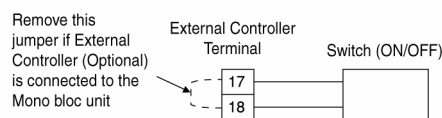











Diagram 4.2: External Controller connecting diagram





11.4.2 Connecting Requirement

- The equipment's power supply 1 complies with IEC/EN 61000-3-12 provided that the short-circuit power S_{sc} is greater than or equal to 868.69kW at the interface point between the user's supply and the public system. It is the responsibility of the installer or user of the equipment to ensure, by consultation with the distribution network operator if necessary, that the equipment is connected only to a supply with a short-circuit power S_{sc} greater than or equal to 868.69kW.
- The equipment's power supply 1 shall be connected to a suitable supply network, having service current capacity $\geq 100A$ per phase. Please liaise with supply authority to ensure that the service current capacity at the interface point is sufficient for the installation of the equipment.
- The equipment's power supply 2 complies with IEC/EN 61000-3-12.
- The equipment's power supply 2 shall be connected to a suitable supply network, with the following maximum permissible system impedance Z_{max} at the interface for models: 0.236Ω
Please liaise with supply authority to ensure that the power supply 2 is connected only to a supply of that impedance or less.

11.4.3 Wired Remote Control Instalation

 WARNING	
	Do not modify the length of the remote control cable. Otherwise, it will cause fire or electrical shock.
	Be sure to turn off the main power before installing and connecting the remote control. Otherwise, it will cause the electrical shock.
	Use the attached accessories parts and specified parts for installation. Otherwise, it will cause the set to fall, fire or electrical shock.
	If passing the remote control cable through a wall, be sure to install a water trap above the cable. Otherwise, it will cause the electrical shock.
 CAUTION	
	Install in a flat surface to avoid warping of remote control, else damage to the LCD case or operation problems may result.
	Avoid installing the remote control cable near refrigerant pipes or water pipes, else will cause electrical shock or fire.
	Install the remote control cable at least 5cm away from electric wires of other appliances to avoid miss operation (electromagnetic noise).
	Be sure to use only the accessory screws to avoid damage of remote control PCB.

Attached Accessories

No.	Name	Qty.	Diagram	Remark
(1)	Remote control	1		
(2)	Remote control cable	1		Length (15 m)
(3)	Screw (M4 machine pitched – 30mm)	3		Installing the remote control to an outlet box (embedded cable)
(4)	Screw (M4 self tapping – 14mm)	3		Installing the remote control to the wall (exposed cable)

11.4.3.1 Selecting The Installation Location

- Allow sufficient space around the remote control (1) as shown in the illustration above.
- Install in a place which is away from direct sunlight and high humidity.
- Install in a flat surface to avoid warping of the remote control. If installed to a wall with an uneven surface, damage to the LCD case or operation problems may result.
- Install in a place where the LCD can be easily seen for operation. (Standard height from the floor is 1.2 to 1.5 meters.)
- Avoid installing the remote control cable near refrigerant pipes or drain pipes, else it will cause electrical shock or fire.

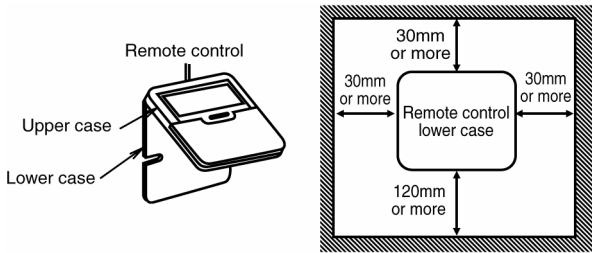

11.4.3.2 Installing The Remote Control Unit To The Wall

- 1 Remove the remote control (1) lower case. (Insert a flat-tipped screw driver or similar tool 2 to 3 mm into one of the gaps at the bottom of the case, and twist to open. Refer to the illustration at right.) Be careful not to damage the lower case.
- 2 Do not remove the protective tape which is affixed to the upper case circuit board when removing the remote control lower case.
- 3 Secure the lower case to an outlet box or wall. Refer to (A) or (B) instructions below depending on your choice of cable installation.
- 4 Be sure to use only the screws provided.
- 5 Do not over tighten the screws, as it may result in damage to the lower case.

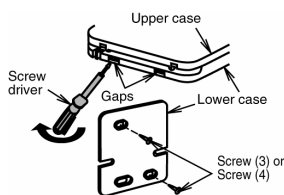

A. If Remote Control Cable Is Embedded

- 1 Embed an outlet box (JIS C 8336) into the wall. Outlet box may be purchased separately. Medium-sized square outlet box (obtain locally) Part No. DS3744 (Panasonic Co., Ltd.) or equivalent.
- 2 Secure the remote control lower case to the outlet box with the two accessory screws (3). Make sure that the lower case is flat against the wall at this time, with no bending.
- 3 Pass the remote control cable (2) into the box.
- 4 Route the remote control cable (2) inside the lower case through rear feeding-out direction.

- 5 Insert firmly the connector of remote control cable (2) to connector (CON1) in the upper case circuit board. [Refer to the illustration at below.]
- 6 Secure the remote control upper case to the lower case with the tabs provided.

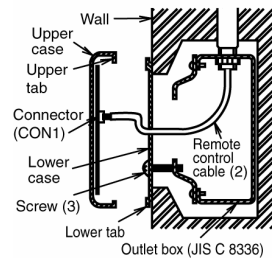

CAUTION
When the wall is hollow, please be sure to use the sleeve for remote control cable to prevent dangers caused by mice biting the cable.

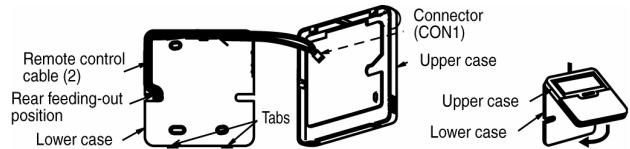

B. If Remote Control Cable Is Exposed

- 1 Install the remote control lower case to the wall with the two accessory screws (4).
- 2 Fasten the screws properly until screw head is lower than the rib and reach the base of remote control lower case to ensure they do not damage the PCB inside the remote control (1).

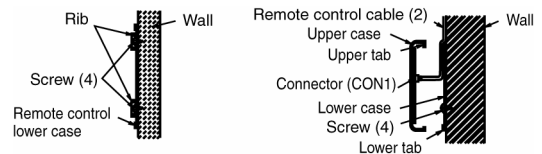

- 3 The feeding-out direction for the remote control cable can be either via top, left or right side.
- 4 Use nipper to cut a notch at the upper case. (Select the intended feeding-out position)
- 5 Route the remote control cable (2) inside the lower case in accordance with the intended feeding-out direction. (Refer to the illustration at below)
- 6 Insert firmly the connector of remote control cable (2) to connector (CON1) in the upper case circuit board. (Refer to the illustration at below)
- 7 Secure the remote control upper case to the lower case with the tabs provided.

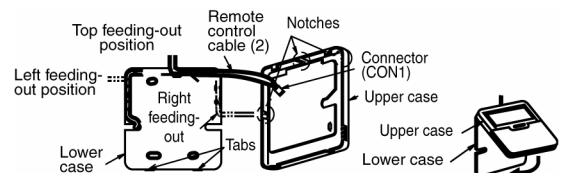

11.4.3.3 Connecting The Remote Control Cable To Mono Bloc Unit

⚠ CAUTION
Be sure to turn off the main power before installing and connecting the remote control. Otherwise, it will cause the electrical shock.

- 1 Remove the cabinet front plate.
- 2 Connect the remote control cable with the provided connector as shown in below illustration. (Refer wiring diagram for detail.)
- 3 Guide the remote control cable through the clamber, bushing and Cable cover ⑦. (Refer illustration “How to connect Remote Control to Provided Connector” for detail.)
- 4 Reinstall the cabinet front plate after connection complete.

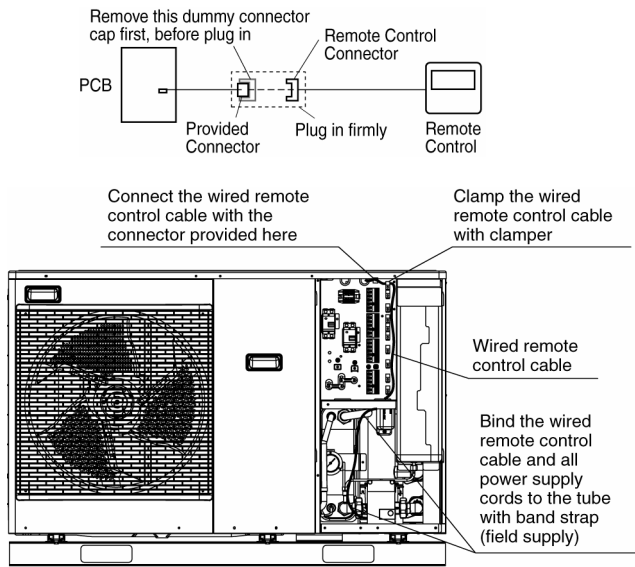

How to connect Remote Control to Provided Connector

11.4.3.4 Disposal of Mono Bloc Unit Drain Water

- When a Drain elbow ① is used, please ensure to follow below:
 - The unit should be placed on a stand which is taller than 50mm.
 - Cover the 8 holes (ø20mm) with Rubber cap ② (refer to illustration below)
 - Use a tray (field supply) when necessary to dispose the Mono bloc unit drain water.

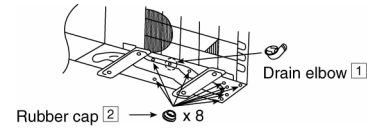

- If the unit is used in an area where temperature falls below 0°C for 2 or 3 consecutive days, it is recommended not to use the Drain elbow ① and Rubber cap ②, for the drain water freezes and the fan will not rotate.

12. Operation and Control

12.1 Basic Function

Inverter control, which equipped with a microcomputer in determining the most suitable operating mode as time passes, automatically adjusts output power for maximum comfort always. In order to achieve the suitable operating mode, the microcomputer maintains the set temperature by measuring the temperature of the environment and performing temperature shifting. The compressor at mono bloc unit is operating following the frequency instructed by the microcomputer at indoor unit that judging the condition according to internal water setting temperature and water outlet temperature.

12.1.1 Internal Water Setting Temperature

Once the operation starts, remote control setting temperature will be taken as base value for temperature shifting processes. These shifting processes are depending on the Air-to-Water Heatpump settings and the operation environment. The final shifted value will be used as internal water setting temperature and it is updated continuously whenever the electrical power is supplied to the unit.

12.1.2 Heating Operation

12.1.2.1 Thermostat control

- Compressor is OFF when Water Outlet Temperature - Internal Water Setting Temperature $> 2^{\circ}\text{C}$ for continuously 3 minutes.
- Compressor is ON after waiting for 3 minutes, if the Water Outlet Temperature - Water Inlet Temperature (temperature at thermostat OFF is triggered) $< -3^{\circ}\text{C}$.

12.1.3 Tank Mode Operation

Control contents:

- 3 ways valve direction
 - 3 ways valve switch and fix to tank side.
- Heat pump Thermostat characteristic
 - Water set temperature = Tank set temperature or **51°C** whichever lower.
 - Heat pump Water Outlet set temperature is set to Maximum (53°C) at tank mode
- i. Case 1
 - THERMO OFF TEMP:
 - 1 THERMO OFF TEMP = Water set temperature + **0°C** .
 - 2 Tank temperature $>$ THERMO OFF TEMP for continuous 10 seconds after heat pump OFF, water pump OFF.
 - THERMO ON TEMP:
 - 1 THERMO ON TEMP = Water set temperature + **-2°C** .
When detect tank temperature $<$ THERMO ON TEMP, water pump ON for 3 minutes then heat pump ON.
- ii. Case 2
 - Heat pump THERMO OFF TEMP:
 - 1 Heat pump THERMO OFF TEMP = 55°C + **2°C** .
 - 2 Water outlet temperature $>$ Heat pump THERMO OFF TEMP for continuous 3 minutes, heat pump OFF.
 - Heat pump THERMO ON TEMP:
 - 1 Heat pump THERMO ON TEMP = Water inlet during thermo off time + **-3°C** .
 - 2 Heat pump ON back when water outlet temperature $<$ Heat pump THERMO ON TEMP.
- iii. Case 3
 - Heat pump THERMO OFF TEMP:
 - 1 Water inlet temperature $>$ 55°C for continuous 60 secs, heat pump OFF.
 - Heat pump THERMO ON TEMP:
 - 1 Heat pump THERMO ON TEMP = Water inlet temperature $<$ 55°C .

- Booster heater control
 - Booster heater turn On and Off follow normal operation.
 - Booster heater turn ON condition:
 - 1 During startup time (initialization), Booster heater turn ON after DELAY TIMER.
 - 2 When tank temperature lower than HEATER ON TEMP
 - 3 20 minutes from previous heater off.
 - Booster heater turn OFF condition:
 - 1 When tank temperature higher than tank set temperature for continuous 15 secs.
- Solar 3 way valve
 - Solar pump operates follow solar operation specification.
- 2 way valve closes
- Others
 - Indoor backup heater cannot be ON during tank mode only.

Tank mode

Tank set Temp. = 65°C

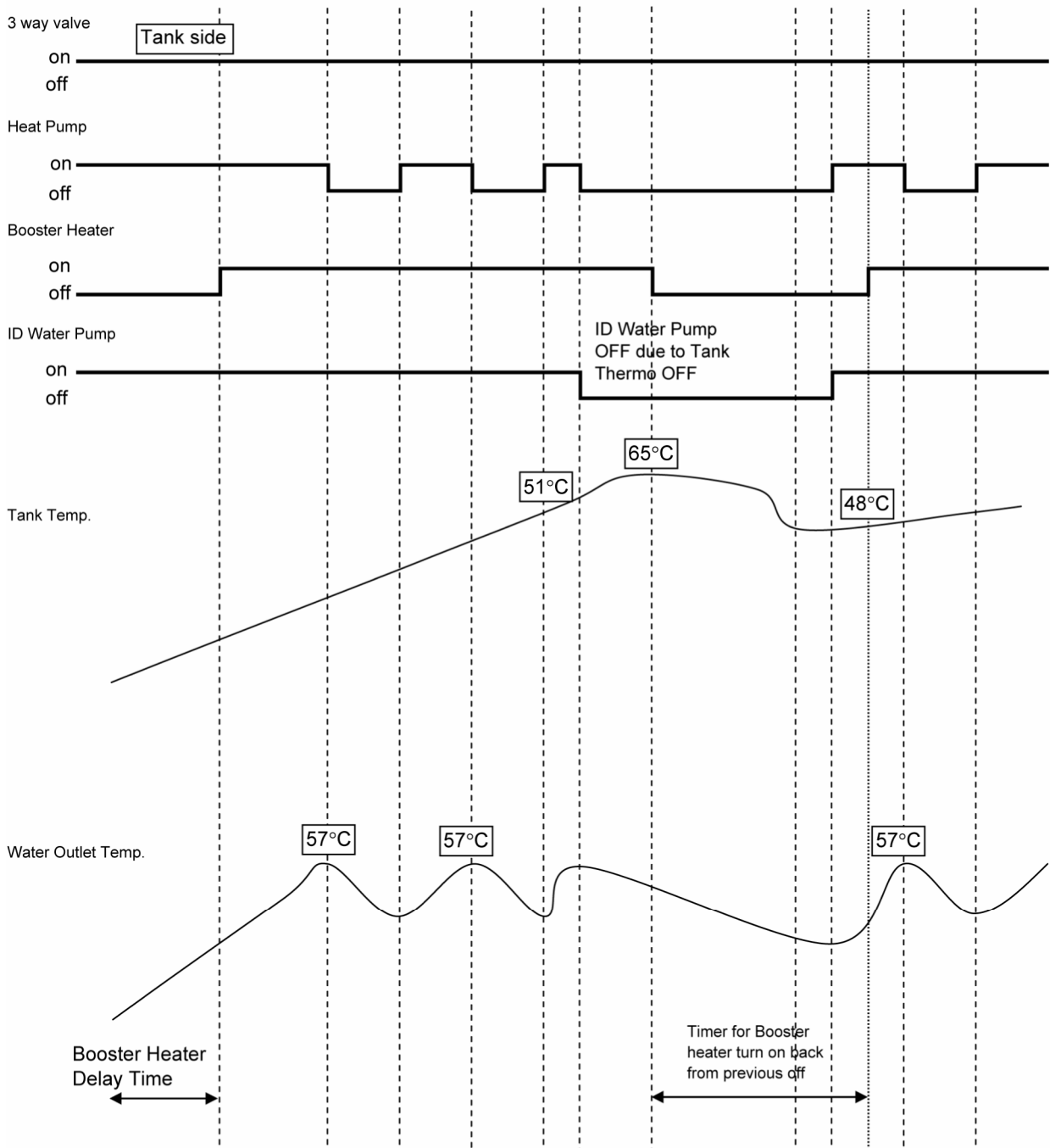

Tank mode (Solar Priority is set)

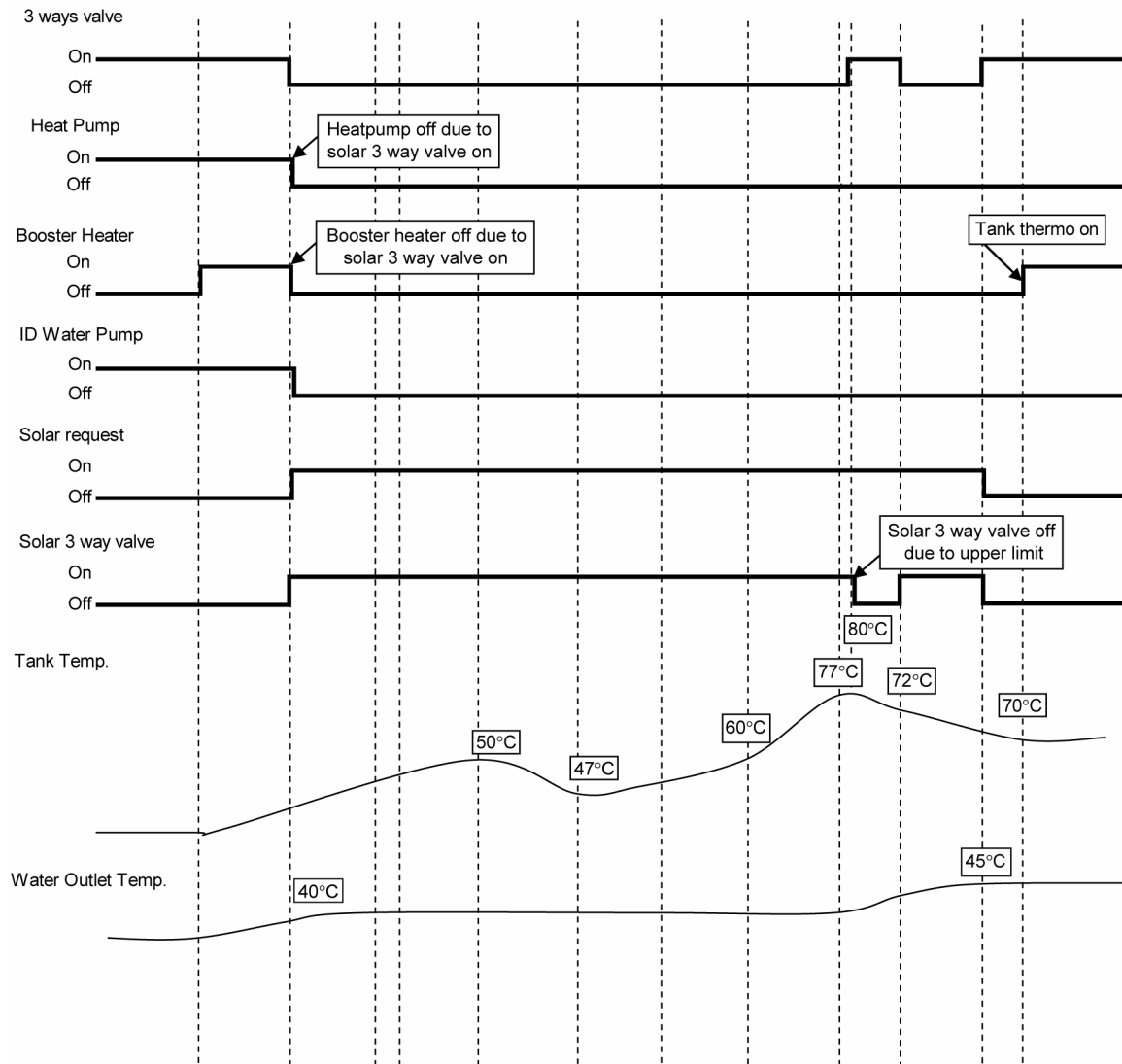

Tank mode (Solar Priority is not set)

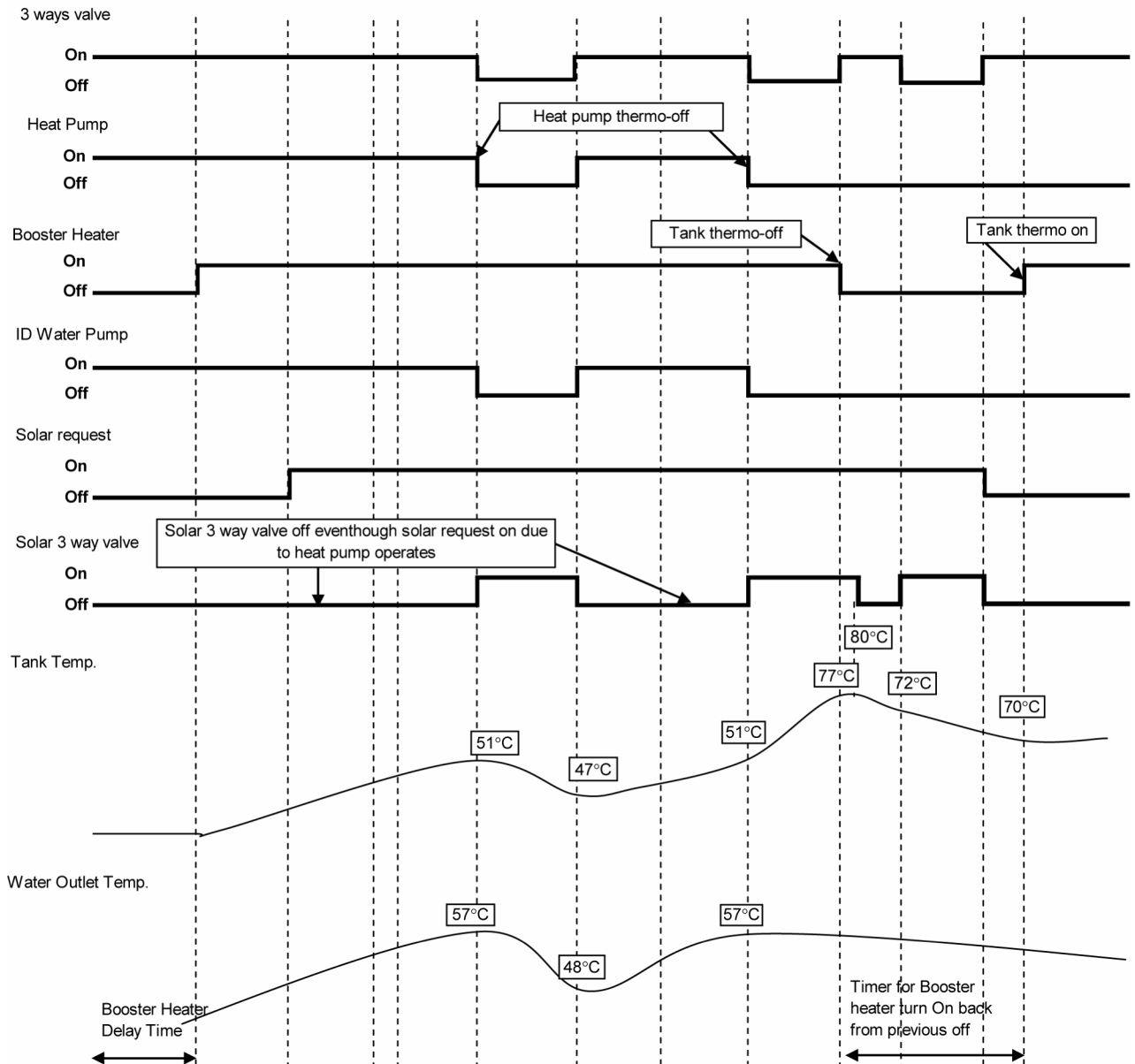

12.1.4 Heat + Tank Mode Operation

Setting 1: When Heating priority is set by remote control:

- 1 3 ways valve control:
 - 3 ways valve switch to room side during External Room Thermo ON **OR** Solar 3 ways valve ON **OR** Tank Thermo OFF time, and switch to tank side at External Room Thermo OFF **AND** Solar 3 ways valve OFF
- 2 Heat pump operation control:-
 - **During External Room Thermo ON time:** (When room thermo ON, heat pump must operate to room side)
 - Heat pump operate follow normal operation at room side
 - **During External Room Thermo OFF time:**
 - Switch 3 ways valve to tank side, IF
 - Under Solar Priority Set condition:
 - Tank temperature < Tank THERMO ON TEMP **AND** Solar Valve OFF
 - Under Solar Priority Not Set condition:
 - Tank temperature < Tank THERMO ON TEMP

- Switch back 3 ways valve to room side, Heat pump and water pump turn OFF, IF
 - External Room Thermo ON back **OR**
 - Under Solar Priority Set condition:
 - Tank temperature > Tank THERMO OFF TEMP. for continuous 3 minutes **OR** Solar Valve ON
 - Under Solar Priority Not Set condition:
 - Tank temperature > Tank THERMO OFF TEMP for continuous 3 minutes

* THERMO ON and THERMO OFF point refer to case below.

Operation condition when 3 ways valve switch to tank side:

- Tank water set temperature = tank set temperature or [51°C] whichever lower
- Heat Pump Water Outlet set temperature is set to [55°C] during tank interval
- Initial Tank THERMO ON TEMP = heat pump tank target temperature + [55°C]

Case 1:

- THERMO OFF TEMP:
 1. THERMO OFF TEMP = Tank water set temperature + [0°C].
 2. Tank temperature > THERMO OFF TEMP for continuous 10 seconds after compressor off, switch 3 ways valve to room side.
- Next THERMO ON TEMP:
 1. THERMO ON TEMP = Heat pump tank target temperature + [-2°C] or
 2. If tank temperature < THERMO ON TEMP **AND** External Room Thermo OFF, switch to tank side.

Case 2:

- Heat pump THERMO OFF TEMP:
 1. Heat pump THERMO OFF TEMP = 55°C + [+2°C].
 2. Water outlet temperature > Heat pump THERMO OFF TEMP for continuous 3 minutes, heat pump OFF.
- Next THERMO ON TEMP:
 1. THERMO ON TEMP = Water inlet when heat pump THERMO OFF + [-3°C].
 2. If water outlet temperature < THERMO ON TEMP **AND** External Room Thermo OFF, heat pump ON.

Case 3:

- Heat pump THERMO OFF TEMP:
 1. Water inlet temperature > 55°C for continuous 60 secs, heat pump OFF.
- Next THERMO ON TEMP:
 1. THERMO ON TEMP = Water inlet temperature < 55°C.
 2. If water inlet temperature < THERMO ON TEMP **AND** External Room Thermo OFF, heat pump ON.

Case 4: (Only during solar priority is set condition)

- When solar request ON, solar valve will ON and switch 3 ways valve to room side
- THERMO ON TEMP:
 1. THERMO ON TEMP = Heat pump tank target temperature + [-2°C].
 2. If tank temperature < THERMO ON TEMP **AND** External Room Thermo OFF **AND** Solar 3WV OFF, switch to tank side.

3 Backup Heater control:-

- During External Room Thermo ON time, follow normal backup heater control operation
- During External Room Thermo OFF time, Backup heater OFF

4 Booster heater control:

- Booster heater On/Off follow normal operation.

* Under solar priority is set condition, when solar 3 way valve is ON, booster heater turn OFF.

5 Solar 3 way valve:

- o Solar 3 way valve operates follow solar operation specification.

* Under solar priority is set condition, when solar 3WV turn ON, booster heater will turn OFF and 3 ways valve switch to room side.

* Under solar priority is not set condition, solar 3WV will OFF when heat pump operate to tank side.

- o 2 way valve opens.

Heat + Tank Mode (Heating priority set)

Under Solar Priority Set Condition:

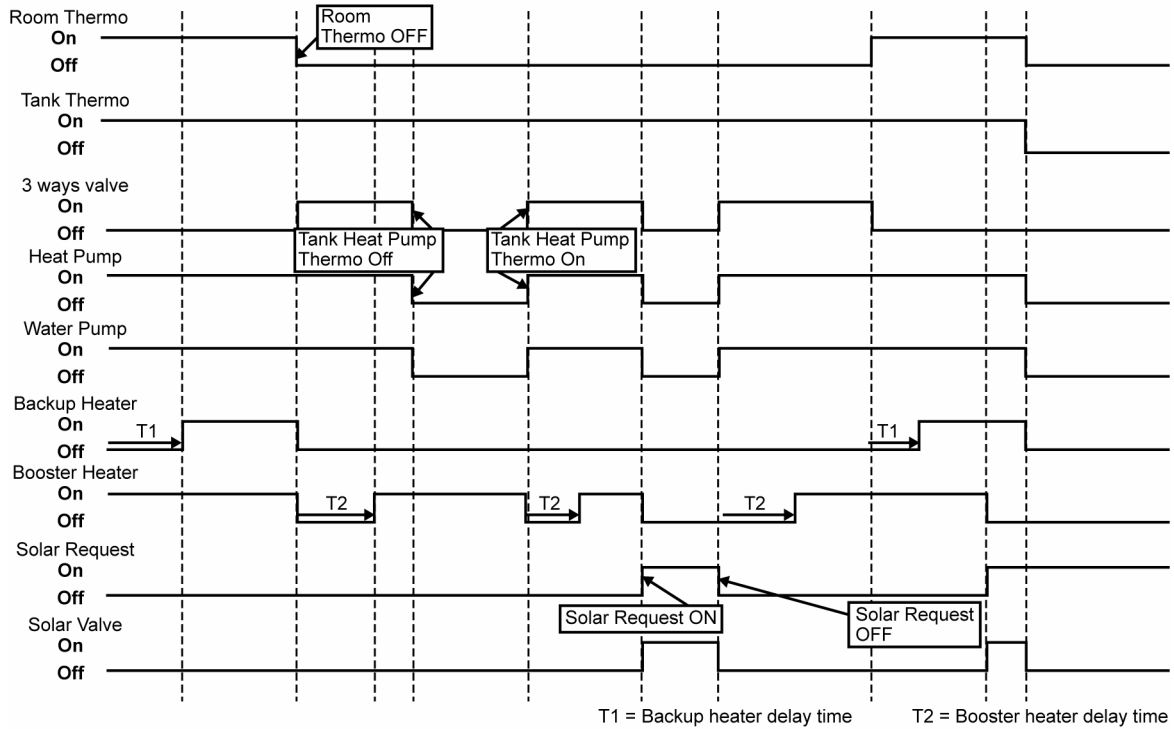

Under Solar Priority Not Set Condition:

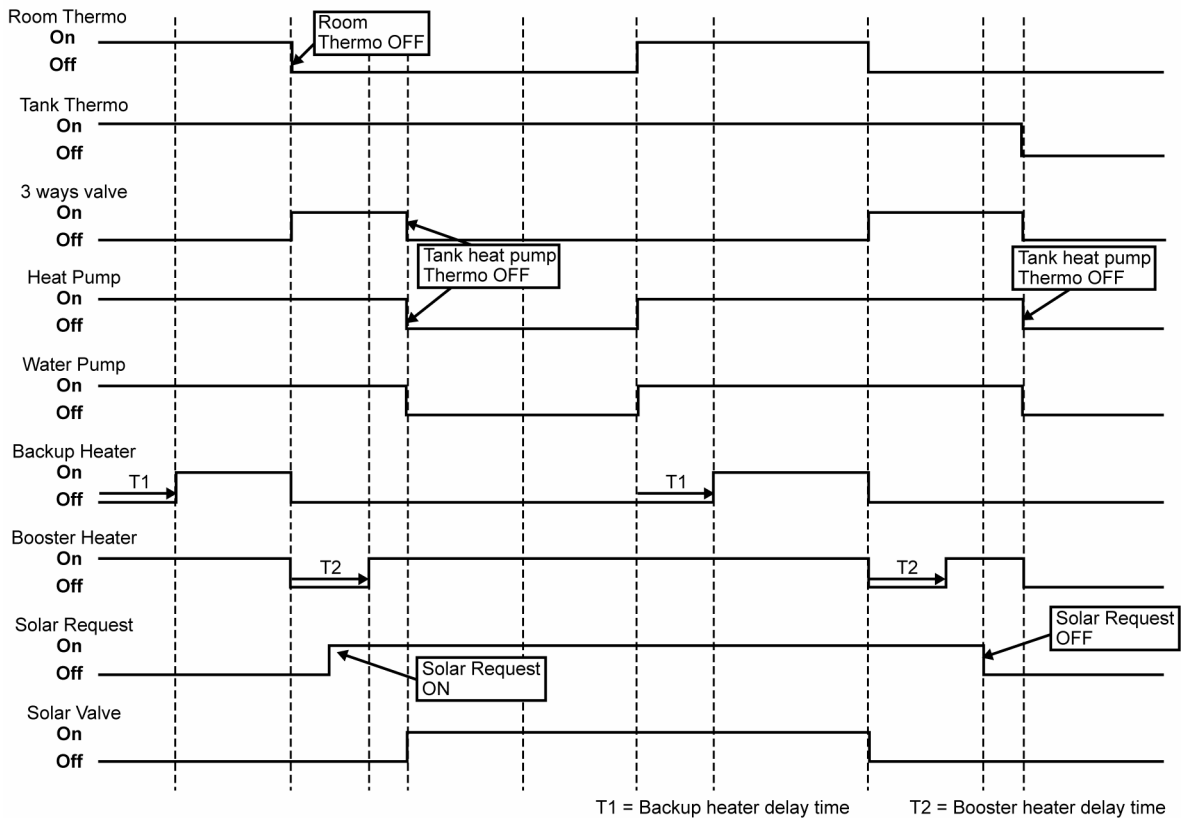

Setting 2: When heating priority is not set by remote control:

- When Solar Priority is set / not set by remote control:

1 3 ways valve control:

- 3 ways valve switch to room side during heating heat-up interval, and switch to tank side during tank heat-up interval. Both mode will switch alternatively. Tank mode is the Initial running mode of this heat + tank mode (heating no priority).

2 Heat pump operation control:

- During heating heat-up interval

- Follow normal heating operation.

Under solar priority set condition:

- Switch to tank heat-up interval and start counting tank heat-up timer when External Room Thermo OFF **AND** solar 3WV OFF **AND** Tank temperature < THERMO ON TEMP (End Room Interval Early) **OR**

- Switch to tank heat-up interval and start counting tank heat-up timer when tank temperature < THERMO ON TEMP **AND** solar 3WV OFF

Under solar priority not set condition:

- Switch to tank heat-up interval and start counting tank heat-up timer when External Room Thermo OFF **AND** Tank temperature < THERMO ON TEMP (End Room Interval Early) **OR**

- Switch to tank heat-up interval and start counting tank heat-up timer when tank temperature < THERMO ON TEMP

* THERMO ON TEMP is defined form following Case1 to Case4.

- During tank heat-up interval

- Heat pump tank target temperature = Tank set temperature or [51°C] whichever lower

- Heat pump Water Outlet set temperature is set to Maximum [55°C] during tank interval

- Initial Tank THERMO ON TEMP = heat pump tank target temperature + [-2°C]

Case 1:

- THERMO OFF TEMP:

1. THERMO OFF TEMP = Heat pump tank target temperature + [0°C].

2. Tank temperature > THERMO OFF TEMP for continuous 10 seconds after heat pump off due to water thermo, switch 3 ways valve to room side. End Tank heat-up interval and start count heating heat-up interval.

- THERMO ON TEMP:

1. THERMO ON TEMP = Heat pump tank target temperature + [-2°C].

2. After Heating heat-up interval, always detect tank temperature. Switch to next tank heat-up interval when tank temperature < THERMO ON TEMP

Case 2:

- Heat pump THERMO OFF TEMP:

1. Heat pump THERMO OFF TEMP = 55°C + [+2°C].

2. Water outlet temperature > Heat pump THERMO OFF TEMP for continuous 3 minutes, heat pump OFF.

- THERMO ON TEMP:

1. THERMO ON TEMP = Water inlet temperature, when heat pump thermo off + [-3°C].

Case 3:

- Heat pump THERMO OFF TEMP:

1. Water inlet temperature > 55°C for continuous 60 secs, heat pump OFF.

- THERMO ON TEMP:

1. THERMO ON TEMP = Water inlet temperature < 55°C.

Case 4 (Only during solar priority is set condition):

- When solar pump ON, tank heat-up interval end early and 3 ways valve switch to room side.

- THERMO ON TEMP:

1. THERMO ON TEMP = Heat pump tank target temperature + [-2°C].

2. After Heating heat-up interval, always detect tank temperature. Switch to next tank heat-up interval when tank temperature < THERMO ON TEMP and solar 3 way valve OFF.

- Tank interval will end and start heating interval timer, IF
 - * When this condition happen at tank side before case 1 thermo-off. 3WV switch to room side compulsory and continue until complete room interval.
 - 1. Tank interval timer finish AND External Room Thermo ON **OR**
 - 2. Fulfill above Case 1 of thermo off condition.
- 3 Backup heater control:
 - o During heating heat up interval.
 - Follow normal backup heater control operation.
 - o During tank heat-up interval.
 - Backup heater OFF during this interval.
- 4 Booster heater control:
 - o During heating heat-up interval.
 - Booster heater ON/OFF according to booster heater operation control.
 - o During tank heat-up interval.
 - Once switch from heating heat-up interval to tank heat-up interval, turn off the booster heater and start counting the BOOSTER HEATER DELAY TIMER.
 - Booster heater turn ON after BOOSTER HEATER DELAY TIMER fulfill and tank temperature lower than tank set temperature.
 - BOOSTER HEATER DELAY TIMER is clear when switch to heating heat-up interval.
- 5 Solar 3 way valve:
 - o Solar 3WV operates follow solar operation specification.
 - * Under solar priority is set condition, when solar 3WV is ON, booster heater turn OFF
 - * Under solar priority is not set condition, solar 3WV only can ON during heating heat-up interval.
- 6 2 way valve opens.

Heat + Tank Mode (Heating priority not set)

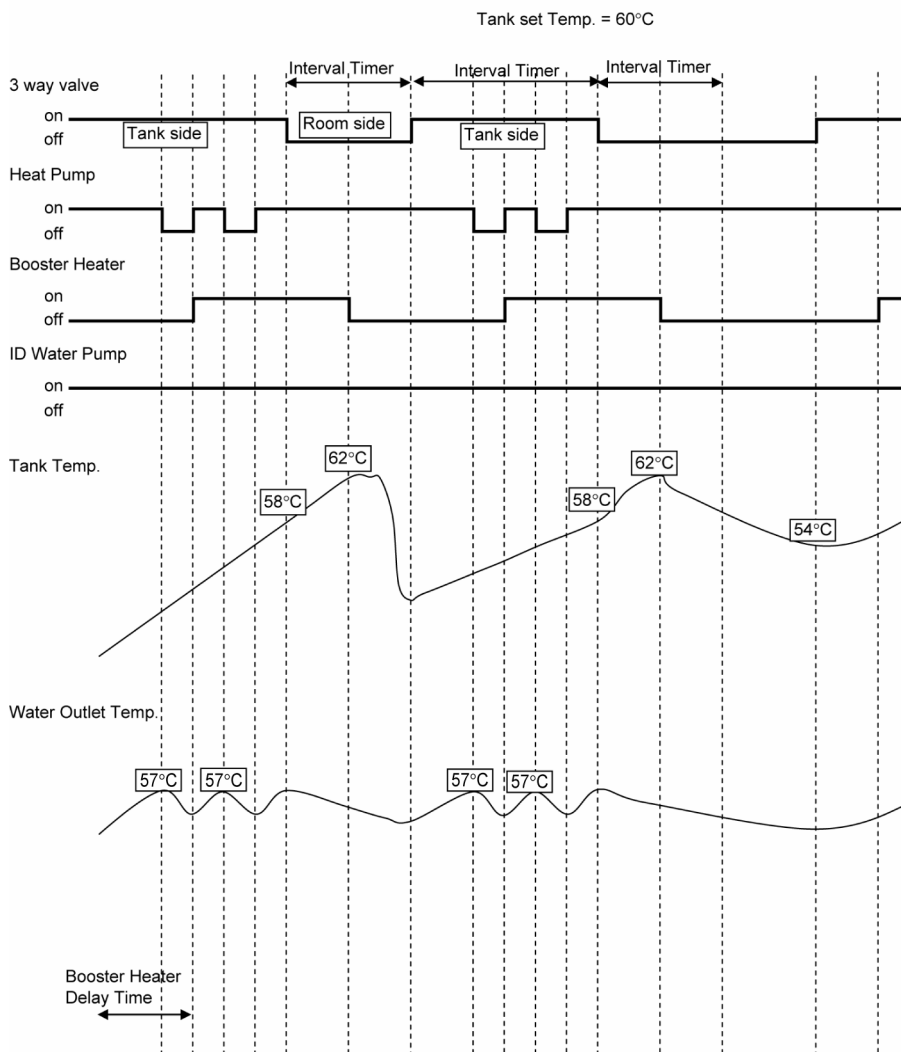

Under Solar Priority Set Condition:

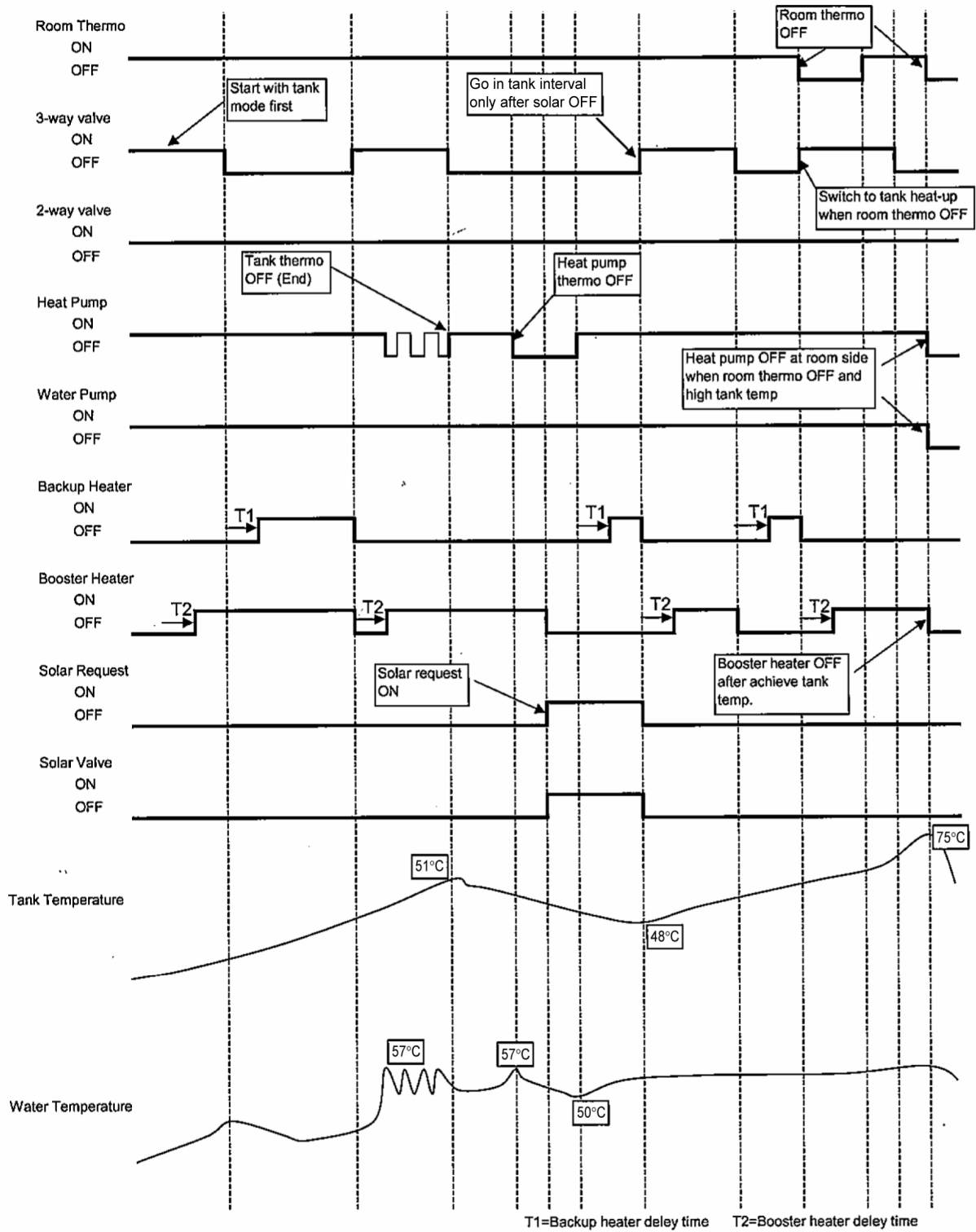

Under Solar Priority Not Set Condition:

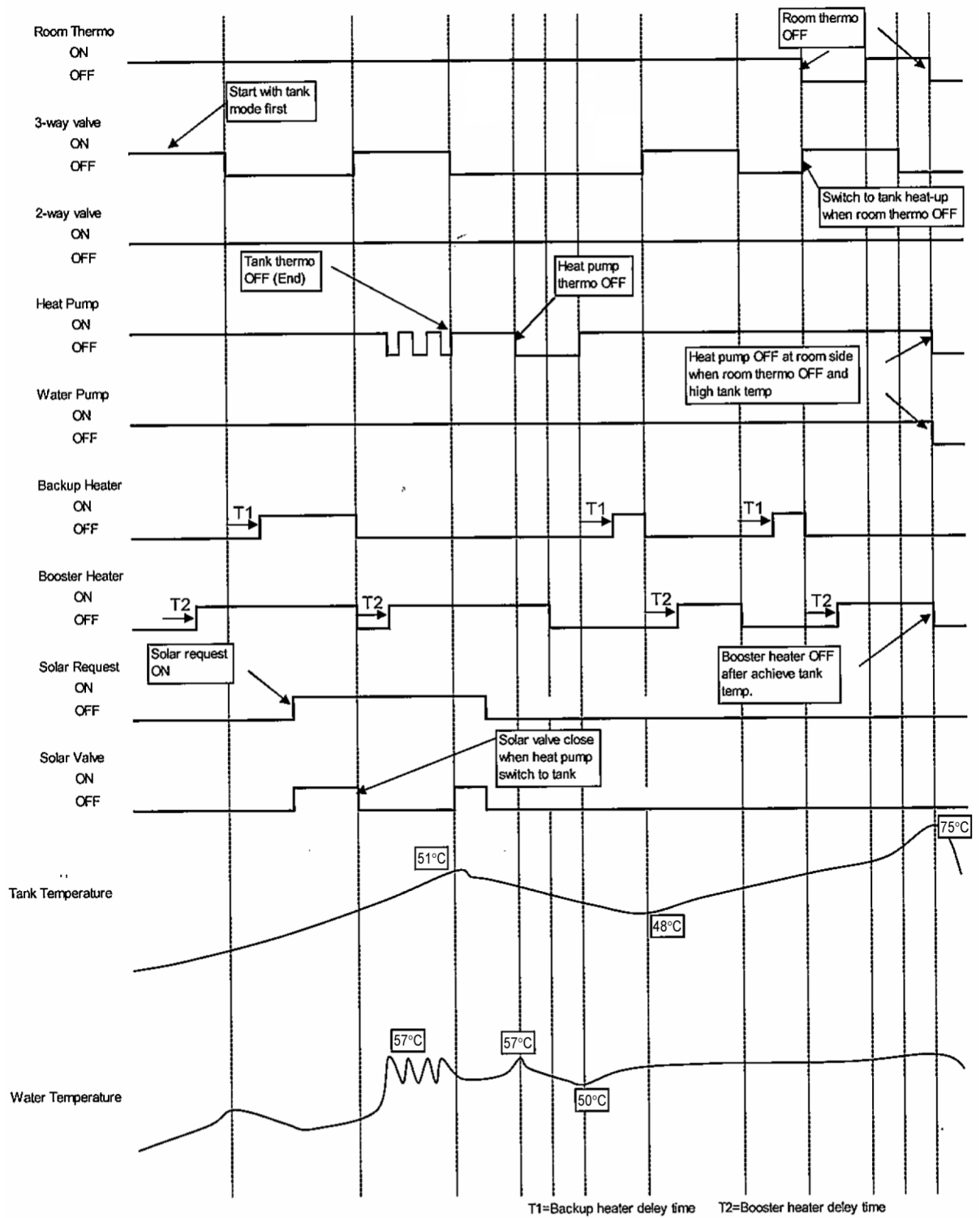

12.1.5 Setting Water Outlet Temperature for Heat Mode

- The set temperature define the parameters for the outdoor ambient temperature dependent operation of the unit. Where by the internal water setting temperature is determined automatically depending on the outdoor temperature. The colder outdoor temperatures will result in warmer water and vice versa. The user has the possibility to shift up or down the target water temperature by remote control setting.

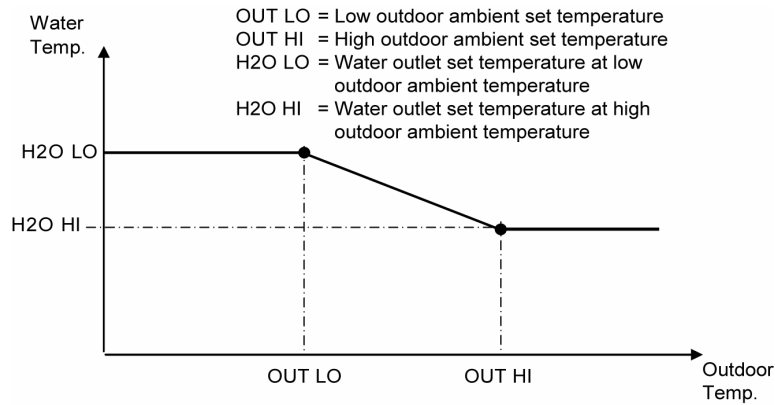

- Change in setting water outlet temperature is updated every 30 minutes.

12.1.5.1 Heating Mode Operation Time Chart

- Operation of heat pump provide heating capacity to room side by hot water through heating panel, floor or fan coil.
 - 3 ways valve control:
 - 3 ways valve switch and fix to heating side.
 - Heat pump operate follow normal heating operation.
 - Backup heater operate follow normal operation.
 - Solar 3 way valve operates follow solar operation specification.
 - 2 way valve opens.

12.1.6 Water Temperature Thermo Shift Setting

- Switches are ignored during "PUMPDW" = ON.
 - Switches are ignored during "STATUS" = ON.
 - "▲", "▼", "SELECT" switch are ignored if "SETTING" = OFF.
 - "CANCEL" switch is ignored if "SETTING" = OFF & "STATUS" = OFF.
 - If "SET" Switch pressed for less than 5secs, immediately enter water temperature shift setting mode.
 - Once enter this setting mode, "SETTING" display is ON.
- This setting mode is used to easily shift the target water outlet temperature.

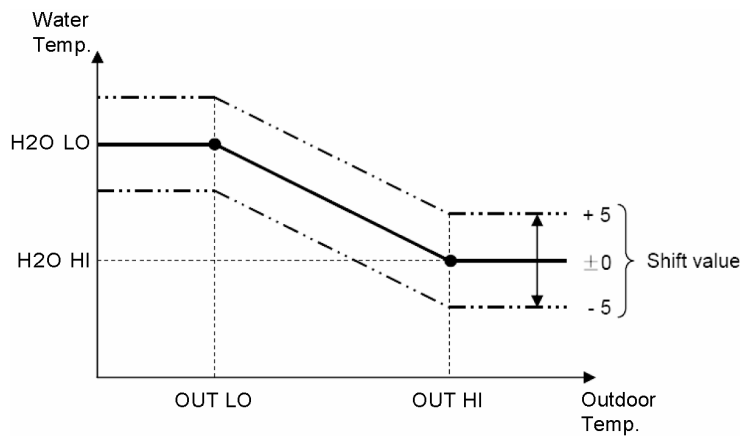

OUT LO = Low outdoor ambient set temperature
 OUT HI = High outdoor ambient set temperature
 H2O LO = Water outlet set temperature at low outdoor ambient temperature
 H2O HI = Water outlet set temperature at high outdoor ambient temperature
 Shift value = Setting water temperature thermo shift

12.1.7 Fan Motor Operation

Fan motor is adjusted according to operation condition. It starts when compressor starts operation and it stops 30 seconds after compressor stops operation.

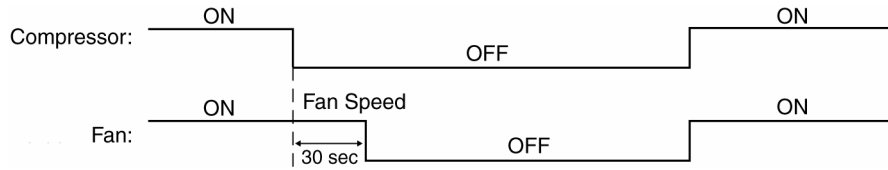

12.2 Water Pump

12.2.1 Water Pump Control

- Once the indoor unit is ON, the water pump will be ON immediately and no error judgement for 9 minutes. However, during this 9 minutes operation, if there is any abnormality cause at outdoor or malfunction, the compressor should be OFF immediately and restart delay after 3 minutes.
- The system will start checking on the water flow level after operation start for 9 minutes. If water flow level is detected low continuously for 10 secs, the water pump and compressor will be OFF permanently and OFF/ON remote control LED will blink (H62 error occurs).
- When error happen, the power has to be reset to clear the error.
- If there is no error indication, the water pump shall be continuously running.
- The water pump will remain ON when compressor OFF due to thermostat OFF setting is reached.

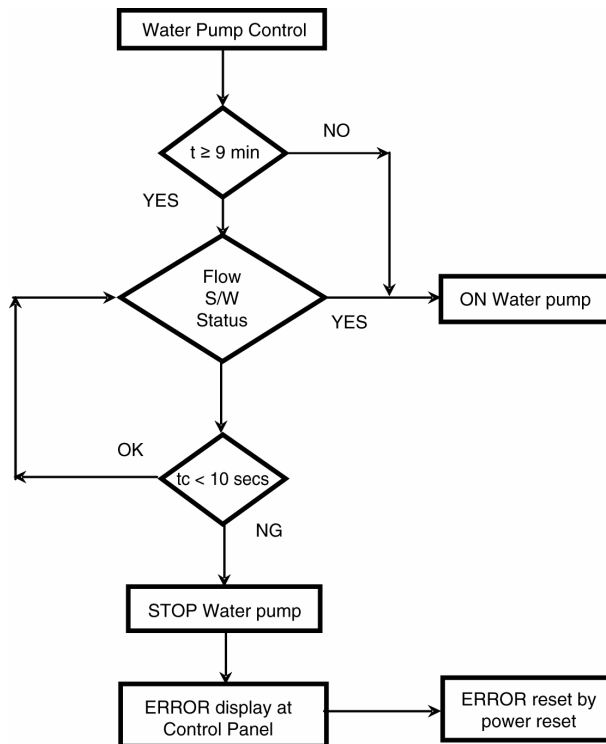

12.2.2 Water Pump Only Operation

- Water pump only circulation can be set from the control panel SERVICE S/W when the operation is in Standby Mode.
- Press the SERVICE S/W for continuous 5sec to enter Service Mode.
- In Service Mode, select Sr:02 and press SET S/W to start water pump only operation.
- Water pump will stop operation when H62 is triggered.
- Press the OFF/ON button to stop the water pump only operation.

12.3 Pump Down Operation

Purpose

Ensure the pump down operation when relocating or disposing of the unit. The pump down operation will extract all refrigerant from the piping into the mono bloc unit.

- Pump down operation control:
 - 1 Press the SERVICE S/W for continuous 5 secs to enter Service mode.
 - 2 In service mode, select Sr:01 and press SET S/W to start Pump Down operation.
 - 3 There will be no Low Pressure error & Freeze prevention judgement during pumpdown operation.
 - 4 3 ways valve will shift to room side.
 - 5 Press the ON/OFF button to stop the unit.

12.4 Flow Switch

12.4.1 Flow Switch Control

- 1 The water flow switch serve as an overload protector that shuts down the unit when the water level is detected to be low.
- 2 Detection is Lo (0V) when there is no water flow, and detection is Hi (5V) when there is water flow.

12.5 Force Heater Mode Operation

The backup heater also serves as backup in case of malfunctioning of the mono bloc unit.

- 1 Make sure the OFF/ON remote control LED is OFF (no operation).
- 2 Press the Force button to start the force heater mode operation.
- 3 During force heater mode, all other operations are not allowed.
- 4 Press OFF/ON button to stop the force heater mode operation.

12.6 Mono Bloc Unit Safety

12.6.1 Mono Bloc Unit Safety Control

- 1 When water pump is ON, the system will start checking flow switch status (ON/OFF).
- 2 If the flow switch ON for 10 seconds, the system will check on the water inlet temperature for 10 seconds. If the water inlet temperature not exceeds 80°C, the water pump shall be continuously running with normal mode.
If the water inlet temperature exceeds 80°C for continuously 10 seconds, the water pump will be OFF immediately.
- 3 After water pump OFF for more than 10 minutes, it will be ON back and the indoor unit safety control checking is restarted.

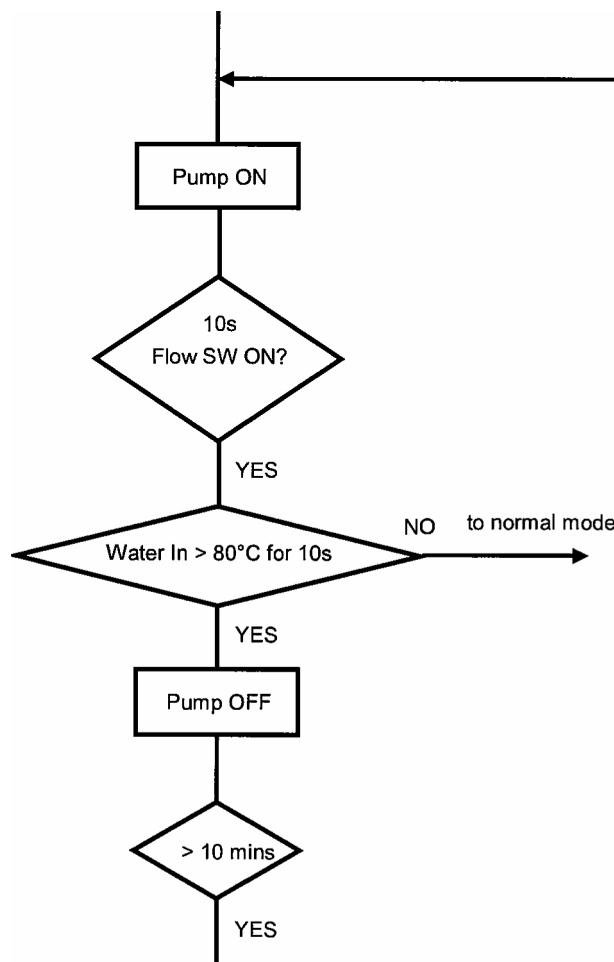

12.7 Auto Restart Control

When the power supply is cut off during the operation of Mono Bloc unit, the compressor will re-operate after power supply resumes.

12.8 Indication Panel

LED	Operation
Color	Green
Light ON	Operation ON
Light OFF	Operation OFF

Note:

- If Operation LED is blinking, there is an abnormality operation occurs.

12.9 Back-Up Heater Control

12.9.1 Electric Heater Control

- 1 Normal Heating Mode
 - Heater On condition:
 - a. Heater switch is ON
 - b. After Heatpump thermo ON for **[30]** mins
 - c. After water pump operate **[9]** mins
 - d. Outdoor air temperature < Outdoor set temperature for heater
 - e. **[20]** minutes since previous Backup heater Off
 - * When heatpump cannot operate due to error happens during normal operation, heater will go into force mode automatic
 - * Heater need to operate during deice operation
 - f. When water outlet temperature < Water set temperature + **[-8°C]** (check water out temperature before ON heater 3 and check also water out temperature after heater delay timer before ON heater 2 and 1)
 - Heater Stop Condition:
 - a. When outdoor set temperature > outdoor set temperature + **[+2°C]** for continuous 15 secs OR
 - b. When water out temp > water set temperature + **[-2°C]** for continuous 15 secs OR
 - c. Heater switch is Off OR
 - d. Heat pump thermo-off or OFF condition
- 2 Force Heater Mode
 - Heater On Condition:
 - a. After water pump operate **[9]** mins
 - b. When water outlet temperature < water set temperature + **[-8°C]**
 - c. **[20]** minutes since previous Backup heater Off
 - Heater Stop condition
 - a. Force mode off **OR**
 - b. When water outlet temperature > water set temperature + **[-2°C]** for continuous 15 secs

* Do not operate heater at the following situation

- 1 Water outlet temperature sensor, and water inlet sensor abnormal
- 2 Flow switch abnormal
- 3 Circulation pump stop condition
- 4 During Heatpump switch to tank side

12.10 Tank Booster Heater Control

12.10.1 Tank Booster Heater Control

Heating operation condition:

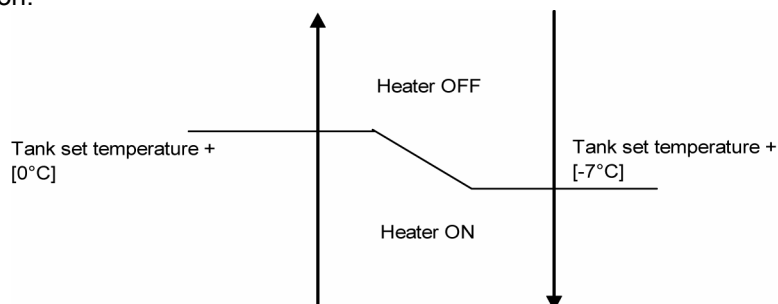

- 1 Booster heater Turn On condition:
 - After BOOSTER HEATER DELAY TIMER fulfill during heat pump startup time in tank mode, or during switching from heating heat-up interval to tank heat-up interval in heat + tank mode (heating priority not set).
 - Tank temperature < Tank set temperature + **[-7°C]**,
 - 20 minutes since previous heater off.

* BOOSTER HEATER DELAY TIMER is clear when tank heat-up interval end.

- 2 Booster heater Turn Off condition:
 - Tank temperature > Tank set temperature + [0°C] for continuous 15 secs
 - When BOOSTER HEATER DELAY TIMER start count after switch from heating heat-up interval to tank heat-up interval

* DELAY TIMER can be set by remote control.

12.11 Base Pan Heater Control (Optional)

- To enable the base pan heater function, pin 3 of SW2 of water system PCB has to be switched from OFF to ON position.

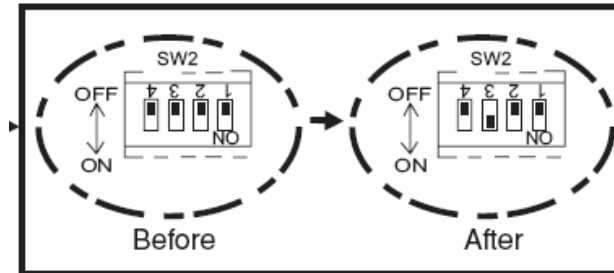

- Base pan heater ON condition:
 - When outdoor ambient temperature $\leq 3^{\circ}\text{C}$ AND
 - Deice operation ON

Base pan heater will continue ON for 10 minutes after deice operation ends.
- Base pan heater OFF condition:
 - When outdoor ambient temperature $> 3^{\circ}\text{C}$ OR
 - When operation is not heating OR
 - Base pan heater ON timer count completed

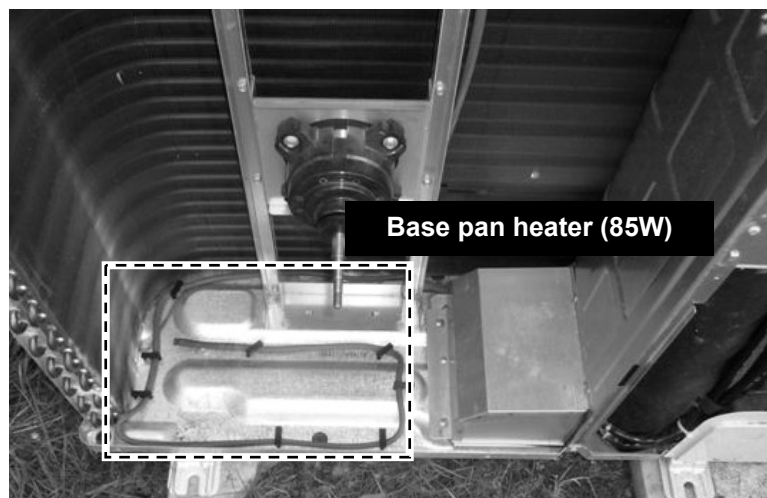

12.12 Three Way Valve Control

- Purpose:
 - 3 ways valve is used to change flow direction of hot water from heat pump between heating side and tank side
- Control contents:
 - 1 3 ways valve switch Off:
 - During 3 ways valve switch Off time, the hot water will provide heat capacity to heating side.
 - 2 3 ways valve switch On:
 - During 3 ways valve switch On time, the hot water will provide heat capacity to tank side.
 - 3 Stop condition:
 - During stop mode, 3 ways valve will be in switch off position

12.13 Sterilization Mode

- Purpose:
 - Boil tank temperature to customer set boiling temperature to operate sterilization.
- Control start condition:
 - Tank connection set to YES by remote controller
 - Sterilization function selection is YES
 - Sterilization signal received from remote controller by timer.
- Control stop condition:
 - After boiling timer completed. Boiling timer start counting once tank achieve boiling set temperature OR
 - After 4 hours of operation since sterilization function start OR
- Control content:
 - Once the sterilization function enable, set the target tank temperature to Boiling Set Temperature.
 - Booster heater will allow to ON during solar priority SET condition.
 - Booster heater OFF Temp. = Boiling Set Temperature 0°C
 - Booster heater ON Temp. = Boiling Set Temperature - 7°C
 - The sterilization set temperature may not achieve if tank booster heater function is deactivated.
 - Boiling timer which set by remote controller will start count after tank achieve boiling set temperature.
 - Sterilization operation will end after complete boiling timer or Max 4 hrs from function start.
 - Target tank temperature will set back to normal tank set temperature.

* Tank heater control is not affected by solar pump when solar priority set.

12.14 Quiet Operation

- Purpose:
 - To provide quiet operation compare to normal operation by reduces mono bloc unit noise.
- Starting condition:
 - 1 When quiet button is presses.
 - 2 When quiet request ON time by weekly timer (Refer to remote control.)
- When any of above mentioned condition is achieved, this control is activated.
New target FM speed = Present target FM speed - 80 rpm
Minimum target FM speed = 200 rpm
- Cancellation condition:
 - 1 Cancel by press quiet button
 - 2 Stop by OFF/ON button
 - 3 When quiet request OFF time by weekly timerWhen any of above mentioned condition is achieved, this control is cancelled.

12.15 Anti Freeze Control

- Anti freeze protection control can be select YES or NO from control panel. Default setting is YES.
- In heatpump system, there are 2 types of anti freeze control:
 1. Water pump circulation anti frost control
 - Water pump turns ON when **ALL** the below conditions are fulfilled:
 - Heatpump OFF (standby) OR water pump stop (Tank Mode) OR error occurs
 - Water flow switch is not abnormal
 - Outdoor ambient temp. < 3°C
 - Water inlet/outlet temp. < 6°C
 - After 5 minutes from previous water pump OFF
 - Water pump turns OFF when **ANY** of the below conditions is fulfilled:
 - Outdoor ambient temp. ≥ 4°C
 - During -5°C < outdoor ambient temp. < 4°C
 - After water pump ON for 4 minutes, and water inlet/outlet temp. ≥ 8°C
 - Else, shift to backup heater anti freeze control
 - During outdoor ambient temp. < -5°C
 - After water pump ON for 4 minutes, and water inlet/outlet temp. ≥ 20°C
 - Else, shift to backup heater anti freeze control
 - However, if flow switch is abnormal (H62), then water pump circulation anti freeze control will not activate.

2. Backup heater anti freeze control:
 - Backup heater turns ON when **ALL** the below conditions are fulfilled:
 - Water inlet/outlet temp. < 6°C
 - Water pump circulation anti freeze control activated, and water pump ON for 4 minutes
 - Backup heater turns OFF when **ANY** of the below conditions is fulfilled:
 - Water inlet/outlet temp. > 28°C
 - Water pump circulation anti freeze control deactivated/water pump OFF
- However, if backup heater is abnormal (H70), then backup heater anti freeze control will not activate.

12.16 Solar Operation (Optional)

12.16.1 Solar Operation

- 1 External solar heat source signal can be connect to unit for proper control of heat source switching during tank boiling time.
- 2 Control according to preset whether solar priority is set or not.
- 3 When tank connection is NOT set at SETTING mode, solar operation is disabled.
- 4 When Pump A (from solar pump station) is detected On through connection Y3 and Y4, then the Solar pump 3 Way Valve is requested ON (Refer to figure below).

Connecting diagram with the Solar Pump Station

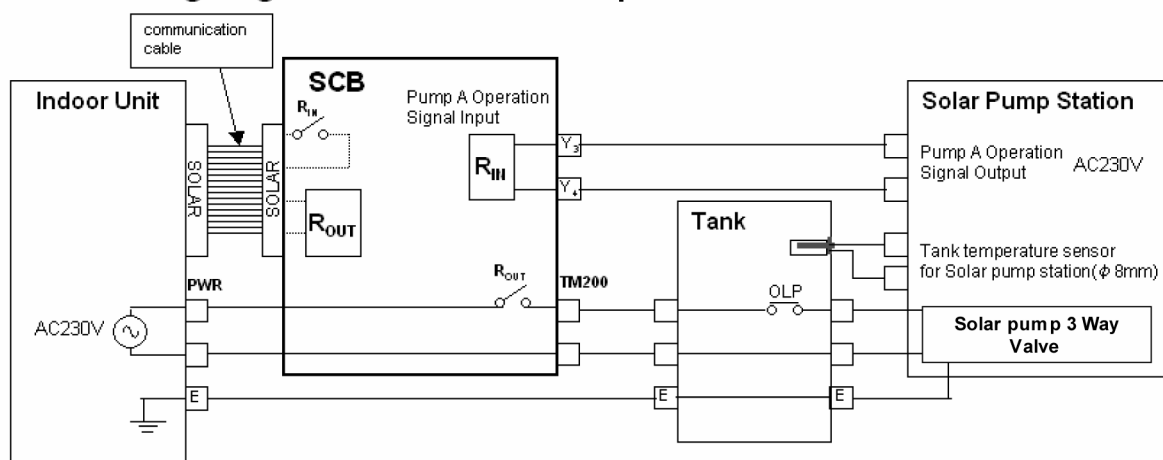

12.16.2 Solar Operation Control

When solar priority is SET

- 1 Operation condition:
 - a 3 way valve operates if all of the following conditions are fulfilled:
 - Power On. (regardless operation ON or OFF)
 - There is operation request from solar pump station.
 - Tank hot water temp is below solar on upper limit temp 72°C.
- 2 Stop condition:
 - a 3 way valve stops operating when:
 - No power supply to unit **OR**
 - There is **NO** operation request from solar pump station **OR**
 - Tank hot water temp is above solar off upper limit temp 80°C.

* heat pump OFF OR operate to room side when solar pump operate during solar priority set.
 * booster heater OFF when solar pump operate during solar priority set.

When solar priority is NOT SET

- 1 Operation condition:
 - a 3 way valve operates if all of the following conditions are fulfilled:
 - Power On. (regardless operation ON or OFF).
 - There is operation request from solar pump station.
 - Tank hot water temp is below solar on upper limit temp 72°C.
 - Heat pump thermo OFF in tank mode OR Heat pump operate to room side (during operation ON and tank mode selected).

2 Stop condition:

a 3 way valve stops operating when:

- No power supply to unit **OR**
- There is **NO** operation request from solar pump station **OR**
- Tank hot water temp is above solar off upper limit temp 80°C.
- Heat pump thermo ON and operate to tank side. (during operation ON and tank mode selected).

Heat + Tank Mode (Heating priority not set)

(Solar Priority Set)

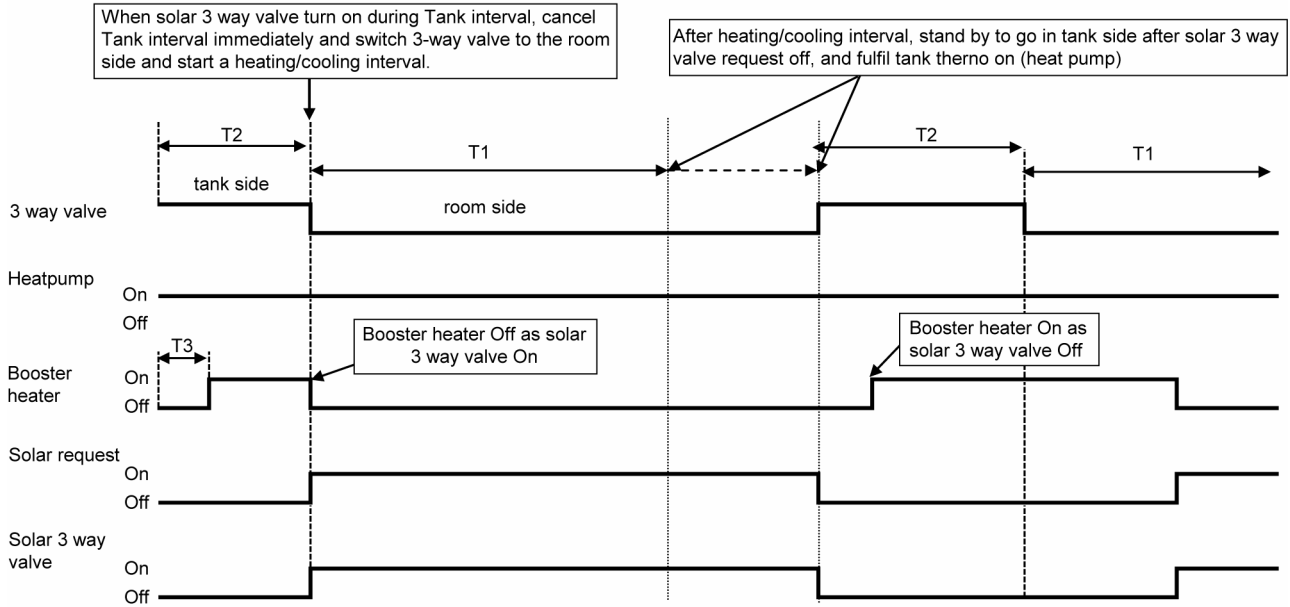

(Solar Priority Not Set)

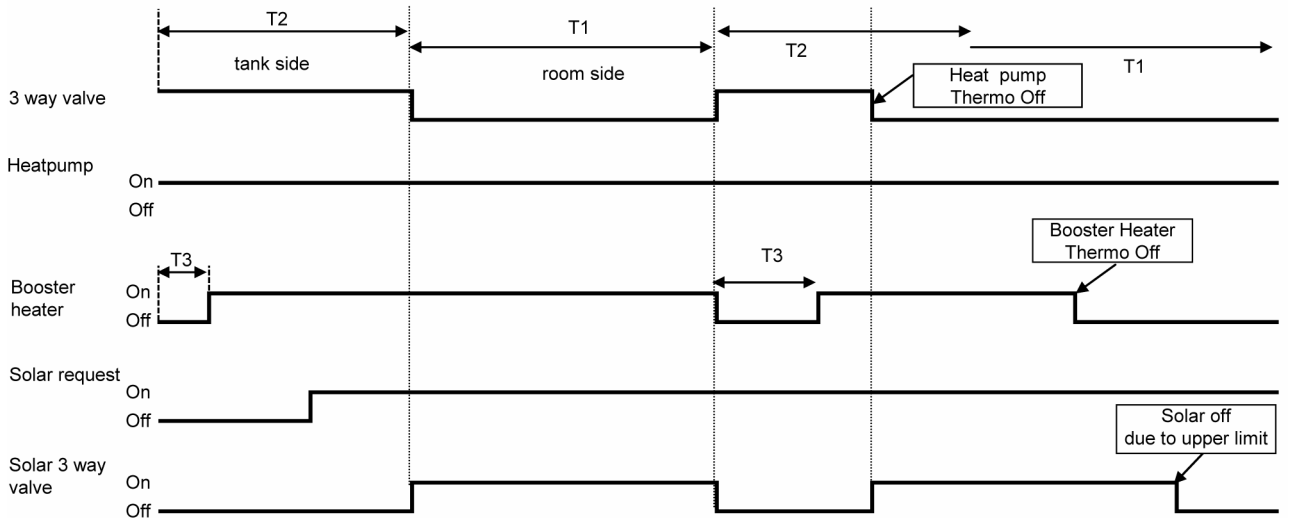

T1 - Heating
 T2 - Tank interval
 T3 - Booster heater delay timer

Heat + Tank Mode (Heating Priority Set)

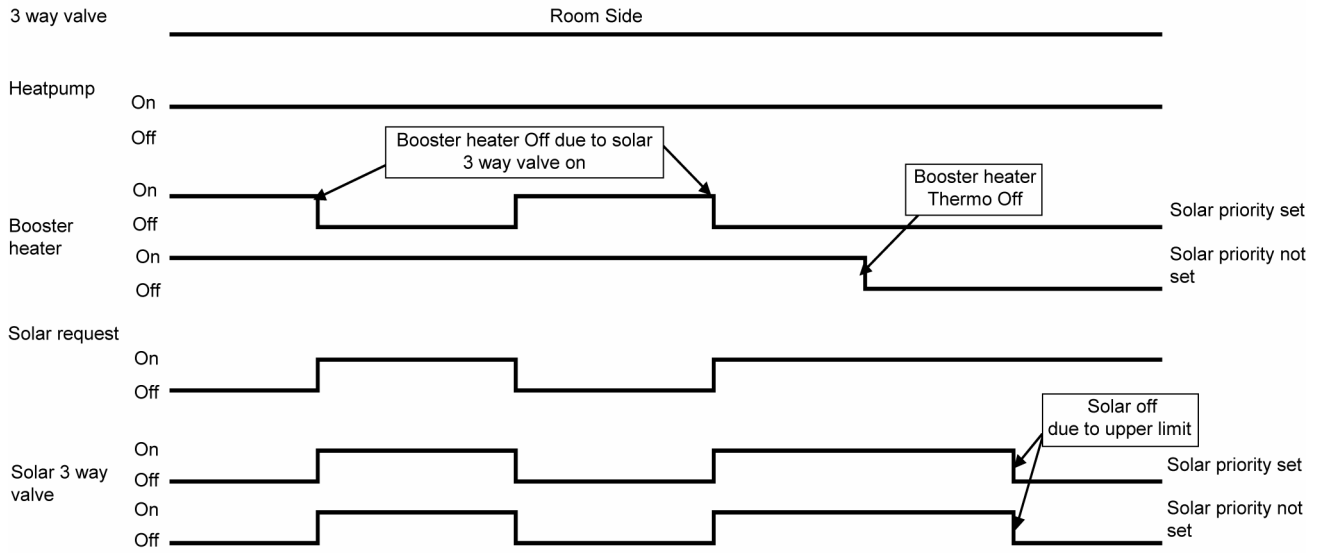

Tank Mode [Solar priority SET condition]

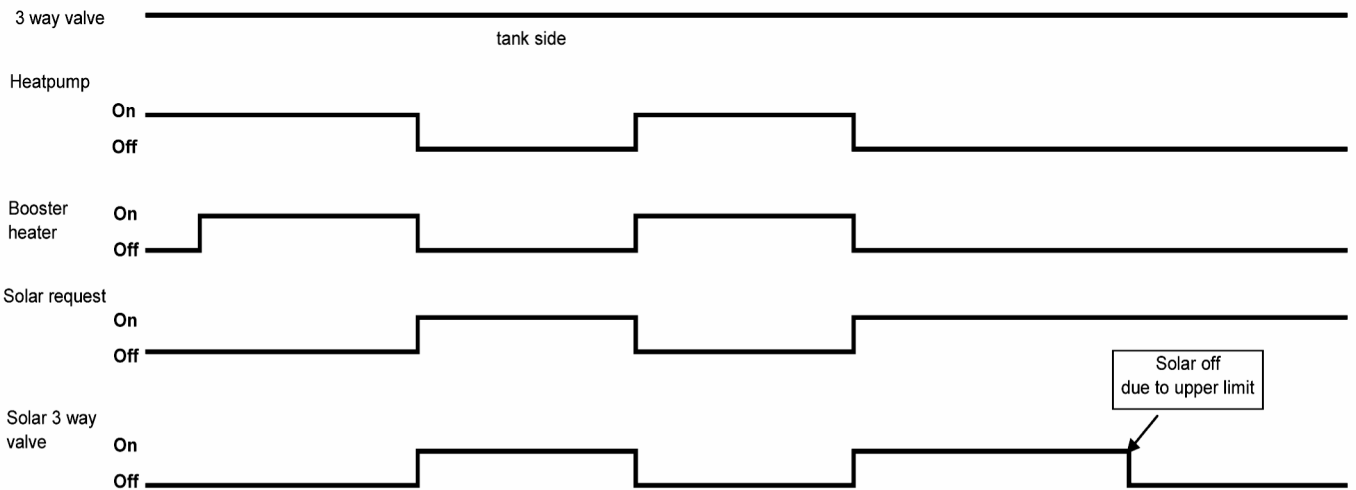

Tank Mode [Solar priority NOT SET condition]

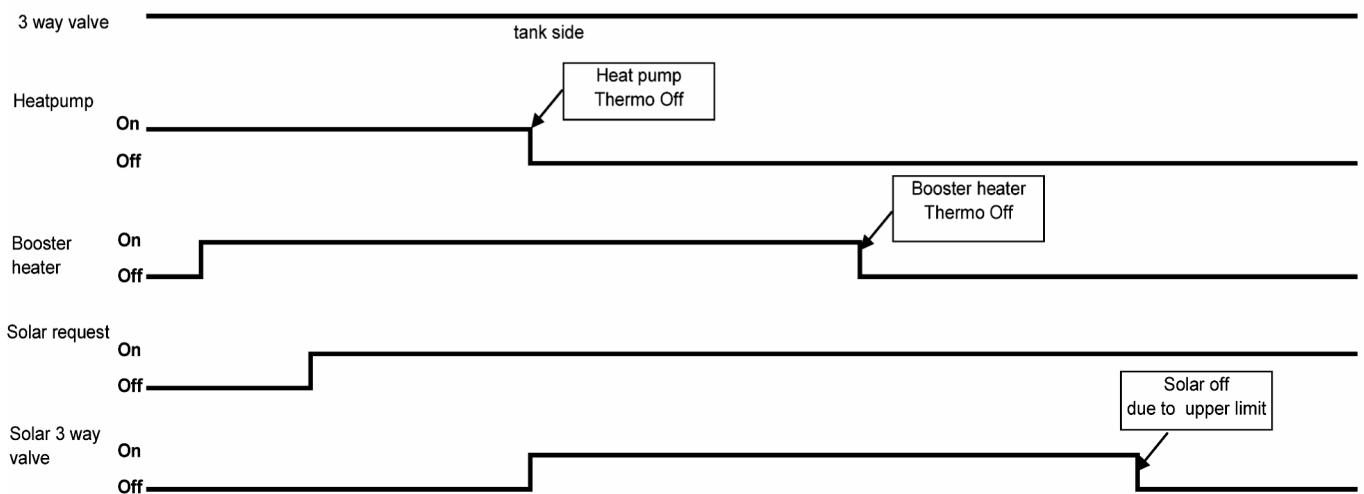

12.17 External Room Thermostat Control (Optional)

Purpose:

- Better room temperature control to fulfill different temperature request by external room thermostat.
Recommended external room thermostat:

Maker	Characteristic
Siemen (REV200)	Touch panel
Siemen (RAA20)	Analog

Connection external room thermostat:

Wire Connection and thermo characteristic of Siemen REV200:

Setting	L/L1 (H)	Heat Thermo	L/L2 (C)	Cool Thermo
Set Temp < Actual Temp	Open Circuit	OFF	Short Circuit	ON
Set Temp > Actual Temp	Short Circuit	ON	Open Circuit	OFF

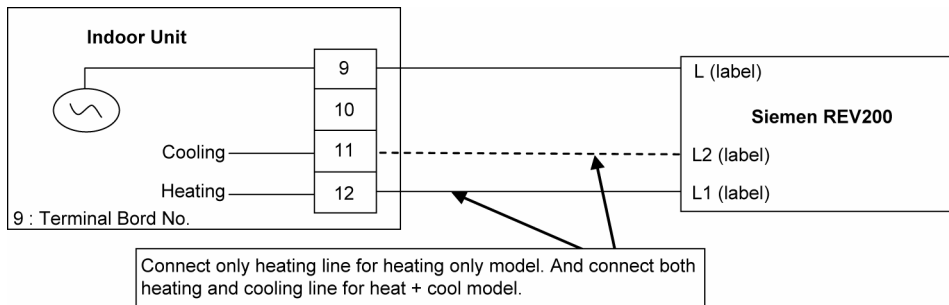

Wire Connection and thermo characteristic of Siemen RAA20:

Setting	L/Y1 (H)	Heat Thermo	L/Y2 (C)	Cool Thermo
Set Temp < Actual Temp	Open Circuit	OFF	Short Circuit	ON
Set Temp > Actual Temp	Short Circuit	ON	Open Circuit	OFF

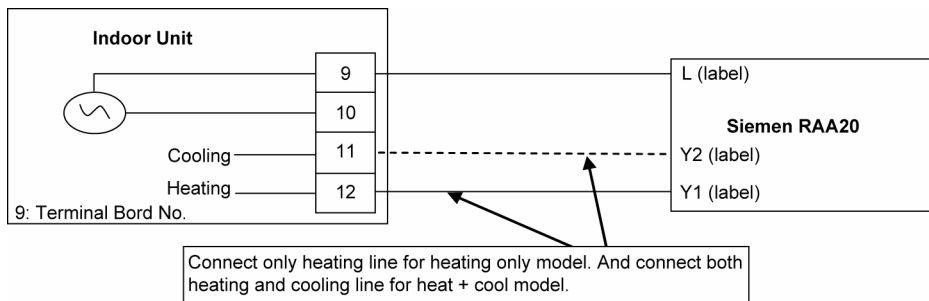

Control Content:

- External room thermostat control activate only when remote thermostat connection select YES by Indoor remote control.
- When indoor running heat mode, refer thermo On/Off from heating line feedback. And when indoor running cool mode, refer thermo On/Off from cooling line feedback.
- Heat pump Off immediately when receive thermo off feedback.

13. Protection Control

13.1 Protection Control For All Operations

13.1.1 Time Delay Safety Control

- 1 The compressor will not start for three minutes after stop of operation.

13.1.2 30 Seconds Forced Operation

- 1 Once the compressor starts operation, it will not stop its operation for 30 seconds.
- 2 However, it can be stopped using remote control.

13.1.3 Total Running Current Control

- 1 When the mono bloc unit running current exceeds X value, the compressor frequency will decrease.
- 2 If the mono bloc unit running current does not exceed X value, the compressor frequency will return to normal operating frequency.
- 3 If the mono bloc unit running current continue to increase till exceed Y value, compressor will stop, and if this occurs 3 times within 20 minutes, system will stop operation and OFF/ON remote control LED will blink (F16 error occurs).

Operation Mode	06E		09E	
	X (A)	Y (A)	X (A)	Y (A)
Heating	19.5	27.9	22.7	27.9

13.1.4 IPM (Power transistor) Prevention Control

A. Overheating Prevention Control

- 1 When the IPM temperature rises to 95°C, compressor will stop immediately.
- 2 Compressor will restart delay 3 minutes when the IPM temperature decreases to 90°C.
If this condition repeats continuously 3 times within 30 minutes, system will stop operation and OFF/ON remote control LED will blink (F22 error occurs).

B. DC Peak Current Control

- 1 When the current to IPM exceeds set value of 40.1 ± 5.0 A compressor will stop. Compressor will restart after three minutes.
- 2 If the set value exceeds again for more than 30 seconds after the compressor restarts, operation will restart after two minutes.
- 3 If the set value exceeds again for within 30 seconds after the compressor restarts, operation will restart after one minute. If this condition repeats continuously for seven times, system will stop operation and OFF/ON remote control LED will blink (F23 error occurs).

13.1.5 Compressor Overheating Prevention Control

- The compressor operating frequency is regulated in accordance to compressor tank temperature as shown in below figures. When the compressor tank temperature exceeds 112°C, compressor will stop, and if this occurs 4 times within 30 minutes, system will stop operation and OFF/ON remote control LED will blink (F20 error occurs).

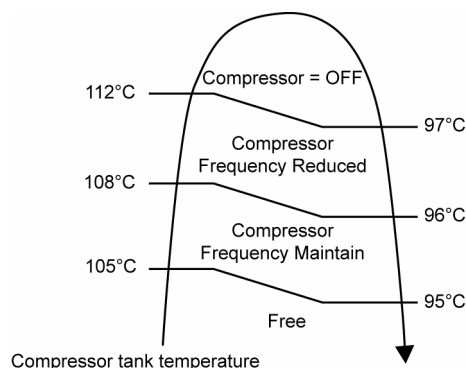

13.1.6 Low Pressure Protection Control

- Purpose:
 - To protect the system operation.
- Detection period:
 - After compressor on for 5 minutes.
- Detection conditions:
 - When detection of Tem above 30°C.
 - Calculation of average evaporation temperature (Tem).
 - Use outdoor low pressure sensor.
 - Tem use the value calculated for discharge temperature setting value
- After detection:
 - Compressor stops restart again after 3 mins.
 - When abnormalities continuously generated 60 times within 480 minutes
 - Protection is prohibited.
 - Error H42 will be displayed.

13.1.7 High Pressure Sensor Control

- Purpose:
 - To protect the system operation.
- Detection period:
 - After compressor on for 1 minute.
- Detection conditions:
 - When abnormal high voltage detection, 5V or when open circuit detection 0V for 5 seconds continuously.
- After detection:
 - When abnormality is detected continue 5 seconds, unit stop operation.
 - OFF/ON remote control LED will blink (H64 error occurs).

13.1.8 Outside Temperature Current Control

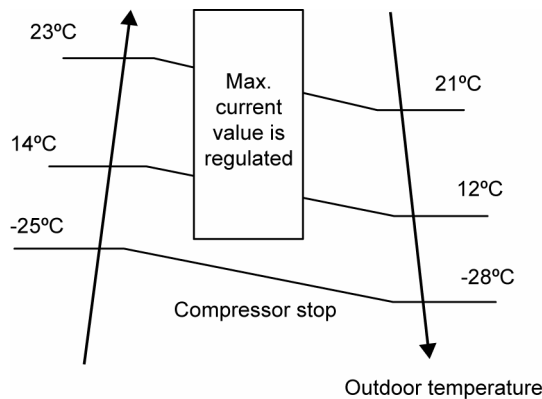

13.1.9 Extreme Low Temperature Control

- Purpose:
 - To improve the compressor reliability during cold start and after deice when running in extreme low outdoor temperature -20°C.
- Starting condition:
 - Heating operation
 - Outdoor air temperature < -10°C
 - Actual frequency \geq 50Hz
 - Compressor discharge temperature < 20°C

When the above condition is fulfilled, this control is activated.
5Hz up every 30 sec. until it reaches the target frequency.
- Cancellation condition:
 - starting condition not fulfill.
 - Cancel the extreme low temperature control when compressor discharge sensor \geq 60°C

13.1.10 Crank Case Heater Control

- Purpose:
 - For compressor protection during low outdoor ambient operation (during heating low temperature operation).
- Control content:
 - a. Trigger heater START condition
 - When the outdoor air temperature is 4°C or below, and discharge temperature is 12°C or below.
 - b. Resetting heater STOP condition
 1. when the outdoor air temperature 6°C.
 2. when the discharge temperature 19°C.

13.2 Protection Control for Heating Operation

13.2.1 Outdoor Air Temperature Control

The maximum current value is regulated when the outdoor air temperature rises above 14°C in order to avoid compressor overloading.

13.2.2 Deice Operation

When outdoor pipe temperature and outdoor air temperature is low, deice operation start where outdoor fan motor stop.

Mono Bloc Unit Deice Control

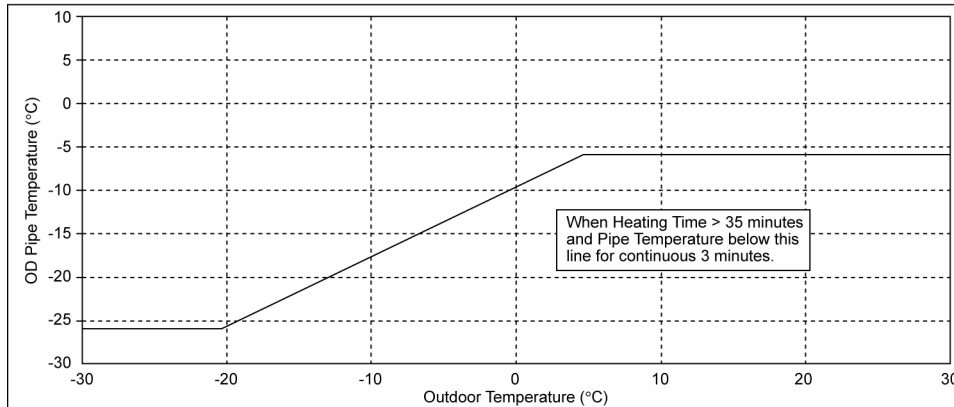

Deice start depends:

1. Outdoor air sensor temp.
2. Outdoor pipe sensor temp.
3. Heating accumulation time

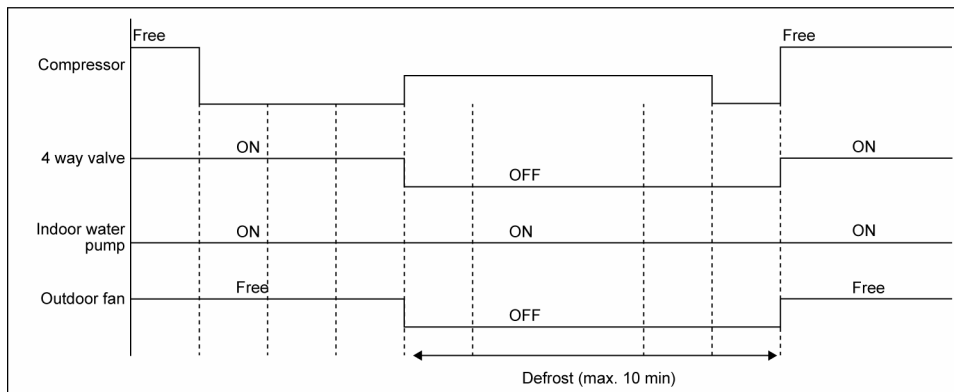

Deice end depends:

1. Outdoor pipe sensor temp. (06kW & 09kW models)
2. Outdoor defrost sensor temp. (12kW, 14kW & 16kW models)
3. Defrost max. time

13.2.3 Heat-exchanger (hot water coil) protection control

- Backup heater ON condition:-
 - water inlet temperature < 23°C **AND**
 - outdoor ambient temperature < 10°C
- Backup heater OFF condition:-
 - water inlet temperature > 25°C **OR**
 - outdoor ambient temperature > 13°C

14. Servicing Mode

14.1 Test Run

- 1 Fill up the Tank Unit with water. For details refer to Tank Unit installation instruction and operation instruction.
- 2 Antifreeze agent must be added into water circuit to prevent freezing of water when outdoor ambient temperatures is low. Recommended antifreeze:
Propylene glycol: 40% (equivalent to -20°C)
- 3 Set ON to the Mono bloc unit and RCCB. Then, for remote control operation please refers to (Mono bloc) Air-to-Water Heatpump's operation instruction.
- 4 For normal operation, pressure gauge reading should be in between 0.05 MPa and 0.3 MPa. If necessary, adjust the water pump speed accordingly to obtain normal water pressure operating range. If adjust water pump speed cannot solve the problem, contact your local authorized dealer.

14.2 Proper Pump Down Procedure

- Strictly follow the steps below for proper pump down procedure. Explosion may occur if the steps are not followed as per sequence.
 - 1 When the unit is not in operation (standby), press the "SERVICE" switch on remote control to enter SERVICE mode. Operate the system in Sr : 01 mode for pump down operation.
 - 2 After 10~15 minutes, (after 1 or 2 minutes in case very low ambient temperatures (< 10°C)), fully close 2 way valve.
 - 3 After 3 minutes, fully close 3 way valve.
 - 4 Press the "OFF/ON" switch on remote control to stop pump down operation.
 - 5 Remove the refrigerant piping.

14.3 How To Adjust Water Flow Rate

- Before adjust the water flow rate, make sure that the total water volume in the installation is 30 litres minimum for heating side and tank side respectively.
The default setting is Δp -c mode, SPEED 6. Please ensure the minimum flow rate is not less than 9L/min.
Depending on the hydraulic system pressure loss and type, the water flow rate can be adjusted by turning the red knob on the water pump.

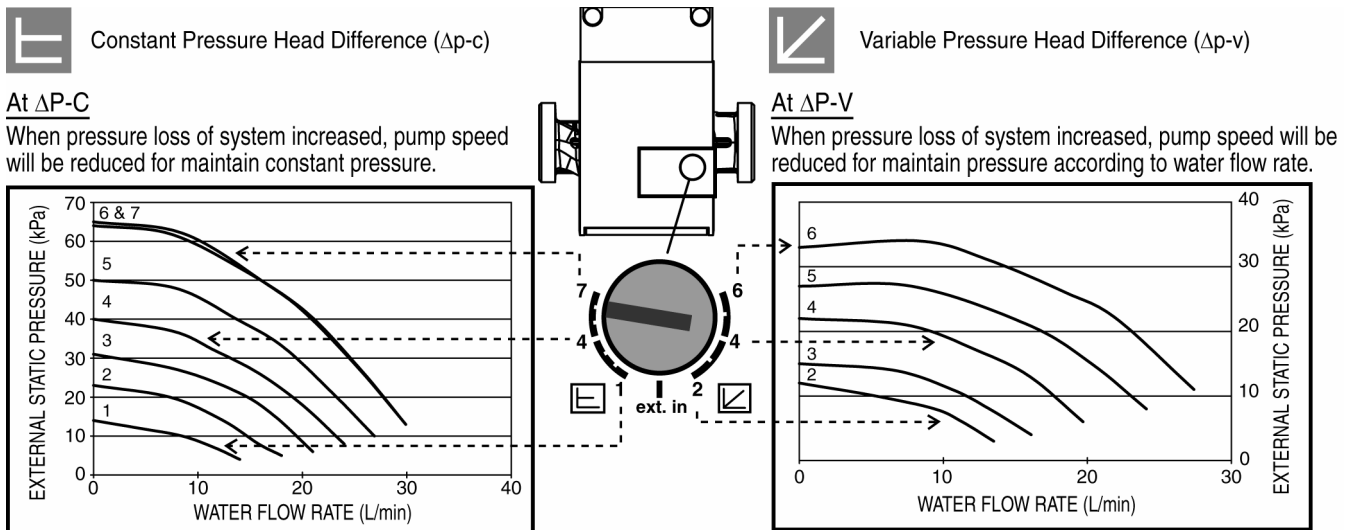

14.4 Expansion Vessel Pre Pressure Checking

- Expansion Vessel with 6 L air capacity and initial pressure of 1 bar is installed in this Mono bloc unit.
- Total amount of water in system should be below 150 L.
(Note: This amount of water is not include the tank unit volume)
- If total amount of water is more than 150 L, please install additional expansion vessel (field supply).
- Please keep the installation height difference of system water circuit within 10 m.
(Inner volume of same Mono bloc unit is about 3 L)

15. Maintenance Guide

In order to ensure optimal performance of the unit, seasonal inspections on the unit, external filter and field wiring have to be carried out at regular intervals. This maintenance should be carried out by authorized dealer.

1 Water pressure

Water pressure should not lower than 0.05 MPa (with inspects the pressure gauge). If necessary add tap water into tank unit. Refer to tank unit installation instruction for details on how to add water.

2 Pressure relief valve

- Take out the cover with remove the mounting screw for access to the pressure relief valve.
- Move the lever into a horizontal position to open the valve.
- If you do not hear a clacking sound (due to water drainage), contact your local authorized dealer.
- Push the lever back down after you have finished the check.
- If the water continues to drain from the unit switch off the system and contact your local authorised dealer.
- Reinstall the cover with tighten the mounting screws properly, if the pressure relief valve is functioning normal.

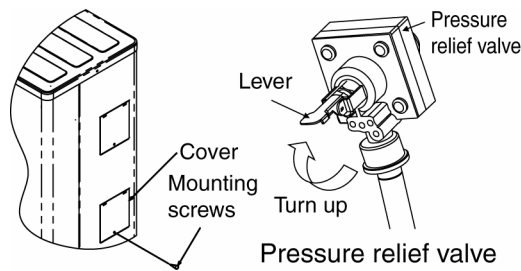

3 Air purge valve

Air purge valve must be installed at all high points in a closed water circuit system.

An automatic air purge valve is provided inside the indoor unit. To automatically purge the air from the system, turn the plug on the air outlet anticlockwise by one complete turn from fully closed position.

Excessive air is automatically purged if the plug is kept in this position.

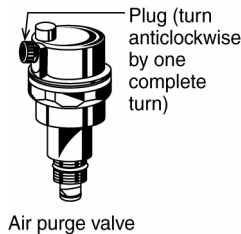

4 RCCB

Ensure the RCCB set to "ON" condition before check RCCB.

Turn on the power supply to the Mono bloc unit.

This testing could only be done when power is supplied to the Mono bloc unit.

WARNING

Be careful not to touch parts other than RCCB test button when the power is supplied to Mono bloc unit. Else, electrical shock may happen.

- Push the "TEST" button on the RCCB. The lever would turn down and indicate "0", if it functions normal.
- Contact authorized dealer if the RCCB malfunction.
- Turn off the power supply to the Mono bloc unit.
- If RCCB functions normal, set the lever to "ON" again after testing finish.

5 Reset overload protector

Overload Protector serves the safety purpose to prevent the water over heating. When the Overload Protector trip at high water temperature, take below steps to reset it.

- Take out OLP Cover.
- Use a test pen to push the centre button gently in order to reset the Overload protector.
- Fix the OLP Cover to the original fixing condition.

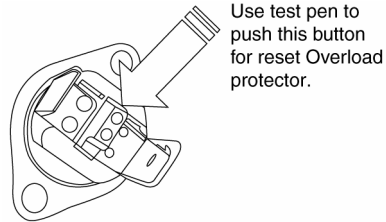

How to reset Overload protector

6 External water filter (field supply)

Clean the external water filter in regularly basic.

- External water filter is located inside the tube connector which is before water inlet connector of mono bloc unit (indicated with "WATER IN"). (Refer to figure below)
- Use spanner to detach the tube connector nut.
- Take out the filter carefully so that not deforms it shape.
- Use tap water only to wash the residue on the filter. If necessary, gently use soft brush only to clean the hard dirt.
- After clean, put it back to the original location and tighten the nut connection with torque wrench.

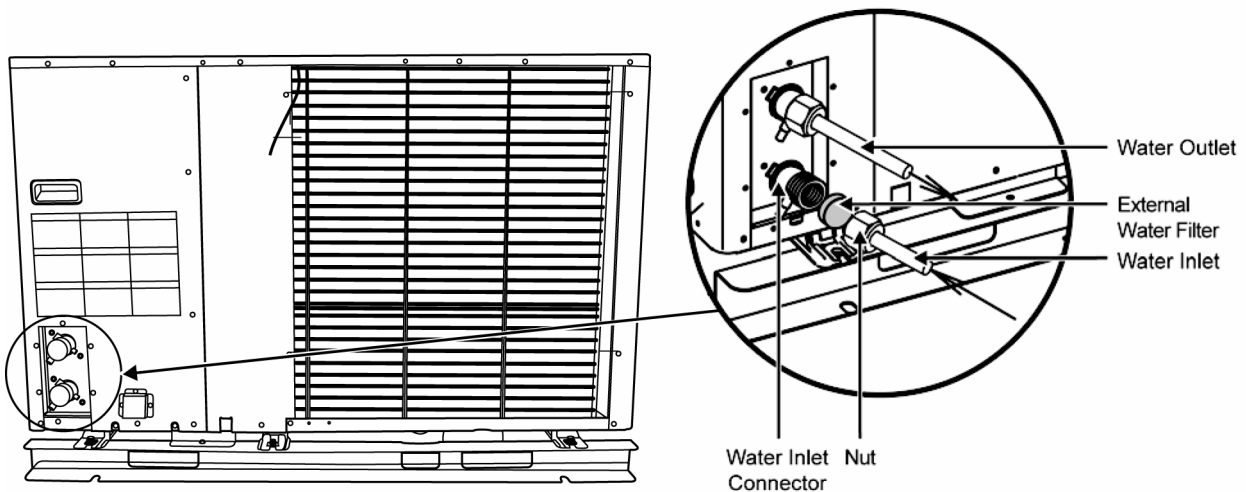

Location Of External Water Filter

16. Troubleshooting Guide

16.1 Refrigeration Cycle System

In order to diagnose malfunctions, make sure that there are no electrical problems before inspecting the refrigeration cycle.

Such problems include insufficient insulation, problem with the power source, malfunction of a compressor and a fan.

The normal pressure of the refrigeration cycle depends on various conditions, the standard values for them are shown in the table on the right.

Normal Pressure (Standard)

	Gas pressure MPa (kg/cm ² G)
Heating Mode	2.3 ~ 2.9 (23 ~ 29)

- ★ Condition:
- Outdoor temperature 7°C at heating mode.
 - Compressor operates at rated frequency.

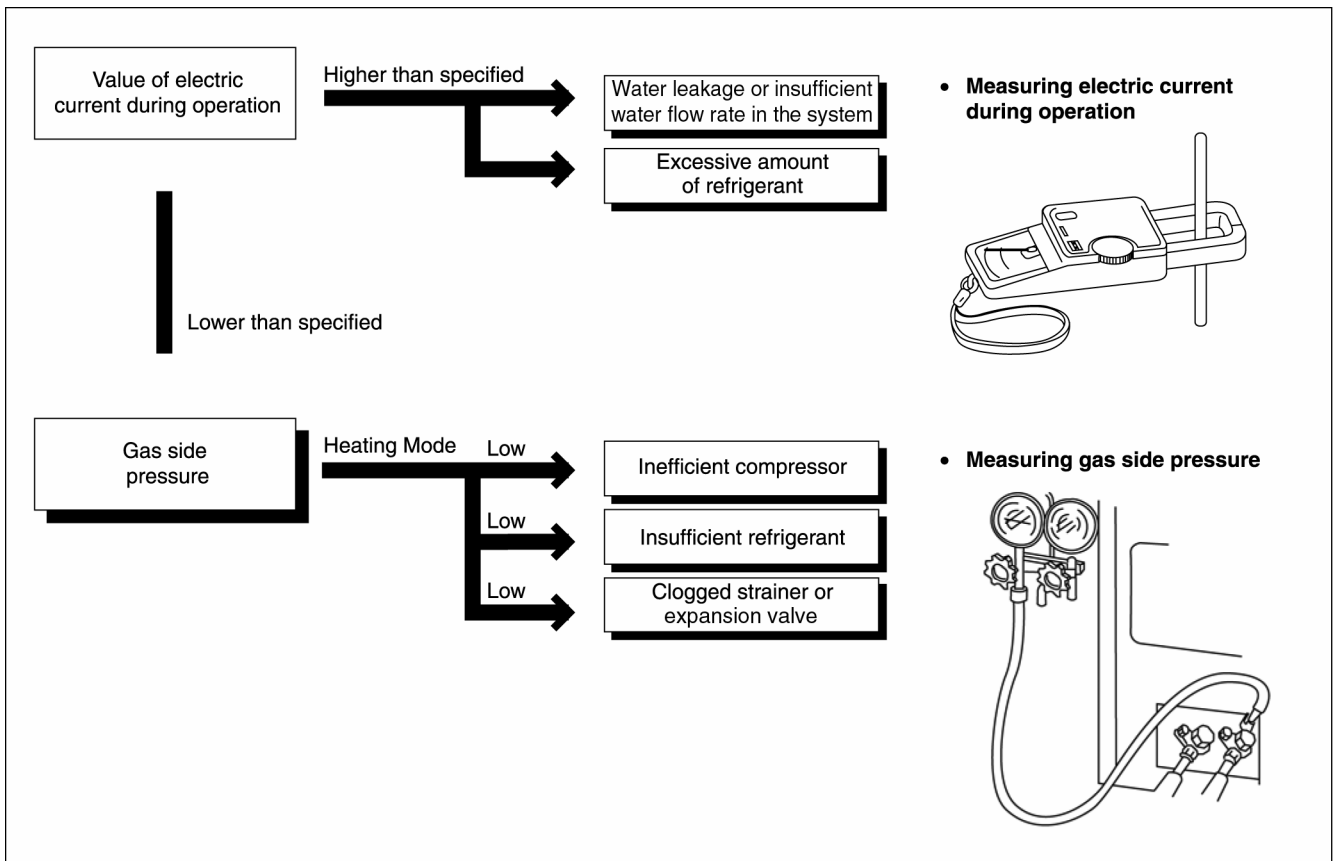



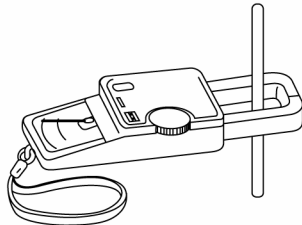



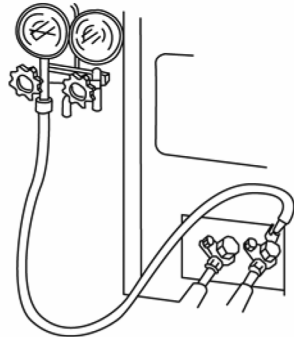











• Measuring electric current during operation



• Measuring gas side pressure



16.2 Relationship Between The Condition Of The Mono Bloc Unit And Pressure And Electric Current

Condition of the Mono bloc Unit	Heating Mode		
	Low Pressure	High Pressure	Electric current during operation
Water leakage or insufficient water flow rate in the system			
Excessive amount of refrigerant			
Inefficient compression			
Insufficient refrigerant (gas leakage)			
Mono bloc unit (refrigerant system) heat exchange deficiency			
Clogged expansion valve or Strainer			

- Carry out the measurements of pressure, electric current, and temperature fifteen minutes after an operation is started.

16.3 Breakdown Self Diagnosis Function

16.3.1 Self Diagnosis Function (Three Digits Alphanumeric Code)

- When abnormality occur during operation, the system will stop operation, and OFF/ON remote control LED will blink and error code will display on the remote control Timer display LCD.
- Even error code is reset by turning OFF power supply or by pressing ERROR RESET button, if the system abnormality is still un-repaired, system will again stop operation, and OFF/ON remote control LED will again blink.
- The error code will store in IC memory.
- **To check the error code**
 - 1 When an abnormality occurs, system will stop operation and OFF/ON remote control LED will blink.
 - 2 Error code of the abnormality will display on the remote control Timer display LCD.
 - 3 To determine the abnormality description, the Error Code Table needs to be referred.
- **To display past/last error code**
 - 1 Turn ON power supply.
 - 2 Press and hold the CHECK button for more than 5 seconds to enter status mode.
 - 3 Press the SEARCH DOWN/UP button to retrieve past/last error code.
 - 4 Press the CANCEL button or wait 30 seconds to exit status mode.
- **To permanently delete error code from IC memory**
 - 1 Turn ON power supply.
 - 2 Press and hold the ERROR RESET button for more than 8 seconds till a beep sound is heard.

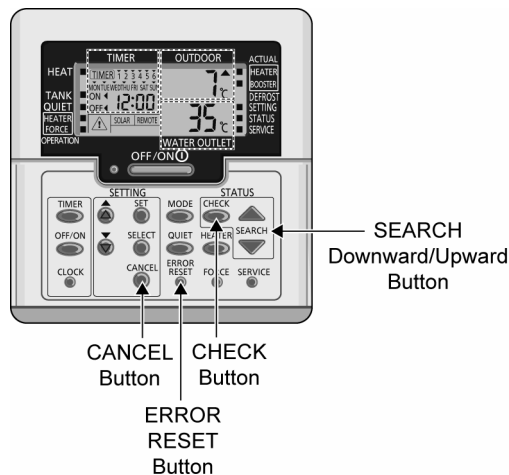

16.4 Error Codes Table

Diagnosis display	Abnormality/Protection control	Abnormality Judgement	Primary location to verify
H00	No abnormality detected	—	—
H12	Indoor/Outdoor capacity unmatched	90s after power supply	<ul style="list-style-type: none"> Indoor/outdoor connection wire Indoor/outdoor PCB Specification and combination table in catalogue
H15	Outdoor compressor temperature sensor abnormality	Continue for 5 sec.	<ul style="list-style-type: none"> Compressor temperature sensor (defective or disconnected)
H23	Indoor refrigerant liquid temperature sensor abnormality	Continue for 5 sec.	<ul style="list-style-type: none"> Refrigerant liquid temperature sensor (defective or disconnected)
H42	Compressor low pressure abnormality	—	<ul style="list-style-type: none"> Outdoor pipe temperature sensor Clogged expansion valve or strainer Insufficient refrigerant Outdoor PCB Compressor
H62	Water flow switch abnormality	Continue for 1 min.	<ul style="list-style-type: none"> Water flow switch
H63	Refrigerant low pressure abnormality	4 times occurrence within 20 minutes	<ul style="list-style-type: none"> Outdoor low pressure sensor (defective or disconnected)
H64	Refrigerant high pressure abnormality	Continue for 5 sec.	<ul style="list-style-type: none"> Outdoor high pressure sensor (defective or disconnected)
H70	Back-up heater OLP abnormality	Continue for 60 sec.	<ul style="list-style-type: none"> Back-up heater OLP (Disconnection or activated)
H72	Tank sensor abnormal	Continue for 5 sec.	<ul style="list-style-type: none"> Tank sensor
H76	Indoor - remote control communication abnormality	—	<ul style="list-style-type: none"> Indoor - control panel (defective or disconnected)
H90	Indoor/outdoor abnormal communication	> 1 min after starting operation	<ul style="list-style-type: none"> Internal/external cable connections Indoor/Outdoor PCB
H91	Tank heater OLP abnormality	Continue for 60 sec.	<ul style="list-style-type: none"> Tank heater OLP (Disconnection or activated)
H95	Indoor/Outdoor wrong connection	—	<ul style="list-style-type: none"> Indoor/Outdoor supply voltage
H98	Outdoor high pressure overload protection	—	<ul style="list-style-type: none"> Outdoor high pressure sensor Water pump or water leakage Clogged expansion valve or strainer Excess refrigerant Outdoor PCB
H99	Indoor heat exchanger freeze prevention	—	<ul style="list-style-type: none"> Indoor heat exchanger Refrigerant shortage
F12	Pressure switch activate	4 times occurrence within 20 minutes	<ul style="list-style-type: none"> Pressure switch
F14	Outdoor compressor abnormal revolution	4 times occurrence within 20 minutes	<ul style="list-style-type: none"> Outdoor compressor
F15	Outdoor fan motor lock abnormality	2 times occurrence within 30 minutes	<ul style="list-style-type: none"> Outdoor PCB Outdoor fan motor
F16	Total running current protection	3 times occurrence within 20 minutes	<ul style="list-style-type: none"> Excess refrigerant Outdoor PCB
F20	Outdoor compressor overheating protection	4 times occurrence within 30 minutes	<ul style="list-style-type: none"> Compressor tank temperature sensor Clogged expansion valve or strainer Insufficient refrigerant Outdoor PCB Compressor
F22	IPM (power transistor) overheating protection	3 times occurrence within 30 minutes	<ul style="list-style-type: none"> Improper heat exchange IPM (Power transistor)
F23	Outdoor Direct Current (DC) peak detection	7 times occurrence continuously	<ul style="list-style-type: none"> Outdoor PCB Compressor
F24	Refrigeration cycle abnormality	2 times occurrence within 20 minutes	<ul style="list-style-type: none"> Insufficient refrigerant Outdoor PCB Compressor low compression
F25	Cooling/Heating cycle changeover abnormality	4 times occurrence within 30 minutes	<ul style="list-style-type: none"> 4-way valve V-coil
F27	Pressure switch abnormality	Continue for 1 min.	<ul style="list-style-type: none"> Pressure switch
F36	Outdoor air temperature sensor abnormality	Continue for 5 sec.	<ul style="list-style-type: none"> Outdoor air temperature sensor (defective or disconnected)
F37	Indoor water inlet temperature sensor abnormality	Continue for 5 sec.	<ul style="list-style-type: none"> Water inlet temperature sensor (defective or disconnected)
F40	Outdoor discharge pipe temperature sensor abnormality	Continue for 5 sec.	<ul style="list-style-type: none"> Outdoor discharge pipe temperature sensor (defective or disconnected)
F41	PFC control	4 times occurrence within 10 minutes	<ul style="list-style-type: none"> Voltage at PFC

Diagnosis display	Abnormality/Protection control	Abnormality Judgement	Primary location to verify
F42	Outdoor heat exchanger temperature sensor abnormality	Continue for 5 sec.	<ul style="list-style-type: none"> Outdoor heat exchanger temperature sensor (defective or disconnected)
F43	Outdoor defrost sensor abnormality	Continue for 5 sec.	<ul style="list-style-type: none"> Outdoor defrost sensor (defective or disconnected)
F45	Indoor water outlet temperature sensor abnormality	Continue for 5 sec.	<ul style="list-style-type: none"> Water outlet temperature sensor (defective or disconnected)
F46	Outdoor Current Transformer open circuit	—	<ul style="list-style-type: none"> Insufficient refrigerant Outdoor PCB Compressor low
F48	Outdoor EVA outlet temperature sensor abnormality	Continue for 5 sec.	<ul style="list-style-type: none"> Outdoor EVA outlet temperature sensor (defective or disconnected)
F49	Outdoor bypass outlet temperature sensor abnormality	Continue for 5 sec.	<ul style="list-style-type: none"> Outdoor bypass outlet temperature sensor (defective or disconnected)
F95	Cooling high pressure overload protection	—	<ul style="list-style-type: none"> Outdoor high pressure sensor Water pump or water leakage Clogged expansion valve or strainer Excess refrigerant Outdoor PCB

16.5 Self-diagnosis Method

16.5.1 Connection Capability Rank Abnormality (H12)

Malfunction Decision Conditions:

During startup operation of heating, the capability rank of indoor checked by the outdoor is used to determine connection capability rank abnormality.

Malfunction Caused:

- 1 Wrong model interconnected.
- 2 Wrong indoor unit or outdoor unit PCB (main) used.
- 3 Faulty indoor unit or outdoor unit PCB (main).

Abnormality Judgment:

Continue for 90 seconds.

Troubleshooting:

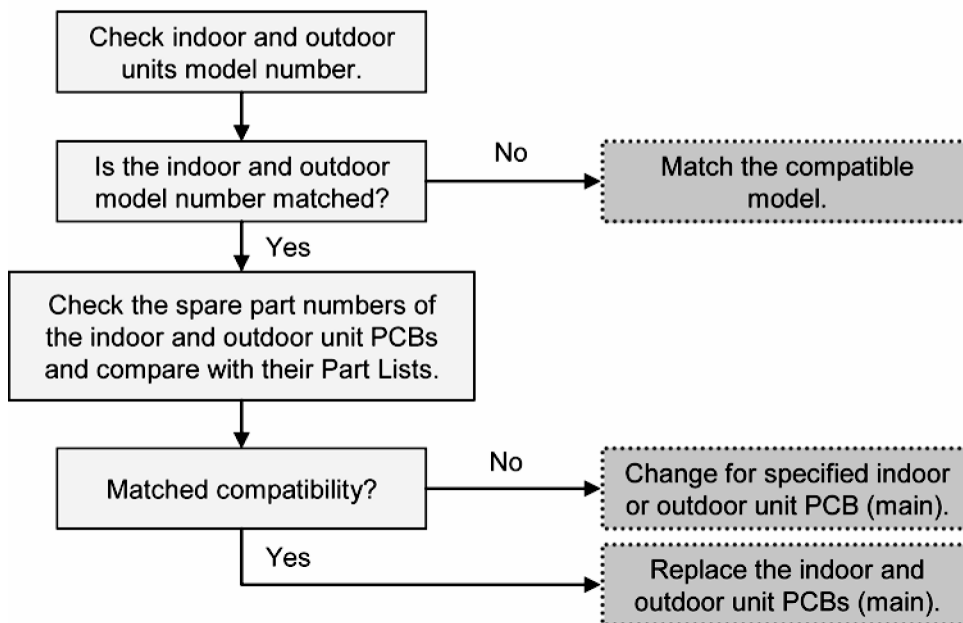

16.5.2 Compressor Tank Temperature Sensor Abnormality (H15)

Malfunction Decision Conditions:

During startup and operation of heating, the temperatures detected by the compressor tank temperature sensor are used to determine sensor error.

Malfunction Caused:

- 1 Faulty connector connection.
- 2 Faulty sensor.
- 3 Faulty outdoor unit PCB (main).

Abnormality Judgment:

Continue for 5 seconds.

Troubleshooting:

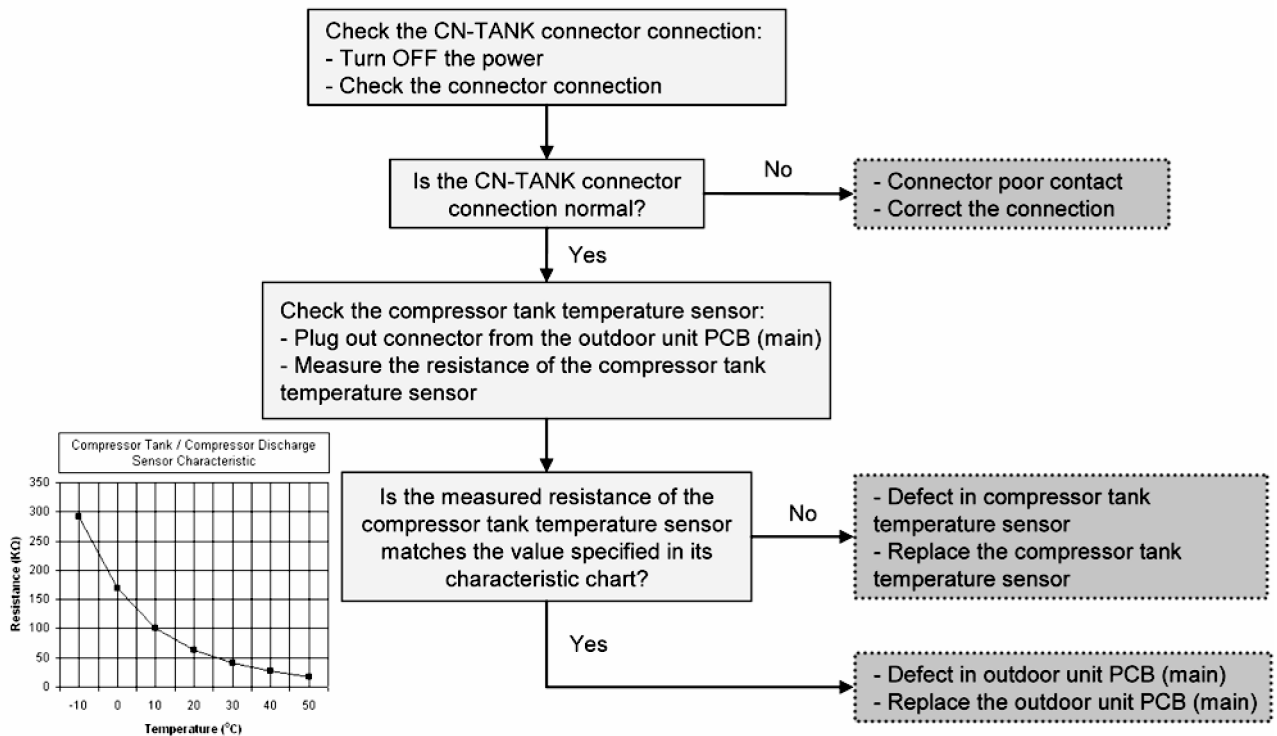

16.5.3 Indoor Refrigerant Liquid Temperature Sensor Abnormality (H23)

Malfunction Decision Conditions:

During startup and operation of heating, the temperatures detected by the indoor refrigerant liquid temperature sensor are used to determine sensor error.

Malfunction Caused:

- 1 Faulty connector connection.
- 2 Faulty sensor.
- 3 Faulty indoor unit PCB (main).

Abnormality Judgment:

Continue for 5 seconds.

Troubleshooting:



For safety reason and to prevent component breakdown, always switch off the power before remove and connect the component.

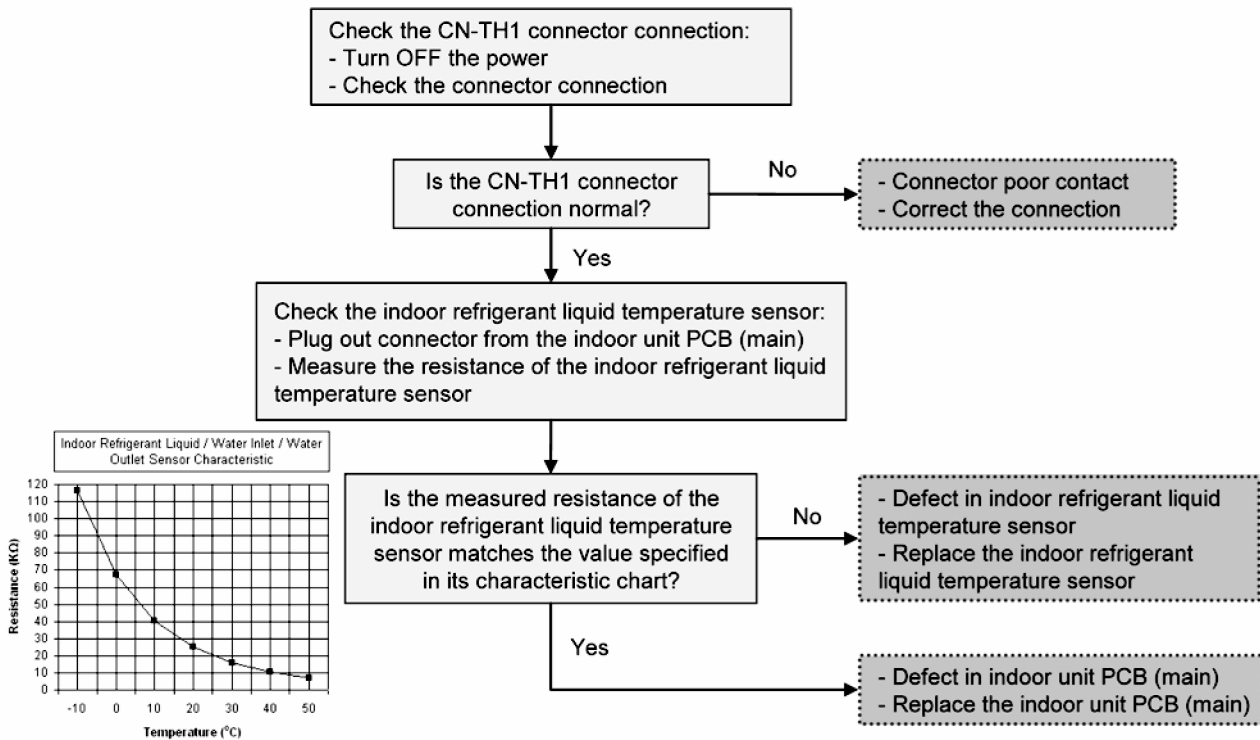

16.5.4 Compressor Low Pressure Protection (H42)

Malfunction Decision Conditions:

During operation of heating and after 5 minutes compressor ON, when outdoor pipe temperature below -29°C or above 26°C is detected by the outdoor pipe temperature sensor.

Malfunction Caused:

- 1 Dust accumulation on the outdoor unit heat exchanger.
- 2 Air short circuit at outdoor unit.
- 3 2 way valve partially closed.
- 4 Faulty outdoor unit fan motor.
- 5 Refrigerant shortage (refrigerant leakage).
- 6 Clogged expansion valve or strainer.
- 7 Faulty outdoor pipe temperature sensor.
- 8 Faulty outdoor unit main PCB (main).

Troubleshooting:



Caution

For safety reason and to prevent component breakdown, always switch off the power before remove and connect the component.

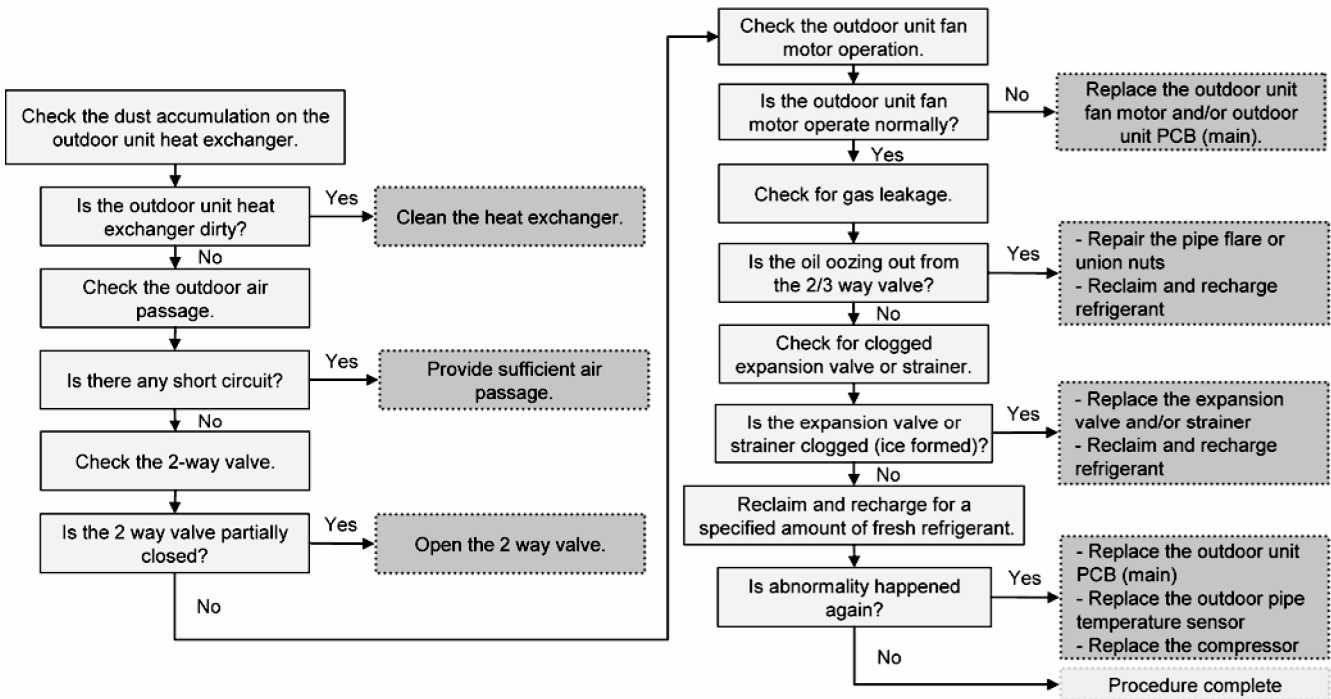

16.5.5 Water Flow Switch Abnormality (H62)

Malfunction Decision Conditions:

During operation of heating, the water flow detected by the indoor water flow switch is used to determine water flow error.

Malfunction Caused:

- 1 Faulty water pump.
- 2 Water leak in system.
- 3 Faulty connector connection.
- 4 Faulty water flow switch.
- 5 Faulty indoor unit PCB (main).

Abnormality Judgment:

Continue for 10 seconds (but no judgment for 9 minutes after compressor startup/restart).

Troubleshooting:



Caution

For safety reason and to prevent component breakdown, always switch off the power before remove and connect the component.

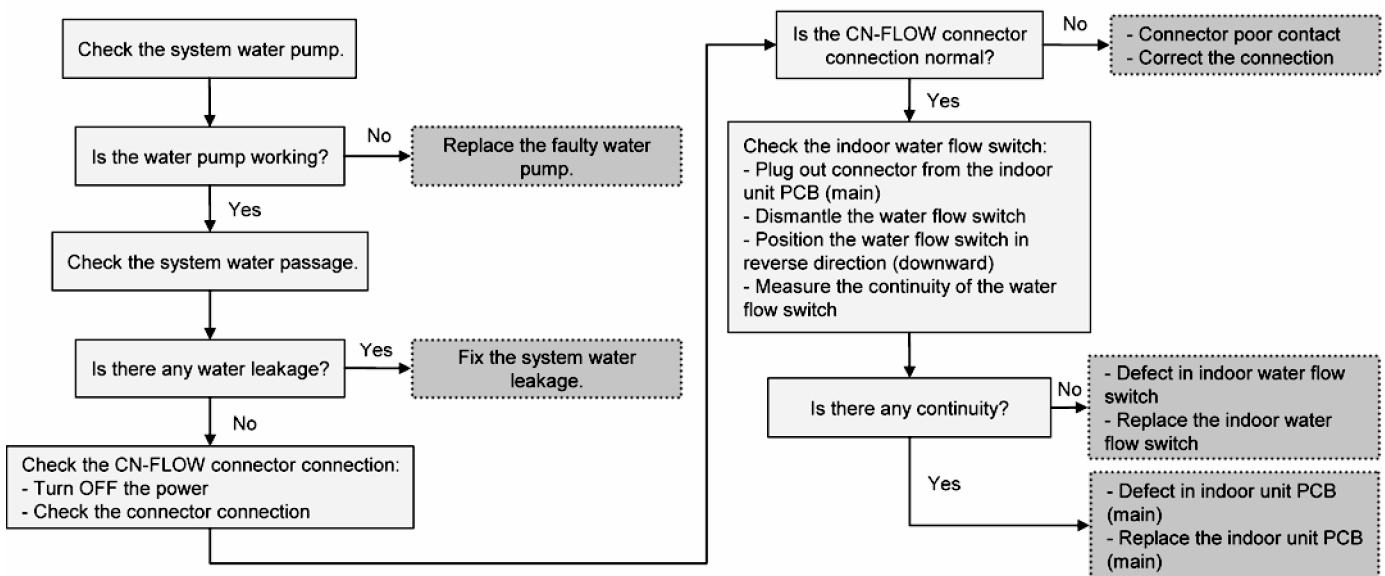

16.5.6 Outdoor Low Pressure Abnormality (H63)

Malfunction Decision Conditions:

During operation of heating, when the outdoor low pressure sensor output signal is 0Vdc or 5Vdc.

Malfunction Caused:

- 1 Faulty connector connection.
- 2 Faulty sensor.
- 3 Faulty outdoor unit PCB (main).

Abnormality Judgment:

Continue 4 times in 20 minutes.

Troubleshooting:



Caution

For safety reason and to prevent component breakdown, always switch off the power before remove and connect the component.

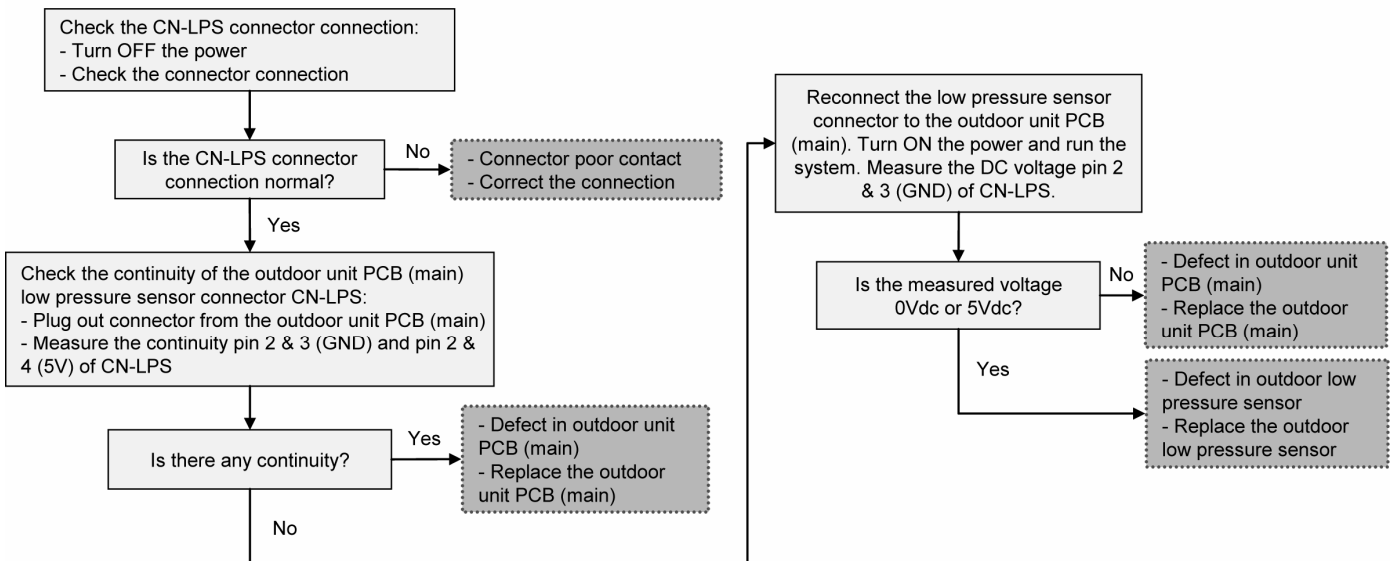

16.5.7 Outdoor High Pressure Abnormality (H64)

Malfunction Decision Conditions:

During operation of heating, when the outdoor high pressure sensor output signal is 0Vdc or 5Vdc.

Malfunction Caused:

- 1 Faulty connector connection.
- 2 Faulty sensor.
- 3 Faulty outdoor unit PCB (main).

Abnormality Judgment:

Continue 4 times in 20 minutes.

Troubleshooting:



Caution

For safety reason and to prevent component breakdown, always switch off the power before remove and connect the component.

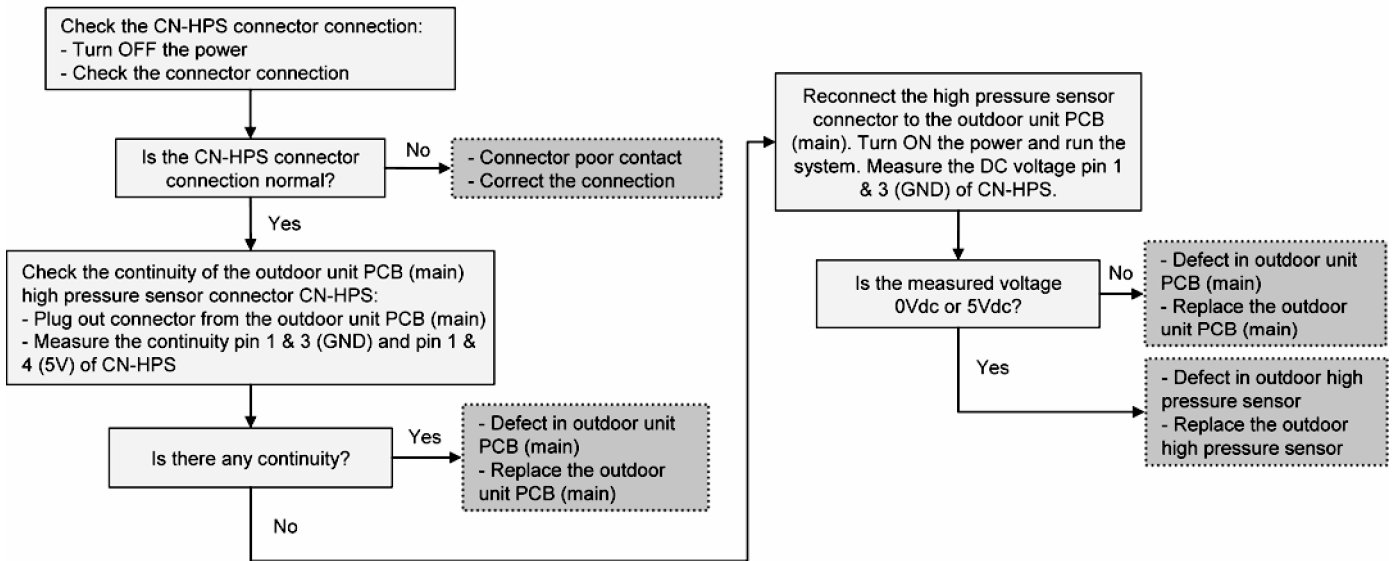

16.5.8 Indoor Backup Heater OLP Abnormality (H70)

Malfunction Decision Conditions:

During operation of indoor backup heater, when no power supplies to indoor backup heater or OLP open circuit.

Malfunction Caused:

- 1 Faulty power supply connector connection.
- 2 Faulty connector connection.
- 3 Faulty indoor backup heater overload protector (OLP).
- 4 Faulty indoor unit PCB (main).

Abnormality Judgment:

Continue for 60 seconds.

Troubleshooting:



Caution

For safety reason and to prevent component breakdown, always switch off the power before remove and connect the component.

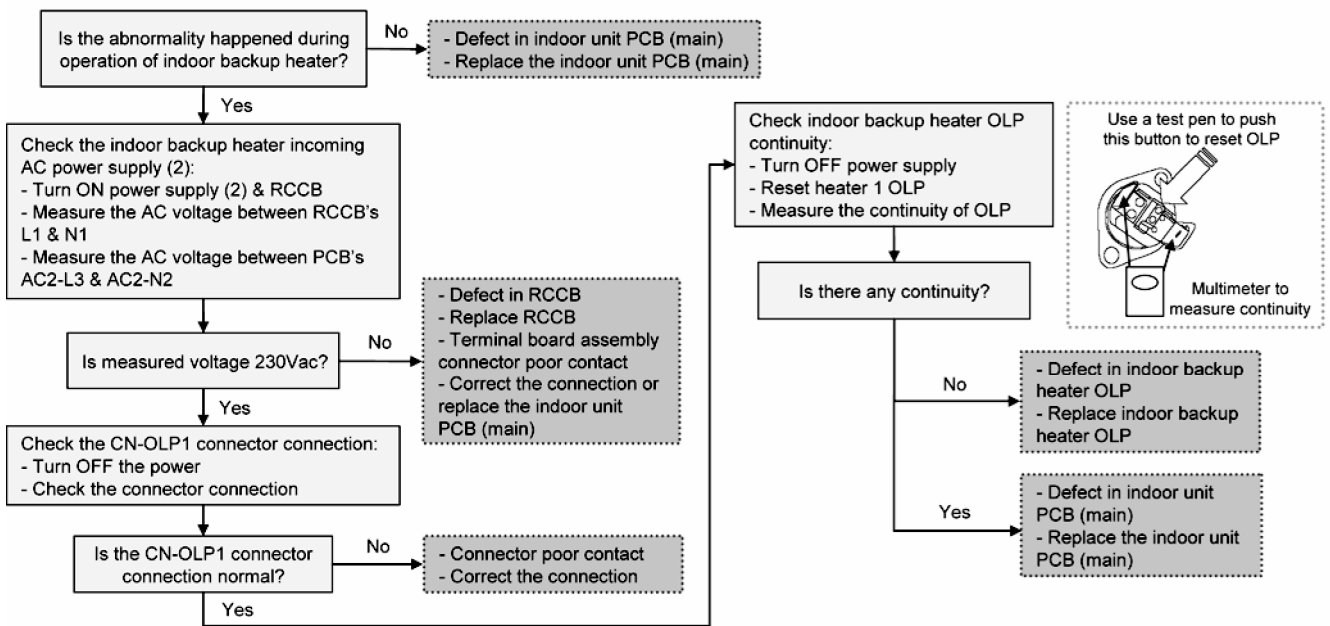

16.5.9 Tank Temperature Sensor Abnormality (H72)

Malfunction Decision Conditions:

When tank connection is set to ON, the temperatures detected by the tank temperature sensor are used to determine sensor error.

Malfunction Caused:

- 1 Faulty connector connection.
- 2 Faulty sensor.
- 3 Faulty indoor unit PCB (main).

Abnormality Judgment:

Continue for 5 seconds.

Troubleshooting:



Caution

For safety reason and to prevent component breakdown, always switch off the power before remove and connect the component.

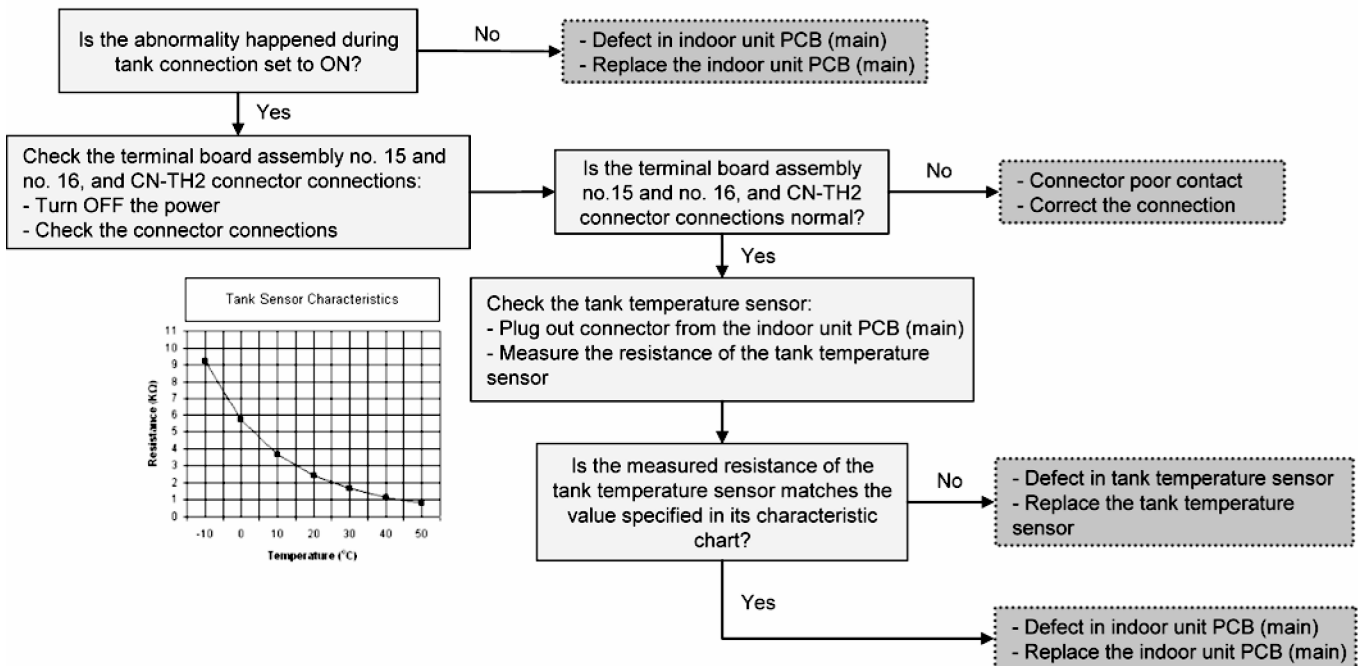

16.5.10 Indoor-Control Panel Communication Abnormality (H76)

Malfunction Decision Conditions:

During standby and operation of heating, indoor-remote control error occur.

Malfunction Caused:

- 1 Faulty connector connection.
- 2 Faulty remote control.
- 3 Faulty indoor unit PCB (main).

Troubleshooting:



Caution

For safety reason and to prevent component breakdown, always switch off the power before remove and connect the component.

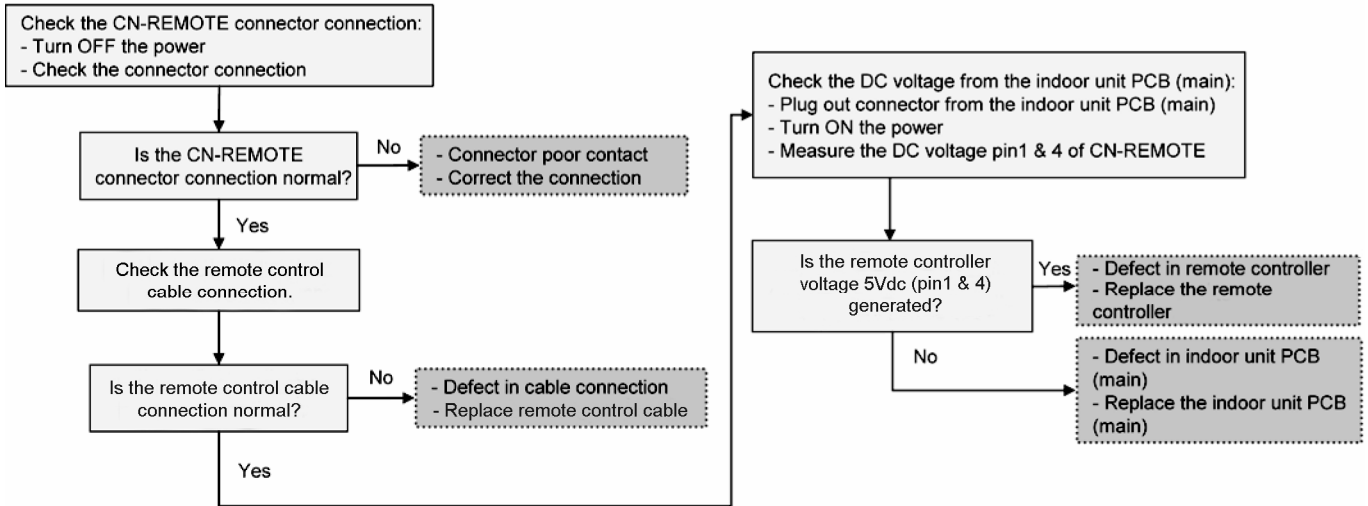

16.5.11 Indoor/Outdoor Abnormal Communication (H90)

Malfunction Decision Conditions:

During operation of heating, the data received from outdoor unit in indoor unit signal transmission is checked whether it is normal.

Malfunction Caused:

- 1 Faulty outdoor unit PCB (main).
- 2 Faulty indoor unit PCB (main).
- 3 Indoor-outdoor signal transmission error due to wrong wiring.
- 4 Indoor-outdoor signal transmission error due to breaking of wire in the connection wires between the indoor and outdoor units.
- 5 Indoor-outdoor signal transmission error due to disturbed power supply waveform.

Abnormality Judgment:

Continue for 1 minute after operation.

Troubleshooting:



For safety reason and to prevent component breakdown, always switch off the power before remove and connect the component.

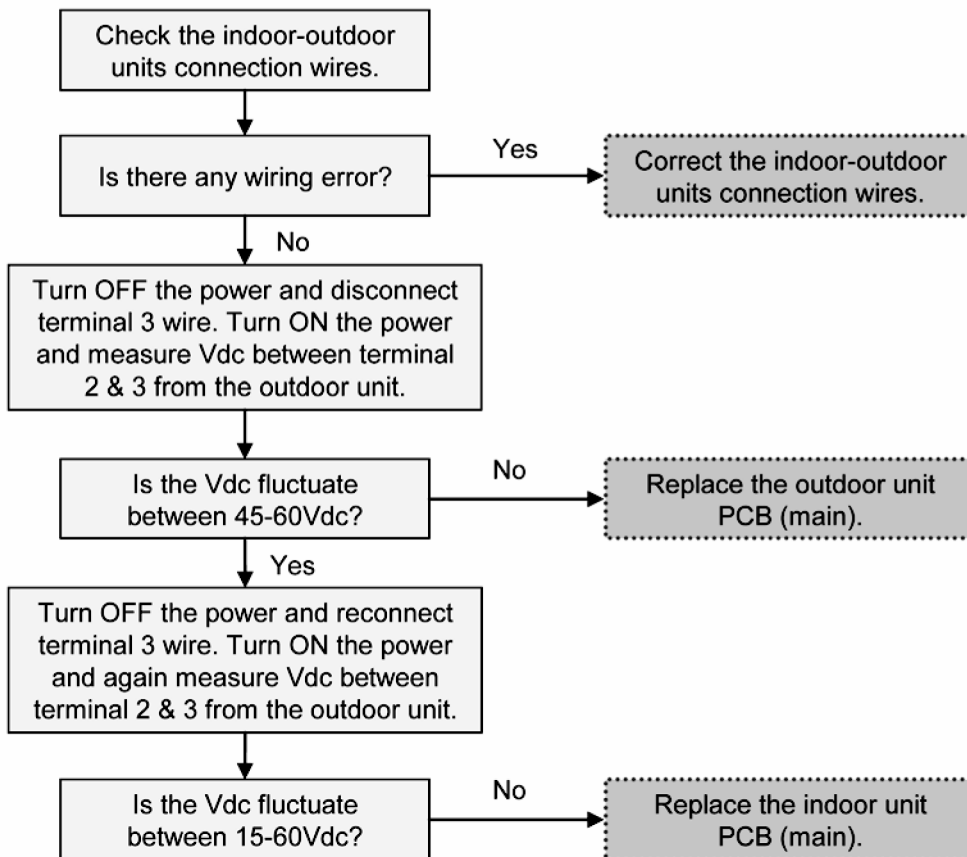

16.5.12 Tank Booster Heater OLP Abnormality (H91)

Malfunction Decision Conditions:

During operation of tank booster heater, and tank booster heater OLP open circuit.

Malfunction Caused:

- 1 Faulty connector connection.
- 2 Faulty tank booster heater overload protector (OLP).
- 3 Faulty indoor unit PCB (main).

Abnormality Judgment:

Continue for 60 seconds.

Troubleshooting:



Caution

For safety reason and to prevent component breakdown, always switch off the power before remove and connect the component.

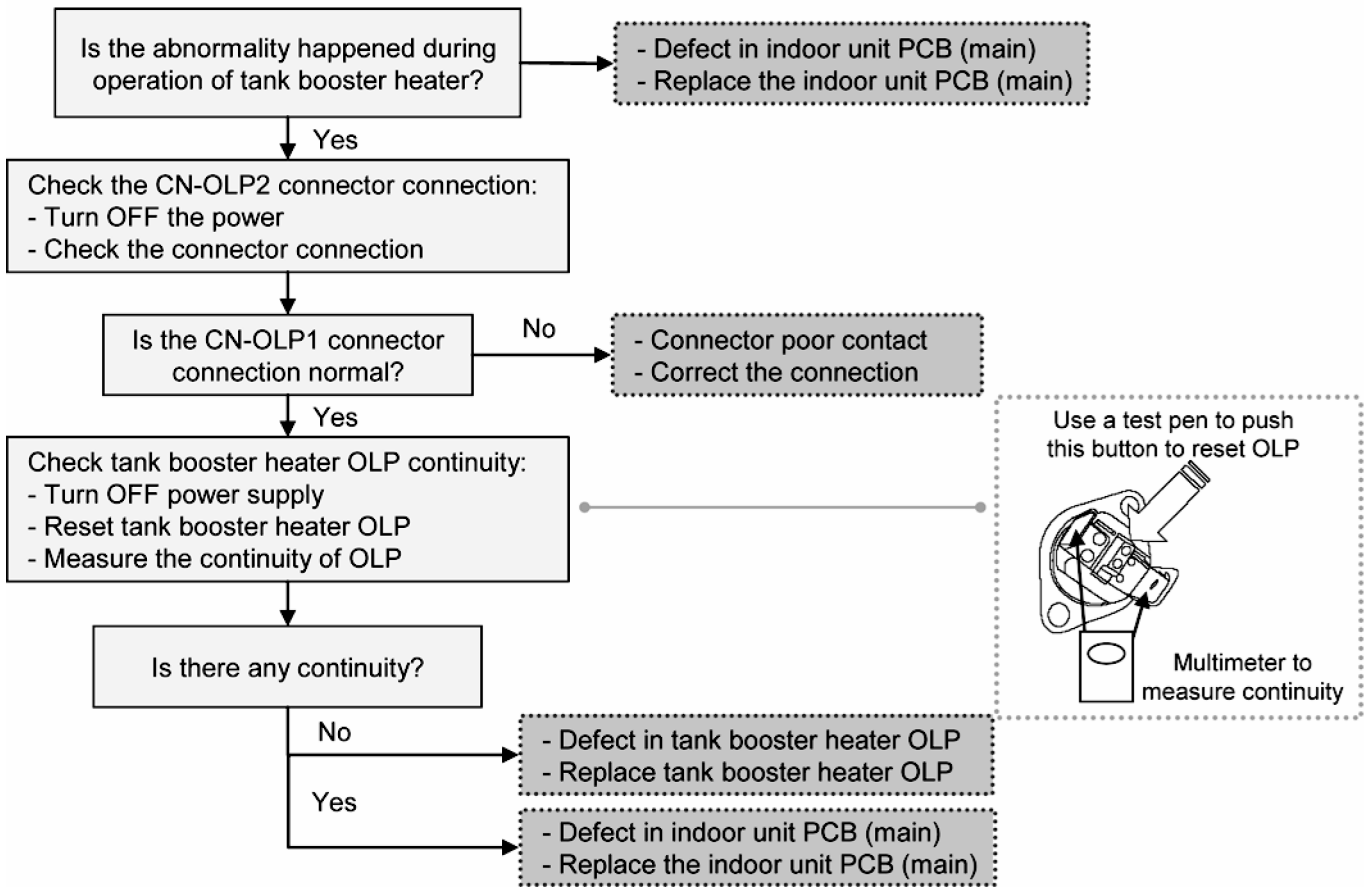

16.5.13 Unspecified Voltage between Indoor and Outdoor (H95)

Malfunction Decision Conditions:

The supply power is detected for its requirement by the indoor/outdoor transmission.

Malfunction Caused:

- 1 Insufficient power supply.
- 2 Faulty outdoor unit PCB (noise filter/main).

Troubleshooting:



For safety reason and to prevent component breakdown, always switch off the power before remove and connect the component.

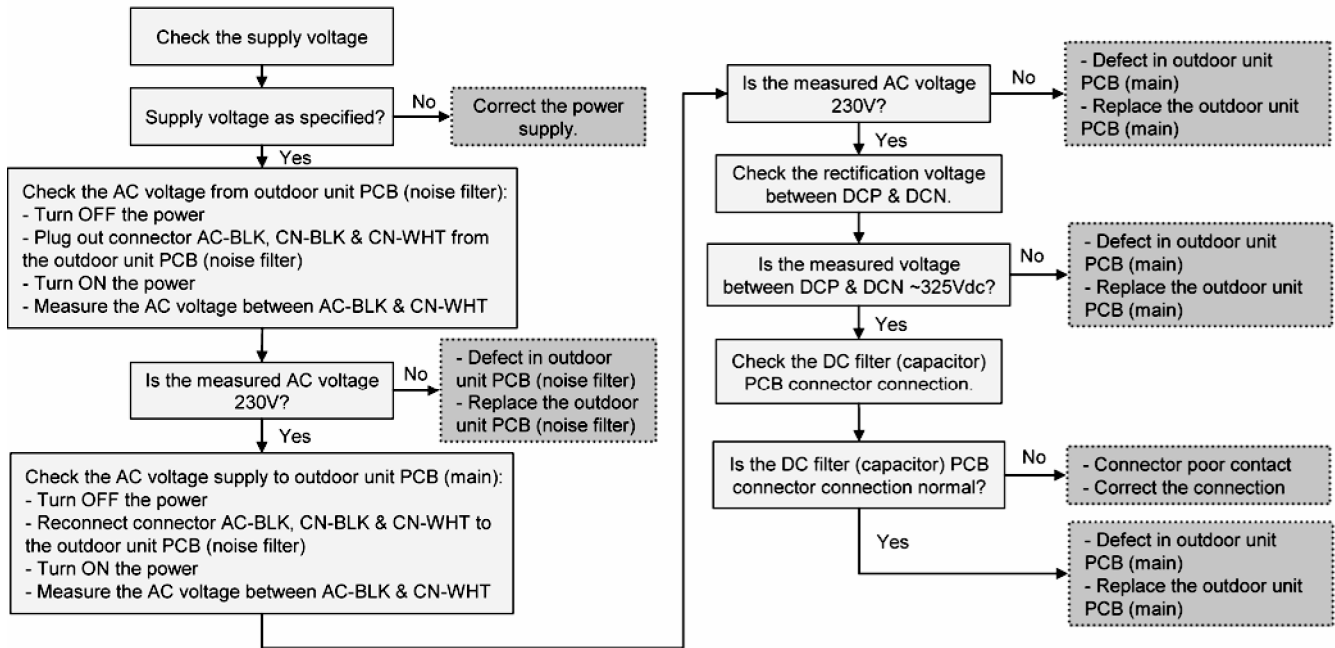

16.5.14 Outdoor High Pressure Protection (H98)

Malfunction Decision Conditions:

During operation of heating, when pressure 4.0 MPa and above is detected by outdoor high pressure sensor.

Malfunction Caused:

- 1 Faulty water pump.
- 2 Insufficient water flow rate in system.
- 3 Water leak in system.
- 4 2/3 way closed.
- 5 Clogged expansion valve or strainer.
- 6 Excessive refrigerant.
- 7 Faulty outdoor high pressure sensor.
- 8 Faulty outdoor unit PCB (main).

Troubleshooting:



Caution

For safety reason and to prevent component breakdown, always switch off the power before remove and connect the component.

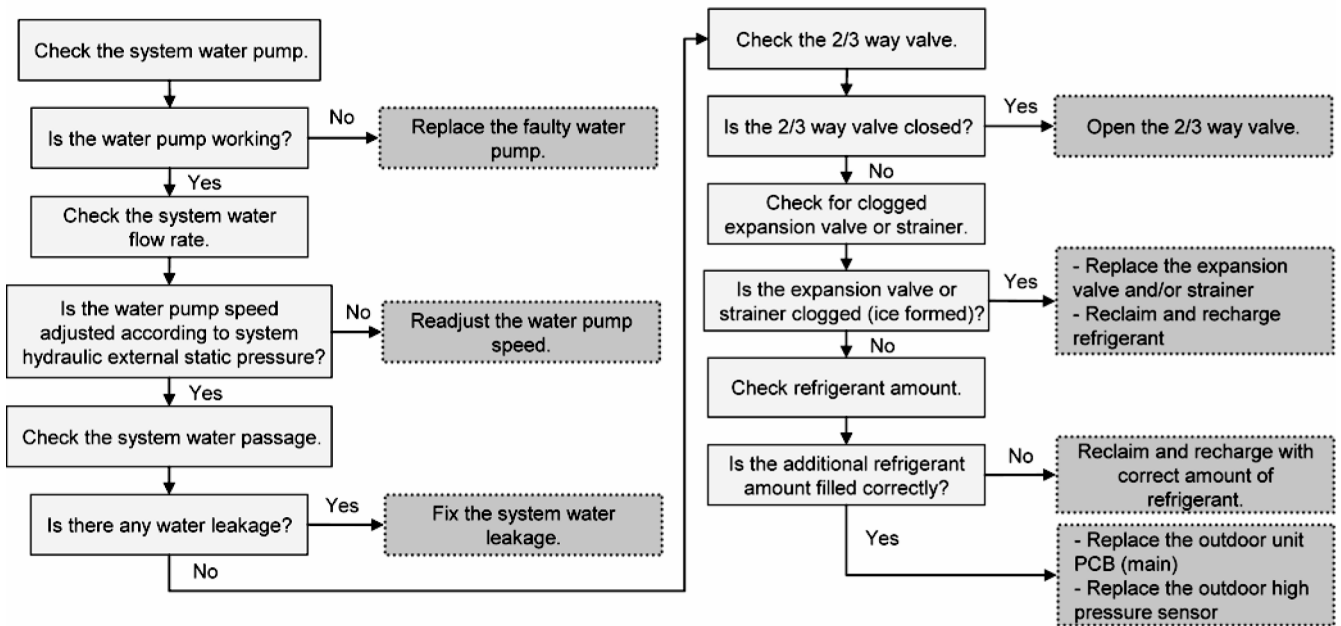

16.5.15 Indoor Freeze-up Protection (H99)

Malfunction Decision Conditions:

During anti-freezing control in cooling operation, when the indoor refrigerant liquid temperature $< 0^{\circ}\text{C}$.

Malfunction Caused:

- 1 Faulty water pump.
- 2 Insufficient water flow rate in system.
- 3 Water leak in system.
- 4 2 way valve partially closed.
- 5 Clogged expansion valve or strainer.
- 6 Refrigerant shortage (refrigerant leakage).
- 7 Faulty indoor refrigerant liquid temperature sensor.
- 8 Faulty indoor unit PCB (main).

Troubleshooting:



Caution

For safety reason and to prevent component breakdown, always switch off the power before remove and connect the component.

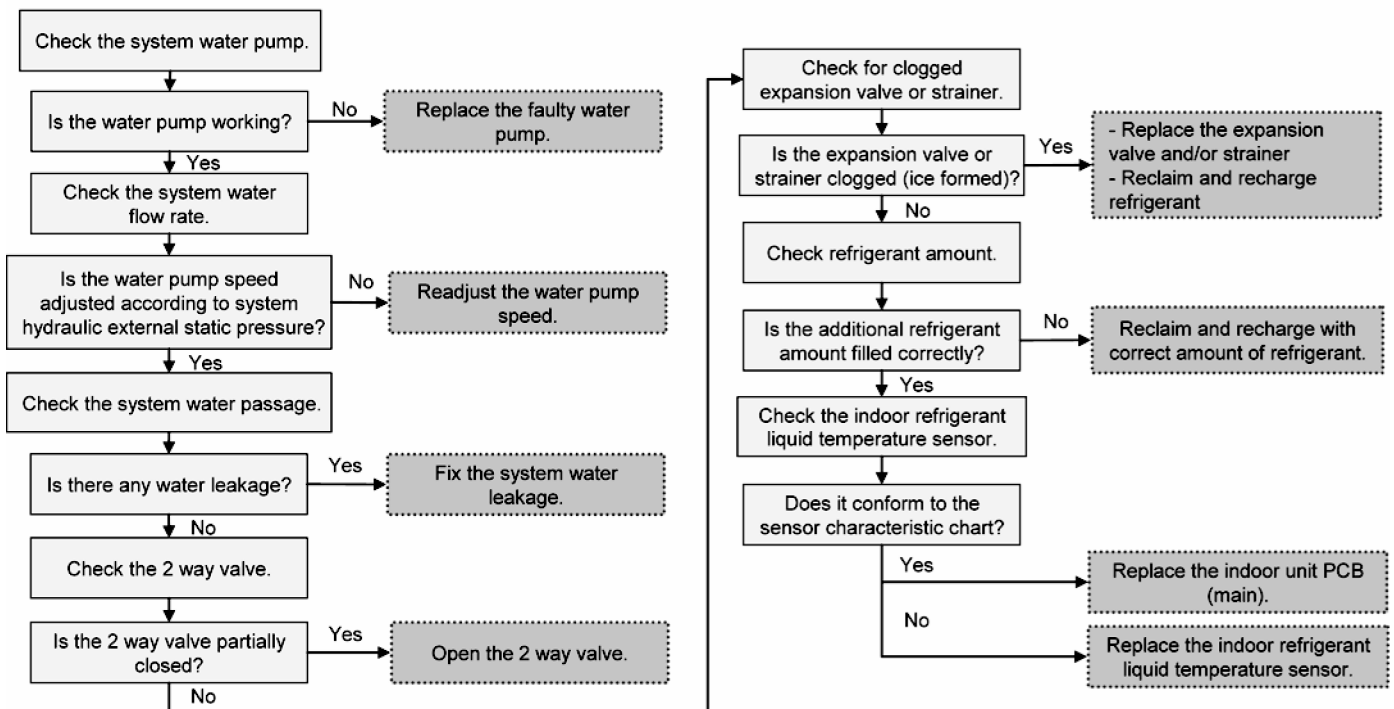

16.5.16 Outdoor High Pressure Switch Activate (F12)

Malfunction Decision Conditions:

During operation of heating, when pressure 4.5MPa and above is detected by outdoor high pressure switch.

Malfunction Caused:

- 1 Dust accumulation on the outdoor unit heat exchanger.
- 2 Air short circuit at outdoor unit.
- 3 Faulty water pump.
- 4 Insufficient water flow rate in system.
- 5 Water leak in system.
- 6 2/3 way valve closed.
- 7 Clogged expansion valve or strainer.
- 8 Excessive refrigerant.
- 9 Faulty outdoor high pressure sensor and switch.
- 10 Faulty outdoor unit PCB.

Abnormality Judgment:

Continue 4 times in 20 minutes.

Troubleshooting:



Caution

For safety reason and to prevent component breakdown, always switch off the power before remove and connect the component.

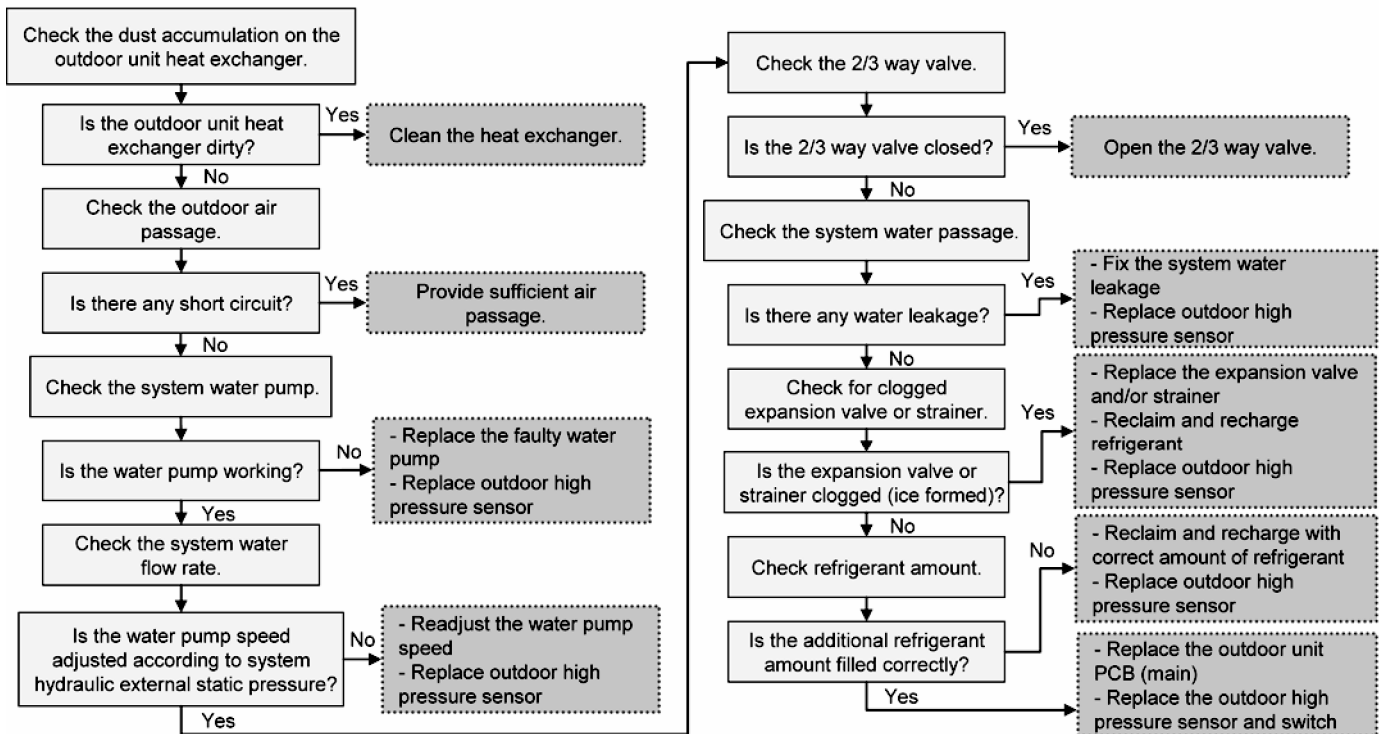

16.5.17 Compressor Rotation Failure (F14)

Malfunction Decision Conditions:

A compressor rotation failure is detected by checking the compressor running condition through the position detection circuit.

Malfunction Caused:

- 1 Compressor terminal disconnect.
- 2 Faulty outdoor unit PCB (main).
- 3 Faulty compressor.

Abnormality Judgment:

Continue 4 times in 20 minutes.

Troubleshooting:



Caution

For safety reason and to prevent component breakdown, always switch off the power before remove and connect the component.

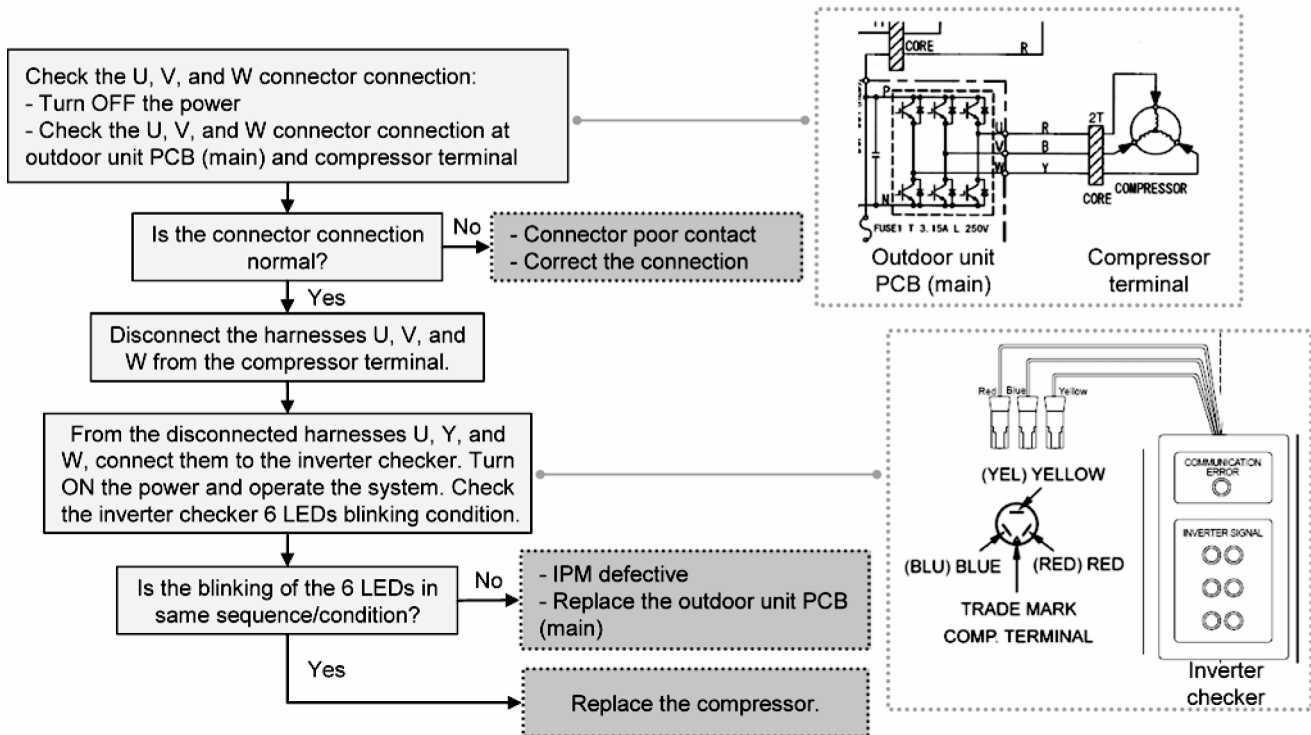

16.5.18 Outdoor Fan Motor (DC Motor) Mechanism Locked (F15)

Malfunction Decision Conditions:

The rotation speed detected by the Hall IC of the fan motor during fan motor operation is used to determine abnormal fan motor (feedback of rotation > 2550rpm or < 50rpm).

Malfunction Caused:

- 1 Operation stop due to short circuit inside the fan motor winding.
- 2 Operation stop due to breaking of wire inside the fan motor.
- 3 Operation stop due to breaking of fan motor lead wires.
- 4 Operation stop due to fan motor Hall IC malfunction.
- 5 Operation error due to faulty outdoor unit PCB.

Abnormality Judgment:

Continue 2 times in 30 minutes.

Troubleshooting:



Caution

For safety reason and to prevent component breakdown, always switch off the power before remove and connect the component.

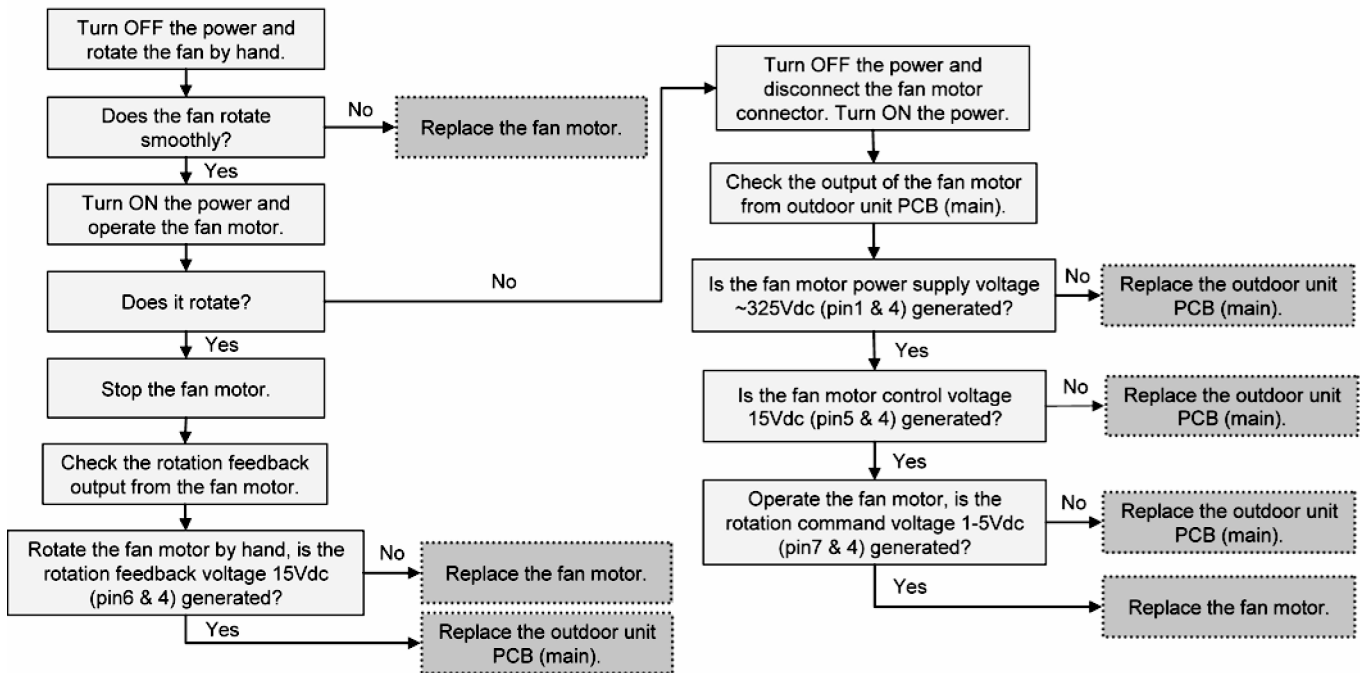

16.5.19 Input Over Current Detection (F16)

Malfunction Decision Conditions:

During operation of heating, when outdoor current above 27.9A is detected by the current transformer (CT) in the outdoor unit PCB.

Malfunction Caused:

- 1 Excessive refrigerant.
- 2 Faulty outdoor unit PCB (main).

Abnormality Judgment:

Continue 3 times in 20 minutes.

Troubleshooting:



For safety reason and to prevent component breakdown, always switch off the power before remove and connect the component.

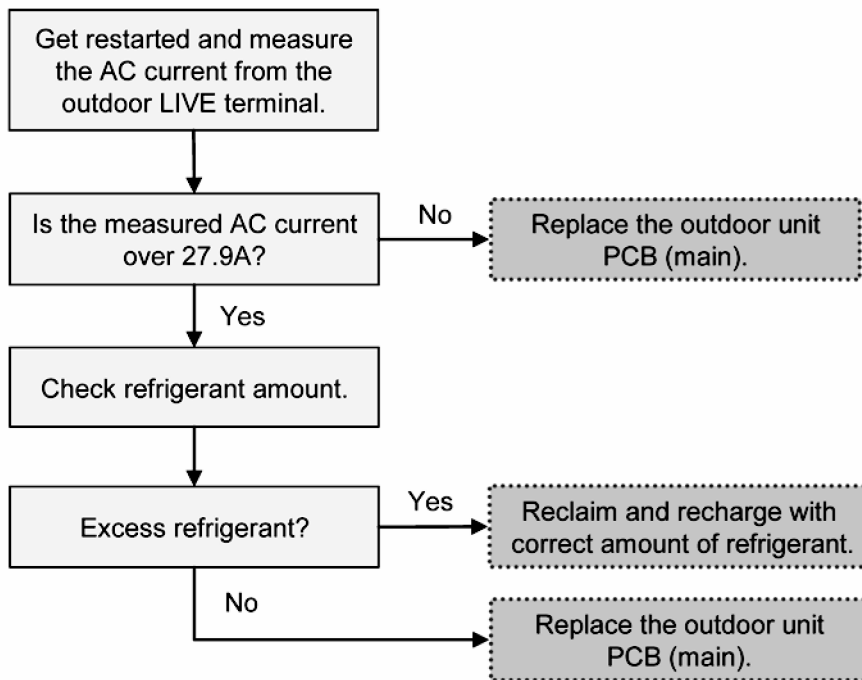

16.5.20 Compressor Overheating (F20)

Malfunction Decision Conditions:

During operation of heating, when temperature above 112°C is detected by the compressor tank temperature sensor.

Malfunction Caused:

- 1 Faulty compressor tank temperature sensor.
- 2 2/3 way valve closed.
- 3 Refrigerant shortage (refrigerant leakage).
- 4 Clogged expansion valve or strainer.
- 5 Faulty outdoor unit PCB (main).
- 6 Faulty compressor.

Abnormality Judgment:

Continue 4 times in 30 minutes.

Troubleshooting:



Caution

For safety reason and to prevent component breakdown, always switch off the power before remove and connect the component.

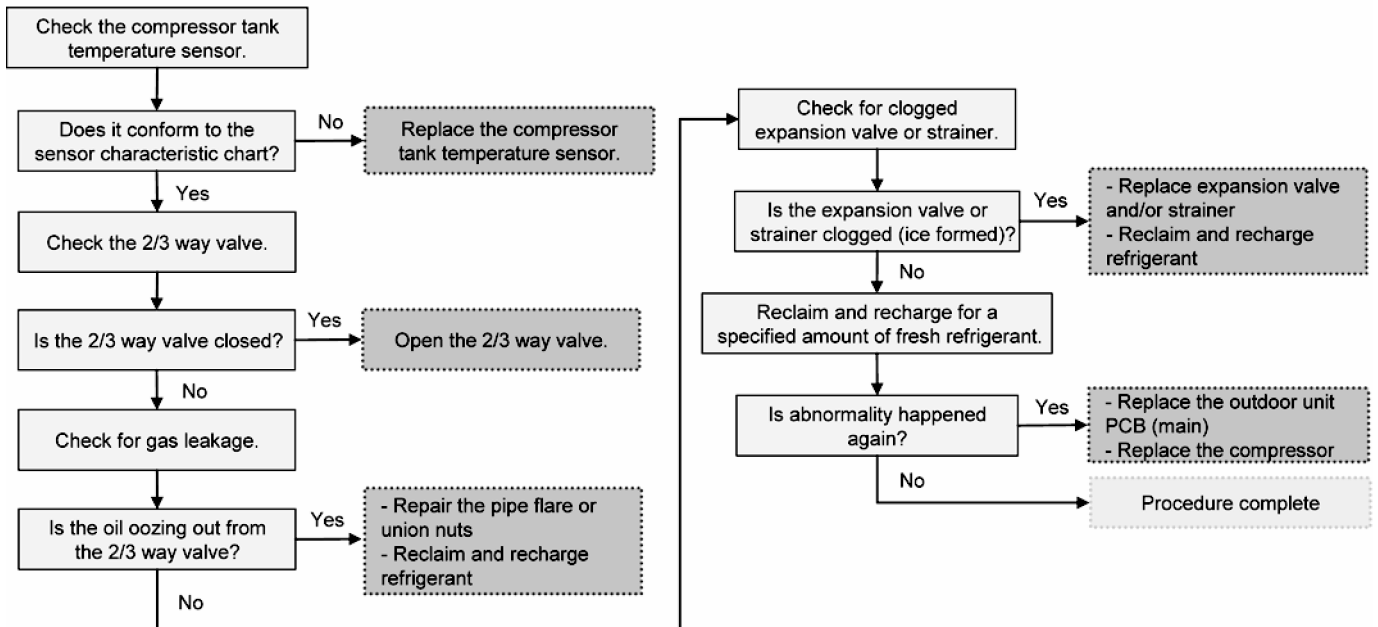

16.5.21 IPM Overheating (F22)

Malfunction Decision Conditions:

During operation of heating, when temperature 95°C is detected by the outdoor IPM temperature sensor.

Malfunction Caused:

- 1 Faulty outdoor unit fan motor.
- 2 Faulty outdoor unit PCB (main).

Abnormality Judgment:

Continue 3 times in 30 minutes.

Troubleshooting:



Caution

For safety reason and to prevent component breakdown, always switch off the power before remove and connect the component.

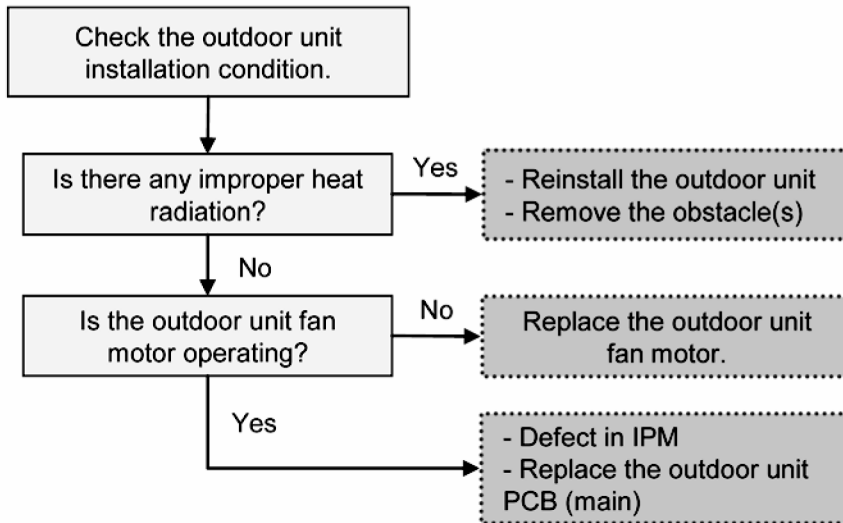

16.5.22 Output Over Current Detection (F23)

Malfunction Decision Conditions:

During operation of heating, when outdoor DC current is above $40.1 \pm 5.0A$ (for: UD07~09CE) OR $44.7 \pm 5.0A$ (for: UD12~16CE) is detected by the IPM DC Peak sensing circuitry in the outdoor unit PCB (main).

Malfunction Caused:

- 1 Faulty outdoor unit PCB (main).
- 2 Faulty compressor.

Abnormality Judgment:

Continue for 7 times.

Troubleshooting:



Caution

For safety reason and to prevent component breakdown, always switch off the power before remove and connect the component.

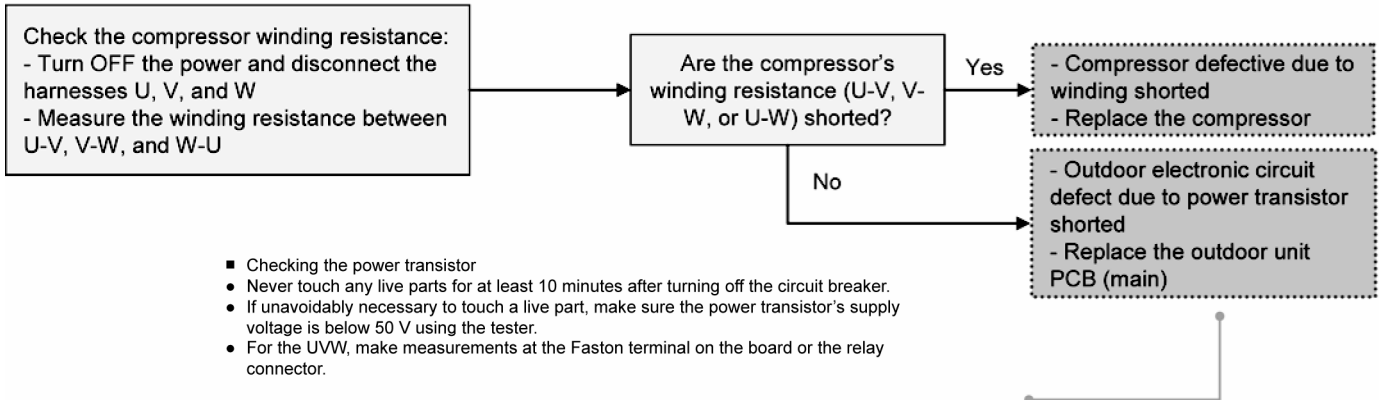

Tester's negative terminal	Power transistor (+)	UVW	Power transistor (-)	UVW
Tester's positive terminal	UVW	Power transistor (+)	UVW	Power transistor (-)
Normal resistance	Several kohms to several Mohms			
Abnormal resistance	0 or ∞			

16.5.23 Refrigeration Cycle Abnormality (F24)

Malfunction Decision Conditions:

- 1 During operation of heating, compressor frequency > Frated.
- 2 During operation of heating, running current: $0.65A < I < 1.65A$.
- 3 During operation of heating, indoor refrigerant liquid temperature - water inlet temperature < $5^{\circ}C$.

Malfunction Caused:

- 1 Faulty water inlet or indoor refrigerant liquid temperature sensors.
- 2 2/3 way valve closed.
- 3 Refrigerant shortage (refrigerant leakage).
- 4 Clogged expansion valve or strainer.
- 5 Faulty outdoor unit PCB (main).
- 6 Poor compression of compressor.

Abnormality Judgment:

Continue 2 times in 20 minutes.

Troubleshooting:



Caution

For safety reason and to prevent component breakdown, always switch off the power before remove and connect the component.

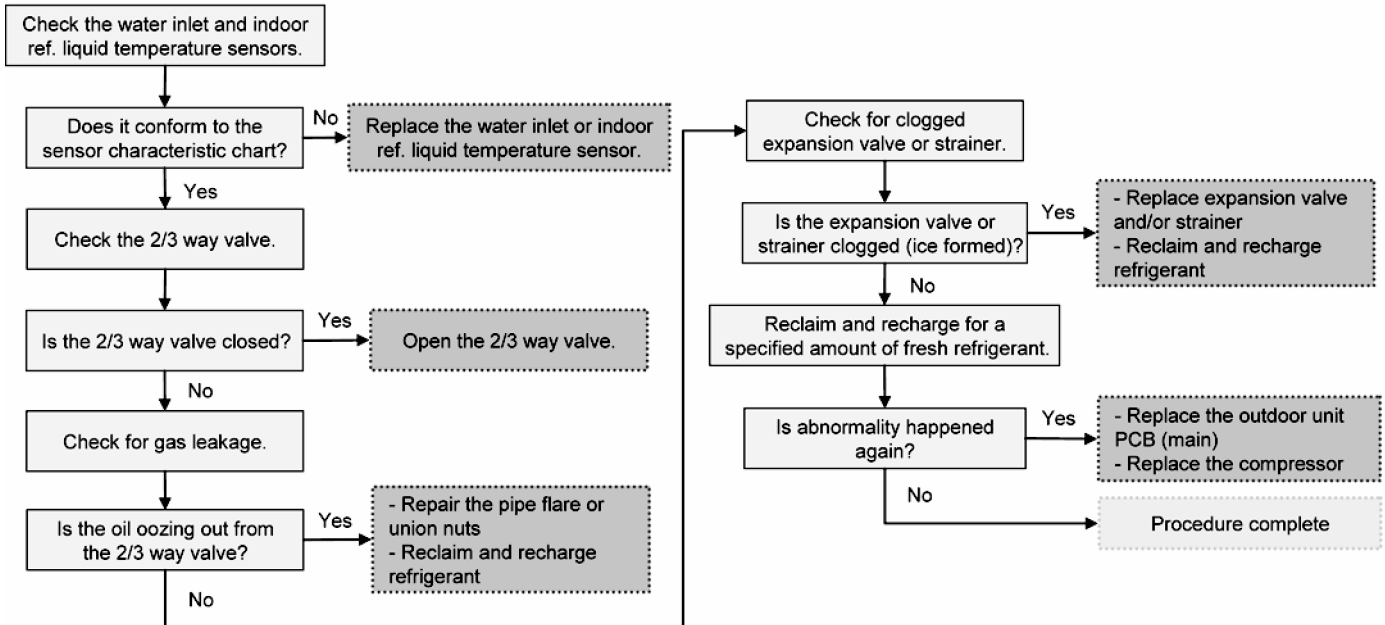

16.5.24 Four Way Valve Abnormality (F25)

Malfunction Decision Conditions:

During heating operation, when the indoor pipe temperature of thermostat ON indoor unit $< 0^{\circ}\text{C}$.

Malfunction Caused:

- 1 Faulty sensor.
- 2 Faulty connector connection.
- 3 Faulty outdoor unit PCB (noise filter/main).
- 4 Faulty four way valve.

Abnormality Judgment:

Continue 4 times in 30 minutes.

Troubleshooting:



Caution

For safety reason and to prevent component breakdown, always switch off the power before remove and connect the component.

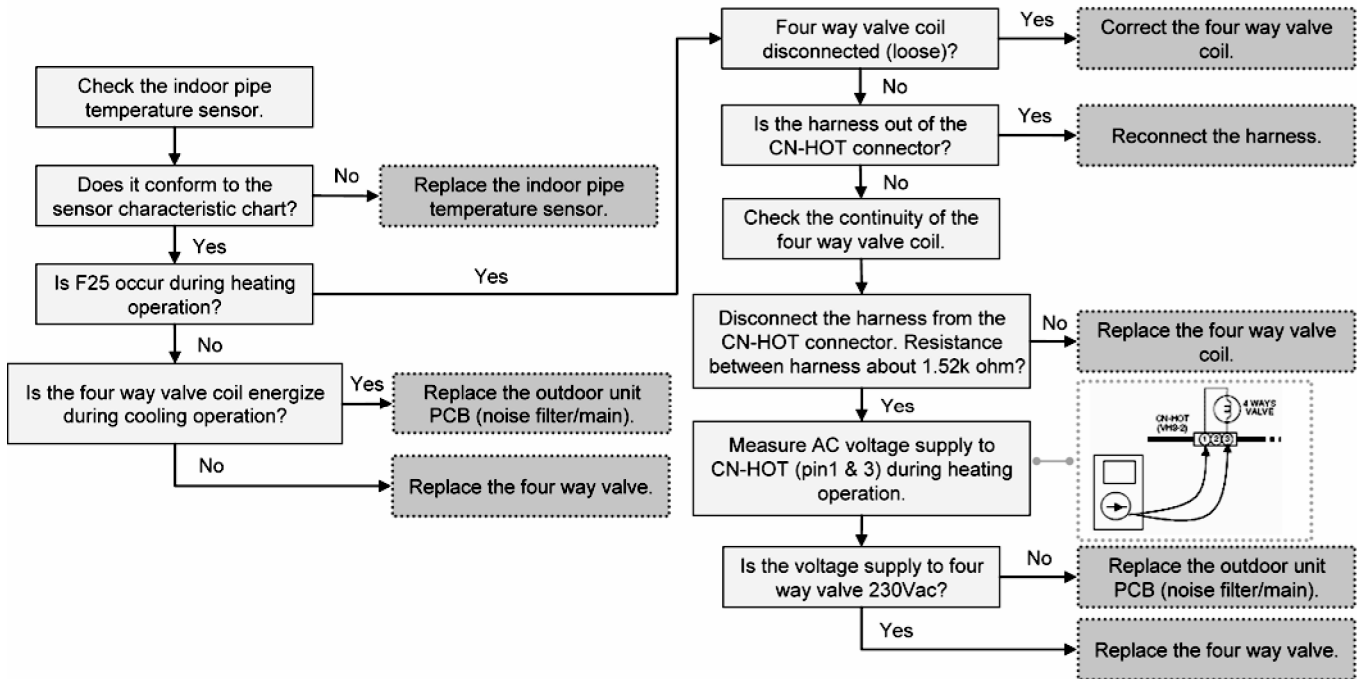

16.5.25 Outdoor High Pressure Switch Abnormal (F27)

Malfunction Decision Conditions:

During compressor stop, and outdoor high pressure switch is remain opened.

Malfunction Caused:

- 1 Faulty connector connection.
- 2 Faulty switch.
- 3 Faulty outdoor unit PCB (main).

Abnormality Judgment:

Continue for 1 minute.

Troubleshooting:



Caution

For safety reason and to prevent component breakdown, always switch off the power before remove and connect the component.

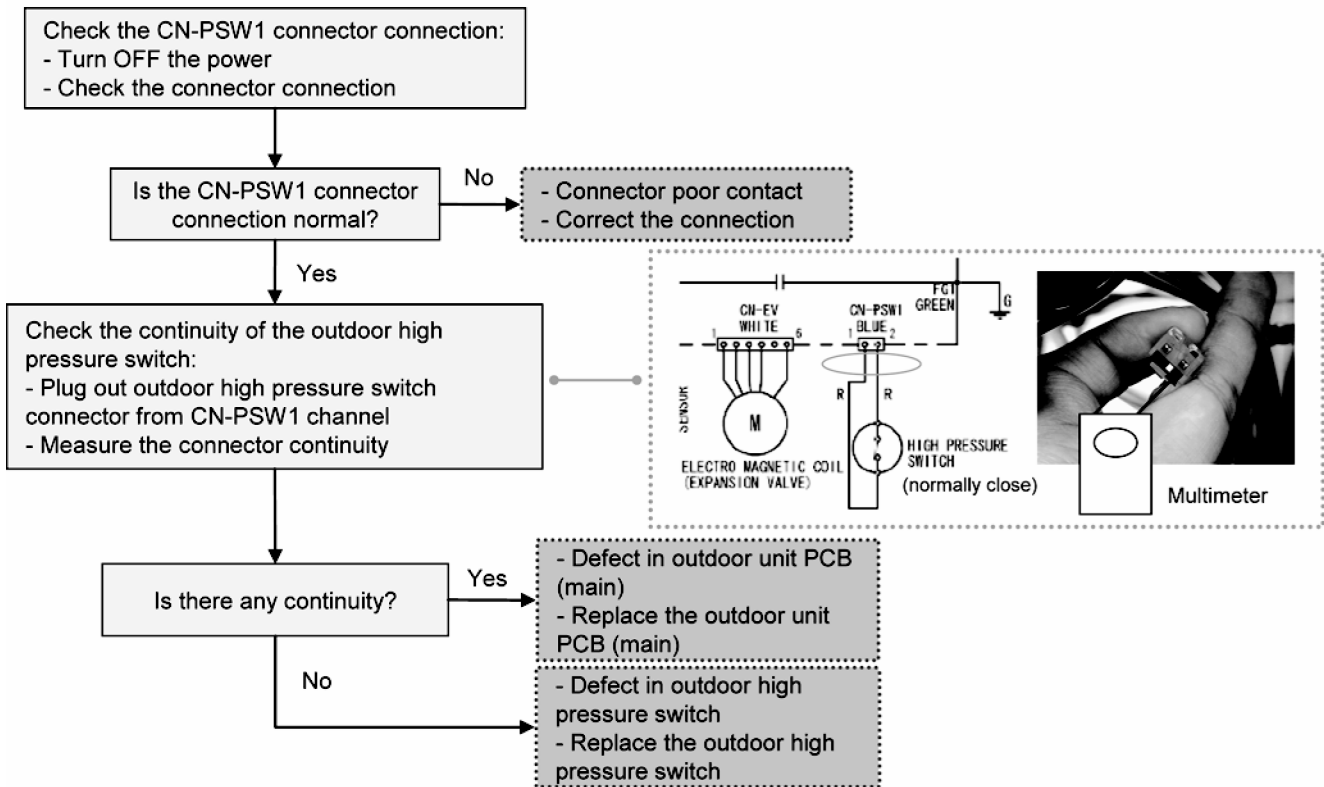

16.5.26 Outdoor Air Temperature Sensor Abnormality (F36)

Malfunction Decision Conditions:

During startup and operation of heating, the temperatures detected by the outdoor air temperature sensor are used to determine sensor error.

Malfunction Caused:

- 1 Faulty connector connection.
- 2 Faulty sensor.
- 3 Faulty outdoor unit PCB (main).

Abnormality Judgment:

Continue for 5 seconds.

Troubleshooting:



Caution

For safety reason and to prevent component breakdown, always switch off the power before remove and connect the component.

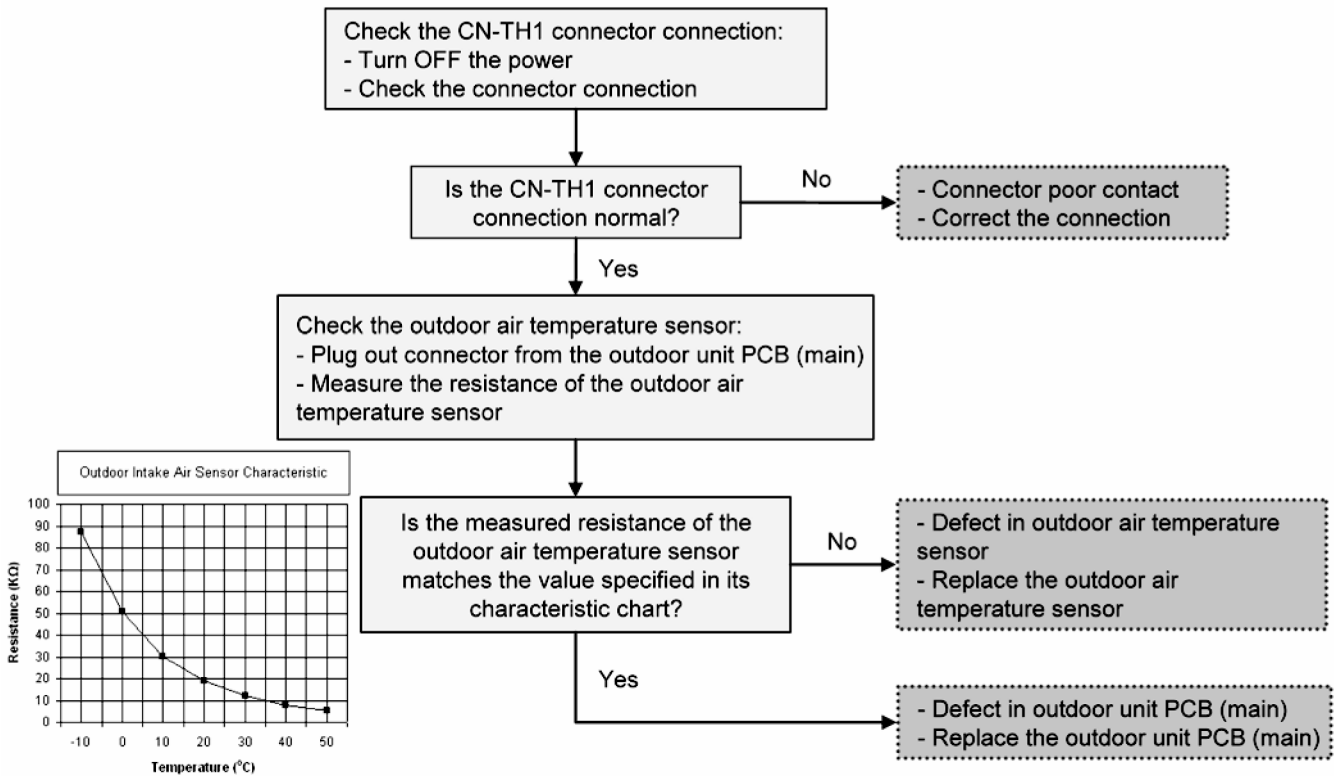

16.5.27 Indoor Water Inlet Temperature Sensor Abnormality (F37)

Malfunction Decision Conditions:

During startup and operation of heating, the temperatures detected by the indoor water inlet temperature sensor are used to determine sensor error.

Malfunction Caused:

- 1 Faulty connector connection.
- 2 Faulty sensor.
- 3 Faulty indoor unit PCB (main).

Abnormality Judgment:

Continue for 5 seconds.

Troubleshooting:



Caution

For safety reason and to prevent component breakdown, always switch off the power before remove and connect the component.

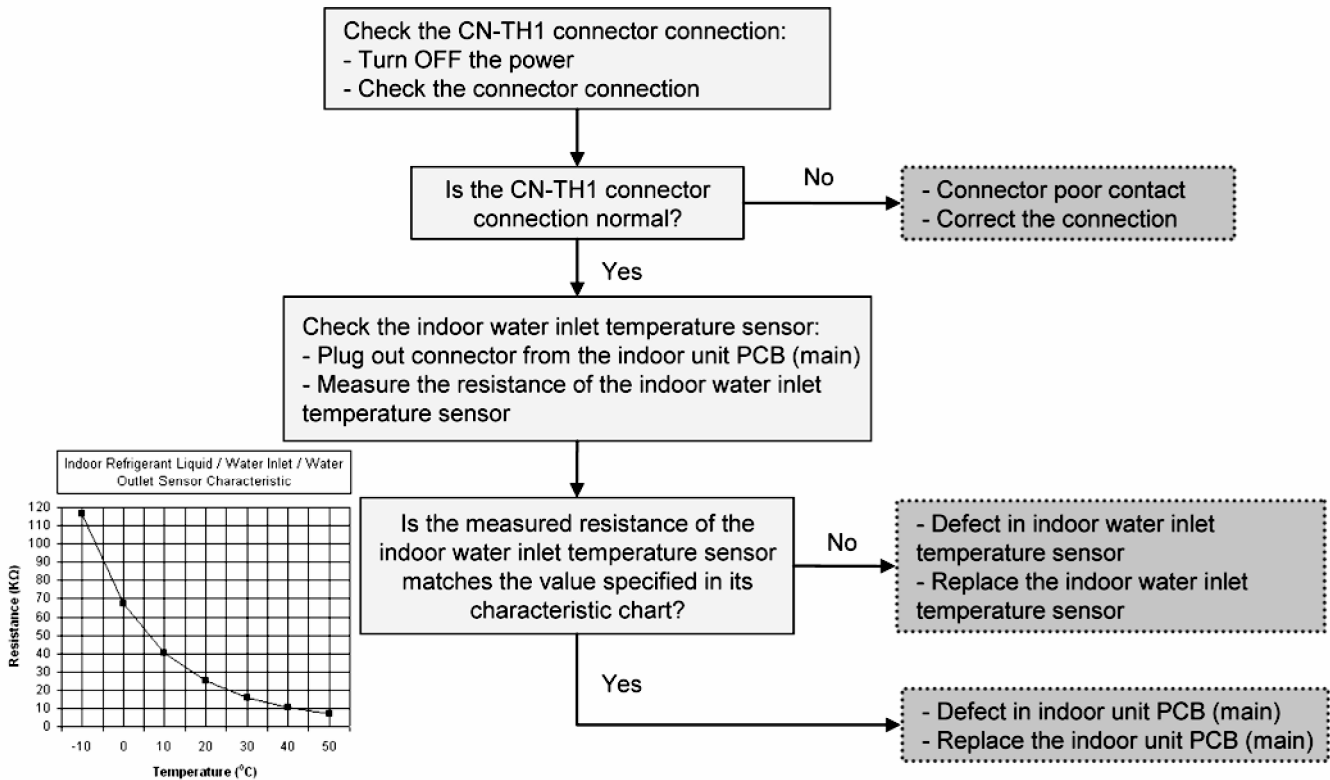

16.5.28 Outdoor Discharge Pipe Temperature Sensor Abnormality (F40)

Malfunction Decision Conditions:

During startup and operation of heating, the temperatures detected by the outdoor discharge pipe temperature sensor are used to determine sensor error.

Malfunction Caused:

- 1 Faulty connector connection.
- 2 Faulty sensor.
- 3 Faulty outdoor unit PCB (main).

Abnormality Judgment:

Continue for 5 seconds.

Troubleshooting:



Caution

For safety reason and to prevent component breakdown, always switch off the power before remove and connect the component.

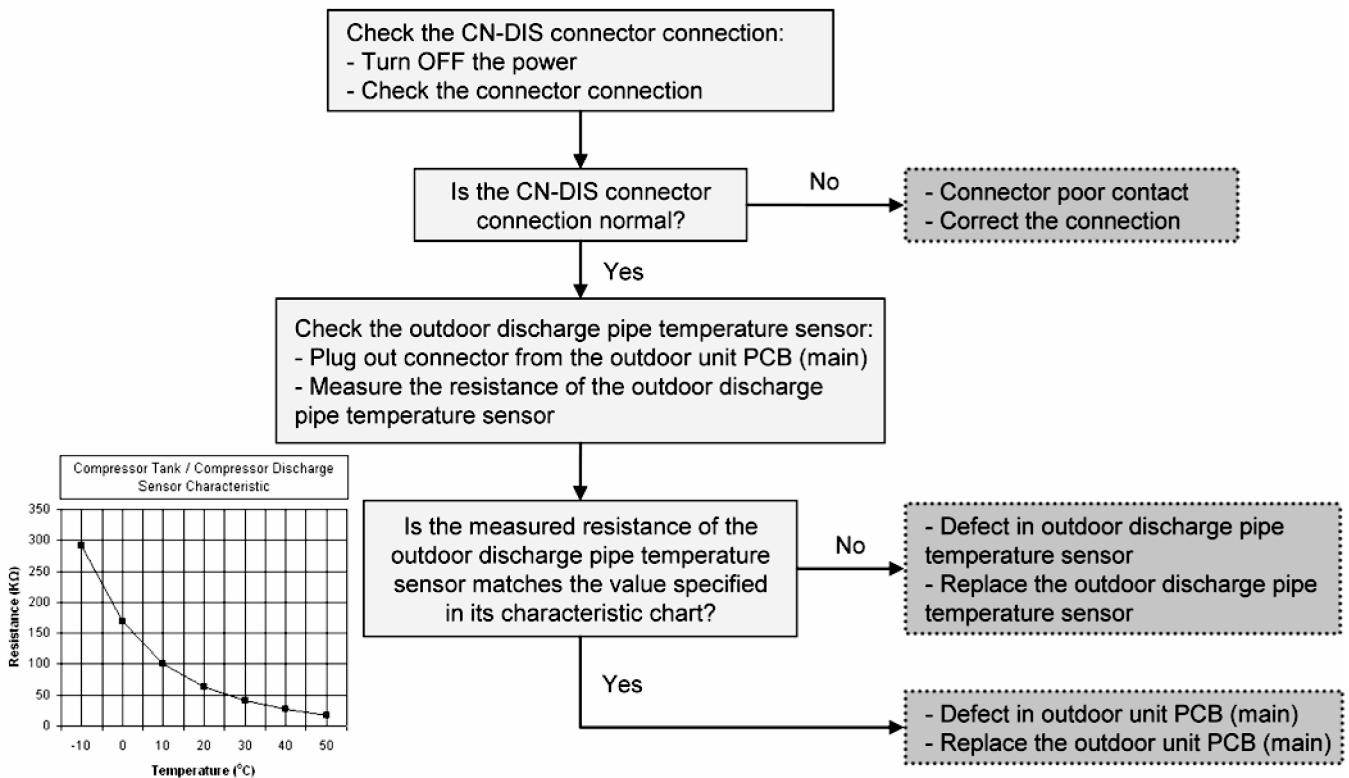

16.5.29 Power Factor Correction (PFC) Abnormality (F41)

Malfunction Decision Conditions:

During operation of heating, when the PFC protection circuitry in the outdoor unit PCB (main) senses abnormal high DC voltage level.

Malfunction Caused:

- 1 Power supply surge.
- 2 Compressor windings not uniform.
- 3 Faulty outdoor unit PCB (main).

Abnormality Judgment:

Continue 4 times in 10 minutes.

Troubleshooting:



Caution

For safety reason and to prevent component breakdown, always switch off the power before remove and connect the component.

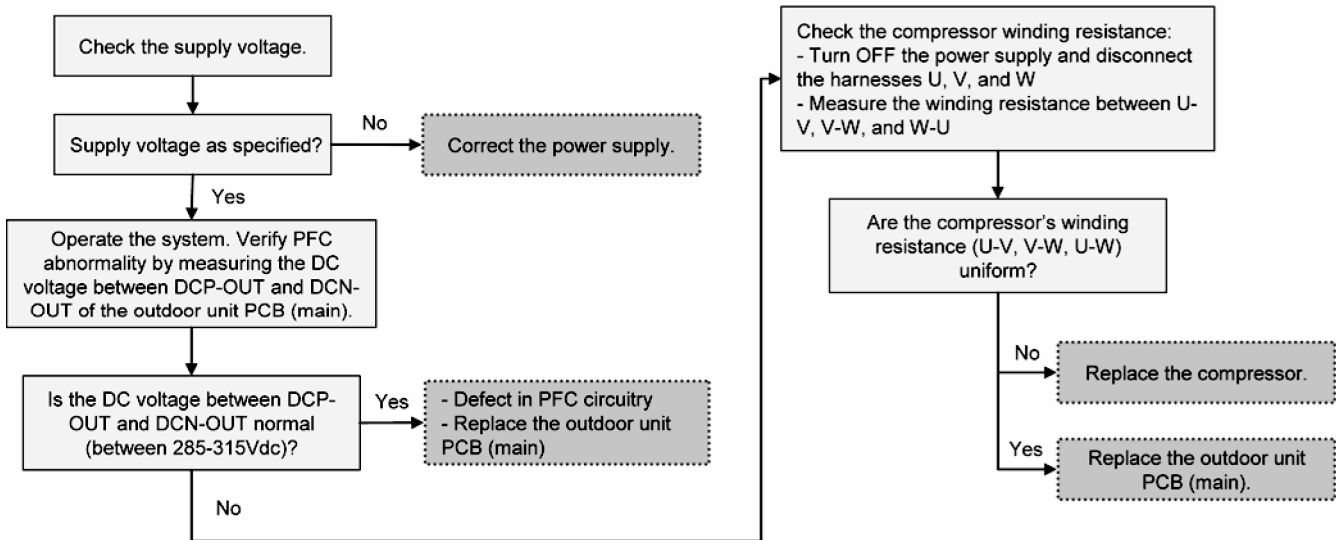

16.5.30 Outdoor Pipe Temperature Sensor Abnormality (F42)

Malfunction Decision Conditions:

During startup and operation of heating, the temperatures detected by the outdoor pipe temperature sensor are used to determine sensor error.

Malfunction Caused:

- 1 Faulty connector connection.
- 2 Faulty sensor.
- 3 Faulty outdoor unit PCB (main).

Abnormality Judgment:

Continue for 5 seconds.

Troubleshooting:



Caution

For safety reason and to prevent component breakdown, always switch off the power before remove and connect the component.

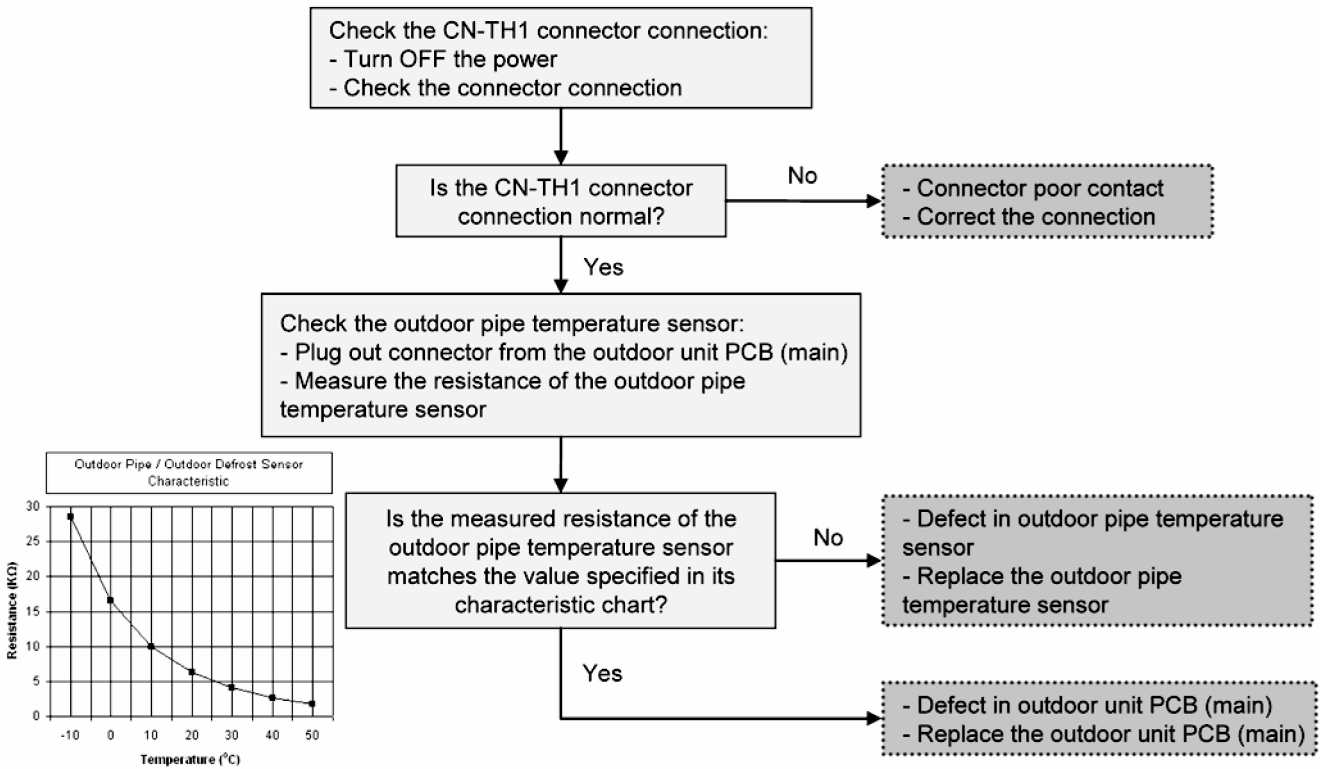

16.5.31 Outdoor Defrost Temperature Sensor Abnormality (F43)

Malfunction Decision Conditions:

During startup and operation of heating, the temperatures detected by the outdoor defrost temperature sensor are used to determine sensor error.

Malfunction Caused:

- 1 Faulty connector connection.
- 2 Faulty sensor.
- 3 Faulty outdoor unit PCB (main).

Abnormality Judgment:

Continue for 5 seconds.

Troubleshooting:



Caution

For safety reason and to prevent component breakdown, always switch off the power before remove and connect the component.

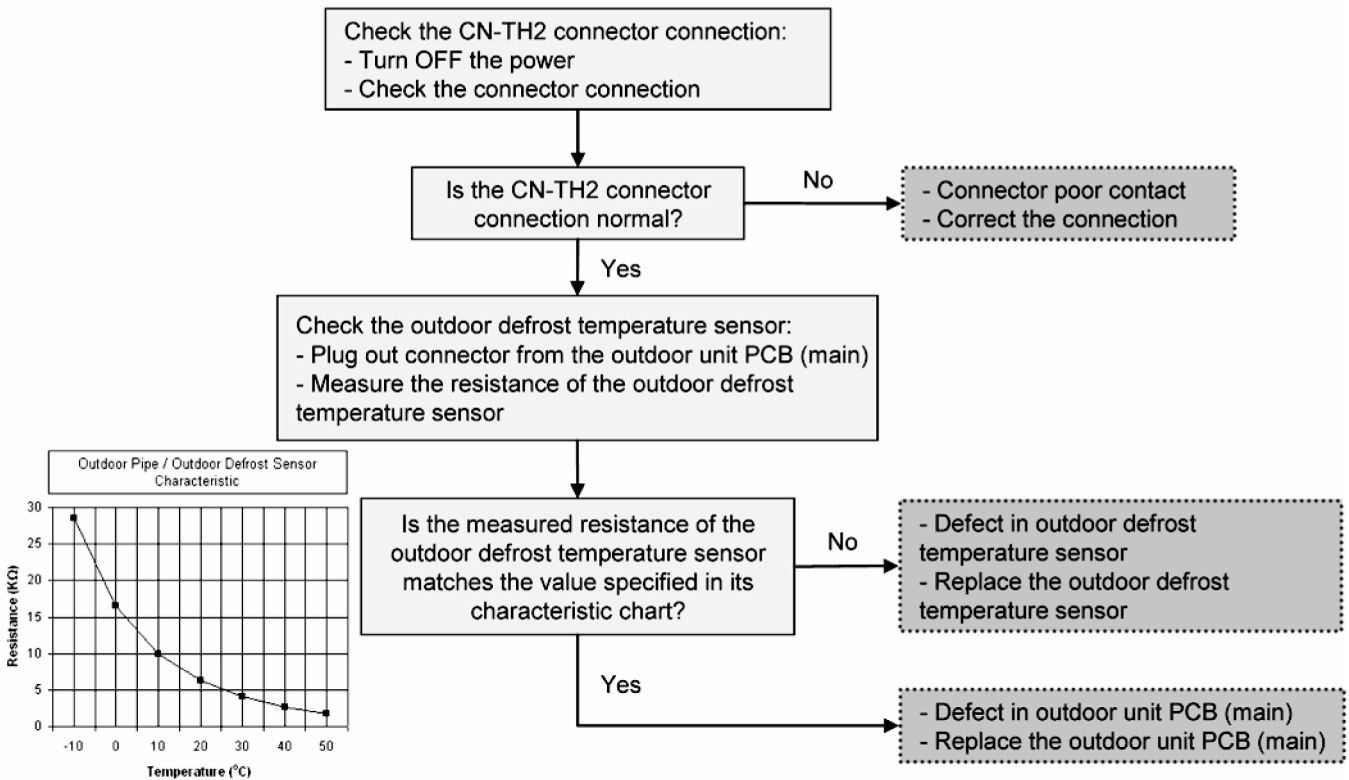

16.5.32 Indoor Water Outlet Temperature Sensor Abnormality (F45)

Malfunction Decision Conditions:

During startup and operation of heating, the temperatures detected by the indoor water outlet temperature sensor are used to determine sensor errors.

Malfunction Caused:

- 1 Faulty connector connection.
- 2 Faulty sensor.
- 3 Faulty indoor unit PCB (main).

Abnormality Judgment:

Continue for 5 seconds.

Troubleshooting:



Caution

For safety reason and to prevent component breakdown, always switch off the power before remove and connect the component.

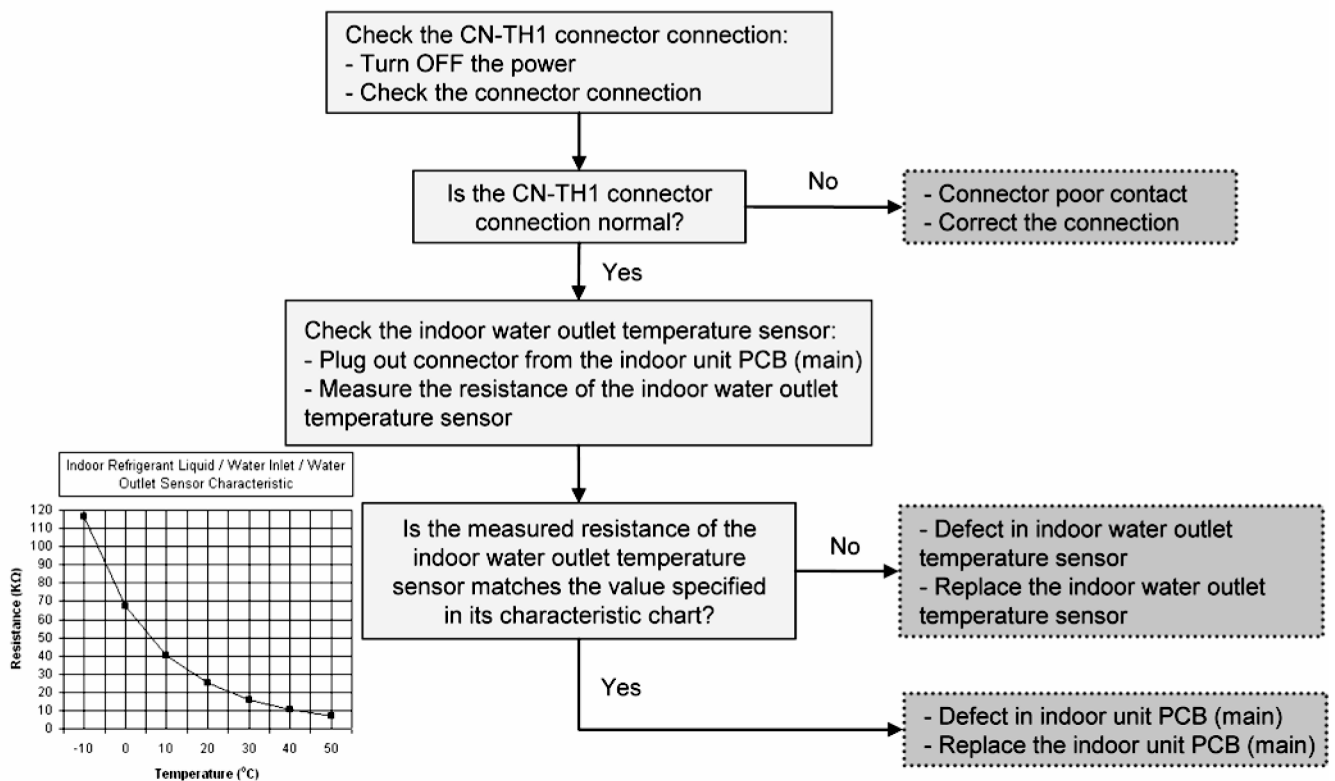

16.5.33 Outdoor Current Transformer Open Circuit (F46)

Malfunction Decision Conditions:

A current transformer (CT) open circuit is detected by checking the compressor running frequency (\geq rated frequency) and CT detected input current ($< 0.65A$) for continuously 20 seconds.

Malfunction Caused:

- 1 CT defective.
- 2 Faulty outdoor unit PCB.
- 3 Compressor defective (low compression).

Abnormality Judgment:

Continue 3 times in 20 seconds.

Troubleshooting:



For safety reason and to prevent component breakdown, always switch off the power before remove and connect the component.

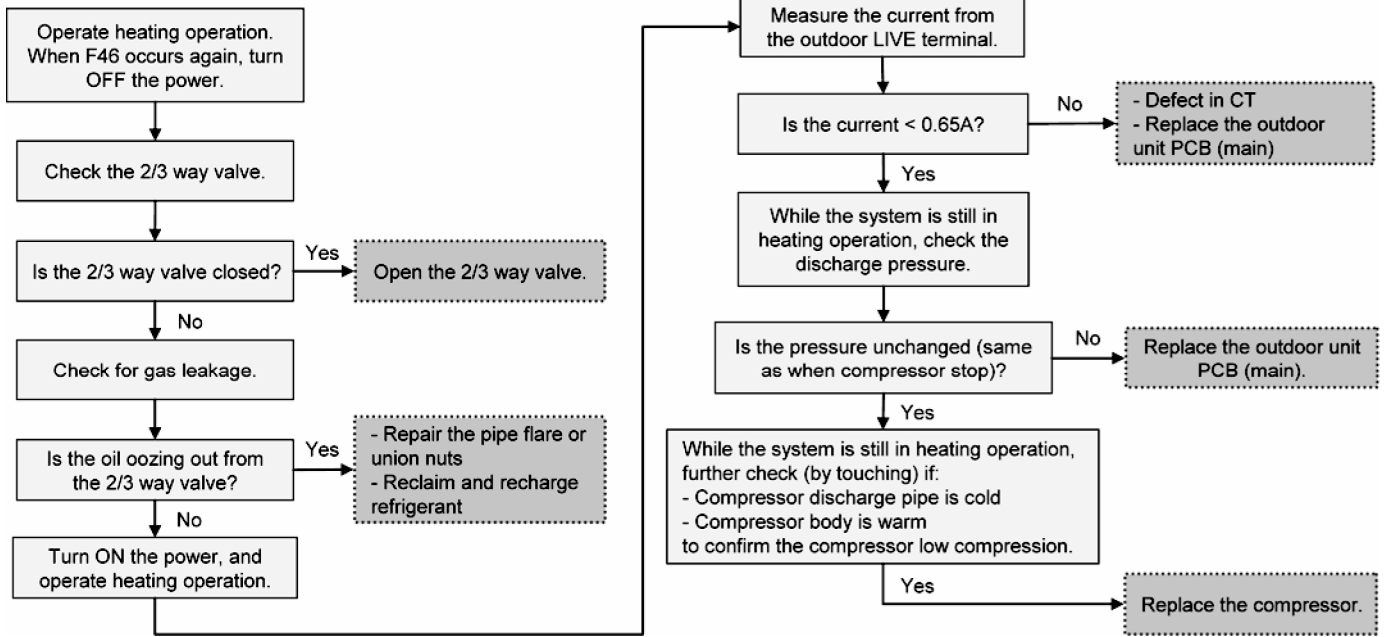

16.5.34 Cooling High Pressure Overload Protection (F95)

Malfunction Decision Conditions:

During operation of cooling, when pressure 4.0MPa and above is detected by outdoor high pressure sensor.

Malfunction Caused:

- 1 Dust accumulation in the outdoor unit heat exchanger.
- 2 Air short circuit at outdoor unit.
- 3 2 way valve closed.
- 4 Faulty outdoor unit fan motor.
- 5 Clogged expansion valve or strainer.
- 6 Excessive refrigerant.
- 7 Faulty outdoor high pressure sensor.
- 8 Faulty outdoor unit PCB (main).

Troubleshooting:



Caution

For safety reason and to prevent component breakdown, always switch off the power before remove and connect the component.

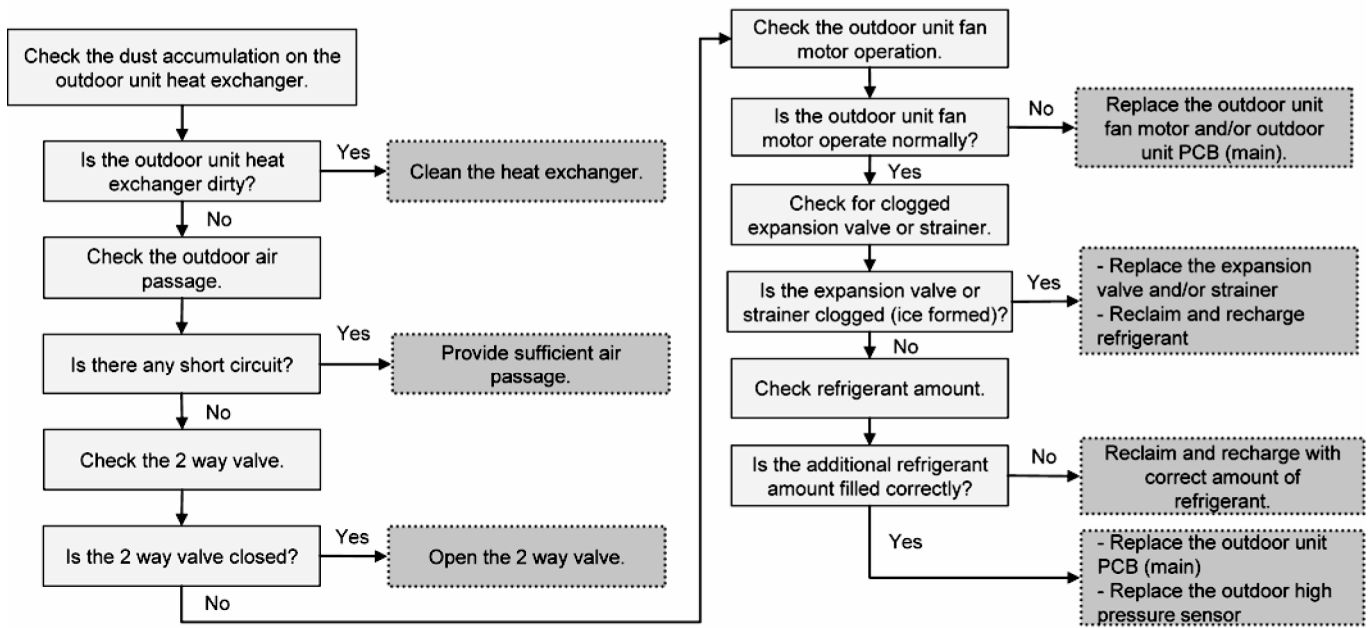

17. Disassembly and Assembly Instructions



High Voltage are generated in the electrical parts area by the capacitor. Ensure that the capacitor has discharged sufficiently before proceeding with repair work. Failure to heed this caution may result in electric shocks.



Be sure to switch off all the power supply before performing each of the below action.

17.1 To Remove The Cabinet Front Plate

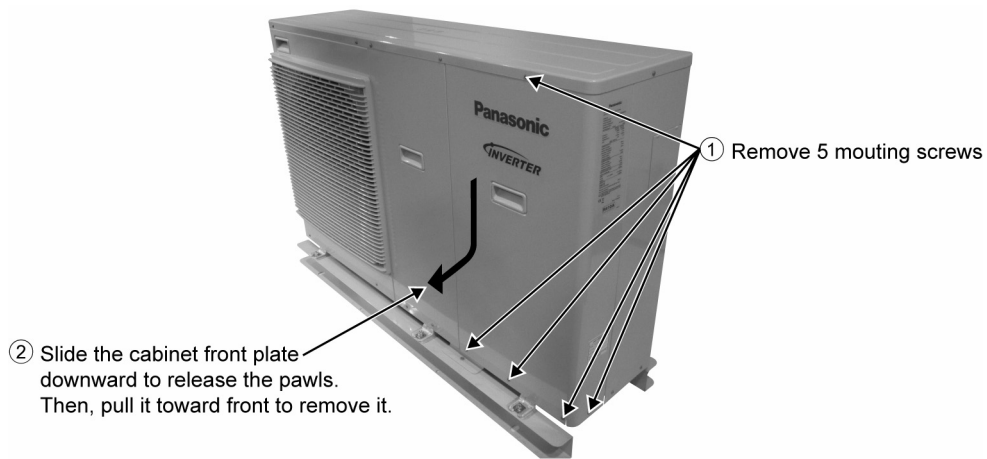

17.2 To Remove The Cabinet Top Plate

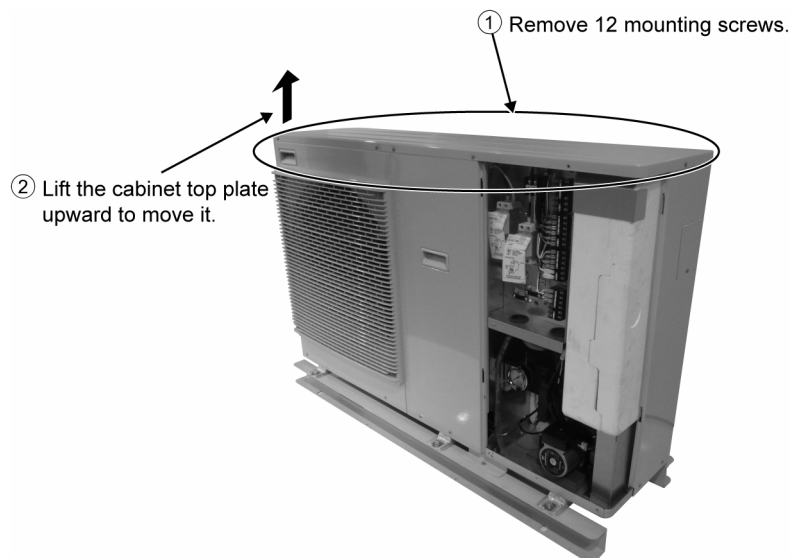

17.3 To Remove The Cabinet Rear Plate

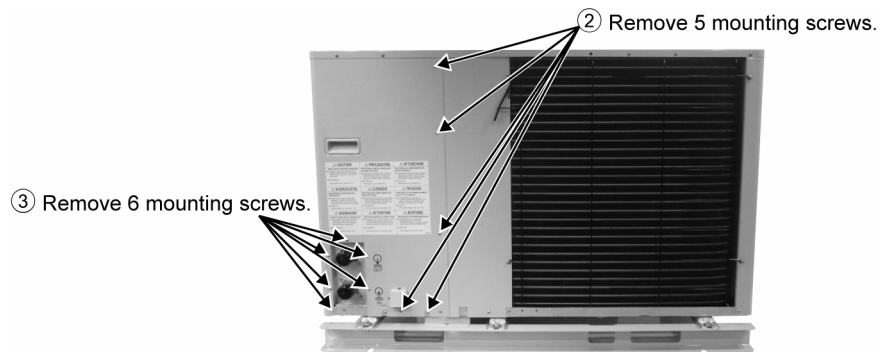
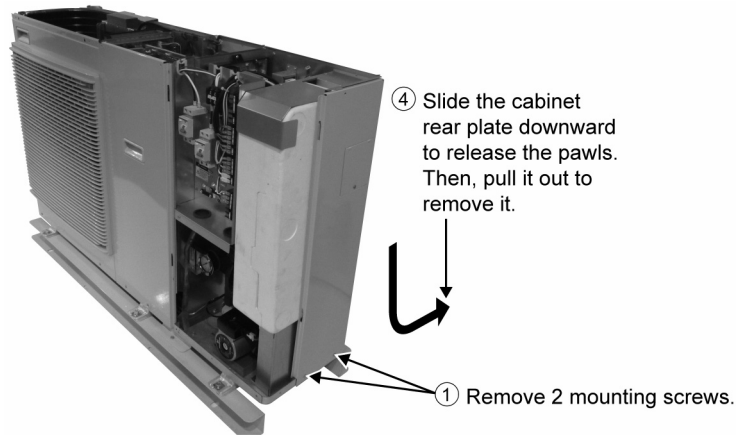

17.4 To Remove Pressure Gauge

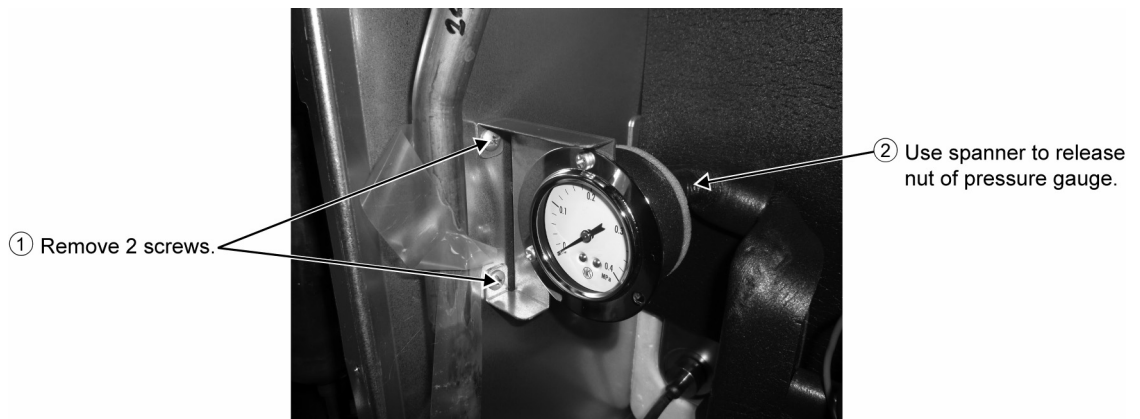

17.5 To Remove RCCB

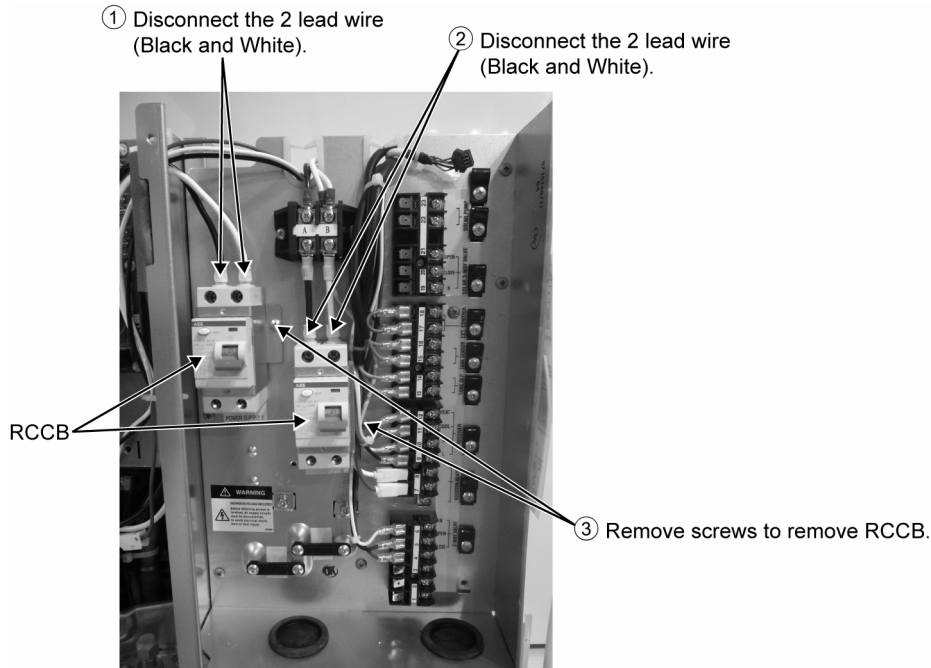

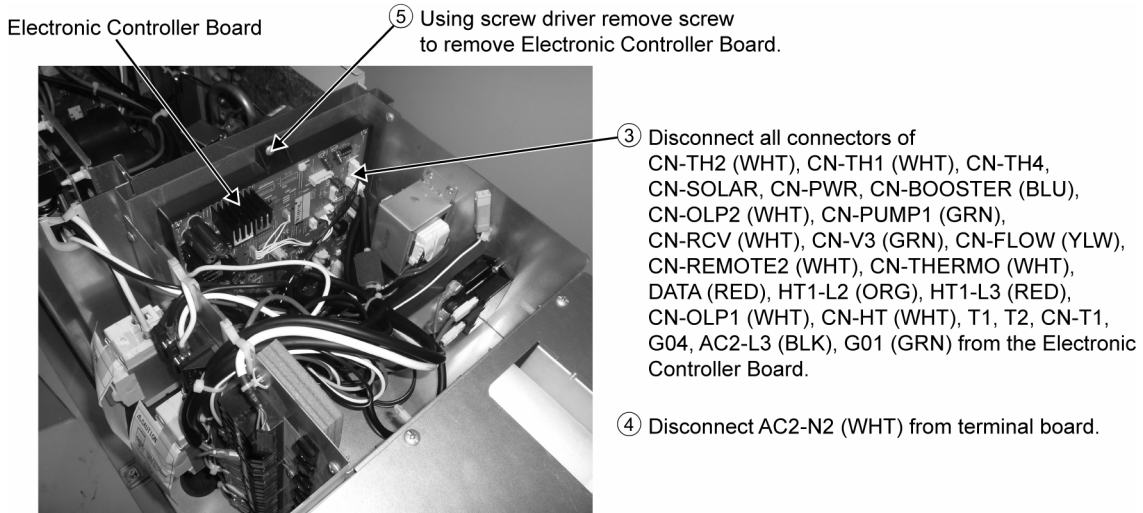
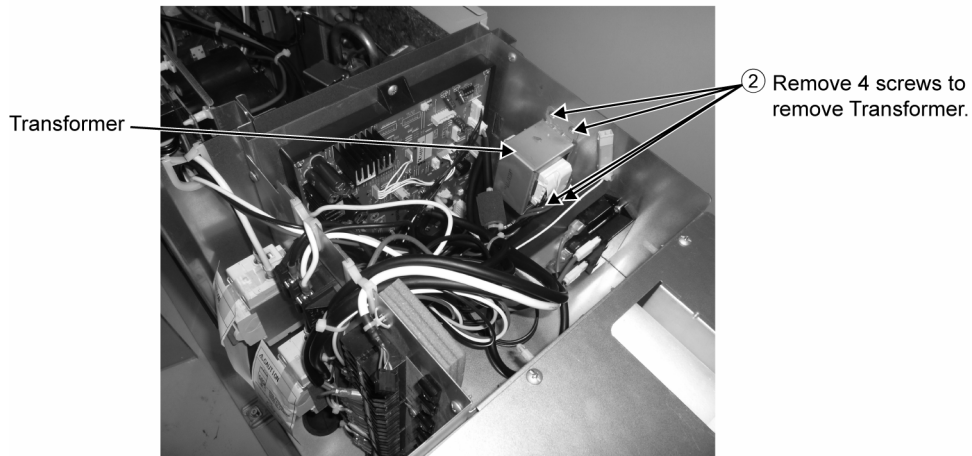

17.6 To Remove Transformer and Electronic Controller Board

- ① Disconnect the 2 lead wire T1, T2 (Black) and connector CN-T1 (Red) from the Electronic Controller board.



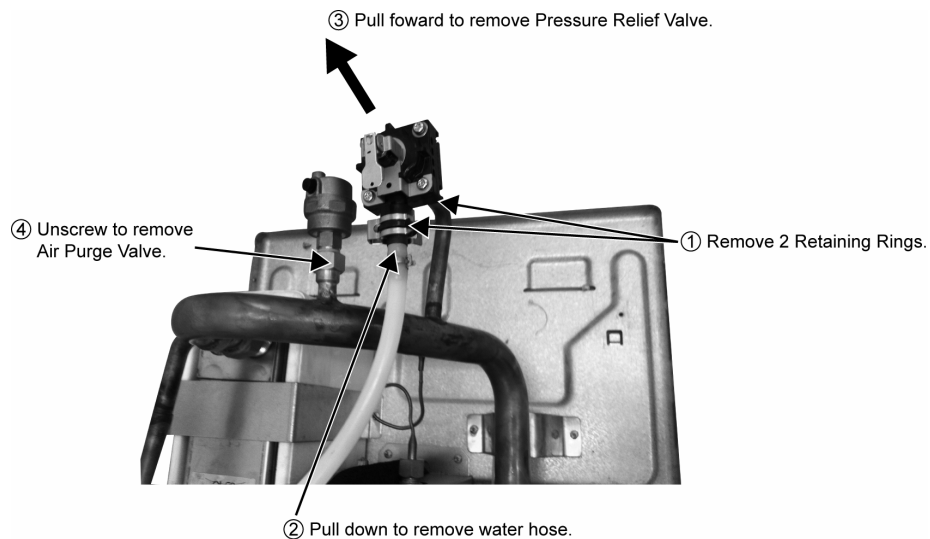

17.7 To Remove Pressure Relief Valve and Air Purge Valve

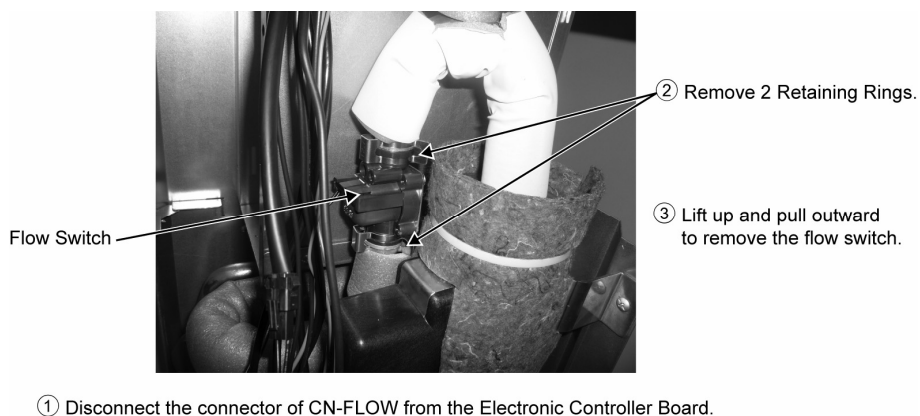

 When reinstall the water pipe, use grease or water at the joining.

17.8 To Remove Flow Switch



 When reinstall the water pipe, use grease or water at the joining.

17.9 To Remove Water Pump

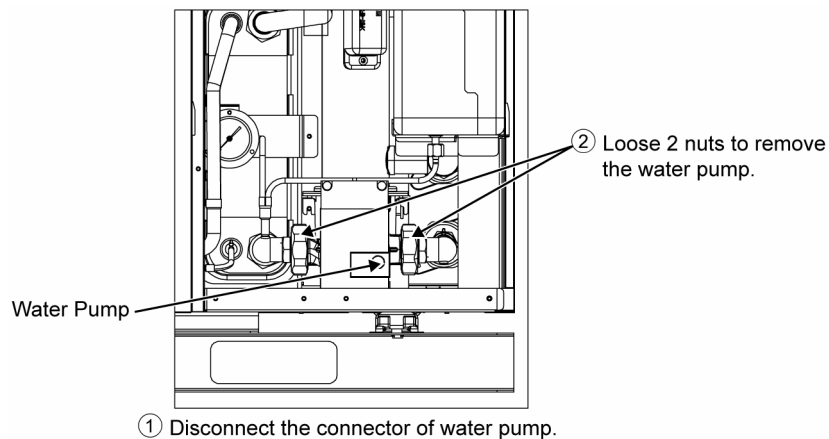

 When reinstall the water pipe, use grease or water at the joining.

18. Technical Data

18.1 Operation Characteristics

18.1.1 WH-MDF06E3E5

Heating Characteristics at Different Outdoor Air Temperature

Condition

Outdoor air temperature : 7°C (DBT), 6°C (WBT)

Indoor water inlet temperature : 30°C

Indoor water outlet temperature : 35°C

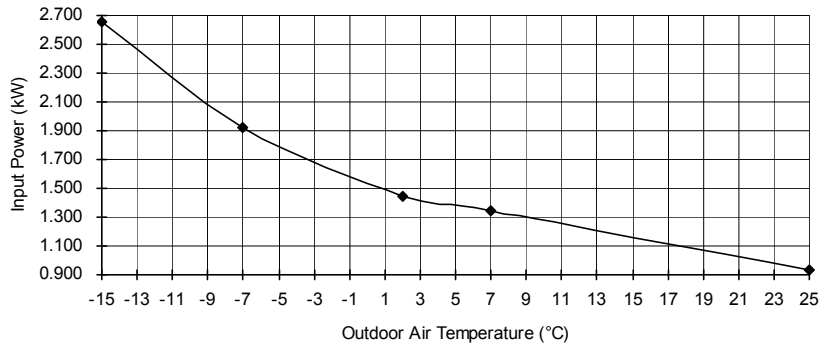
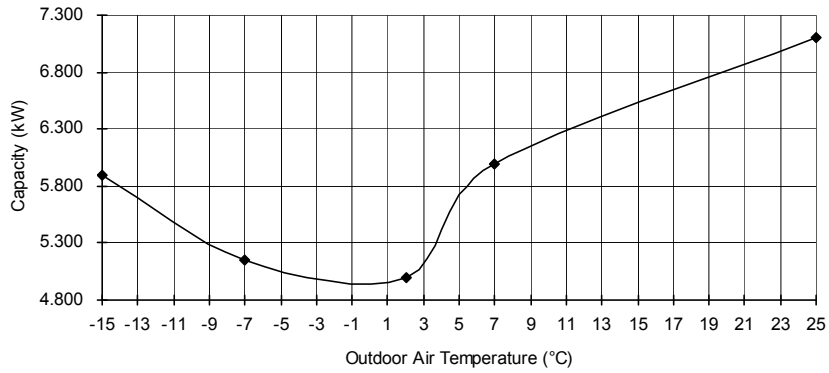

18.1.2 WH-MDF09E3E5

Heating Characteristics at Different Outdoor Air Temperature

Condition

Outdoor air temperature : 7°C (DBT), 6°C (WBT)

Indoor water inlet temperature : 30°C

Indoor water outlet temperature : 35°C

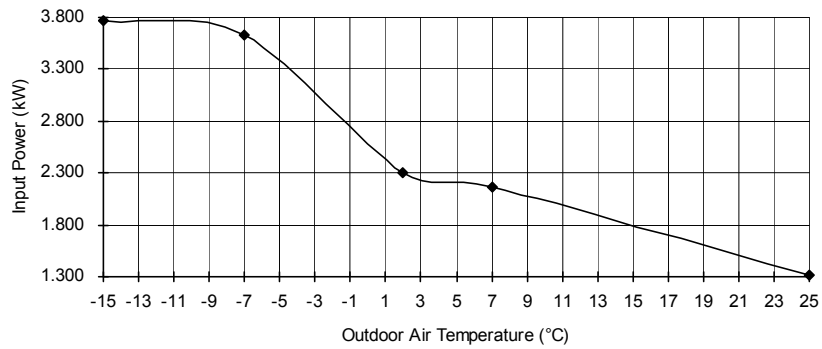
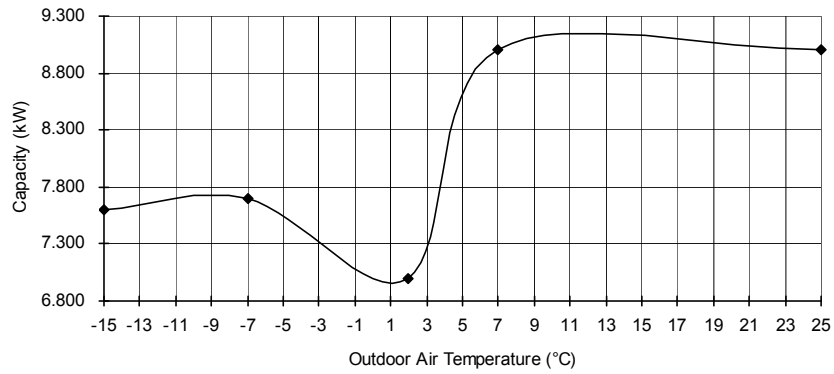

18.2 Heating Capacity Table

18.2.1 WH-MDF06E3E5

Water Out	30		35		40		45		50		55	
Outdoor Air	Capacity	Input Power	Capacity	Input Power	Capacity	Input Power	Capacity	Input Power	Capacity	Input Power	Capacity	Input Power
-15	6150	2500	5900	2660	5650	2820	5400	2980	5200	3150	5000	3320
-7	5175	1675	5150	1920	5125	2165	5100	2410	5450	2805	5800	3200
2	5000	1225	5000	1450	5000	1675	5000	1900	5000	2190	5000	2480
7	6000	1125	6000	1345	6000	1575	6000	1800	6000	2090	6000	2380
25	7300	775	7100	930	6900	1085	6700	1240	6500	1410	6300	1580

18.2.2 WH-MDF09E3E5

Water Out	30		35		40		45		50		55	
Outdoor Air	Capacity	Input Power	Capacity	Input Power	Capacity	Input Power	Capacity	Input Power	Capacity	Input Power	Capacity	Input Power
-15	7900	3615	7600	3770	7300	3925	7000	4080	6450	4055	5900	4030
-7	7800	3380	7700	3630	7600	3880	7500	4130	7550	4590	7600	5050
2	7000	2005	7000	2300	7000	2595	7000	2890	7000	3370	7000	3850
7	9000	1865	9000	2165	9000	2475	9000	2780	8950	3310	8900	3840
25	9000	990	9000	1310	9000	1630	9000	1950	9000	2200	9000	2450

18.3 Hydraulic Pump Performance



Constant Pressure Head Difference ($\Delta p-c$)



Variable Pressure Head Difference ($\Delta p-v$)

At $\Delta P-C$

When pressure loss of system increased, pump speed will be reduced for maintain constant pressure.

At $\Delta P-V$

When pressure loss of system increased, pump speed will be reduced for maintain pressure according to water flow rate.

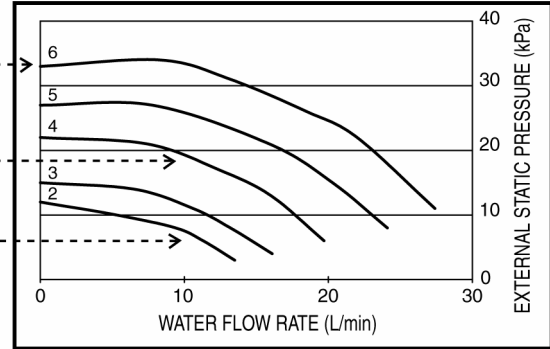
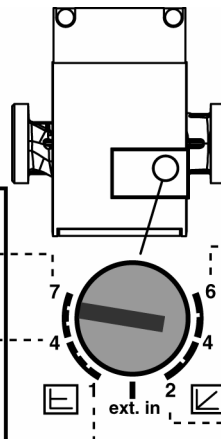
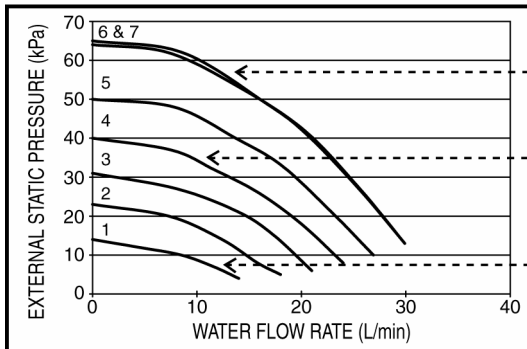

19. Exploded View and Replacement Parts List

19.1 WH-MDF06E3E5 WH-MDF09E3E5 (Refrigerant System)

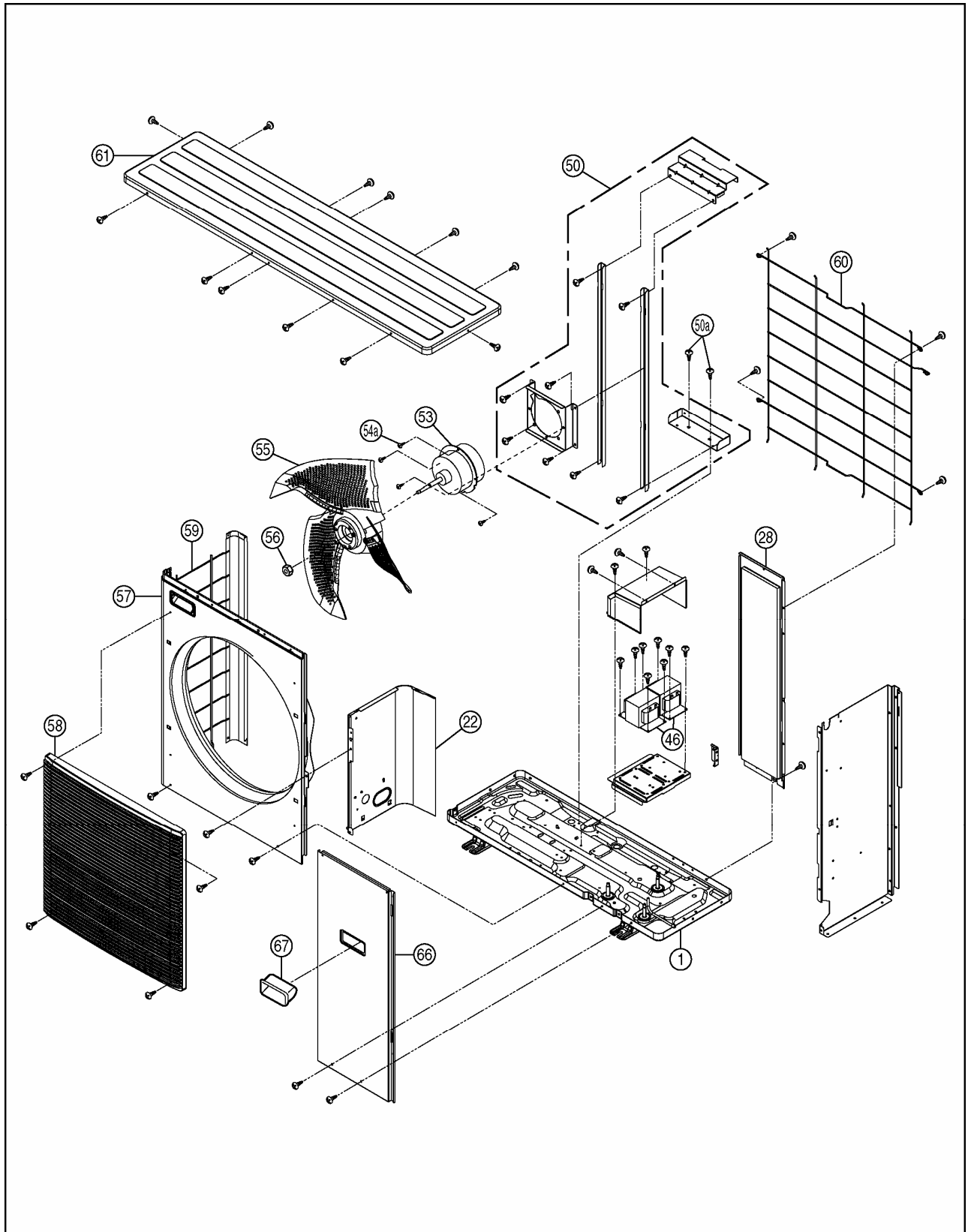

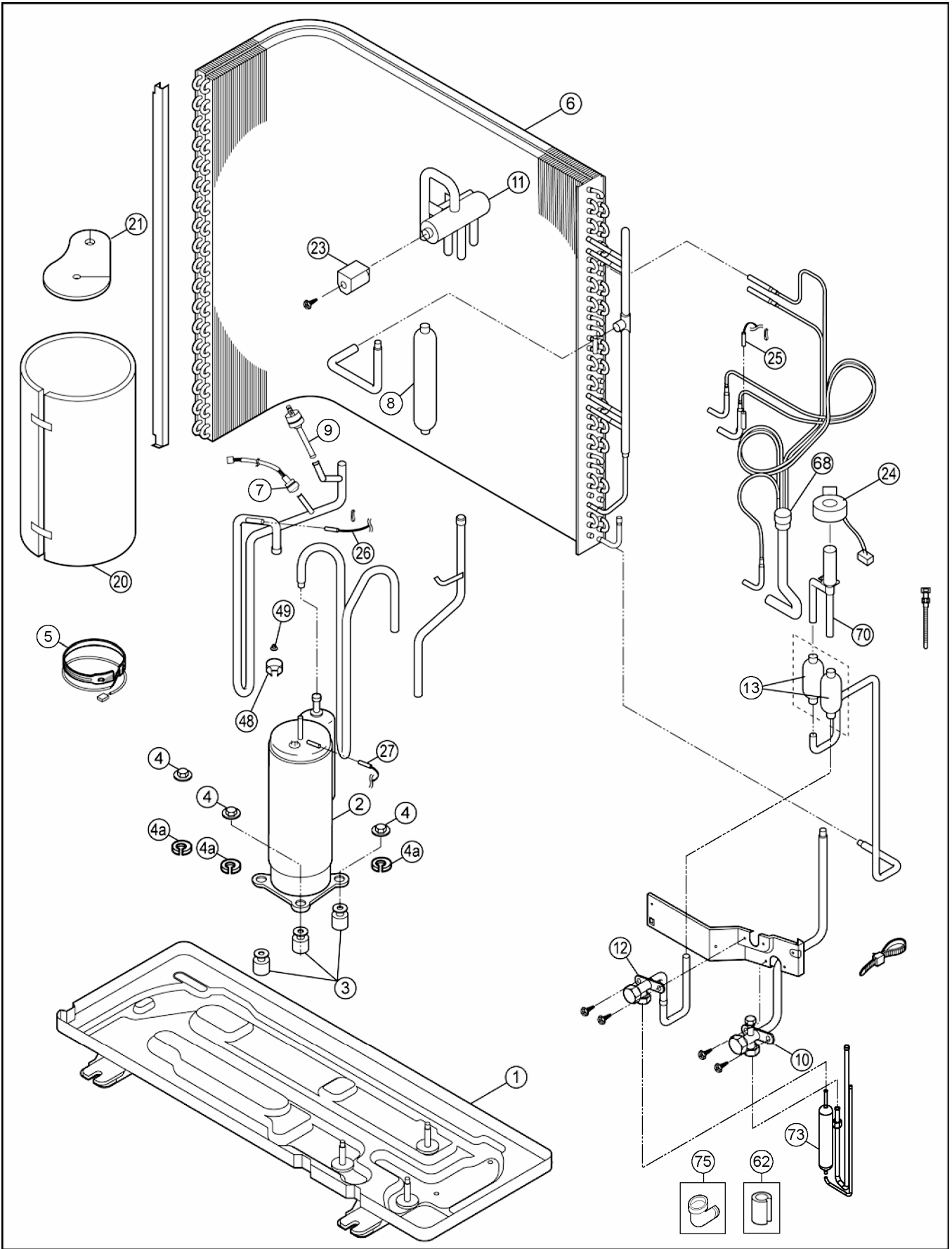

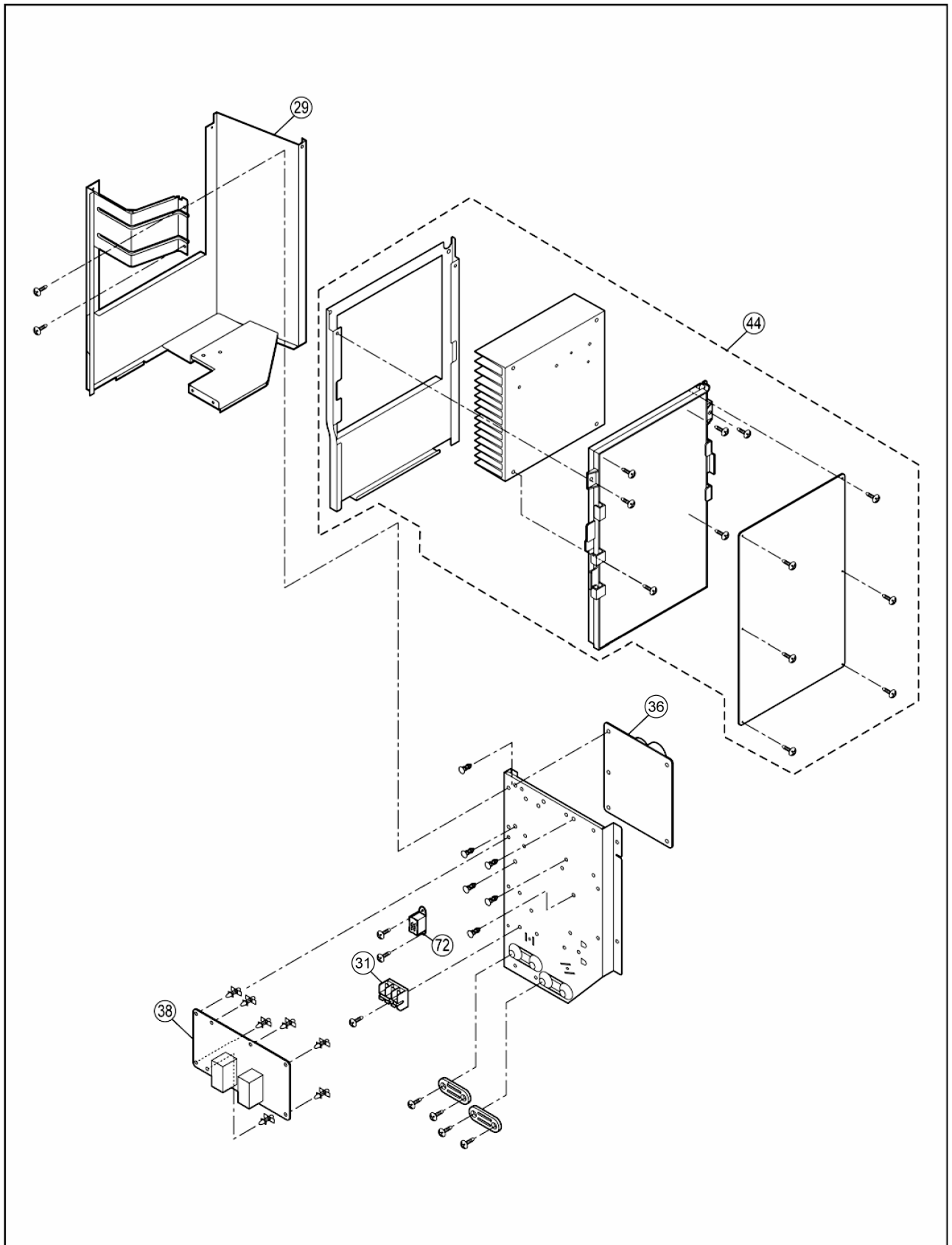

Note:

- The above exploded view is for the purpose of parts disassembly and replacement.
- The non-numbered parts are not kept as standard service parts.

< Model: Refrigerant System >

REF. NO.	DESCRIPTION & NAME	QTY.	WH-MDF06E3E5	WH-MDF09E3E5	REMARK
1	BASE PAN ASS'Y	1	CWD52K1282	←	
2	COMPRESSOR	1	5KD240XCC21	←	O
3	BUSHING - COMPRESSOR MOUNT	3	CWH50055	←	
4	NUT-COMPRESSOR MOUNT	3	CWH561049	←	
4a	GASKET FOR TERMINAL COVER	3	CWB811017	←	
5	CRANKCASE HEATER	1	CWA341043	←	
6	CONDENSER COMPLETE	1	CWB32C2846	←	
7	HIGH PRESSURE SENSOR	1	CWA50C2570	←	O
8	DISCHARGE MUFFLER	1	CWB121013	←	
9	PRESSURE SWITCH	1	CWA101013	←	O
10	3-WAYS VALVE (GAS)	1	CWB011700	←	O
11	4-WAYS VALVE	1	CWB001026J	←	O
12	2-WAYS VALVE (LIQUID)	1	CWB011698	←	
13	STRAINER	2	CWB111024	←	
20	SOUND PROOF MATERIAL	1	CWG302683	←	
21	SOUND PROOF MATERIAL	1	CWG302246	←	
22	SOUND PROOF BOARD	1	CWH151195	←	
23	V-COIL COMPLETE - 4-WAY VALVE	1	CWA43C2169J	←	O
24	V-COIL COMPLETE - EXP.VALVE	1	CWA43C2342	←	O
25	SENSOR-COMPLETE	1	CWA50C2652	←	O
26	SENSOR-COMP.DISCHARGE	1	CWA50C2528	←	O
27	SENSOR-COMP.TANK	1	CWA50C2665	←	O
28	CABINET REAR PLATE-COMPLETE	1	CWE02C1062	←	
29	CONTROL BOARD CASING	1	CWH10K1150	←	
31	TERMINAL BOARD ASS'Y	1	CWA28K1251	←	O
36	ELECTRONIC CONTROLLER-CAPACITOR	1	CWA746184	←	O
38	ELECTRONIC CONTROLLER-NOISE FILTER	1	CWA745745	←	
44	ELECTRONIC CONTROLLER (MAIN)	1	CWA73C7077R	CWA73C7078R	O
46	REACTOR	2	G0C592J00005	←	O
48	TERMINAL COVER	1	CWH171039A	←	
49	NUT-TERMINAL COVER	1	CWH7080300J	←	
50	FAN MOTOR BRACKET	1	CWD54K1052	←	
50a	SCREW-FAN MOTOR BRACKET	2	CWH551040J	←	
53	FAN MOTOR	1	EHDS80C60AC	←	O
54a	SCREW-FAN MOTOR MOUNT	4	CWH551323	←	
55	PROPELLER FAN ASSY	1	CWH00K1006	←	
56	NUT	1	CWH561092	←	
57	CABINET FRONT PLATE	1	CWE061118A	←	
58	DISCHARGE GRILLE	1	CWE201073	←	
59	CABINET SIDE PLATE ASSY	1	CWE04K1019A	←	
60	WIRE NET	1	CWD041102A	←	
61	CABINET TOP PLATE	1	CWE03C1105	←	
62	ACCESSORY CO.(RUBBER CAP)	1	CWH82C1839	←	
66	CABINET FRONT PLATE	1	CWE06C1359	←	
67	HANDLE	2	CWE161008	←	
68	TUBE ASSY (CAP.TUBE)	1	CWT07K1547	←	
70	EXPANSION VALVE	1	CWB051029	←	O
72	ELECTRO MAGNETIC SWITCH	1	CWA001023	←	O
73	RECEIVER	1	CWB141070	←	
75	ACCESSORY CO. (DRAIN ELBOW)	1	CWG87C2030	←	

Note:

- All parts are supplied from PAPAMY, Malaysia (Vendor Code: 00029488).
- "O" marked parts are recommended to be kept in stock.

**19.2 WH-MDF06E3E5 WH-MDF09E3E5
(Water System)**

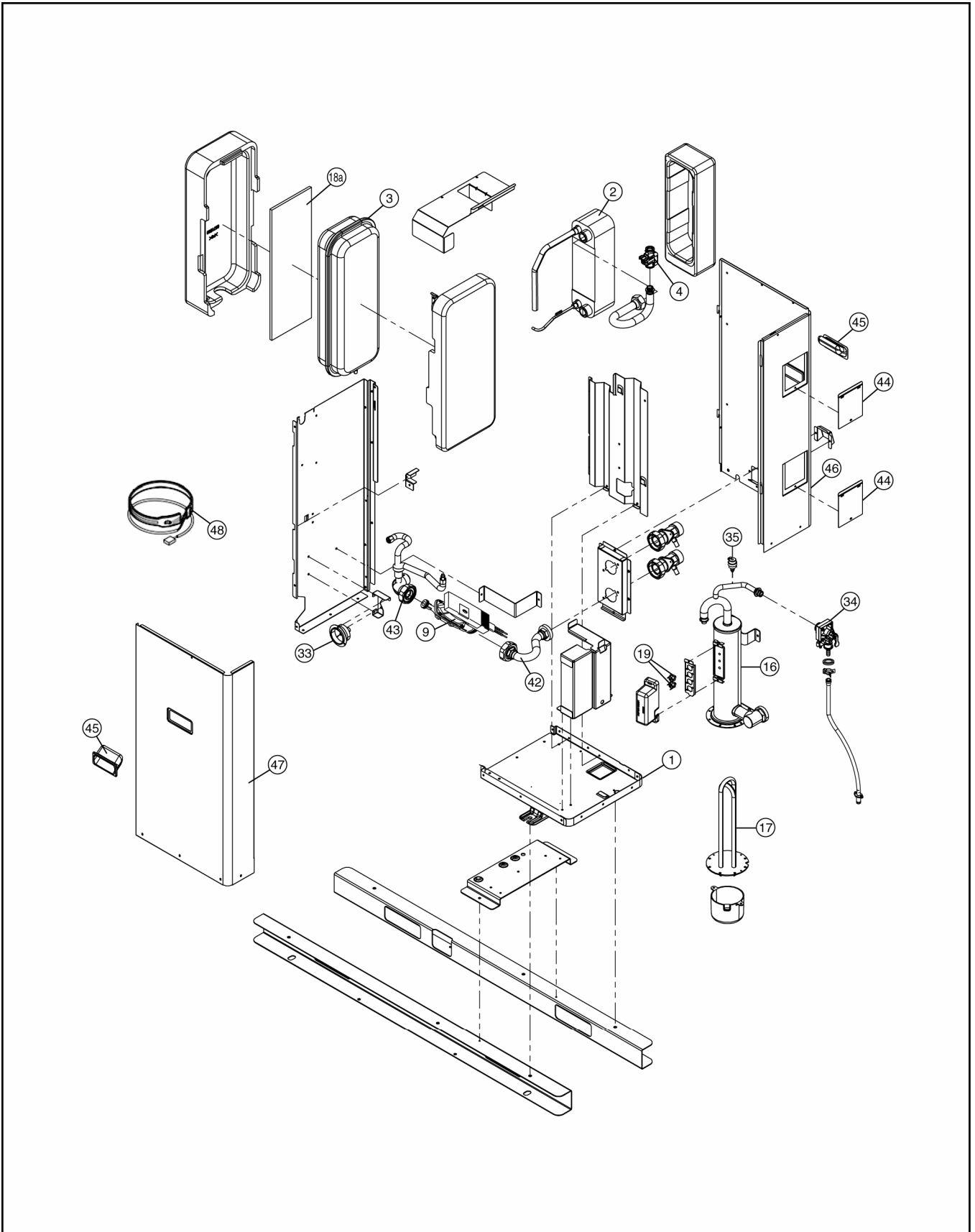

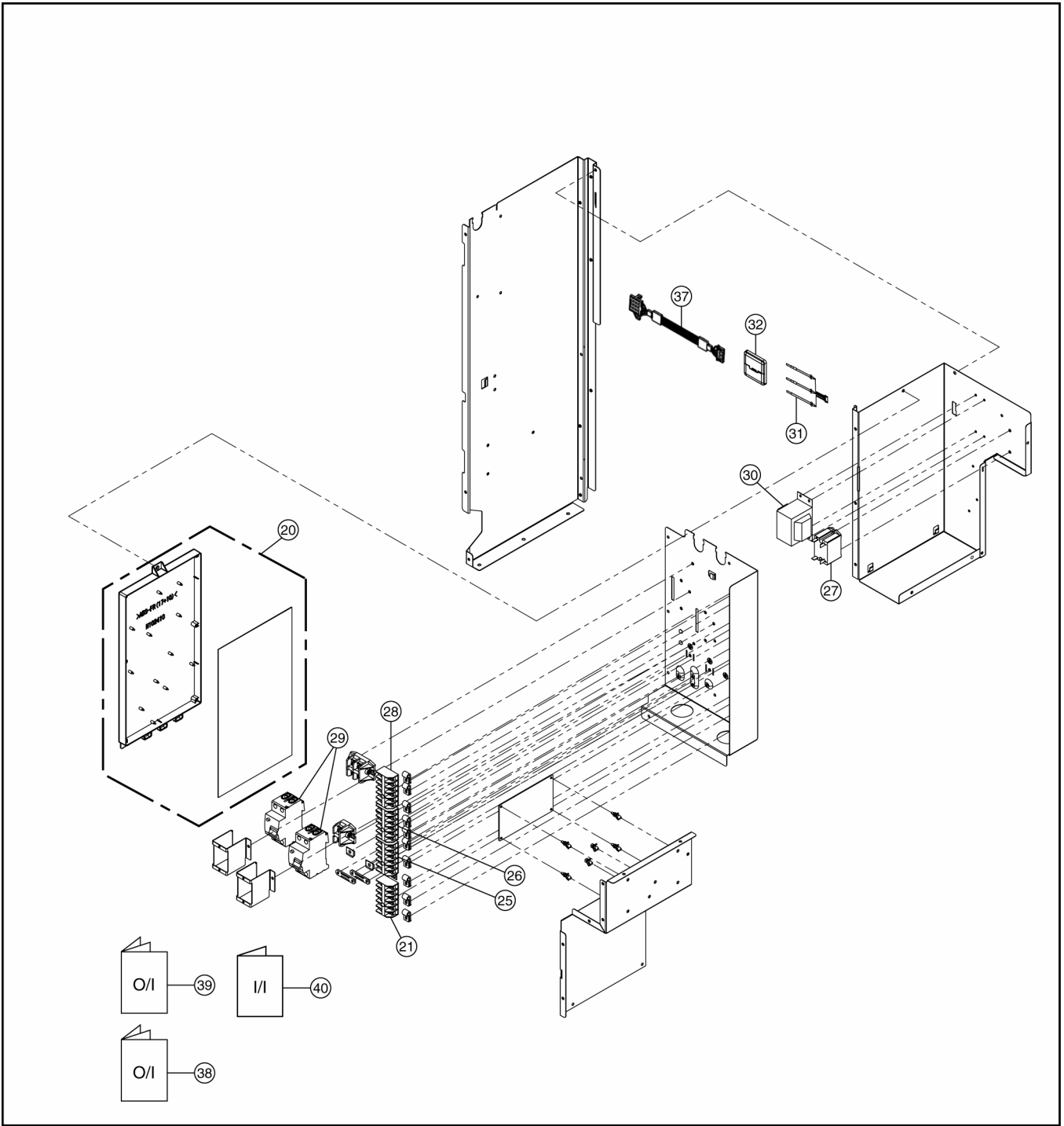

Note:

- The above exploded view is for the purpose of parts disassembly and replacement.
- The non-numbered parts are not kept as standard service parts.

< Model: Water System >

REF. NO.	DESCRIPTION & NAME	QTY.	WH-MDF06E3E5	WH-MDF09E3E5	REMARK
1	BASE PAN ASS'Y	1	CWD52K1279	←	
2	HOT WATER COIL-COMPLETE	1	CWB90C1067	←	O
3	RECEIVER	1	CWB141066	←	
4	FLOW SWITCH	1	CWB621034	←	
9	PUMP	1	CWB532108	←	O
16	BOTTLE COMP.	1	CWH90C0035	←	
17	HEATER ASS'Y	1	CWA34K1026	←	
18a	SOUND PROOF MATERIAL	1	CWG302649	←	
19	THERMOSTAT	2	CWA151065	←	O
20	ELECTRONIC CONTROLLER (MAIN)	1	CWA73C7074R	CWA73C7075R	O
21	TERMINAL BOARD ASS'Y-VALVE	1	CWA28K1229	←	O
25	TERMINAL BOARD ASS'Y-RECEIVER	1	CWA28K1230	←	O
26	TERMINAL BOARD ASS'Y	1	CWA28K1231	←	O
27	MAGNET RELAYS	1	K6C1AYY00004	←	O
28	TERMINAL BOARD ASS'Y-SOLAR	1	CWA28K1232	←	O
29	CIRCUIT BREAKER	2	CWA181005	←	O
30	TRANSFORMER-COMPLETE	1	CWA40C1096	←	O
31	SENSOR-COMPLETE	1	CWA50C2816	←	O
32	REMOTE CONTROL COMPLETE	1	CWA75C4024	←	O
33	PRESSURE GAUGE	1	CWB070001	←	O
34	PRESSURE RELIEF VALVE	1	CWB621092	←	
35	PRESSURE RELIEF VALVE	1	CWB621094	←	
37	REMOTE CONTROL CABLE	1	CWA221090	←	
38	OPERATING INSTRUCTION	1	CWF568869	←	
39	OPERATING INSTRUCTION	1	CWF568870	←	
40	INSTALLATION INSTRUCTION	1	CWF615590	←	
42	TUBE CONNECTOR-COMPLETE	1	CWT029061	←	
43	TUBE CONNECTOR-COMPLETE	1	CWT01C6323	←	
44	CONTROL BOARD COVER	2	CWH131420A	←	
45	HANDLE	2	CWE161008	←	
46	CABINET SIDE PLATE ASS'Y	1	CWE041665A	←	
47	CABINET FRONT PLATE	1	CWE061293A	←	
48	HEATER	1	CWA341071	←	

Note:

- All parts are supplied from PAPAMY, Malaysia (Vendor Code: 00029488).
- "O" marked parts are recommended to be kept in stock.