

Service Manual

Air-to-Water Hydromodule + Tank

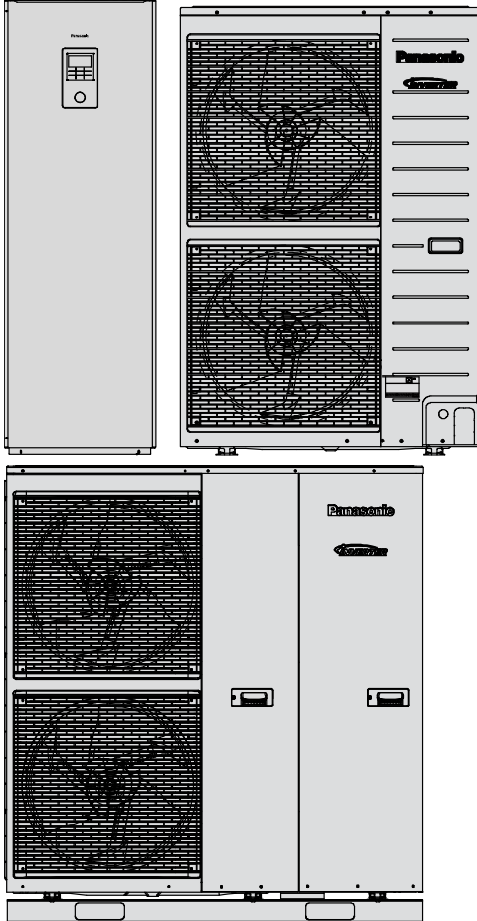

Indoor Unit
WH-ADC0916H9E8

Outdoor Unit
WH-UD09HE8
WH-UD12HE8
WH-UD16HE8
WH-UX09HE8
WH-UX12HE8
WH-UX16HE8
WH-UQ09HE8
WH-UQ12HE8
WH-UQ16HE8

Destination
Europe

WARNING

This service information is designed for experienced repair technicians only and is not designed for use by the general public. It does not contain warnings or cautions to advise non-technical individuals of potential dangers in attempting to service a product. Products powered by electricity should be serviced or repaired only by experienced professional technicians. Any attempt to service or repair the products dealt with in this service information by anyone else could result in serious injury or death.

IMPORTANT SAFETY NOTICE

There are special components used in this equipment which are important for safety. These parts are marked by  in the Schematic Diagrams, Circuit Board Diagrams, Exploded Views and Replacement Parts List. It is essential that these critical parts should be replaced with manufacturer's specified parts to prevent shock, fire or other hazards. Do not modify the original design without permission of manufacturer.

PRECAUTION OF LOW TEMPERATURE

In order to avoid frostbite, be assured of no refrigerant leakage during the installation or repairing of refrigerant circuit.



TABLE OF CONTENTS

1. Safety Precautions	4	11.8 Base Pan Heater Control (Optional)	101
2. Specifications	6	11.9 Heater Turn ON/OFF priority Control	101
2.1 WH-ADC0916H9E8 WH-UQ09HE8	6	11.10 Force Heater Mode	101
2.2 WH-ADC0916H9E8 WH-UQ12HE8	10	11.11 Powerful Operation	103
2.3 WH-ADC0916H9E8 WH-UQ16HE8	14	11.12 Quiet Operation	104
2.4 WH-ADC0916H9E8 WH-UX09HE8	18	11.13 Sterilization Mode	104
2.5 WH-ADC0916H9E8 WH-UX12HE8	22	11.14 Outdoor Ambient Thermo OFF Control ...	105
2.6 WH-ADC0916H9E8 WH-UX16HE8	26	11.15 Alternative Outdoor Ambient Sensor	
2.7 WH-ADC0916H9E8 WH-UD09HE8	30	Control	105
2.8 WH-ADC0916H9E8 WH-UD12HE8	34	11.16 Force DHW mode	105
2.9 WH-ADC0916H9E8 WH-UD16HE8	38	11.17 SMART DHW mode	106
3. Features	42	11.18 Anti Freeze Control	106
4. Location of Controls and Components	43	11.19 Solar Operation (Optional)	107
4.1 Indoor Unit	43	11.20 Boiler Bivalent Control	108
4.2 Outdoor Unit	61	11.21 External Room Thermostat Control	
5. Dimensions	62	(Optional)	110
5.1 Indoor Unit	62	11.22 Three Ways Valve Control	111
5.2 Outdoor Unit	63	11.23 Two Ways Valve Control	112
6. Refrigeration and Water Cycle Diagram	65	11.24 External OFF/ON Control	112
6.1 WH-ADC0916H9E8		11.25 External Compressor Switch	
WH-UX09/12/16HE8		(Optional PCB)	113
WH-ADC0916H9E8		11.26 Heat/Cool Switch (Optional PCB)	114
WH-UQ09/12/16HE8	65	11.27 SG Ready Control (Optional PCB)	114
6.2 WH-ADC0916H9E8		11.28 Demand Control (Optional PCB)	116
WH-UD09/12/16HE8	65	11.29 Holiday Mode	116
7. Block Diagram	66	11.30 Dry Concrete	117
7.1 WH-ADC0916H9E8 WH-UQ09HE8		11.31 Flow Sensor	117
WH-ADC0916H9E8 WH-UQ12HE8		12. Protection Control (WH-UQ09HE8,	
WH-ADC0916H9E8 WH-UX09HE8		WH-UQ12HE8 and WH-UQ16HE8)	118
WH-ADC0916H9E8 WH-UX12HE8	66	12.1 Protection Control for All Operations	118
7.2 WH-ADC0916H9E8 WH-UQ16HE8		12.2 Protection Control for Heating	
WH-ADC0916H9E8 WH-UX16HE8	67	Operation	120
7.3 WH-ADC0916H9E8 WH-UD09HE8		12.3 Protection Control for Cooling	
WH-ADC0916H9E8 WH-UD12HE8		Operation	122
WH-ADC0916H9E8 WH-UD16HE8	68	13. Protection Control (WH-UX09HE8,	
8. Wiring Connection Diagram	69	WH-UX12HE8 and WH-UX16HE8)	123
8.1 Indoor Unit	69	13.1 Protection Control for All Operations	123
8.2 Outdoor Unit	70	13.2 Protection Control for Heating	
9. Electronic Circuit Diagram	73	Operation	125
9.1 Indoor Unit	73	13.3 Protection Control for Cooling	
9.2 Outdoor Unit	74	Operation	127
10. Printed Circuit Board	77	14. Protection Control (WH-UD09HE8,	
10.1 Indoor Unit	77	WH-UD12HE8 and WH-UD16HE8)	128
10.2 Outdoor Unit	79	14.1 Protection Control for All Operations	128
11. Operation and Control	83	14.2 Protection Control for Heating	
11.1 Basic Function	83	Operation	130
11.2 Water Pump	94	14.3 Protection Control for Cooling	
11.3 Indoor Unit Safety	97	Operation	131
11.4 Auto Restart Control	97	15. Servicing Guide	132
11.5 Indication Panel	97	15.1 How to take out Front Plate	132
11.6 Indoor Back-Up Heater Control	98	15.2 Test Run	132
11.7 Tank Heater Control	99	15.3 Expansion Vessel Pre Pressure	
		Checking	132
		15.4 Pump Down Procedures	133
		15.5 How To Adjust Pump Speed	134
		15.6 How To Unlock Cool Mode	135



15.7	EEPROM Factory Default Data Setup Procedure	136
15.8	Dry Concrete Setup	137
16.	Maintenance Guide	139
16.1	Maintenance for Water Filter Set.....	141
17.	Troubleshooting Guide.....	143
17.1	Refrigeration Cycle System	143
17.2	Relationship between the Condition of the Air-to-Water Hydromodule + Tank and Air-to-Water Heatpump Outdoor Units and Pressure and Electric Current	144
17.3	Breakdown Self Diagnosis Function.....	145
17.4	Error Codes Table	147
17.5	Self-diagnosis Method	149
18.	Disassembly and Assembly Instructions	197
18.1	To Remove Front Plate and Top Plate.....	197
18.2	To Remove Pressure Gauge.....	198
18.3	To Remove Remote Control.....	198
18.4	To Remove RCCB.....	199
18.5	To Remove Electronic Controller.....	199
18.6	To Remove Flow Switch and Air Purge Valve.....	200
18.7	To Remove Water Pump	200
18.8	To Remove Bottle Complete	201
18.9	To Remove Water Filter	201
19.	Technical Data	202
19.1	Operation Characteristics	202
19.2	Heating Capacity Table	246
19.3	Cooling Capacity Table	249
20.	Exploded View and Replacement Parts List	251
20.1	Indoor Unit	251
20.2	Outdoor Unit	254

1. Safety Precautions











- Read the following “SAFETY PRECAUTIONS” carefully before installation of Air-To-Water Hydromodule + Tank (here after referred to as “Tank Unit”).
- Electrical works and water installation works must be done by licensed electrician and licensed water system installer respectively. Be sure to use the correct rating and main circuit for the model to be installed.
- The caution items stated here must be followed because these important contents are related to safety. The meaning of each indication used is as below.
Incorrect installation due to ignorance or negligence of the instructions will cause harm or damage, and the seriousness is classified by the following indications.
- Please leave this installation manual with the unit after installation.

 WARNING	This indication shows the possibility of causing death or serious injury.
 CAUTION	This indication shows the possibility of causing injury or damage to properties only.

- The items to be followed are classified by the symbols:

	Symbol with white background denotes item that is PROHIBITED from doing.
 	Symbol with dark background denotes item that must be carried out.

- Carry out test run to confirm that no abnormality occurs after the installation. Then, explain to user the operation, care and maintenance as stated in instructions. Please remind the customer to keep the operating instructions for future reference.
- If there is any doubt about the installation procedure or operation, always contact the authorized dealer for advice and information.

 WARNING	
1.	Do not use unspecified cord, modified cord, joint cord or extension cord for power supply cord. Do not share the single outlet with other electrical appliances. Poor contact, poor insulation or over current will cause electrical shock or fire. 
2.	Do not tie up the power supply cord into a bundle by band. Abnormal temperature rise on power supply cord may happen. 
3.	Keep plastic bag (packaging material) away from small children, it may cling to nose and mouth and prevent breathing. 
4.	Do not use pipe wrench to install refrigerant piping. It might deform the piping and cause the unit to malfunction. 
5.	Do not purchase unauthorized electrical parts for installation, service, maintenance and etc.. They might cause electrical shock or fire. 
6.	Do not add or replace refrigerant other than specified type. It may cause product damage, burst and injury etc. 
7.	Do not use the hot water produced by the Tank Unit for drinking or food preparation. It may cause illness to the user. 
8.	Do not place containers with liquids on top of the Tank Unit. It may cause Tank Unit damage and/or fire could occurs if they leak or spill onto the Tank Unit. 
9.	Do not use joint cable for Tank Unit / Outdoor Unit connection cable. Use specified Tank Unit / Outdoor Unit connection cable, refer to instruction CONNECT THE CABLE TO THE TANK UNIT and connect tightly for Tank Unit / Outdoor Unit connection. Clamp the cable so that no external force will be acted on the terminal. If connection or fixing is not perfect, it will cause heat up or fire at the connection. 
10.	For electrical work, follow local wiring standard, regulation and this installation instruction. An independent circuit and single outlet must be used. If electrical circuit capacity is not enough or defect found in electrical work, it will cause electrical shock or fire.
11.	For water circuit installation work, follow to relevant European and national regulations (including EN61770) and local plumbing and building regulation codes.
12.	Engage dealer or specialist for installation. If installation done by the user is defective, it will cause water leakage, electrical shock or fire.
13.	This is a R410A model, when connecting the piping, do not use any existing (R22) pipes and flare nuts. Using such same may cause abnormally high pressure in the refrigeration cycle (piping), and possibly result in explosion and injury. Use only R410A refrigerant. Thickness for copper pipes used with R410A must be 0.8 mm or more. It is desirable that the amount of residual oil is less than 40 mg/10 m.
14.	When install or relocate Tank Unit, do not let any substance other than the specified refrigerant, eg. air etc mix into refrigerant cycle (piping). Mixing of air etc. will cause abnormal high pressure in refrigeration cycle and result in explosion, injury etc.
15.	Install according to this installation instructions strictly. If installation is defective, it will cause water leakage, electrical shock or fire.
16.	Install at a strong and firm location which is able to withstand the set's weight. If the strength is not enough or installation is not properly done, the set will drop and cause injury.
17.	This equipment is strongly recommended to be installed with Residual Current Device (RCD) on-site according to the respective national wiring rules or country-specific safety measures in terms of residual current.

 **WARNING**

18.	During installation, install the refrigerant piping properly before run the compressor. Operation of compressor without fixing refrigeration piping and valves at opened condition will cause suck-in of air, abnormal high pressure in refrigeration cycle and result in explosion, injury etc.
19.	During pump down operation, stop the compressor before remove the refrigeration piping. Removal of refrigerant piping while compressor is operating and valves are opened will cause suck-in of air, abnormal high pressure in refrigerant cycle and result in explosion, injury etc.
20.	Tighten the flare nut with torque wrench according to specified method. If the flare nut is over tightened, after a long period, the flare may break and cause refrigerant gas leakage.
21.	After completion of installation, confirm there is no leakage of refrigerant gas. It may generate toxic gas when the refrigerant contacts with fire.
22.	Ventilate the room if there is refrigerant gas leakage during operation. Extinguish all fire sources if present. It may cause toxic gas when the refrigerant contacts with fire.
23.	Only use the supplied or specified installation parts, else, it may causes unit vibrate loose, water leakage, electrical shock or fire.
24.	If there is any doubt about the installation procedure or operation, always contact the authorized dealer for advice and information.
25.	Select a location where in case of water leakage, the leakage will not cause damage to other properties.
26.	When installing electrical equipment at wooden building of metal lath or wire lath, in accordance with electrical facility standard, no electrical contact between equipment and building is allowed. Insulator must be installed in between.
27.	Any work carried out on the Tank Unit after removing any panels which is secured by screws, must be carried out under the supervision of authorized dealer and licensed installation contractor.
28.	This system is multi supply appliance. All circuits must be disconnected before accessing the unit terminals.
29.	For cold water supply has a backflow regulator, check valve or water meter with check valve, provisions for thermal expansion of water in the hot water system must be provided. Otherwise it will cause water leakage.
30.	The piping installation work must be flushed before Tank Unit is connected to remove contaminants. Contaminants may damage the Tank Unit components.
31.	This installation may be subjected to building regulation approval applicable to respective country that may require to notify the local authority before installation.
32.	The Tank Unit must be shipped and stored in upright condition and dry environment. It may laid on its back when being moved into the building.
33.	Work done to the Tank Unit after remove the front plate cover that secured by screws, must be carried out under the supervision of authorized dealer, licensed installation contractor, skilled person and instructed person.
34.	This unit must be properly earthed. The electrical earth must not be connected to a gas pipe, water pipe, the earth of lightning rod or a telephone. Otherwise there is a danger of electrical shock in the event of an insulation breakdown or electrical earth fault in the Tank Unit.

 **CAUTION**

1.	Do not install the Tank Unit at place where leakage of flammable gas may occur. In case gas leaks and accumulates at surrounding of the unit, it may cause fire.	⊘
2.	Do not release refrigerant during piping work for installation, re-installation and during repairing a refrigeration parts. Take care of the liquid refrigerant, it may cause frostbite.	⊘
3.	Do not install this appliance in a laundry room or other high humidity location. This condition will cause rust and damage to the unit.	⊘
4.	Make sure the insulation of power supply cord does not contact hot part (i.e. refrigerant piping, water piping) to prevent from insulation failure (melt).	⊘
5.	Do not apply excessive force to water pipes that may damage the pipes. If water leakage occurs, it will cause flooding and damage to other properties.	⊘
6.	Do not transport the Tank Unit with water inside the unit. It may cause damage to the unit.	⊘
7.	Carry out drainage piping as mentioned in installation instructions. If drainage is not perfect, water may enter the room and damage the furniture.	
8.	Select an installation location which is easy for maintenance.	
9.	<p>Power supply connection to Tank Unit.</p> <ul style="list-style-type: none"> • Power supply point should be in easily accessible place for power disconnection in case of emergency. • Must follow local national wiring standard, regulation and this installation instruction. • Strongly recommended to make permanent connection to a circuit breaker. <ul style="list-style-type: none"> - Power Supply 1: Use approved 20A 4-poles circuit breaker with a minimum contact gap of 3.0mm. - Power Supply 2: Use approved 20A 4-poles circuit breaker with a minimum contact gap of 3.0mm. 	
10.	Ensure the correct polarity is maintained throughout all wiring. Otherwise, it will cause electrical shock or fire.	
11.	After installation, check the water leakage condition in connection area during test run. If leakage occurs, it will cause damage to other properties.	
12.	If the Tank Unit not operates for long time, the water inside the Tank Unit should be drained.	
13.	<p>Installation work.</p> <p>It may need three or more people to carry out the installation work. The weight of Tank Unit might cause injury if carried by one person.</p>	

2. Specifications

2.1 WH-ADC0916H9E8 WH-UQ09HE8

Item		Unit	Outdoor Unit		
Performance Test Condition			EN 14511		
Cooling Capacity	Condition (Ambient/Water)		A35W7		
	kW		7		
	BTU/h		23900		
	kcal/h		6020		
Cooling EER	W/W		3.17		
	kcal/h		2.72		
Heating Capacity	Condition (Ambient/Water)		A7W35	A2W35	
	kW		9.00	9.00	
	BTU/h		30700	30700	
	kcal/h		7740	7740	
Heating COP	W/W		4.84	3.59	
	kcal/h		4.16	3.08	
Heating ErP	Low temperature Application (W35)				
	Application	Climate	Warmer	Average	Colder
	Pdesign	kW	8.0	9.0	11.0
	Tbivalent / TOL	°C	2/2	-10/-10	-15/-22
	SCOP / ns	(W/W) / %	5.95/235	4.59/181	4.08/160
	Annual Consumption	kWh	2020	4049	6651
	Class		A++	A++	A++
	Low temperature Application (W55)				
	Application	Climate	Warmer	Average	Colder
	Pdesign	kW	9.0	9.0	11.0
	Tbivalent / TOL	°C	2/2	-10/-10	-15/-22
	SCOP / ns	(W/W) / %	4.02/158	3.32/130	3.20/125
	Annual Consumption	kWh	2991	5596	8468
	Class		A++	A++	A++
Noise Level	Condition (Ambient/Water)		A35W7	A7W35	A2W35
	dB(A)		Cooling: 48	Heating: 47	-
	Power level dB		Cooling: 63	Heating: 61	-
Air Flow	m ³ /min (ft ³ /min)		Cooling: 89.5 (3160) Heating: (76.8 (2710))		
Refrigerant Control Device			Expansion Valve		
Refrigerant Oil	cm ³		FV50S (1200)		
Refrigerant (R410A)	kg (oz)		2.85 (100.6)		
F-GAS	GWP		2088		
	CO ₂ eq (ton) (Precharged / Maximum)		5.951 / 8.039		
Dimension	Height	mm (inch)	1410 (55-1/2)		
	Width	mm (inch)	1283 (50-1/2)		
	Depth	mm (inch)	320 (12-19/32)		

Item		Unit	Outdoor Unit		
Net Weight		kg (lbs)	151 (333)		
Pipe Diameter	Liquid	mm (inch)	9.52 (3/8)		
	Gas	mm (inch)	15.88 (5/8)		
Standard Length		m (ft)	5 (16.4)		
Pipe Length Range		m (ft)	3 (9.8) ~ 30 (98.4)		
I/D & O/D Height Different		m (ft)	20 (65.6)		
Additional Gas Amount		g/m (oz/ft)	50 (0.5)		
Refrigerant Chargeless		m (ft)	10 (32.8)		
Compressor	Type		Hermetic Motor		
	Motor Type		Brushless (4-poles)		
	Rated Output	kW	4.30		
Fan	Type		Propeller Fan		
	Material		PP		
	Motor Type		DC (8-poles)		
	Input Power	W	-		
	Output Power	W	60		
	Fan Speed	rpm	Cooling: 550 (Top), 590 (Bottom) Heating: 490 (Top), 530 (Bottom)		
Heat Exchanger	Fin Material		Aluminium (Pre Coat)		
	Fin Type		Corrugated Fin		
	Row x Stage x FPI		2 x 51 x 18		
	Size (W x H X L)	mm	903.7 x 1295.4 x 38.1		
Power Source (Phase, Voltage, Cycle)		Ø	Three		
		V	400		
		Hz	50		
Input Power		Condition (Ambient/Water)	A35W7	A7W35	A2W35
		kW	Cooling: 2.21	Heating: 1.86	Heating: 2.51
Maximum Input Power for Heatpump System		kW	6.85		
Power Supply 1 : Phase (Ø) / Max. Current (A) / Max. Input Power (W)			3Ø / 10.4 / 6.85k		
Power Supply 2 : Phase (Ø) / Max. Current (A) / Max. Input Power (W)			3Ø / 13.0 / 9.00k		
Power Supply 3 : Phase (Ø) / Max. Current (A) / Max. Input Power (W)			- / - / -		
Starting current		A	3.4		
Running Current		Condition (Ambient/Water)	A35W7	A7W35	A2W35
		A	Cooling: 3.4	Heating: 2.8	Heating: 3.8
Maximum Current for Heatpump System		A	10.4		
Power Factor Power factor means total figure of compressor and outdoor fan motor.		%	Cooling: 96 Heating: 95		
Power Cord	Number of core		-		
	Length	m (ft)	-		
Thermostat			Electronic Control		
Protection Device			Electronic Control		

Item		Unit	Indoor Unit		
Performance Test Condition			EN14511		
Operation Range	Outdoor Ambient	°C (min. / max.)	Cooling: 16 / 43 Heating: -28 / 35		
	Water Outlet	°C (min. / max.)	Cooling: 5 - 20 Heating (Tank): - / 65* Heating Circuit: 20 / 55 (Below ambient -15°C), 20 / 60 (Below ambient -10°C)		
Internal Pressure Differential		kPa	Cooling: 15.0 Heating: 23.0		
Noise Level		Condition (Ambient/Water)	A35W7	A7W35	A2W35
		dB(A)	Cooling: 33	Heating: 33	-
		Power level dB	Cooling: 46	Heating: 46	-
Dimension	Height	mm (inch)	717 (28-7/32)		
	Width	mm (inch)	598 (23-17/32)		
	Depth	mm (inch)	1800 (70-27/32)		
Net Weight		kg (lbs)	126 (278)		
Refrigerant Pipe Diameter	Liquid	mm (inch)	9.52 (3/8)		
	Gas	mm (inch)	15.88 (5/8)		
Water Pipe Diameter	Room	mm (inch)	31 (1-1/4)		
	Shower	mm (inch)	19 (3/4)		
Water Drain Hose Inner Diameter		mm (inch)	12.10 (17/36)		
Pump	Motor Type		DC Motor		
	Input Power	W	52		
Hot Water Coil	Type		Brazed Plate		
	No. of Plates		52		
	Size (H x W x L)	mm	93 x 119 x 376		
	Water Flow Rate	l/min (m³/h)	Cooling: 20.1 (1.2) Heating: 25.8 (1.5)		
Pressure Relief Valve Water Circuit		kPa	Open: 300, Close: 266 and below		
Flow Switch	Type		Electronic Sensor		
Protection Device		A	Residual Current Circuit Breaker (25)		
Expansion Vessel	Volume	l	10		
	MWP	bar	3		
Capacity of Integrated Electric Heater / OLP TEMP		kW / °C	9.00 / 80		
Tank Volume (Spec / Nett)		L	200 / 185		
Max. Tank Water Set Temperature		°C	65		
Tank Coil Surface		m²	1.8		
Maximum Working Pressure	Heat / Cool	bar	3.0		
	Tank Circuit	bar	8.0		
Operating Pressure	Tank Unit	bar	3.5		
	Expansion Relief Valve	bar	8.0		
Expansion Vessel Pre-Charge Pressure (DHW Circuit)		bar	3.5		
Pressure Reducing Valve Set Pressure (DHW Circuit)		bar	3.5		

Item		Unit	Indoor Unit
Pressure Vessel	Material		EN-1.4521
	Volume	L	185
	Design Pressure	bar	10
Heat Exchanger	Material		EN-1.4162 / EN-1.4521
	Diameter	mm	22
	Thickness	mm	0.8
	Surface Area	m ²	1.8
	Total Length	m	25

Note:

- Cooling capacities are based on outdoor air temperature of 35°C Dry Bulb with controlled indoor water inlet temperature of 12°C and water outlet temperature of 7°C.
- Heating capacities are based on outdoor air temperature of 7°C Dry Bulb (44.6°F Dry Bulb), 6°C Wet Bulb (42.8°F Wet Bulb) with controlled indoor water inlet temperature of 30°C and water outlet temperature of 35°C.
- Specifications are subjected to change without prior notice for further improvement.
- * Above 55°C, only possible with backup heater operation.

2.2 WH-ADC0916H9E8 WH-UQ12HE8

Item		Unit	Outdoor Unit			
Performance Test Condition			EN 14511			
Cooling Capacity	Condition (Ambient/Water)		A35W7			
	kW		10.00			
	BTU/h		34100			
	kcal/h		8600			
Cooling EER	W/W		2.81			
	kcal/h		2.42			
Heating Capacity	Condition (Ambient/Water)		A7W35	A2W35		
	kW		12.00	12.00		
	BTU/h		41000	41000		
	kcal/h		10320	10320		
Heating COP	W/W		4.74	3.44		
	kcal/h		4.08	2.96		
Heating ErP	Low temperature Application (W35)					
	Application	Climate	Warmer	Average	Colder	
	Pdesign	kW	12.00	12.00	14.00	
	Tbivalent / TOL	°C	2/2	-10/-10	-15/-22	
	SCOP / ns	(W/W) / %	5.86 / 231	4.32 / 170	4.08 / 160	
	Annual Consumption	kWh	2738	5745	8480	
	Class		A++	A++	A++	
	Low temperature Application (W55)					
	Application	Climate	Warmer	Average	Colder	
	Pdesign	kW	12.00	12.00	13.00	
	Tbivalent / TOL	°C	2 / 2	-10 / -10	-15 / -22	
	SCOP / ns	(W/W) / %	4.02 / 158	3.32 / 130	3.20 / 125	
	Annual Consumption	kWh	3990	7466	10012	
	Class		A++	A++	A++	
	Noise Level	Condition (Ambient/Water)		A35W7	A7W35	A2W35
		dB(A)		Cooling: 49	Heating: 48	-
Power level dB			Cooling: 64	Heating: 62	-	
Air Flow	m³/min (ft³/min)		Cooling: 93.3 (3290) Heating: 80.0 (2830)			
Refrigerant Control Device			Expansion Valve			
Refrigerant Oil	cm³		FV50S (1200)			
Refrigerant (R410A)	kg (oz)		2.85k (100.6)			
F-GAS	GWP		2088			
	CO2eq (ton) (Precharged / Maximum)		6.243 / 8.331			
Dimension	Height	mm (inch)	1410 (55-1/2)			
	Width	mm (inch)	1283 (50-1/2)			
	Depth	mm (inch)	320 (12-19/32)			

Item		Unit	Outdoor Unit		
Net Weight		kg (lbs)	151 (333)		
Pipe Diameter	Liquid	mm (inch)	9.52 (3/8)		
	Gas	mm (inch)	15.88 (5/8)		
Standard Length		m (ft)	5 (16.4)		
Pipe Length Range		m (ft)	3 (9.8) ~ 30 (98.4)		
I/D & O/D Height Different		m (ft)	20 (65.6)		
Additional Gas Amount		g/m (oz/ft)	50 (0.5)		
Refrigerant Chargeless		m (ft)	10 (32.8)		
Compressor	Type		Hermetic Motor		
	Motor Type		Brushless (4-poles)		
	Rated Output	kW	4.30		
Fan	Type		Propeller Fan		
	Material		PP		
	Motor Type		DC (8-poles)		
	Input Power	W	-		
	Output Power	W	60		
	Fan Speed	rpm	Cooling: 600 (Top), 640 (Bottom) Heating: 520 (Top), 560 (Bottom)		
Heat Exchanger	Fin Material		Aluminium (Pre Coat)		
	Fin Type		Corrugated Fin		
	Row x Stage x FPI		2 x 51 x 18		
	Size (W x H X L)	mm	903.7 x 1295.4 x 38.1		
Power Source (Phase, Voltage, Cycle)		Ø	Three		
		V	400		
		Hz	50		
Input Power		Condition (Ambient/Water)	A35W7	A7W35	A2W35
		kW	Cooling: 3.56	Heating: 2.53	Heating: 3.49
Maximum Input Power for Heatpump System		kW	7.91		
Power Supply 1 : Phase (Ø) / Max. Current (A) / Max. Input Power (W)			3Ø / 11.9 / 7.91k		
Power Supply 2 : Phase (Ø) / Max. Current (A) / Max. Input Power (W)			3Ø / 13.0 / 9.00k		
Power Supply 3 : Phase (Ø) / Max. Current (A) / Max. Input Power (W)			- / - / -		
Starting current		A	5.4		
Running Current		Condition (Ambient/Water)	A35W7	A7W35	A2W35
		A	Cooling: 5.4	Heating: 3.9	Heating: 5.3
Maximum Current for Heatpump System		A	11.9		
Power Factor Power factor means total figure of compressor and outdoor fan motor.		%	Cooling: 97	Heating: 96	Heating: 5.3
Power Cord	Number of core		-		
	Length	m (ft)	-		
Thermostat			Electronic Control		
Protection Device			Electronic Control		

Item		Unit	Indoor Unit		
Performance Test Condition			EN 14511		
Operation Range	Outdoor Ambient	°C (min. / max.)	Cooling: 16/43 Heating: -28 / 35		
	Water Outlet	°C (min. / max.)	Cooling: 5 / 20 Heating (Tank): - / 65*, Heating (Circuit): 20 / 55 (Below ambient -15°C), 20 / 60 (Below ambient -10°C)		
Internal Pressure Differential		kPa	Cooling: 28.0 Heating: 39.0		
Noise Level		Condition (Ambient/Water)	A35W7	A7W35	A2W35
		dB(A)	Cooling: 33	Heating: 33	-
		Power level dB	Cooling: 46	Heating: 46	-
Dimension	Height	mm (inch)	717 (28-7/32)		
	Width	mm (inch)	598 (23-17/32)		
	Depth	mm (inch)	1800 (70-27/32)		
Net Weight		kg (lbs)	126 (278)		
Refrigerant Pipe Diameter	Liquid	mm (inch)	9.52 (3/8)		
	Gas	mm (inch)	15.88 (5/8)		
Water Pipe Diameter	Room	mm (inch)	31 (1-1/4)		
	Shower	mm (inch)	19 (3/4)		
Water Drain Hose Inner Diameter		mm (inch)	12.10 (17/36)		
Pump	Motor Type		DC Motor		
	Input Power	W	82		
Hot Water Coil	Type		Brazed Plate		
	No. of Plates		52		
	Size (H x W x L)	mm	93 x 119 x 376		
	Water Flow Rate	l/min (m³/h)	Cooling: 28.7 (1.7) Heating: 34.4 (2.1)		
Pressure Relief Valve Water Circuit		kPa	Open: 300, Close: 266 and below		
Flow Switch	Type		Electronic sensor		
Protection Device		A	Residual Current Circuit Breaker (25)		
Expansion Vessel	Volume	l	10		
	MWP	bar	3		
Capacity of Integrated Electric Heater / OLP TEMP		kW / °C	9.00 / 80		
Tank Volume (Spec / Nett)		L	200 / 185		
Max. Tank Water Set Temperature		°C	65		
Tank Coil Surface		m²	1.8		
Maximum Working Pressure	Heat / Cool	bar	3.0		
	Tank Circuit	bar	8.0		
Operating Pressure	Tank Unit	bar	3.5		
	Expansion Relief Valve	bar	8.0		
Expansion Vessel Pre-Charge Pressure (DHW Circuit)		bar	3.5		
Pressure Reducing Valve Set Pressure (DHW Circuit)		bar	3.5		

Item		Unit	Indoor Unit
Pressure Vessel	Material		EN-1.4521
	Volume	L	185
	Design Pressure	bar	10
Heat Exchanger	Material		EN-1.4162 / EN-1.4521
	Diameter	mm	22
	Thickness	mm	0.8
	Surface Area	m ²	1.8
	Total Length	m	25

Note:

- Cooling capacities are based on outdoor air temperature of 35°C Dry Bulb with controlled indoor water inlet temperature of 12°C and water outlet temperature of 7°C.
- Heating capacities are based on outdoor air temperature of 7°C Dry Bulb (44.6°F Dry Bulb), 6°C Wet Bulb (42.8°F Wet Bulb) with controlled indoor water inlet temperature of 30°C and water outlet temperature of 35°C.
- Specifications are subjected to change without prior notice for further improvement.
- * Above 55°C, only possible with backup heater operation.

2.3 WH-ADC0916H9E8 WH-UQ16HE8

Item		Unit	Outdoor Unit			
Performance Test Condition			EN 14511			
Cooling Capacity	Condition (Ambient/Water)		A35W7			
	kW		12.20			
	BTU/h		41600			
	kcal/h		10490			
Cooling EER	W/W		2.57			
	kcal/h		2.20			
Heating Capacity	Condition (Ambient/Water)		A7W35	A2W35		
	kW		16.00	16.00		
	BTU/h		54600	54600		
	kcal/h		13760	13760		
Heating COP	W/W		4.28	3.10		
	kcal/h		3.68	2.67		
Heating ErP	Low temperature Application (W35)					
	Application	Climate	Warmer	Average	Colder	
	Pdesign	kW	16.0	16.0	19.0	
	Tbivalent / TOL	°C	2/2	-10 / -10	-15 / -22	
	SCOP / ns	(W/W) / %	5.86 / 231	4.08 / 160	3.83 / 150	
	Annual Consumption	kWh	3650	8107	12233	
	Class		A++	A++	A++	
	Low temperature Application (W55)					
	Application	Climate	Warmer	Average	Colder	
	Pdesign	kW	16.0	16.0	18.0	
	Tbivalent / TOL	°C	2 / 2	-10 / -10	-15 / -22	
	SCOP / ns	(W/W) / %	4.05 / 159	3.20 / 125	3.20 / 125	
	Annual Consumption	kWh	5280	10330	13870	
	Class		A++	A++	A++	
	Noise Level	Condition (Ambient/Water)		A35W7	A7W35	A2W35
		dB(A)		Cooling: 53	Heating: 51	-
Power level dB			Cooling: 68	Heating: 65	-	
Air Flow	m³/min (ft³/min)		Cooling: 109.4 (3860) Heating: 76.0 (2680)			
Refrigerant Control Device			Expansion Valve			
Refrigerant Oil	cm³		FV50S (1200)			
Refrigerant (R410A)	kg (oz)		2.99 (105.5)			
F-GAS	GWP		2088			
	CO2eq (ton) (Precharged / Maximum)		6.243 / 8.331			
Dimension	Height	mm (inch)	1410 (55-1/2)			
	Width	mm (inch)	1283 (50-1/2)			
	Depth	mm (inch)	320 (12-19/32)			

Item		Unit	Outdoor Unit		
Net Weight		kg (lbs)	161 (355)		
Pipe Diameter	Liquid	mm (inch)	9.52 (3/8)		
	Gas	mm (inch)	15.88 (5/8)		
Standard Length		m (ft)	5 (16.4)		
Pipe Length Range		m (ft)	3 (9.8) ~ 30 (98.4)		
I/D & O/D Height Different		m (ft)	20 (65.6)		
Additional Gas Amount		g/m (oz/ft)	50 (0.5)		
Refrigerant Chargeless		m (ft)	10 (32.8)		
Compressor	Type		Hermetic Motor		
	Motor Type		Brushless (4-poles)		
	Rated Output	kW	4.76		
Fan	Type		Propeller Fan		
	Material		PP		
	Motor Type		DC (8-poles)		
	Input Power	W	-		
	Output Power	W	60		
	Fan Speed	rpm	Cooling: 680 (Top), 720 (Bottom) Heating: 580 (Top), 620 (Bottom)		
Heat Exchanger	Fin Material		Aluminium (Pre Coat)		
	Fin Type		Corrugated Fin		
	Row x Stage x FPI		2 x 51 x 19		
	Size (W x H X L)	mm	898.8 x 1295.4 x 44		
Power Source (Phase, Voltage, Cycle)	Ø		Three		
	V		400		
	Hz		50		
Input Power	Condition (Ambient/Water)		A35W7	A7W35	A2W35
	kW		Cooling: 4.76	Heating: 3.74	Heating: 5.16
Maximum Input Power for Heatpump System		kW	10.27		
Power Supply 1 : Phase (Ø) / Max. Current (A) / Max. Input Power (W)			3Ø / 15.5 / 10.27k		
Power Supply 2 : Phase (Ø) / Max. Current (A) / Max. Input Power (W)			3Ø / 13.0 / 9.00k		
Power Supply 3 : Phase (Ø) / Max. Current (A) / Max. Input Power (W)			- / - / -		
Starting current		A	7.2		
Running Current	Condition (Ambient/Water)		A35W7	A7W35	A2W35
	A		Cooling: 7.2	Heating: 5.7	Heating: 7.8
Maximum Current for Heatpump System		A	15.5		
Power Factor Power factor means total figure of compressor and outdoor fan motor.		%	Cooling: 96	Heating: 96	Heating: 96
Power Cord	Number of core		-		
	Length	m (ft)	-		
Thermostat			Electronic Control		
Protection Device			Electronic Control		

Item		Unit	Indoor Unit		
Performance Test Condition			EN 14511		
Operation Range	Outdoor Ambient	°C (min. / max.)	Cooling: 16 / 43 Heating: -28 / 35		
	Water Outlet	°C (min. / max.)	Cooling: 5 / 20 Heating (Tank): - / 65* Heating (Circuit): 20 / 55 (Below ambient -15°C) 20 / 60 (Below ambient -10°C)		
Internal Pressure Differential		kPa	Cooling: 40.0 Heating: 69.0		
Noise Level	Condition (Ambient/Water)	dB(A)	A35W7	A7W35	A2W35
			Cooling: 33	Heating: 33	-
			Cooling: 46	Heating: 46	-
Dimension	Height	mm (inch)	717 (28-7/32)		
	Width	mm (inch)	598 (23-17/32)		
	Depth	mm (inch)	1800 (70-27/32)		
Net Weight		kg (lbs)	126 (278)		
Refrigerant Pipe Diameter	Liquid	mm (inch)	9.52 (3/8)		
	Gas	mm (inch)	15.88 (5/8)		
Water Pipe Diameter	Room	mm (inch)	31 (1-1/4)		
	Shower	mm (inch)	19 (3/4)		
Water Drain Hose Inner Diameter		mm (inch)	12.10 (17/38)		
Pump	Motor Type		DC Motor		
	Input Power	W	132		
Hot Water Coil	Type		Brazen Plate		
	No. of Plates		52		
	Size (H x W x L)	mm	93 x 119 x 376		
	Water Flow Rate	l/min (m³/h)	Cooling: 35.0 (2.1) Heating: 45.9 (2.8)		
Pressure Relief Valve Water Circuit		kPa	Open: 300, Close: 266 and below		
Flow Switch	Type		Electronic Sensor		
Protection Device		A	Residual Current Circuit Breaker (25)		
Expansion Vessel	Volume	l	10		
	MWP	bar	3		
Capacity of Integrated Electric Heater / OLP TEMP		kW / °C	9.00 / 80		
Tank Volume (Spec / Nett)		L	200 / 185		
Max. Tank Water Set Temperature		°C	65		
Tank Coil Surface		m²	1.8		
Maximum Working Pressure	Heat / Cool	bar	3.0		
	Tank Circuit	bar	8.0		
Operating Pressure	Tank Unit	bar	3.5		
	Expansion Relief Valve	bar	8.0		
Expansion Vessel Pre-Charge Pressure (DHW Circuit)		bar	3.5		
Pressure Reducing Valve Set Pressure (DHW Circuit)		bar	3.5		

Item		Unit	Indoor Unit
Pressure Vessel	Material		EN-1.4521
	Volume	L	185
	Design Pressure	bar	10
Heat Exchanger	Material		EN-1.4162 / EN-1.4521
	Diameter	mm	22
	Thickness	mm	0.8
	Surface Area	m ²	1.8
	Total Length	m	25

Note:

- Cooling capacities are based on outdoor air temperature of 35°C Dry Bulb with controlled indoor water inlet temperature of 12°C and water outlet temperature of 7°C.
- Heating capacities are based on outdoor air temperature of 7°C Dry Bulb (44.6°F Dry Bulb), 6°C Wet Bulb (42.8°F Wet Bulb) with controlled indoor water inlet temperature of 30°C and water outlet temperature of 35°C.
- Specifications are subjected to change without prior notice for further improvement.
- * Above 55°C, only possible with backup heater operation.

2.4 WH-ADC0916H9E8 WH-UX09HE8

Item		Unit	Outdoor Unit			
Performance Test Condition			EN 14511			
Cooling Capacity	Condition (Ambient/Water)		A35W7			
	kW		7.00			
	BTU/h		23900			
	kcal/h		6020			
Cooling EER	W/W		3.17			
	kcal/h		2.72			
Heating Capacity	Condition (Ambient/Water)		A7W35	A2W35		
	kW		9.00	9.00		
	BTU/h		30700	30700		
	kcal/h		7740	7740		
Heating COP	W/W		4.84	3.59		
	kcal/h		4.16	3.08		
Heating ErP	Low temperature Application (W35)					
	Application	Climate	Warmer	Average	Colder	
	Pdesign	kW	9.0	9.0	11.0	
	Tbivalent / TOL	°C	2 / 2	-10 / -10	-15 / -22	
	SCOP / ns	(W/W) / %	5.95 / 235	4.59 / 181	4.08 / 160	
	Annual Consumption	kWh	2020	4049	6651	
	Class		A++	A++	A++	
	Low temperature Application (W55)					
	Application	Climate	Warmer	Average	Colder	
	Pdesign	kW	9.0	9.0	11.0	
	Tbivalent / TOL	°C	2 / 2	-10 / -10	-15 / -22	
	SCOP / ns	(W/W) / %	4.02 / 158	3.32 / 130	3.20 / 125	
	Annual Consumption	kWh	2991	5596	8468	
	Class		A++	A++	A++	
	Noise Level	Condition (Ambient/Water)		A35W7	A7W35	A2W35
		dB(A)		Cooling: 49	Heating: 51	-
Power level dB			Cooling: 67	Heating: 68	-	
Air Flow	m ³ /min (ft ³ /min)		Cooling: 89.5 (3160) Heating: (76.8 (2710))			
Refrigerant Control Device			Expansion Valve			
Refrigerant Oil	cm ³		FV50S (1200)			
Refrigerant (R410A)	kg (oz)		2.85 (100.6)			
F-GAS	GWP		2088			
	CO ₂ eq (ton) (Precharged / Maximum)		5.951 / 8.039			
Dimension	Height	mm (inch)	1340 (52-3/4)			
	Width	mm (inch)	900 (35-7/16)			
	Depth	mm (inch)	320 (12-19/32)			

Item		Unit	Outdoor Unit		
Net Weight		kg (lbs)	108 (238)		
Pipe Diameter	Liquid	mm (inch)	9.52 (3/8)		
	Gas	mm (inch)	15.88 (5/8)		
Standard Length		m (ft)	5 (16.4)		
Pipe Length Range		m (ft)	3 (9.8) ~ 30 (98.4)		
I/D & O/D Height Different		m (ft)	20 (65.6)		
Additional Gas Amount		g/m (oz/ft)	50 (0.5)		
Refrigerant Chargeless		m (ft)	10 (32.8)		
Compressor	Type		Hermetic Motor		
	Motor Type		Brushless (4-poles)		
	Rated Output	kW	4.30		
Fan	Type		Propeller Fan		
	Material		PP		
	Motor Type		DC (8-poles)		
	Input Power	W	-		
	Output Power	W	60		
	Fan Speed	rpm	Cooling: 550 (Top), 590 (Bottom) Heating: 490 (Top), 530 (Bottom)		
Heat Exchanger	Fin Material		Aluminium (Pre Coat)		
	Fin Type		Corrugated Fin		
	Row x Stage x FPI		2 x 51 x 18		
	Size (W x H X L)	mm	903.7 x 1295.4 x 38.1		
Power Source (Phase, Voltage, Cycle)	Ø		Three		
	V		400		
	Hz		50		
Input Power	Condition (Ambient/Water)		A35W7	A7W35	A2W35
	kW		Cooling: 2.21	Heating: 1.86	Heating: 2.51
Maximum Input Power for Heatpump System		kW	6.85		
Power Supply 1 : Phase (Ø) / Max. Current (A) / Max. Input Power (W)			3Ø / 10.4 / 6.85k		
Power Supply 2 : Phase (Ø) / Max. Current (A) / Max. Input Power (W)			3Ø / 13.0 / 9.00k		
Power Supply 3 : Phase (Ø) / Max. Current (A) / Max. Input Power (W)			- / - / -		
Starting current		A	3.4		
Running Current	Condition (Ambient/Water)		A35W7	A7W35	A2W35
	A		Cooling: 3.4	Heating: 2.8	Heating: 3.8
Maximum Current for Heatpump System		A	10.4		
Power Factor Power factor means total figure of compressor and outdoor fan motor.		%	Cooling: 96 Heating: 95		
Power Cord	Number of core		-		
	Length	m (ft)	-		
Thermostat			Electronic Control		
Protection Device			Electronic Control		

Item		Unit	Indoor Unit		
Performance Test Condition			EN14511		
Operation Range	Outdoor Ambient	°C (min. / max.)	Cooling: 16 / 43 Heating: -28 / 35		
	Water Outlet	°C (min. / max.)	Cooling: 5 - 20 Heating (Tank): - / 65* Heating Circuit: 20 / 55 (Below ambient -15°C), 20 / 60 (Below ambient -10°C)		
Internal Pressure Differential		kPa	Cooling: 15.0 Heating: 23.0		
Noise Level	Condition (Ambient/Water)		A35W7	A7W35	A2W35
	dB(A)		Cooling: 33	Heating: 33	-
	Power level dB		Cooling: 46	Heating: 46	-
Dimension	Height	mm (inch)	717 (28-7/32)		
	Width	mm (inch)	FV50S (
	Depth	mm (inch)	1800 (70-27/32)		
Net Weight		kg (lbs)	126 (278)		
Refrigerant Pipe Diameter	Liquid	mm (inch)	9.52 (3/8)		
	Gas	mm (inch)	15.88 (5/8)		
Water Pipe Diameter	Room	mm (inch)	31 (1-1/4)		
	Shower	mm (inch)	19 (3/4)		
Water Drain Hose Inner Diameter		mm (inch)	12.10 (17/36)		
Pump	Motor Type		DC Motor		
	Input Power	W	52		
Hot Water Coil	Type		Brazed Plate		
	No. of Plates		52		
	Size (H x W x L)	mm	93 x 119 x 376		
	Water Flow Rate	l/min (m³/h)	Cooling: 20.1 (1.2) Heating: 25.8 (1.5)		
Pressure Relief Valve Water Circuit		kPa	Open: 300, Close: 266 and below		
Flow Switch	Type		Electronic Sensor		
Protection Device		A	Residual Current Circuit Breaker (25)		
Expansion Vessel	Volume	l	10		
	MWP	bar	3		
Capacity of Integrated Electric Heater / OLP TEMP		kW / °C	9.00 / 80		
Tank Volume (Spec / Nett)		L	200 / 185		
Max. Tank Water Set Temperature		°C	65		
Tank Coil Surface		m²	1.8		
Maximum Working Pressure	Heat / Cool	bar	3.0		
	Tank Circuit	bar	8.0		
Operating Pressure	Tank Unit	bar	3.5		
	Expansion Relief Valve	bar	8.0		
Expansion Vessel Pre-Charge Pressure (DHW Circuit)		bar	3.5		
Pressure Reducing Valve Set Pressure (DHW Circuit)		bar	3.5		

Item		Unit	Indoor Unit
Pressure Vessel	Material		EN-1.4521
	Volume	L	185
	Design Pressure	bar	10
Heat Exchanger	Material		EN-1.4162 / EN-1.4521
	Diameter	mm	22
	Thickness	mm	0.8
	Surface Area	m ²	1.8
	Total Length	m	25

Note:

- Cooling capacities are based on outdoor air temperature of 35°C Dry Bulb with controlled indoor water inlet temperature of 12°C and water outlet temperature of 7°C.
- Heating capacities are based on outdoor air temperature of 7°C Dry Bulb (44.6°F Dry Bulb), 6°C Wet Bulb (42.8°F Wet Bulb) with controlled indoor water inlet temperature of 30°C and water outlet temperature of 35°C.
- Specifications are subjected to change without prior notice for further improvement.
- * Above 55°C, only possible with backup heater operation.

2.5 WH-ADC0916H9E8 WH-UX12HE8

Item		Unit	Outdoor Unit			
Performance Test Condition			EN 14511			
Cooling Capacity	Condition (Ambient/Water)		A35W7			
	kW		10.00			
	BTU/h		34100			
	kcal/h		8600			
Cooling EER	W/W		2.81			
	kcal/h		2.42			
Heating Capacity	Condition (Ambient/Water)		A7W35	A2W35		
	kW		12.00	12.00		
	BTU/h		41000	41000		
	kcal/h		10320	10320		
Heating COP	W/W		4.74	3.44		
	kcal/h		4.08	2.96		
Heating ErP	Low temperature Application (W35)					
	Application	Climate	Warmer	Average	Colder	
	Pdesign	kW	12.00	12.00	14.00	
	Tbivalent / TOL	°C	2 / 2	-10 / -10	-15 / -22	
	SCOP / ns	(W/W) / %	5.86 / 231	4.32 / 170	4.08 / 160	
	Annual Consumption	kWh	2738	5745	8460	
	Class		A++	A++	A++	
	Low temperature Application (W55)					
	Application	Climate	Warmer	Average	Colder	
	Pdesign	kW	12.00	12.00	13.00	
	Tbivalent / TOL	°C	2 / 2	-10 / -10	-15 / -22	
	SCOP / ns	(W/W) / %	4.08 / 158	3.32 / 130	3.20 / 125	
	Annual Consumption	kWh	3990	7466	10012	
	Class		A++	A++	A++	
	Noise Level	Condition (Ambient/Water)		A35W7	A7W35	A2W35
		dB(A)		Cooling: 50	Heating: 52	-
Power level dB			Cooling: 68	Heating: 69	-	
Air Flow	m³/min (ft³/min)		Cooling: 93.3 (3290) Heating: 80.0 (2830)			
Refrigerant Control Device			Expansion Valve			
Refrigerant Oil	cm³		FV50S (1200)			
Refrigerant (R410A)	kg (oz)		2.85k (100.6)			
F-GAS	GWP		2088			
	CO2eq (ton) (Precharged / Maximum)		5.951 / 8.039			
Dimension	Height	mm (inch)	1340 (52-3/4)			
	Width	mm (inch)	900 (35-7/16)			
	Depth	mm (inch)	320 (12-19/32)			

Item		Unit	Outdoor Unit		
Net Weight		kg (lbs)	108 (238)		
Pipe Diameter	Liquid	mm (inch)	9.52 (3/8)		
	Gas	mm (inch)	15.88 (5/8)		
Standard Length		m (ft)	5 (16.4)		
Pipe Length Range		m (ft)	3 (9.8) ~ 30 (98.4)		
I/D & O/D Height Different		m (ft)	20 (65.6)		
Additional Gas Amount		g/m (oz/ft)	50 (0.5)		
Refrigerant Chargeless		m (ft)	10 (32.8)		
Compressor	Type		Hermetic Motor		
	Motor Type		Brushless (4-poles)		
	Rated Output	kW	4.30		
Fan	Type		Propeller Fan		
	Material		PP		
	Motor Type		DC (8-poles)		
	Input Power	W	-		
	Output Power	W	60		
	Fan Speed	rpm	Cooling: 600 (Top), 640 (Bottom) Heating: 520 (Top), 560 (Bottom)		
Heat Exchanger	Fin Material		Aluminium (Pre Coat)		
	Fin Type		Corrugated Fin		
	Row x Stage x FPI		2 x 51 x 18		
	Size (W x H X L)	mm	903.7 x 1295.4 x 38.1		
Power Source (Phase, Voltage, Cycle)		Ø	Three		
		V	400		
		Hz	50		
Input Power		Condition (Ambient/Water)	A35W7	A7W35	A2W35
		kW	Cooling: 3.56	Heating: 2.53	Heating: 3.49
Maximum Input Power for Heatpump System		kW	7.91		
Power Supply 1 : Phase (Ø) / Max. Current (A) / Max. Input Power (W)			3Ø / 11.9 / 7.91k		
Power Supply 2 : Phase (Ø) / Max. Current (A) / Max. Input Power (W)			3Ø / 13.0 / 9.00k		
Power Supply 3 : Phase (Ø) / Max. Current (A) / Max. Input Power (W)			- / - / -		
Starting current		A	5.4		
Running Current		Condition (Ambient/Water)	A35W7	A7W35	A2W35
		A	Cooling: 5.4	Heating: 3.9	Heating: 5.3
Maximum Current for Heatpump System		A	11.9		
Power Factor Power factor means total figure of compressor and outdoor fan motor.		%	Cooling: 97	Heating: 96	Heating: 97
Power Cord	Number of core		-		
	Length	m (ft)	-		
Thermostat			Electronic Control		
Protection Device			Electronic Control		

Item		Unit	Indoor Unit		
Performance Test Condition			EN 14511		
Operation Range	Outdoor Ambient	°C (min. / max.)	Cooling: 16/43 Heating: -28 / 35		
	Water Outlet	°C (min. / max.)	Cooling: 5 / 20 Heating (Tank): - / 65*, Heating (Circuit): 20 / 55 (Below ambient -15°C), 20 / 60 (Below ambient -10°C)		
Internal Pressure Differential		kPa	Cooling: 28.0 Heating: 39.0		
Noise Level		Condition (Ambient/Water)	A35W7	A7W35	A2W35
		dB(A)	Cooling: 33	Heating: 33	-
		Power level dB	Cooling: 46	Heating: 46	-
Dimension	Height	mm (inch)	717 (28-7/32)		
	Width	mm (inch)	598 (23-17/32)		
	Depth	mm (inch)	1800 (70-27/32)		
Net Weight		kg (lbs)	126 (278)		
Refrigerant Pipe Diameter	Liquid	mm (inch)	9.52 (3/8)		
	Gas	mm (inch)	15.88 (5/8)		
Water Pipe Diameter	Room	mm (inch)	31 (1-1/4)		
	Shower	mm (inch)	19 (3/4)		
Water Drain Hose Inner Diameter		mm (inch)	12.10 (17/36)		
Pump	Motor Type		DC Motor		
	Input Power	W	82		
Hot Water Coil	Type		Brazed Plate		
	No. of Plates		52		
	Size (H x W x L)	mm	93 x 119 x 376		
	Water Flow Rate	l/min (m³/h)	Cooling: 28.7 (1.7) Heating: 34.4 (2.1)		
Pressure Relief Valve Water Circuit		kPa	Open: 300, Close: 266 and below		
Flow Switch	Type		Electronic sensor		
Protection Device		A	Residual Current Circuit Breaker (25)		
Expansion Vessel	Volume	l	10		
	MWP	bar	3		
Capacity of Integrated Electric Heater / OLP TEMP		kW / °C	9.00 / 80		
Tank Volume (Spec / Nett)		L	200 / 185		
Max. Tank Water Set Temperature		°C	65		
Tank Coil Surface		m²	1.8		
Maximum Working Pressure	Heat / Cool	bar	3.0		
	Tank Circuit	bar	8.0		
Operating Pressure	Tank Unit	bar	3.5		
	Expansion Relief Valve	bar	8.0		
Expansion Vessel Pre-Charge Pressure (DHW Circuit)		bar	3.5		
Pressure Reducing Valve Set Pressure (DHW Circuit)		bar	3.5		

Item		Unit	Indoor Unit
Pressure Vessel	Material		EN-1.4521
	Volume	L	185
	Design Pressure	bar	10
Heat Exchanger	Material		EN-1.4162 / EN-1.4521
	Diameter	mm	22
	Thickness	mm	0.8
	Surface Area	m ²	1.8
	Total Length	m	25

Note:

- Cooling capacities are based on outdoor air temperature of 35°C Dry Bulb with controlled indoor water inlet temperature of 12°C and water outlet temperature of 7°C.
- Heating capacities are based on outdoor air temperature of 7°C Dry Bulb (44.6°F Dry Bulb), 6°C Wet Bulb (42.8°F Wet Bulb) with controlled indoor water inlet temperature of 30°C and water outlet temperature of 35°C.
- Specifications are subjected to change without prior notice for further improvement.
- * Above 55°C, only possible with backup heater operation.

2.6 WH-ADC0916H9E8 WH-UX16HE8

Item		Unit	Outdoor Unit			
Performance Test Condition			EN 14511			
Cooling Capacity	Condition (Ambient/Water)		A35W7			
	kW		12.20			
	BTU/h		41600			
	kcal/h		10490			
Cooling EER	W/W		2.57			
	kcal/h		2.20			
Heating Capacity	Condition (Ambient/Water)		A7W35	A2W35		
	kW		16.00	16.00		
	BTU/h		54600	54600		
	kcal/h		13760	13760		
Heating COP	W/W		4.28	3.10		
	kcal/h		3.68	2.67		
Heating ErP	Low temperature Application (W35)					
	Application	Climate	Warmer	Average	Colder	
	Pdesign	kW	16.0	16.0	19.0	
	Tbivalent / TOL	°C	2 / 2	-10 / -10	-15 / -22	
	SCOP / ns	(W/W) / %	5.86 / 231	4.08 / 160	3.83 / 150	
	Annual Consumption	kWh	3650	8107	12233	
	Class		A++	A++	A++	
	Low temperature Application (W55)					
	Application	Climate	Warmer	Average	Colder	
	Pdesign	kW	16.0	16.0	18.0	
	Tbivalent / TOL	°C	2 / 2	-10 / -10	-15 / -22	
	SCOP / ns	(W/W) / %	4.05 / 159	3.20 / 125	3.20 / 125	
	Annual Consumption	kWh	5280	10330	13870	
	Class		A++	A++	A++	
	Noise Level	Condition (Ambient/Water)		A35W7	A7W35	A2W35
		dB(A)		Cooling: 54	Heating: 55	-
Power level dB			Cooling: 71	Heating: 72	-	
Air Flow	m³/min (ft³/min)		Cooling: 109.4 (3860) Heating: 76.0 (2680)			
Refrigerant Control Device			Expansion Valve			
Refrigerant Oil	cm³		FV50S (1200)			
Refrigerant (R410A)	kg (oz)		2.90 (102.4)			
F-GAS	GWP		2088			
	CO2eq (ton) (Precharged / Maximum)		6.055 / 8.143			
Dimension	Height	mm (inch)	1340 (52-3/4)			
	Width	mm (inch)	900 (35-7/16)			
	Depth	mm (inch)	320 (12-19/32)			

Item		Unit	Outdoor Unit		
Net Weight		kg (lbs)	118 (260)		
Pipe Diameter	Liquid	mm (inch)	9.52 (3/8)		
	Gas	mm (inch)	15.88 (5/8)		
Standard Length		m (ft)	5 (16.4)		
Pipe Length Range		m (ft)	3 (9.8) ~ 30 (98.4)		
I/D & O/D Height Different		m (ft)	20 (65.6)		
Additional Gas Amount		g/m (oz/ft)	50 (0.5)		
Refrigerant Chargeless		m (ft)	10 (32.8)		
Compressor	Type		Hermetic Motor		
	Motor Type		Brushless (4-poles)		
	Rated Output	kW	4.76		
Fan	Type		Propeller Fan		
	Material		PP		
	Motor Type		DC (8-poles)		
	Input Power	W	-		
	Output Power	W	60		
	Fan Speed	rpm	Cooling: 680 (Top), 720 (Bottom) Heating: 580 (Top), 620 (Bottom)		
Heat Exchanger	Fin Material		Aluminium (Pre Coat)		
	Fin Type		Corrugated Fin		
	Row x Stage x FPI		2 x 51 x 19		
	Size (W x H X L)	mm	898.8 x 1295.4 x 44		
Power Source (Phase, Voltage, Cycle)		∅	Three		
		V	400		
		Hz	50		
Input Power		Condition (Ambient/Water)	A35W7	A7W35	A2W35
		kW	Cooling: 4.76	Heating: 3.74	Heating: 5.16
Maximum Input Power for Heatpump System		kW	10.27		
Power Supply 1 : Phase (∅) / Max. Current (A) / Max. Input Power (W)			3∅ / 15.5 / 10.27k		
Power Supply 2 : Phase (∅) / Max. Current (A) / Max. Input Power (W)			3∅ / 13.0 / 9.00k		
Power Supply 3 : Phase (∅) / Max. Current (A) / Max. Input Power (W)			- / - / -		
Starting current		A	7.2		
Running Current		Condition (Ambient/Water)	A35W7	A7W35	A2W35
		A	Cooling: 7.2	Heating: 5.7	Heating: 7.8
Maximum Current for Heatpump System		A	15.5		
Power Factor Power factor means total figure of compressor and outdoor fan motor.		%	Cooling: 96	Heating: 96	Heating: 96
Power Cord	Number of core		-		
	Length	m (ft)	-		
Thermostat			Electronic Control		
Protection Device			Electronic Control		

Item		Unit	Indoor Unit		
Performance Test Condition			EN 14511		
Operation Range	Outdoor Ambient	°C (min. / max.)	Cooling: 16 / 43 Heating: -28 / 35		
	Water Outlet	°C (min. / max.)	Cooling: 5 / 20 Heating (Tank): - / 65* Heating (Circuit): 20 / 55 (Below ambient -15°C) 20 / 60 (Below ambient -10°C)		
Internal Pressure Differential		kPa	Cooling: 40.0 Heating: 69.0		
Noise Level	Condition (Ambient/Water)	dB(A)	A35W7	A7W35	A2W35
			Cooling: 33	Heating: 33	-
			Cooling: 46	Heating: 46	-
Dimension	Height	mm (inch)	717 (28-7/32)		
	Width	mm (inch)	598 (23-17/32)		
	Depth	mm (inch)	1800 (70-27/32)		
Net Weight		kg (lbs)	126 (278)		
Refrigerant Pipe Diameter	Liquid	mm (inch)	9.52 (3/8)		
	Gas	mm (inch)	15.88 (5/8)		
Water Pipe Diameter	Room	mm (inch)	31 (1-1/4)		
	Shower	mm (inch)	19 (3/4)		
Water Drain Hose Inner Diameter		mm (inch)	12.10 (17/38)		
Pump	Motor Type		DC Motor		
	Input Power	W	132		
Hot Water Coil	Type		Brazed Plate		
	No. of Plates		52		
	Size (H x W x L)	mm	93 x 119 x 376		
	Water Flow Rate	l/min (m³/h)	Cooling: 35.0 (2.1) Heating: 45.9 (2.8)		
Pressure Relief Valve Water Circuit		kPa	Open: 300, Close: 266 and below		
Flow Switch	Type		Electronic Sensor		
Protection Device		A	Residual Current Circuit Breaker (25)		
Expansion Vessel	Volume	l	10		
	MWP	bar	3		
Capacity of Integrated Electric Heater / OLP TEMP		kW / °C	9.00 / 80		
Tank Volume (Spec / Nett)		L	200 / 185		
Max. Tank Water Set Temperature		°C	65		
Tank Coil Surface		m²	1.8		
Maximum Working Pressure	Heat / Cool	bar	3.0		
	Tank Circuit	bar	8.0		
Operating Pressure	Tank Unit	bar	3.5		
	Expansion Relief Valve	bar	8.0		
Expansion Vessel Pre-Charge Pressure (DHW Circuit)		bar	3.5		
Pressure Reducing Valve Set Pressure (DHW Circuit)		bar	3.5		

Item		Unit	Indoor Unit
Pressure Vessel	Material		EN-1.4521
	Volume	L	185
	Design Pressure	bar	10
Heat Exchanger	Material		EN-1.4162 / EN-1.4521
	Diameter	mm	22
	Thickness	mm	0.8
	Surface Area	m ²	1.8
	Total Length	m	25

Note:

- Cooling capacities are based on outdoor air temperature of 35°C Dry Bulb with controlled indoor water inlet temperature of 12°C and water outlet temperature of 7°C.
- Heating capacities are based on outdoor air temperature of 7°C Dry Bulb (44.6°F Dry Bulb), 6°C Wet Bulb (42.8°F Wet Bulb) with controlled indoor water inlet temperature of 30°C and water outlet temperature of 35°C.
- Specifications are subjected to change without prior notice for further improvement.
- * Above 55°C, only possible with backup heater operation.

2.7 WH-ADC0916H9E8 WH-UD09HE8

Item		Unit	Outdoor Unit			
Performance Test Condition			EN 14511			
Cooling Capacity	Condition (Ambient/Water)		A35W7			
	kW		7.00			
	BTU/h		23900			
	kcal/h		6020			
Cooling EER	W/W		3.17			
	kcal/h		2.72			
Heating Capacity	Condition (Ambient/Water)		A7W35	A2W35		
	kW		9.00	9.00		
	BTU/h		30700	30700		
	kcal/h		7740	7740		
Heating COP	W/W		4.84	3.59		
	kcal/h		4.16	3.08		
Heating ErP	Low temperature Application (W35)					
	Application	Climate	Warmer	Average	Colder	
	Pdesign	kW	9.0	9.0	10.0	
	Tbivalent / TOL	°C	2 / 2	-10 / -10	-15 / -22	
	SCOP / ns	(W/W) / %	6.21 / 245	4.81 / 190	4.28 / 168	
	Annual Consumption	kWh	1936	3863	5757	
	Class		A++	A++	A++	
	Low temperature Application (W55)					
	Application	Climate	Warmer	Average	Colder	
	Pdesign	kW	9.0	8.0	8.0	
	Tbivalent / TOL	°C	2 / 2	-10 / -10	-15 / -22	
	SCOP / ns	(W/W) / %	4.05 / 159	3.41 / 133	3.10 / 121	
	Annual Consumption	kWh	2957	4844	6368	
	Class		A++	A++	A+	
	Noise Level	Condition (Ambient/Water)		A35W7	A7W35	A2W35
		dB(A)		Cooling: 49	Heating: 51	-
Power level dB			Cooling: 67	Heating: 68	-	
Air Flow	m ³ /min (ft ³ /min)		Cooling: 89.5 (3160) Heating: (76.8 (2710))			
Refrigerant Control Device			Expansion Valve			
Refrigerant Oil	cm ³		FV50S (1200)			
Refrigerant (R410A)	kg (oz)		2.55 (90.0)			
F-GAS	GWP		2088			
	CO ₂ eq (ton) (Precharged / Maximum)		5.324 / 7.412			
Dimension	Height	mm (inch)	1340 (52-3/4)			
	Width	mm (inch)	900 (35-7/16)			
	Depth	mm (inch)	320 (12-19/32)			

Item		Unit	Outdoor Unit		
Net Weight		kg (lbs)	107 (236)		
Pipe Diameter	Liquid	mm (inch)	9.52 (3/8)		
	Gas	mm (inch)	15.88 (5/8)		
Standard Length		m (ft)	5 (16.4)		
Pipe Length Range		m (ft)	3 (9.8) ~ 30 (98.4)		
I/D & O/D Height Different		m (ft)	20 (65.6)		
Additional Gas Amount		g/m (oz/ft)	50 (0.5)		
Refrigerant Chargeless		m (ft)	10 (32.8)		
Compressor	Type		Hermetic Motor		
	Motor Type		Brushless (4-poles)		
	Rated Output	kW	4.30		
Fan	Type		Propeller Fan		
	Material		PP		
	Motor Type		DC (8-poles)		
	Input Power	W	-		
	Output Power	W	60		
	Fan Speed	rpm	Cooling: 550 (Top), 590 (Bottom) Heating: 490 (Top), 530 (Bottom)		
Heat Exchanger	Fin Material		Aluminium (Pre Coat)		
	Fin Type		Corrugated Fin		
	Row x Stage x FPI		2 x 51 x 18		
	Size (W x H X L)	mm	903.7 x 1295.4 x 38.1		
Power Source (Phase, Voltage, Cycle)		Ø	Three		
		V	400		
		Hz	50		
Input Power		Condition (Ambient/Water)	A35W7	A7W35	A2W35
		kW	Cooling: 2.21	Heating: 1.86	Heating: 2.51
Maximum Input Power for Heatpump System		kW	5.85		
Power Supply 1 : Phase (Ø) / Max. Current (A) / Max. Input Power (W)			3Ø / 8.8 / 5.85k		
Power Supply 2 : Phase (Ø) / Max. Current (A) / Max. Input Power (W)			3Ø / 13.0 / 9.00k		
Power Supply 3 : Phase (Ø) / Max. Current (A) / Max. Input Power (W)			- / - / -		
Starting current		A	3.4		
Running Current		Condition (Ambient/Water)	A35W7	A7W35	A2W35
		A	Cooling: 3.4	Heating: 2.8	Heating: 3.8
Maximum Current for Heatpump System		A	8.8		
Power Factor Power factor means total figure of compressor and outdoor fan motor.		%	Cooling: 95	Heating: 95	Heating: 95
Power Cord	Number of core		-		
	Length	m (ft)	-		
Thermostat			Electronic Control		
Protection Device			Electronic Control		

Item		Unit	Indoor Unit		
Performance Test Condition			EN14511		
Operation Range	Outdoor Ambient	°C (min. / max.)	Cooling: 16 / 43 Heating: -20 / 35		
	Water Outlet	°C (min. / max.)	Cooling: 5 / 20 Heating (Tank): - / 65* Heating Circuit: 20 / 55		
Internal Pressure Differential		kPa	Cooling: 15.0 Heating: 23.0		
Noise Level		Condition (Ambient/Water)	A35W7	A7W35	A2W35
		dB(A)	Cooling: 33	Heating: 33	-
		Power level dB	Cooling: 46	Heating: 46	-
Dimension	Height	mm (inch)	717 (28-7/32)		
	Width	mm (inch)	598 (23-17/32)		
	Depth	mm (inch)	1800 (70-27/32)		
Net Weight		kg (lbs)	126 (278)		
Refrigerant Pipe Diameter	Liquid	mm (inch)	9.52 (3/8)		
	Gas	mm (inch)	15.88 (5/8)		
Water Pipe Diameter	Room	mm (inch)	31 (1-1/4)		
	Shower	mm (inch)	19 (3/4)		
Water Drain Hose Inner Diameter		mm (inch)	12.10 (17/36)		
Pump	Motor Type		DC Motor		
	Input Power	W	52		
Hot Water Coil	Type		Braze Plate		
	No. of Plates		52		
	Size (H x W x L)	mm	93 x 119 x 376		
	Water Flow Rate	l/min (m³/h)	Cooling: 20.1 (1.2) Heating: 25.8 (1.5)		
Pressure Relief Valve Water Circuit		kPa	Open: 300, Close: 266 and below		
Flow Switch	Type		Electronic Sensor		
Protection Device		A	Residual Current Circuit Breaker (25)		
Expansion Vessel	Volume	l	10		
	MWP	bar	3		
Capacity of Integrated Electric Heater / OLP TEMP		kW / °C	9.00 / 80		
Tank Volume (Spec / Nett)		L	200 / 185		
Max. Tank Water Set Temperature		°C	65		
Tank Coil Surface		m²	1.8		
Maximum Working Pressure	Heat / Cool	bar	3.0		
	Tank Circuit	bar	8.0		
Operating Pressure	Tank Unit	bar	3.5		
	Expansion Relief Valve	bar	8.0		
Expansion Vessel Pre-Charge Pressure (DHW Circuit)		bar	3.5		
Pressure Reducing Valve Set Pressure (DHW Circuit)		bar	3.5		

Item		Unit	Indoor Unit
Pressure Vessel	Material		EN-1.4521
	Volume	L	185
	Design Pressure	bar	10
Heat Exchanger	Material		EN-1.4162 / EN-1.4521
	Diameter	mm	22
	Thickness	mm	0.8
	Surface Area	m ²	1.8
	Total Length	m	25

Note:

- Cooling capacities are based on outdoor air temperature of 35°C Dry Bulb with controlled indoor water inlet temperature of 12°C and water outlet temperature of 7°C.
- Heating capacities are based on outdoor air temperature of 7°C Dry Bulb (44.6°F Dry Bulb), 6°C Wet Bulb (42.8°F Wet Bulb) with controlled indoor water inlet temperature of 30°C and water outlet temperature of 35°C.
- Specifications are subjected to change without prior notice for further improvement.
- * Above 55°C, only possible with backup heater operation.

2.8 WH-ADC0916H9E8 WH-UD12HE8

Item		Unit	Outdoor Unit		
Performance Test Condition			EN 14511		
Cooling Capacity	Condition (Ambient/Water)		A35W7		
	kW		10.00		
	BTU/h		34100		
	kcal/h		8600		
Cooling EER	W/W		2.85		
	kcal/h		2.45		
Heating Capacity	Condition (Ambient/Water)		A7W35	A2W35	
	kW		12.00	11.40	
	BTU/h		41000	38900	
	kcal/h		10320	9800	
Heating COP	W/W		4.74	3.44	
	kcal/h		4.08	2.96	
Heating ErP	Low temperature Application (W35)				
	Application	Climate	Warmer	Average	Colder
	Pdesign	kW	11.0	10.0	11.0
	Tbivalent / TOL	°C	2 / 2	-10 / -10	-15 / -22
	SCOP / ns	(W/W) / %	6.21 / 245	4.82 / 190	4.29 / 168
	Annual Consumption	kWh	2368	4286	6327
	Class		A++	A++	A++
	Low temperature Application (W55)				
	Application	Climate	Warmer	Average	Colder
	Pdesign	kW	9.0	8.0	9.0
	Tbivalent / TOL	°C	2 / 2	-10 / -10	-15 / -22
	SCOP / ns	(W/W) / %	4.05 / 159	3.42 / 134	3.10 / 121
	Annual Consumption	kWh	2970	4840	7147
	Class		A++	A++	A+
Noise Level	Condition (Ambient/Water)		A35W7	A7W35	A2W35
	dB(A)		Cooling: 50	Heating: 52	-
	Power level dB		Cooling: 68	Heating: 69	-
Air Flow	m³/min (ft³/min)		Cooling: 93.3 (3290) Heating: 80.0 (2830)		
Refrigerant Control Device			Expansion Valve		
Refrigerant Oil	cm³		FV50S (1200)		
Refrigerant (R410A)	kg (oz)		2.55 (90.0)		
F-GAS	GWP		2088		
	CO2eq (ton) (Precharged / Maximum)		5.324 / 7.412		
Dimension	Height	mm (inch)	1340 (52-3/4)		
	Width	mm (inch)	900 (35-7/16)		
	Depth	mm (inch)	320 (12-19/32)		

Item		Unit	Outdoor Unit		
Net Weight		kg (lbs)	107 (236)		
Pipe Diameter	Liquid	mm (inch)	9.52 (3/8)		
	Gas	mm (inch)	15.88 (5/8)		
Standard Length		m (ft)	5 (16.4)		
Pipe Length Range		m (ft)	3 (9.8) ~ 30 (98.4)		
I/D & O/D Height Different		m (ft)	20 (65.6)		
Additional Gas Amount		g/m (oz/ft)	50 (0.5)		
Refrigerant Chargeless		m (ft)	10 (32.8)		
Compressor	Type		Hermetic Motor		
	Motor Type		Brushless (4-poles)		
	Rated Output	kW	4.30		
Fan	Type		Propeller Fan		
	Material		PP		
	Motor Type		DC (8-poles)		
	Input Power	W	-		
	Output Power	W	60		
	Fan Speed	rpm	Cooling: 600 (Top), 640 (Bottom) Heating: 510 (Top), 550 (Bottom)		
Heat Exchanger	Fin Material		Aluminium (Pre Coat)		
	Fin Type		Corrugated Fin		
	Row x Stage x FPI		2 x 51 x 18		
	Size (W x H X L)	mm	903.7 x 1295.4 x 38.1		
Power Source (Phase, Voltage, Cycle)		∅	Three		
		V	400		
		Hz	50		
Input Power		Condition (Ambient/Water)	A35W7	A7W35	A2W35
		kW	Cooling: 3.51	Heating: 2.53	Heating: 3.31
Maximum Input Power for Heatpump System		kW	5.85		
Power Supply 1 : Phase (∅) / Max. Current (A) / Max. Input Power (W)			3∅ / 8.8 / 5.85k		
Power Supply 2 : Phase (∅) / Max. Current (A) / Max. Input Power (W)			3∅ / 13.0 / 9.00k		
Power Supply 3 : Phase (∅) / Max. Current (A) / Max. Input Power (W)			- / - / -		
Starting current		A	5.3		
Running Current		Condition (Ambient/Water)	A35W7	A7W35	A2W35
		A	Cooling: 5.3	Heating: 3.8	Heating: 5.0
Maximum Current for Heatpump System		A	8.8		
Power Factor Power factor means total figure of compressor and outdoor fan motor.		%	Cooling: 96	Heating: 96	Heating: 96
Power Cord	Number of core		-		
	Length	m (ft)	-		
Thermostat			Electronic Control		
Protection Device			Electronic Control		

Item		Unit	Indoor Unit		
Performance Test Condition			EN 14511		
Operation Range	Outdoor Ambient	°C (min. / max.)	Cooling: 16/43 Heating: -28 / 35		
	Water Outlet	°C (min. / max.)	Cooling: 5 / 20 Heating (Tank): - / 65*, Heating (Circuit): 20 / 55		
Internal Pressure Differential		kPa	Cooling: 28.0 Heating: 39.0		
Noise Level		Condition (Ambient/Water)	A35W7	A7W35	A2W35
		dB(A)	Cooling: 33	Heating: 33	-
		Power level dB	Cooling: 46	Heating: 46	-
Dimension	Height	mm (inch)	717 (28-7/32)		
	Width	mm (inch)	598 (23-17/32)		
	Depth	mm (inch)	1800 (70-27/32)		
Net Weight		kg (lbs)	126 (278)		
Refrigerant Pipe Diameter	Liquid	mm (inch)	9.52 (3/8)		
	Gas	mm (inch)	15.88 (5/8)		
Water Pipe Diameter	Room	mm (inch)	31 (1-1/4)		
	Shower	mm (inch)	19 (3/4)		
Water Drain Hose Inner Diameter		mm (inch)	12.10 (17/36)		
Pump	Motor Type		DC Motor		
	Input Power	W	82		
Hot Water Coil	Type		Brazed Plate		
	No. of Plates		52		
	Size (H x W x L)	mm	93 x 119 x 376		
	Water Flow Rate	l/min (m³/h)	Cooling: 28.7 (1.7) Heating: 34.4 (2.1)		
Pressure Relief Valve Water Circuit		kPa	Open: 300, Close: 266 and below		
Flow Switch	Type		Electronic sensor		
Protection Device		A	Residual Current Circuit Breaker (25)		
Expansion Vessel	Volume	l	10		
	MWP	bar	3		
Capacity of Integrated Electric Heater / OLP TEMP		kW / °C	9.00 / 80		
Tank Volume (Spec / Nett)		L	200 / 185		
Max. Tank Water Set Temperature		°C	65		
Tank Coil Surface		m²	1.8		
Maximum Working Pressure	Heat / Cool	bar	3.0		
	Tank Circuit	bar	8.0		
Operating Pressure	Tank Unit	bar	3.5		
	Expansion Relief Valve	bar	8.0		
Expansion Vessel Pre-Charge Pressure (DHW Circuit)		bar	3.5		
Pressure Reducing Valve Set Pressure (DHW Circuit)		bar	3.5		

Item		Unit	Indoor Unit
Pressure Vessel	Material		EN-1.4521
	Volume	L	185
	Design Pressure	bar	10
Heat Exchanger	Material		EN-1.4162 / EN-1.4521
	Diameter	mm	22
	Thickness	mm	0.8
	Surface Area	m ²	1.8
	Total Length	m	25

Note:

- Cooling capacities are based on outdoor air temperature of 35°C Dry Bulb with controlled indoor water inlet temperature of 12°C and water outlet temperature of 7°C.
- Heating capacities are based on outdoor air temperature of 7°C Dry Bulb (44.6°F Dry Bulb), 6°C Wet Bulb (42.8°F Wet Bulb) with controlled indoor water inlet temperature of 30°C and water outlet temperature of 35°C.
- Specifications are subjected to change without prior notice for further improvement.
- * Above 55°C, only possible with backup heater operation.

2.9 WH-ADC0916H9E8 WH-UD16HE8

Item		Unit	Outdoor Unit			
Performance Test Condition			EN 14511			
Cooling Capacity	Condition (Ambient/Water)		A35W7			
	kW		12.20			
	BTU/h		41600			
	kcal/h		10490			
Cooling EER	W/W		2.56			
	kcal/h		2.20			
Heating Capacity	Condition (Ambient/Water)		A7W35	A2W35		
	kW		16.00	13.00		
	BTU/h		54600	44300		
	kcal/h		13760	11180		
Heating COP	W/W		4.28	3.28		
	kcal/h		3.68	2.82		
Heating ErP	Low temperature Application (W35)					
	Application	Climate	Warmer	Average	Colder	
	Pdesign	kW	13.0	12.0	12.0	
	Tbivalent / TOL	°C	2 / 2	-10 / -10	-15 / -22	
	SCOP / ns	(W/W) / %	6.20 / 245	4.82 / 190	4.28 / 168	
	Annual Consumption	kWh	2801	5146	6911	
	Class		A++	A++	A++	
	Low temperature Application (W55)					
	Application	Climate	Warmer	Average	Colder	
	Pdesign	kW	10.0	13.0	10.0	
	Tbivalent / TOL	°C	2 / 2	-3 / -10	-15 / -22	
	SCOP / ns	(W/W) / %	4.30 / 169	3.33 / 130	3.10 / 121	
	Annual Consumption	kWh	3104	8076	7955	
	Class		A++	A++	A+	
	Noise Level	Condition (Ambient/Water)		A35W7	A7W35	A2W35
		dB(A)		Cooling: 54	Heating: 55	-
Power level dB			Cooling: 72	Heating: 72	-	
Air Flow	m³/min (ft³/min)		Cooling: 97.8 (3450) Heating: 90.0 (3180)			
Refrigerant Control Device			Expansion Valve			
Refrigerant Oil	cm³		FV50S (1200)			
Refrigerant (R410A)	kg (oz)		2.55 (90.0)			
F-GAS	GWP		2088			
	CO2eq (ton) (Precharged / Maximum)		5.324 / 7.412			
Dimension	Height	mm (inch)	1340 (52-3/4)			
	Width	mm (inch)	900 (35-7/16)			
	Depth	mm (inch)	320 (12-19/32)			

Item		Unit	Outdoor Unit		
Net Weight		kg (lbs)	107 (236)		
Pipe Diameter	Liquid	mm (inch)	9.52 (3/8)		
	Gas	mm (inch)	15.88 (5/8)		
Standard Length		m (ft)	5 (16.4)		
Pipe Length Range		m (ft)	3 (9.8) ~ 30 (98.4)		
I/D & O/D Height Different		m (ft)	20 (65.6)		
Additional Gas Amount		g/m (oz/ft)	50 (0.5)		
Refrigerant Chargeless		m (ft)	10 (32.8)		
Compressor	Type		Hermetic Motor		
	Motor Type		Brushless (4-poles)		
	Rated Output	kW	4.30		
Fan	Type		Propeller Fan		
	Material		PP		
	Motor Type		DC (8-poles)		
	Input Power	W	-		
	Output Power	W	60		
	Fan Speed	rpm	Cooling: 630 (Top), 670 (Bottom) Heating: 580 (Top), 620 (Bottom)		
Heat Exchanger	Fin Material		Aluminium (Pre Coat)		
	Fin Type		Corrugated Fin		
	Row x Stage x FPI		2 x 51 x 18		
	Size (W x H X L)	mm	903.7 x 1295.4 x 38.1		
Power Source (Phase, Voltage, Cycle)		∅	Three		
		V	400		
		Hz	50		
Input Power		Condition (Ambient/Water)	A35W7	A7W35	A2W35
		kW	Cooling: 4.76	Heating: 3.74	Heating: 3.96
Maximum Input Power for Heatpump System		kW	6.59		
Power Supply 1 : Phase (∅) / Max. Current (A) / Max. Input Power (W)			3∅ / 9.9 / 6.59k		
Power Supply 2 : Phase (∅) / Max. Current (A) / Max. Input Power (W)			3∅ / 13.0 / 9.00k		
Power Supply 3 : Phase (∅) / Max. Current (A) / Max. Input Power (W)			- / - / -		
Starting current		A	7.1		
Running Current		Condition (Ambient/Water)	A35W7	A7W35	A2W35
		A	Cooling: 7.1	Heating: 5.7	Heating: 6.0
Maximum Current for Heatpump System		A	9.9		
Power Factor Power factor means total figure of compressor and outdoor fan motor.		%	Cooling: 97	Heating: 95	Heating: 96
Power Cord	Number of core		-		
	Length	m (ft)	-		
Thermostat			Electronic Control		
Protection Device			Electronic Control		

Item		Unit	Indoor Unit		
Performance Test Condition			EN 14511		
Operation Range	Outdoor Ambient	°C (min. / max.)	Cooling: 16 / 43 Heating: -20 / 35		
	Water Outlet	°C (min. / max.)	Cooling: 5 / 20 Heating (Tank): - / 65* Heating (Circuit): 20 / 55		
Internal Pressure Differential		kPa	Cooling: 40.0 Heating: 69.0		
Noise Level		Condition (Ambient/Water)	A35W7	A7W35	A2W35
		dB(A)	Cooling: 33	Heating: 33	-
		Power level dB	Cooling: 46	Heating: 46	-
Dimension	Height	mm (inch)	717 (28-7/32)		
	Width	mm (inch)	598 (23-17/32)		
	Depth	mm (inch)	1800 (70-27/32)		
Net Weight		kg (lbs)	126 (278)		
Refrigerant Pipe Diameter	Liquid	mm (inch)	9.52 (3/8)		
	Gas	mm (inch)	15.88 (5/8)		
Water Pipe Diameter	Room	mm (inch)	31 (1-1/4)		
	Shower	mm (inch)	19 (3/4)		
Water Drain Hose Inner Diameter		mm (inch)	12.10 (17/38)		
Pump	Motor Type		DC Motor		
	Input Power	W	132		
Hot Water Coil	Type		Brazed Plate		
	No. of Plates		52		
	Size (H x W x L)	mm	93 x 119 x 376		
	Water Flow Rate	l/min (m³/h)	Cooling: 35.0 (2.1) Heating: 45.9 (2.8)		
Pressure Relief Valve Water Circuit		kPa	Open: 300, Close: 266 and below		
Flow Switch	Type		Electronic Sensor		
Protection Device		A	Residual Current Circuit Breaker (25)		
Expansion Vessel	Volume	l	10		
	MWP	bar	3		
Capacity of Integrated Electric Heater / OLP TEMP		kW / °C	9.00 / 80		
Tank Volume (Spec / Nett)		L	200 / 185		
Max. Tank Water Set Temperature		°C	65		
Tank Coil Surface		m²	1.8		
Maximum Working Pressure	Heat / Cool	bar	3.0		
	Tank Circuit	bar	8.0		
Operating Pressure	Tank Unit	bar	3.5		
	Expansion Relief Valve	bar	8.0		
Expansion Vessel Pre-Charge Pressure (DHW Circuit)		bar	3.5		
Pressure Reducing Valve Set Pressure (DHW Circuit)		bar	3.5		

Item		Unit	Indoor Unit
Pressure Vessel	Material		EN-1.4521
	Volume	L	185
	Design Pressure	bar	10
Heat Exchanger	Material		EN-1.4162 / EN-1.4521
	Diameter	mm	22
	Thickness	mm	0.8
	Surface Area	m ²	1.8
	Total Length	m	25

Note:

- Cooling capacities are based on outdoor air temperature of 35°C Dry Bulb with controlled indoor water inlet temperature of 12°C and water outlet temperature of 7°C.
- Heating capacities are based on outdoor air temperature of 7°C Dry Bulb (44.6°F Dry Bulb), 6°C Wet Bulb (42.8°F Wet Bulb) with controlled indoor water inlet temperature of 30°C and water outlet temperature of 35°C.
- Specifications are subjected to change without prior notice for further improvement.
- * Above 55°C, only possible with backup heater operation.

3. Features

- **Inverter Technology**
 - Energy saving
- **High Efficiency**
- **Environment Protection**
 - Non-ozone depletion substances refrigerant (R410A)
- **Long Installation Piping**
 - Long piping up to 30 meter with height difference 20 meter
 - Flexible 4-way piping for outdoor unit
- **Easy to use control panel**
 - Auto mode
 - Holiday mode
 - Dry concrete function
 - Weekly timer setting
- **A-class energy efficiency pump**
 - Water pump speed can be set by selection at control panel
- **Improved deice cycle**
- **Protection Feature**
 - Random auto restart after power failure for safety restart operation
 - Gas leakage protection
 - Prevent compressor reverse cycle
 - Inner protector to protect compressor
- **Serviceability Feature**
 - Breakdown Self Diagnosis function
 - System Status Check Buttons for servicing purpose
 - System Pumpdown Button for servicing purpose
 - Front maintenance design for outdoor unit

4. Location of Controls and Components

4.1 Indoor Unit

4.1.1 Remote Controller buttons and display

Buttons / Indicator	
①	Quick Menu button (For more details, refer to the separate Quick Menu Guide.)
②	Back button Returns to the previous screen
③	LCD Display
④	Main Menu button For function setup
⑤	ON/OFF button Starts/Stops operation
⑥	Operation indicator Illuminates during operation, blinks during alarm.

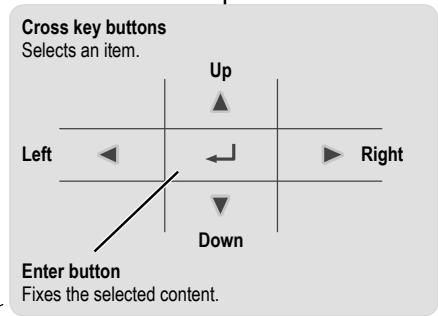
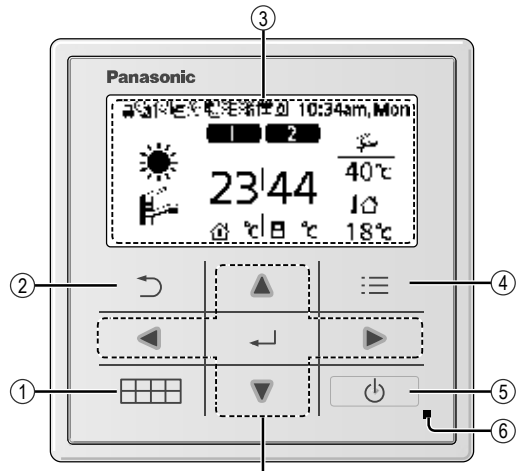

! Press centre

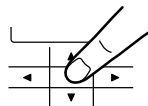

⊘ No glove

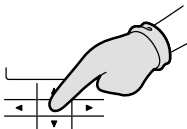

⊘ No pen

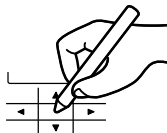

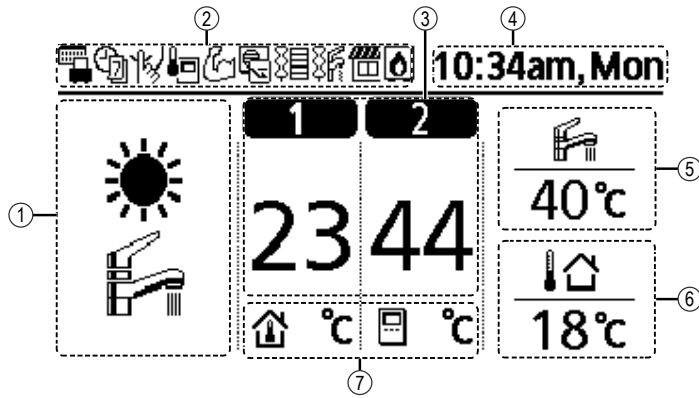

Display

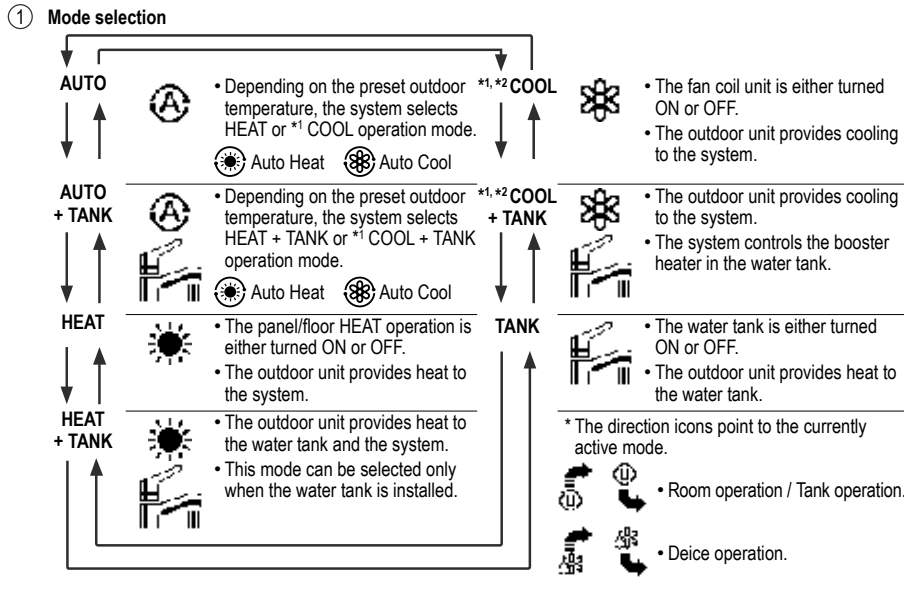

- ② **Operation icons**
The status of operation is displayed.
Icon will not display (under operation OFF screen) whenever operation is OFF except weekly timer.
- | | | |
|---|-------------------------------|--|
| Holiday operation status | Weekly Timer operation status | Quiet operation status |
| Zone:Room Thermostat
→Internal sensor status | Powerful operation status | Demand Control or SG ready or SHP status |
| Room Heater status | Tank Heater status | Solar status |
| Bivalent status (Boiler) | | |

*1 The system is locked to operate without COOL mode. It can be unlocked only by authorised installers or our authorised service partners.
*2 Only displayed when COOL mode is unlocked (This means when COOL mode is available).



- ③ **Temperature of each zone**
- ④ **Time and day**
- ⑤ **Water Tank temperature**
- ⑥ **Outdoor temperature**
- ⑦ **Sensor type/Set temperature type icons**
- | | | |
|--|------------------------------|-----------|
| Water Temperature
→Compensation curve | Water Temperature
→Direct | Pool only |
| Room Thermostat
→External | Room Thermostat
→Internal | |

4.1.2 Initialization

Before starting to install the various menu settings, please initiate the Remote Controller by selecting the language of operation and installing the date and time correctly. It is recommended that the installer conducts the following initialization of the Remote Controller.

Selecting the language





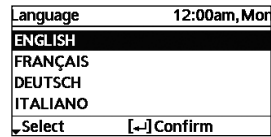

Press  and wait while the display is initializing.

- ① Scroll with  and  to select the language.
- ② Press  to confirm the selection.

Initialization 12:00am, Mon LCD blinking



Setting the clock

- ① Select with  or  how to display the time, either 24h or am/pm format (for example, 15:00 or 3 pm).
- ② Press  to confirm the selection.
- ③ Use  and  to select year, month, day, hour and minutes. (Press  to confirm the selection each time.)
- ④ Once the time is set, time and day will appear on the display even if the Remote Controller is turned OFF.

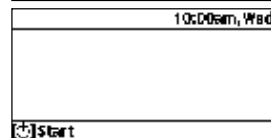
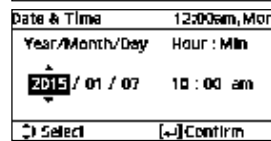
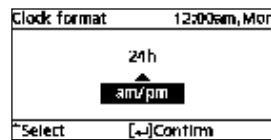

4.1.3 Quick Menu

After the initial settings have been completed, you can select a quick menu from the following options and edit the setting.

① Press  to display the quick menu.

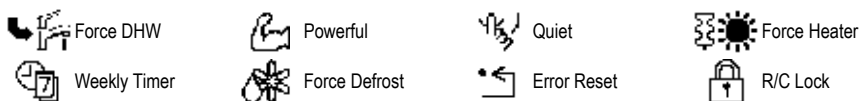
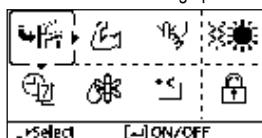

② Use     to select menu.

③ Press  to turn on/off the select menu.

4.1.4 Menus (For user)

Select menus and determine settings according to the system available in the household. All initial settings must be done by an authorised dealer or a specialist. It is recommended that all alterations of the initial settings are also done by an authorised dealer or a specialist.



- After initial installation, you may manually adjust the settings.
- The initial setting remains active until the user changes it.
- The Remote Controller can be used for multiple installations.
- Ensure the operation indicator is OFF before setting.
- The system may not work properly if set wrongly. Please consult an authorised dealer.

To display <Main Menu>: 



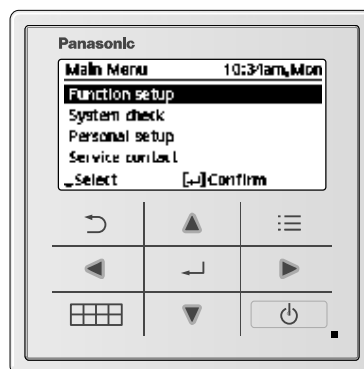

To select menu:    

To confirm the selected content: 

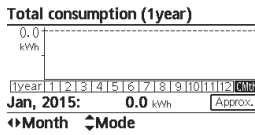

Menu	Default Setting	Setting Options / Display
1 Function setup		
1.1 > Weekly timer		
Once the weekly timer is set up, User can edit from Quick Menu. To set up to 6 patterns of operation on a weekly basis. • Disabled if Heat-Cool SW is pressed or if Force Heater is on.	Timer setup Select day of the week and set the patterns needed (Time / Operation ON/OFF / Mode)	Weekly timer 10:34am, Mon Sun Mon Tue Wed Thu Fri Sat 1. 8:00am ON  40°C 2. 12:00pm ON  24/28°C 40°C 3. 1:00pm ON  12/10°C ↔Day ↘Pattern [↔]Edit
	Timer copy Select day of the week	

Menu	Default Setting	Setting Options / Display												
1.2 > Holiday timer														
<p>To save energy, a holiday period may be set to either turn OFF the system or lower the temperature during the period.</p> <p>• Weekly timer setting may be temporarily disabled during Holiday timer setting but it will be restored once the Holiday timer is completed.</p>	OFF	<p>ON OFF</p>												
	> ON													
	<p>Holiday start and end. Date and time</p> <p>OFF or lowered temperature</p>	<p>Holiday: End 10:30am, Mon</p> <p>Year/Month/Day Hour: Min</p> <p>2015 / 01 / 07 10:00 am</p> <p>Select [-] Confirm</p>												
1.3 > Quiet timer														
<p>To operate quietly during the preset period. 6 patterns may be set. Level 0 means the mode is off.</p>	Time to start Quiet : Date and time	<p>Quiet 10:30am, Mon</p> <table border="1"> <thead> <tr> <th>Pattern</th> <th>Time</th> <th>Level</th> </tr> </thead> <tbody> <tr> <td>1</td> <td>0:00am</td> <td>0</td> </tr> <tr> <td>2</td> <td>5:00pm</td> <td>1</td> </tr> <tr> <td>3</td> <td>11:00pm</td> <td>3</td> </tr> </tbody> </table> <p>Select [-] Edit</p>	Pattern	Time	Level	1	0:00am	0	2	5:00pm	1	3	11:00pm	3
	Pattern	Time	Level											
1	0:00am	0												
2	5:00pm	1												
3	11:00pm	3												
Level of quietness: 0 ~ 3														
1.4 > Room heater														
To set the room heater ON or OFF.	OFF	<p>ON OFF</p>												
1.5 > Tank heater														
To set the tank heater ON or OFF.	OFF	<p>ON OFF</p>												
1.6 > Sterilization														
To set the auto sterilization ON or OFF.	ON	<p>ON OFF</p>												
<p>• Do not use the system during sterilization in order to prevent scalding with hot water, or overheating of shower.</p> <p>• Ask an authorised dealer to determine the level of sterilization function field settings according to the local laws and regulations.</p>														
1.7 > DHW mode (Domestic Hot Water)														
<p>To set the DHW mode to Standard or Smart.</p> <p>• Standard mode have faster DHW Tank heat up time. Meanwhile Smart mode take longer time to heat up DHW time with lower energy consumption.</p>	Standard	<p>Standard Smart</p>												

Menu	Default Setting	Setting Options / Display
2 System check		
2.1 > Energy monitor		
Present or historical chart of energy consumption, generation or COP. • COP= Coefficient of Performance. • For historical chart, the period is selected from 1 day/1 week/1year. • Energy consumption (kWh) of heating, *1 cooling, tank and total may be retrieved. • The total power consumption is an estimated value based on AC 230 V and may differ from value measured by precise equipment.	Present Select and retrieve	Total consumption (1year) 0.0 kWh  1year 1 2 3 4 5 6 7 8 9 10 11 12 kWh Jan, 2015: 0.0 kWh [Approx.] ◀Month ▶Mode
	Historical chart Select and retrieve	
2.2 > Water temperatures		
Shows all water temperatures in each area.	Actual water temperature of 8 items: Inlet / Outlet / Zone 1 / Zone 2 / Tank / Buffer tank / Solar / Pool Select and retrieve	Water temperatures 10:34am, Mon 1. Inlet : 0 °C 2. Outlet : 0 °C 3. Zone 1 : 0 °C 4. Zone 2 : 0 °C ▼Page
2.3 > Error history		
• Refer to Troubleshooting for error codes. • The most recent error code is displayed at the top.	Select and retrieve	Error history 10:34am, Mon 1. -- 2. -- 3. -- 4. -- [Clear] Clear history
2.4 > Compressor		
Shows the compressor performance.	Select and retrieve	Compressor 10:34am, Mon 1. Current frequency : 0 Hz 2. (OFF-ON) counter : 0 3. Total ON time : 0 h [Back]
2.5 > Heater		
Total hours of ON time for Room heater/Tank heater.	Select and retrieve	Heater 10:34am, Mon Total ON time  : 0h  : 0h [Back]
3 Personal setup		
3.1 > Touch sound		
Turns the operation sound ON/OFF.	ON	
3.2 > LCD contrast		
Sets the screen contrast.	3	LCD contrast 10:34am, Mon Low High  [Select] [Confirm]

*1 The system is locked to operate without COOL mode. It can be unlocked only by authorised installers or our authorised service partners.
 *2 Only displayed when COOL mode is unlocked (This means when COOL mode is available).

Menu	Default Setting	Setting Options / Display
3.3 > Backlight		
Sets the duration of screen backlight.	1 min	Backlight 10:34am, Mon OFF 5 mins 15 secs 10 mins 1 min ▲ Select [-] Confirm
3.4 > Backlight intensity		
Sets screen backlight brightness.	4	Backlight intensity 10:34am, Mon Dark Bright ◀ Select [-] Confirm
3.5 > Clock format		
Sets the type of clock display.	24h	Clock format 10:34am, Mon 24h am/pm ▲ Select [-] Confirm
3.6 > Date & Time		
Sets the present date and time.	Year / Month / Day / Hour / Min	Date & Time 10:34am, Mon Year/Month/Day Hour : Min 2015 / 01 / 07 10 : 00 am ▲ Select [-] Confirm
3.7 > Language		
Sets the display language for the top screen. • For Dutch, Greek, Finnish and Turkish, please refer to the English version.	ENGLISH / FRANÇAIS / DEUTSCH / ITALIANO / ESPAÑOL / DANISH / SWEDISH / NORWEGIAN / POLISH / CZECH	Language 10:34am, Mon ENGLISH FRANÇAIS DEUTSCH ITALIANO ▼ Select [-] Confirm
3.8 > Unlock password		
4 digit password for all the settings.	0000	Unlock password 10:34am, Mon 0000 ▼ Select [-] Confirm
4 Service contact		
4.1 > Contact 1 / Contact 2		
Preset contact number for installer.	Select and retrieve	Service setup 10:34am, Mon Contact 1 Name : Bayan Adams ☎ : 08812345678 ▼ Select

4.1.5 Menus (For installer)

Menu	Default Setting	Setting Options / Display
5 Installer setup > System setup		
5.1 > Optional PCB connectivity		
To connect to the external PCB required for servicing.	No	Yes No
<ul style="list-style-type: none"> If the external PCB is connected (optional), the system will have following additional functions: <ol style="list-style-type: none"> Buffer tank connection and control over its function and temperature. Control over 2 zones (including the swimming pool and the function to heat water in it). Solar function (the solar thermal panels connected to either the DHW (Domestic Hot Water) Tank or the Buffer Tank). External compressor switch. External error signal. SG ready control. Demand control. Heat-Cool SW 		
5.2 > Zone & Sensor		
To select the sensors and to select either 1 zone or 2 zone system.	Zone <ul style="list-style-type: none"> After selecting 1 or 2 zone system, proceed to the selection of room or swimming pool. If the swimming pool is selected, the temperature must be selected for ΔT temperature between 2 °C ~ 10 °C. Sensor <ul style="list-style-type: none"> * For room thermostat, there is a further selection of external or internal. 	Zone & Sensor 10:34am, Mon Zone: 1 Zone system 2 Zones system Select Confirm Zone & Sensor 10:34am, Mon Sensor: Water temperature Room thermostat Room thermostat Select Confirm
5.3 > Heater capacity		
To reduce the heater power if unnecessary.* 3 kW / 6 kW / 9 kW * Options of kW vary depending on the model.	9 kW	Heater capacity 10:34am, Mon 3 kW 6 kW 9 kW Select Confirm
5.4 > Anti freezing		
To activate or deactivate the water freeze prevention when the system is OFF	Yes	Yes No
5.5 > Buffer tank connection		
To connect tank to the system and if selected YES, to set ΔT temperature.	No	Yes No
<ul style="list-style-type: none"> The optional PCB connectivity must be selected YES to enable the function. If the optional PCB connectivity is not selected, the function will not appear on the display. 	> Yes 5 °C Set ΔT for Buffer Tank	Buffer Tank 10:34am, Mon ΔT for Buffer Tank Range: (0°C~10°C) Steps: $\pm 1^\circ\text{C}$ 5 °C Select Confirm

Menu	Default Setting	Setting Options / Display	
5.6 > Base pan heater			
<p>To select whether or not optional base pan heater is connected.</p> <p>* Type A - The base pan heater activates only during deice operation.</p> <p>* Type B - The base pan heater activates when outdoor ambient temperature is 5 °C or lower.</p>	No	<p>Yes ▲ No</p>	
	> Yes		
A	Set base pan heater type*.	<p>Base pan heater type: 10:34am, Mon</p> <p>A ▼ B</p> <p>↵ Select [-] Confirm</p>	
5.7 > Alternative outdoor sensor			
To select an alternative outdoor sensor.	No	<p>Yes ▲ No</p>	
5.8 > Bivalent connection			
<p>To select a bivalent connection to allow an additional heat source such as a boiler to heat-up the buffer tank and domestic hot water tank when heatpump capacity is insufficient at low outdoor temperature. The bivalent feature can be set-up either in alternative mode (heatpump and boiler operate alternately), or in parallel mode (both heatpump and boiler operate simultaneously), or in advance parallel mode (heatpump operates and boiler turns on for buffer-tank and/or domestic hot water depending on the control pattern setting options).</p>	No	<p>Yes ▲ No</p>	
	> Yes		
	-5 °C	Set outdoor temperature for turn ON Bivalent connection.	<p>Bivalent connection: 10:34am, Mon</p> <p>Turn ON: Outdoor Temp</p> <p>Range: (-15°C~35°C)</p> <p>Steps: 1°C ▲ -5 °C ▼</p> <p>↵ Select [-] Confirm</p>
	Yes > After selecting the outdoor temperature		
	Control pattern		Bivalent connection: 10:34am, Mon
Alternative / Parallel / Advanced parallel		Control pattern	
<ul style="list-style-type: none"> Select advanced parallel for bivalent use of the tanks. 		<p>Alternative</p> <p>Parallel</p> <p>Advanced parallel</p> <p>↵ Select [-] Confirm</p>	
Control pattern > Advanced parallel			
Heat	Selection of the tank	Bivalent connection: 10:34am, Mon	
<ul style="list-style-type: none"> "Heat" implies Buffer Tank and "DHW" implies Domestic Hot Water Tank. 		<p>Advanced parallel</p> <p>Heat</p> <p>DHW</p> <p>↵ Select [-] Confirm</p>	

Menu	Default Setting	Setting Options / Display
Control pattern > Advanced parallel > Heat > Yes		
	• Buffer Tank is activated only after selecting "Yes".	Bivalent connection 10:34am, Mon Advanced parallel: Heat <input checked="" type="checkbox"/> Yes <input type="checkbox"/> No ↵ Select [↵] Confirm
-8 °C	Set the temperature threshold to start the bivalent heat source.	Bivalent connection 10:34am, Mon Heat start: Target temp. Range: (-10°C-0°C) Steps: ±1°C <input type="text" value="-8"/> °C ↵ Select [↵] Confirm
0:30	Delay timer to start the bivalent heat source (in hour and minutes).	Bivalent connection 10:34am, Mon Heat start: Delay time Range: (0:00-1:30) Steps: ±0:05 <input type="text" value="0:30"/> ↵ Select [↵] Confirm
-2 °C	Set the temperature threshold to stop the bivalent heat source.	Bivalent connection 10:34am, Mon Heat stop: Target temp. Range: (-10°C-0°C) Steps: ±1°C <input type="text" value="-2"/> °C ↵ Select [↵] Confirm
0:30	Delay timer to stop the bivalent heat source (in hour and minutes).	Bivalent connection 10:34am, Mon Heat stop: Delay time Range: (0:00-1:30) Steps: ±0:05 <input type="text" value="0:30"/> ↵ Select [↵] Confirm
Control pattern > Advanced parallel > DHW > Yes		
	• DHW Tank is activated only after selecting "Yes".	Bivalent connection 10:34am, Mon Advanced parallel: DHW <input checked="" type="checkbox"/> Yes <input type="checkbox"/> No ↵ Select [↵] Confirm
0:30	Delay timer to start the bivalent heat source (in hour and minutes).	Bivalent connection 10:34am, Mon DHW: Delay time Range: (0:30-1:30) Steps: ±0:05 <input type="text" value="0:30"/> ↵ Select [↵] Confirm
5.9	> External SW	
	No	<input type="checkbox"/> Yes <input checked="" type="checkbox"/> No

Menu	Default Setting	Setting Options / Display	
5.10 > Solar connection			
<ul style="list-style-type: none"> The optional PCB connectivity must be selected YES to enable the function. If the optional PCB connectivity is not selected, the function will not appear on the display. 	No	<div style="text-align: right;">Yes ▲ No</div>	
	> Yes		
	Buffer tank	Selection of the tank	Solar connection 10:34am, Mon ΔT Turn ON Range: (6°C-15°C) Steps: ±1°C <div style="text-align: center;">Buffer Tank</div> <div style="text-align: center;">▼</div> <div style="text-align: center;">CHW tank</div> <div style="text-align: right;">Select [-] Confirm</div>
	> Yes > After selecting the tank		
	10 °C	Set ΔT ON temperature	Solar connection 10:34am, Mon ΔT Turn ON Range: (6°C-15°C) Steps: ±1°C <div style="text-align: center;">10 °C</div> <div style="text-align: right;">Select [-] Confirm</div>
	> Yes > After selecting the tank > ΔT ON temperature		
	5 °C	Set ΔT OFF temperature	Solar connection 10:34am, Mon ΔT Turn OFF Range: (2°C-9°C) Steps: ±1°C <div style="text-align: center;">5 °C</div> <div style="text-align: right;">Select [-] Confirm</div>
> Yes > After selecting the tank > ΔT ON temperature > ΔT OFF temperature			
5 °C	Set Antifreeze temperature	Solar connection 10:34am, Mon Anti freeze Range: (-20°C-10°C) Steps: ±1°C <div style="text-align: center;">5 °C</div> <div style="text-align: right;">Select [-] Confirm</div>	
> Yes > After selecting the tank > ΔT ON temperature > ΔT OFF temperature > After setting the antifreeze temperature			
80 °C	Set Hi limit	Solar connection 10:34am, Mon Hi limit Range: (71°C-101°C) Steps: ±5°C <div style="text-align: center;">80 °C</div> <div style="text-align: right;">Select [-] Confirm</div>	
5.11 > External error signal			
	No	<div style="text-align: right;">Yes ▲ No</div>	
5.12 > Demand control			
	No	<div style="text-align: right;">Yes ▲ No</div>	

Menu	Default Setting	Setting Options / Display
5.13 > SG ready		
	No	Yes No
	> Yes	
	120 %	SG ready 10:34am, Mon Capacity [1-10]: DHW Range: (50%-150%) Steps: ±5% 120 % Select [-] Confirm
5.14 > External compressor SW		
	No	Yes No
5.15 > Circulation liquid		
To select whether to circulate water or glycol in the system.	Water	Circulation liquid 10:34am, Mon Water Glycol Select [-] Confirm
5.16 > Heat-Cool SW		
	No	Yes No
5.17 > Force heater		
To select use Auto turn ON force heater mode or Manual force heater mode.	Manual	Force heater 10:34am, Mon Auto Manual Select [-] Confirm
6 Installer setup > Operation setup		
To access to the four major functions or modes.	4 main modes Heat / *1, *2 Cool / Auto / Tank	Operation setup 12:00am, Mon Heat Cool Auto Tank Select [-] Confirm
6.1 > Heat		
To set various water & ambient temperatures for heating.	Water temp. for heating ON / Outdoor temp. for heating OFF / ΔT for heating ON / Outdoor temp. for heater ON	Operation setup 10:34am, Mon Heat Water temp. for heating ON Outdoor temp. for heating OFF ΔT for heating ON Select [-] Confirm
	> Water temp. for heating ON	
	Compensation curve	Operation setup 10:34am, Mon Heat ON: Water temp. Compensation curve Direct Select [-] Confirm



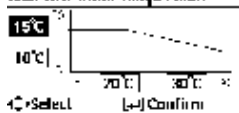

*1 The system is locked to operate without COOL mode. It can be unlocked only by authorised installers or our authorised service partners.
*2 Only displayed when COOL mode is unlocked (This means when COOL mode is available).

Menu	Default Setting	Setting Options / Display
> Water temp. for heating ON > Compensation curve		
X axis: -5 °C, 15 °C Y axis: 55 °C, 35 °C	Input the 4 temperature points (2 on horizontal X axis, 2 on vertical Y axis).	<p>Heat ON: Water temp. Zone1 55 °C 35 °C -5 °C 15 °C Select Confirm</p>
<ul style="list-style-type: none"> • Temperature range: X axis: -15 °C ~ 15 °C, Y axis: See below • Temperature range for the Y axis input: <ol style="list-style-type: none"> 1. WH-UD model: 20 °C ~ 55 °C 2. WH-UH model & Back up heater is enabled: 25 °C ~ 65 °C 3. WH-UH model & Back up heater is disabled: 35 °C ~ 65 °C 4. WH-UX model: 20 °C ~ 60 °C • If 2 zone system is selected, the 4 temperature points must also be input for Zone 2. • "Zone 1" and "Zone 2" will not appear on the display if only 1 zone system. 		
> Water temp. for heating ON > Direct		
35 °C	Temperature for heating ON	<p>Operation setup 10:34am, Mon Heat ON: Water temp.: Zone2 Range: (20°C-55°C) Steps: ±1°C 35 °C Select Confirm</p>
<ul style="list-style-type: none"> • Min. ~ Max. range is conditional as follows: <ol style="list-style-type: none"> 1. WH-UD model: 20 °C ~ 55 °C 2. WH-UH model & Back up heater is enabled: 25 °C ~ 65 °C 3. WH-UH model & Back up heater is disabled: 35 °C ~ 65 °C 4. WH-UX model: 20 °C ~ 60 °C 		
> Outdoor temp. for heating OFF		
24 °C	Temperature for heating OFF	<p>Operation setup 10:34am, Mon Heat OFF: Outdoor temp. Range: (5°C-35°C) Steps: ±1°C 24 °C Select Confirm</p>
> ΔT for heating ON		
5 °C	Set ΔT for heating ON.	<p>Operation setup 10:34am, Mon Heat ON: ΔT Range: (1°C-15°C) Steps: ±1°C 5 °C Select Confirm</p>
> Outdoor temp. for heater ON		
0 °C	Temperature for heater ON	<p>Operation setup 10:34am, Mon Heater ON: Outdoor temp. Range: (-15°C-20°C) Steps: ±1°C 0 °C Select Confirm</p>

Menu	Default Setting	Setting Options / Display
6.2 > *1, *2 Cool		
To set various water & ambient temperatures for cooling.	Water temperatures for cooling ON and ΔT for cooling ON.	Operation setup 10:34am, Mon Cool Water temp. for cooling ON ΔT for cooling ON [Left] Select [Right] Confirm
	> Water temp. for cooling ON	
	Compensation curve	Operation setup 10:34am, Mon Cool ON: Water temp. Compensation curve Direct [Left] Select [Right] Confirm
	> Water temp. for cooling ON > Compensation curve	
	X axis: 20 °C, 30 °C Y axis: 15 °C, 10 °C	Input the 4 temperature points (2 on horizontal X axis, 2 on vertical Y axis)  [Left] Select [Right] Confirm
	<ul style="list-style-type: none"> If 2 zone system is selected, the 4 temperature points must also be input for Zone 2. "Zone 1" and "Zone 2" will not appear on the display if only 1 zone system. 	
	> Water temp. for cooling ON > Direct	
	10 °C	Operation setup 10:34am, Mon Cool ON: Water temp.: Zone2 Range: (5°C-20°C) Steps: $\pm 1^\circ\text{C}$ [Left] Select [Right] Confirm
	> ΔT for cooling ON	
	5 °C	Operation setup 10:34am, Mon Cool ON: ΔT Range: (1°C-15°C) Steps: $\pm 1^\circ\text{C}$ [Left] Select [Right] Confirm

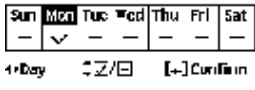
*1 The system is locked to operate without COOL mode. It can be unlocked only by authorised installers or our authorised service partners.
 *2 Only displayed when COOL mode is unlocked (This means when COOL mode is available).

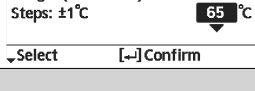
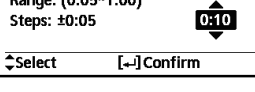
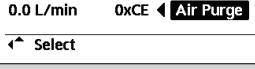
Menu	Default Setting	Setting Options / Display
6.3 > Auto		
Automatic switch from Heat to Cool or Cool to Heat.	Outdoor temperatures for switching from Heat to Cool or Cool to Heat. Outdoor temp. for (Heat to Cool) / Outdoor temp. for (Cool to Heat)	Operation setup 14:34am, Mon Auto Outdoor temp. for (Heat to Cool) Outdoor temp. for (Cool to Heat) Select [-] Confirm
	> Outdoor temp. for (Heat to Cool)	
	15 °C Set outdoor temperature for switching from Heat to Cool.	Operation setup 10:34am, Mon Auto: Outdoor temp.(Heat to Cool) Range: (11°C-25°C) Steps: ±1°C 15 °C Select [-] Confirm
	> Outdoor temp. for (Cool to Heat)	
	10 °C Set outdoor temperature for switching from Cool to Heat.	Operation setup 10:34am, Mon Auto: Outdoor temp.(Cool to Heat) Range: (5°C-14°C) Steps: ±1°C 10 °C Select [-] Confirm
6.4 > Tank		
Setting functions for the tank.	Floor operation time (max) / Tank heat up time (max) / Tank re-heat temp. / Sterilization	Operation setup 14:34am, Mon Tank Floor operation time (max) Tank heat up time (max) Tank re-heat temp. Select [-] Confirm
	• The display will show 3 functions at a time.	
	> Floor operation time (max)	
	8:00 Maximum time for floor operation (in hours and minutes)	Operation setup 14:34am, Mon Tank: Floor op. time (max) Range: (0:30-10:00) Steps: 30:30 8:00 Select [-] Confirm
	> Tank heat up time (max)	
	1:00 Maximum time for heating the tank (in hours and minutes)	Operation setup 14:34am, Mon Tank: Heat up time (max) Range: (0:05-4:00) Steps: +0:05 1:00 Select [-] Confirm
	> Tank re-heat temp.	
	-8 °C Set temperature to perform reboil of tank water.	Operation setup 14:34am, Mon Tank: Re-heat temp. Range: (-12°C--2°C) Steps: +1°C -8 °C Select [-] Confirm

Menu	Default Setting	Setting Options / Display
> Sterilization		
Monday	Sterilization may be set for 1 or more days of the week. Sun / Mon / Tue / Wed / Thu / Fri / Sat	Operation setup 10:34am, Mon Sterilization: Day 
> Sterilization: Time		
12:00	Time of the selected day(s) of the week to sterilize the tank 0:00 ~ 23:59	Operation setup 10:34am, Mon Sterilization: Time 
> Sterilization: Boiling temp.		
65 °C	Set boiling temperatures for sterilize the tank.	Operation setup 10:34am, Mon Sterilization: Boiling temp. Range: (55°C~65°C) Steps: ±1°C 
> Sterilization: Ope. time (max)		
0:10	Set sterilizing time (in hours and minutes)	Operation setup 10:34am, Mon Sterilization: Ope. time (max) Range: (0:05~1:00) Steps: ±0:05 
7 Installer setup > Service setup		
7.1 > Pump maximum speed		
To set the maximum speed of the pump.	Setting the flow rate, max. duty and operation ON/OFF of the pump. Flow rate: XX.X L/min Max. Duty: 0x40 ~ 0xFE, Pump: ON/OFF/Air Purge	Service setup 10:34am, Mon Flow rate Max. Duty Operation 0.0 L/min 0xCE ◀ Air Purge 
7.2 > Pump down		
To set the pump down operation.	Pump down operation ON	

Menu	Default Setting	Setting Options / Display	
7.3 > Dry concrete			
<p>To dry the concrete (floor, walls, etc.) during construction.</p> <p>Do not use this menu for any other purposes and in period other than during construction</p>	Edit to set the temperature of dry concrete. ON / Edit	Service setup 10:34am, Mon Dry concrete ON Edit Select [-] Confirm	
	> Edit		
	Stages: 1 Temperature: 25 °C	Heating temperature for drying the concrete. Select the desired stages: 1 ~ 10, range: 1 ~ 99	Service setup 10:34am, Mon Dry concrete: 1/10 Range: (25°C-55°C) Steps: ±1°C 25 °C Select [-] Confirm
	> ON		
Confirm the setting temperatures of dry concrete for each stage.		Service setup 10:34am, Mon Dry concrete: Status Stage : 1/10 Water set temp. : 25°C Actual water temp. :25°C/25°C OFF	
7.4 > Service contact			
<p>To set up to 2 contact names and numbers for the User.</p>	Service engineer's name and contact number. Contact 1 / Contact 2	Service setup 10:34am, Mon Service contact: Contact 1 Contact 2 Select [-] Confirm	
	> Contact 1 / Contact 2		
	Contact name or number. Name / phone icon	Service contact 10:34am, Mon Contact 1 Name : Bayan Aulins : 08812945878 Select [-] Edit	
	Input name and number Contact name: alphabet a ~ z. Contact number: 1 ~ 9	Contact-1 ABC/abc 0 9/0 Other ABCDEFGHI JKLMNOPQR Space STUVWXYZ abcdefghl BS jklmnopqr stuvwxyz Conf Select [-] Enter Number: 1 2 3 () 4 5 6) 7 8 9 BS * 0 # _ Conf Select [-] Enter	

4.1.6 Main Components

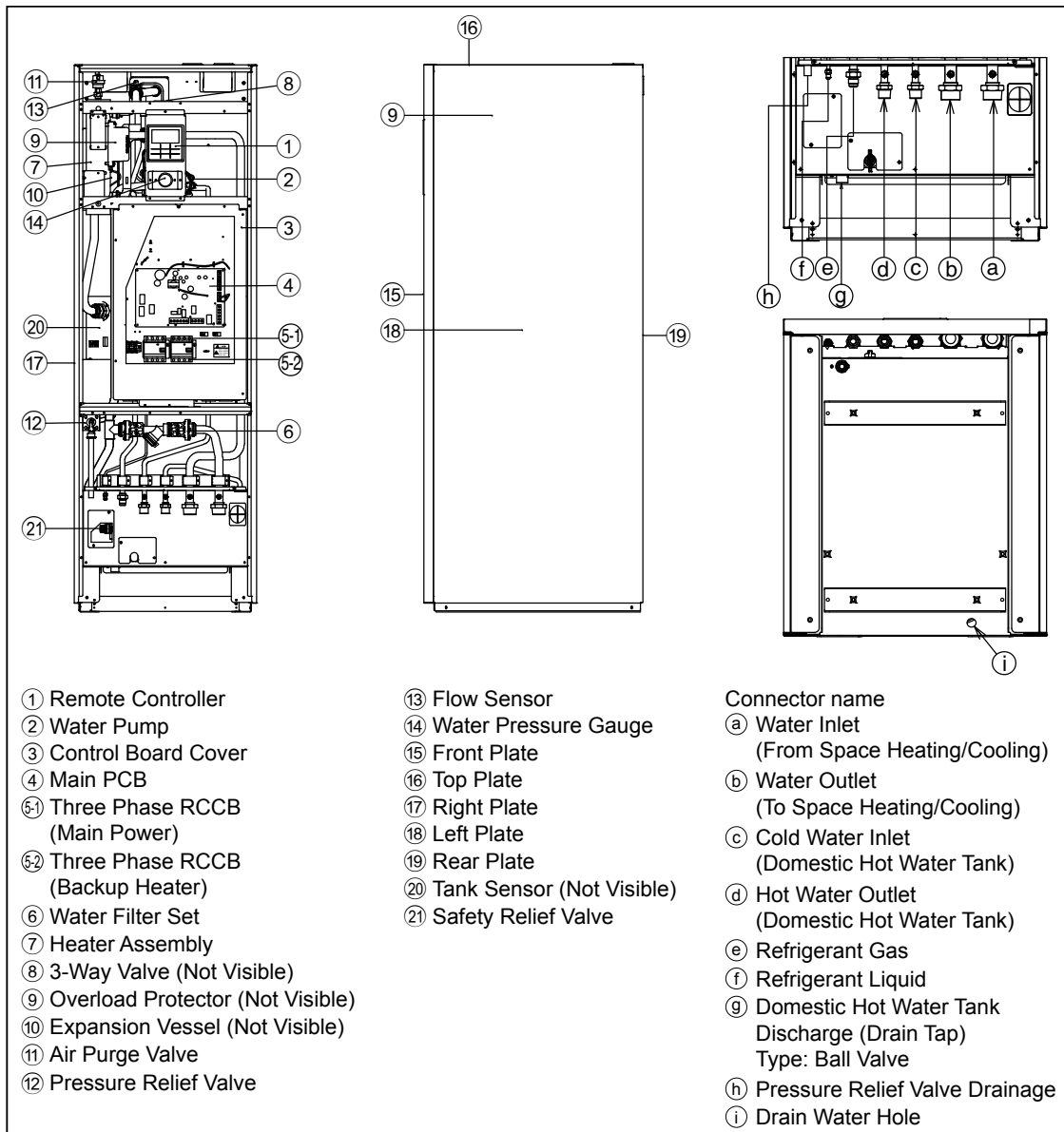

4.2 Outdoor Unit

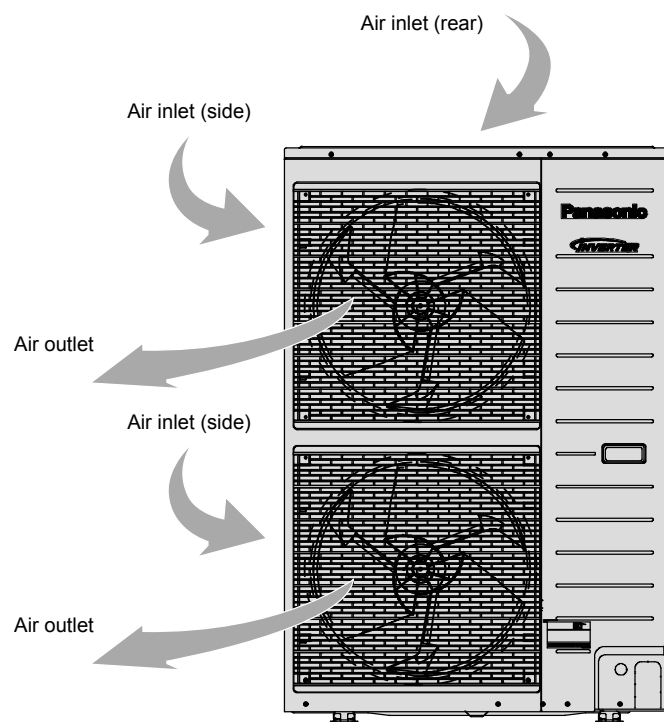

5. Dimensions

5.1 Indoor Unit

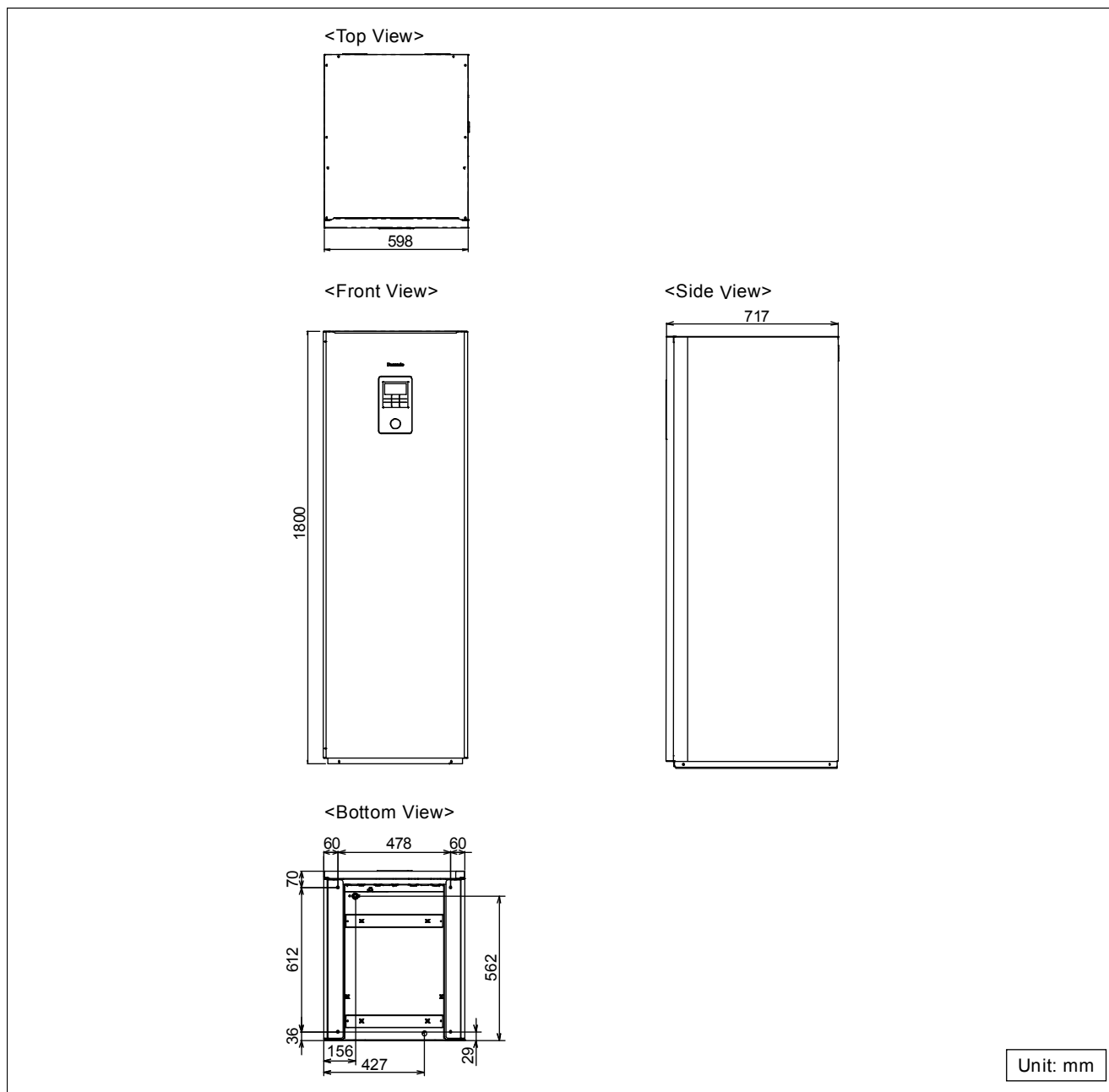

5.2 Outdoor Unit

5.2.1 WH-UD09HE8 WH-UD12HE8 WH-UD16HE8 WH-UX09HE8 WH-UX12HE8 WH-UX16HE8

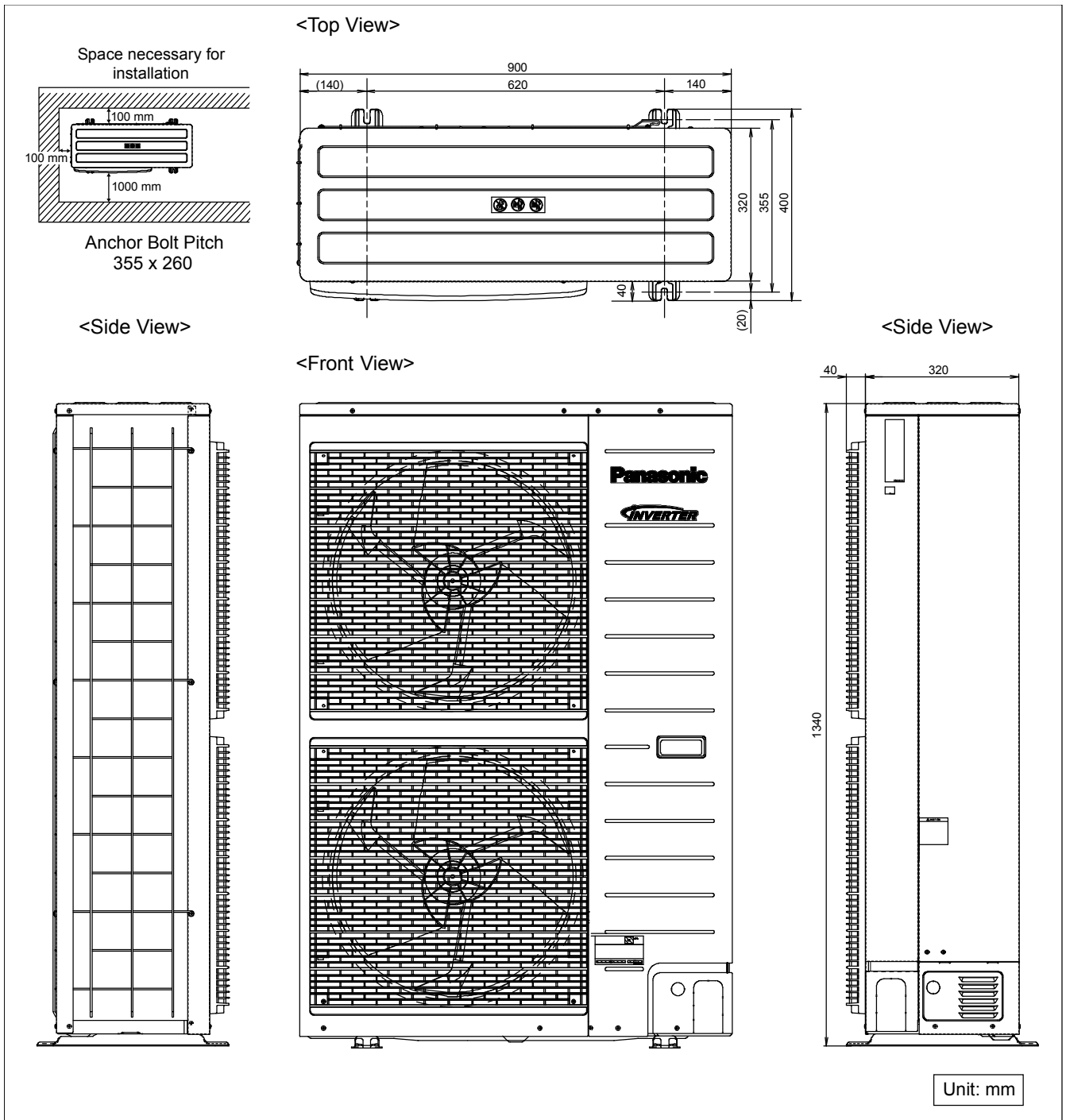

5.2.2 WH-UQ09HE8 WH-UQ12HE8 WH-UQ16HE8

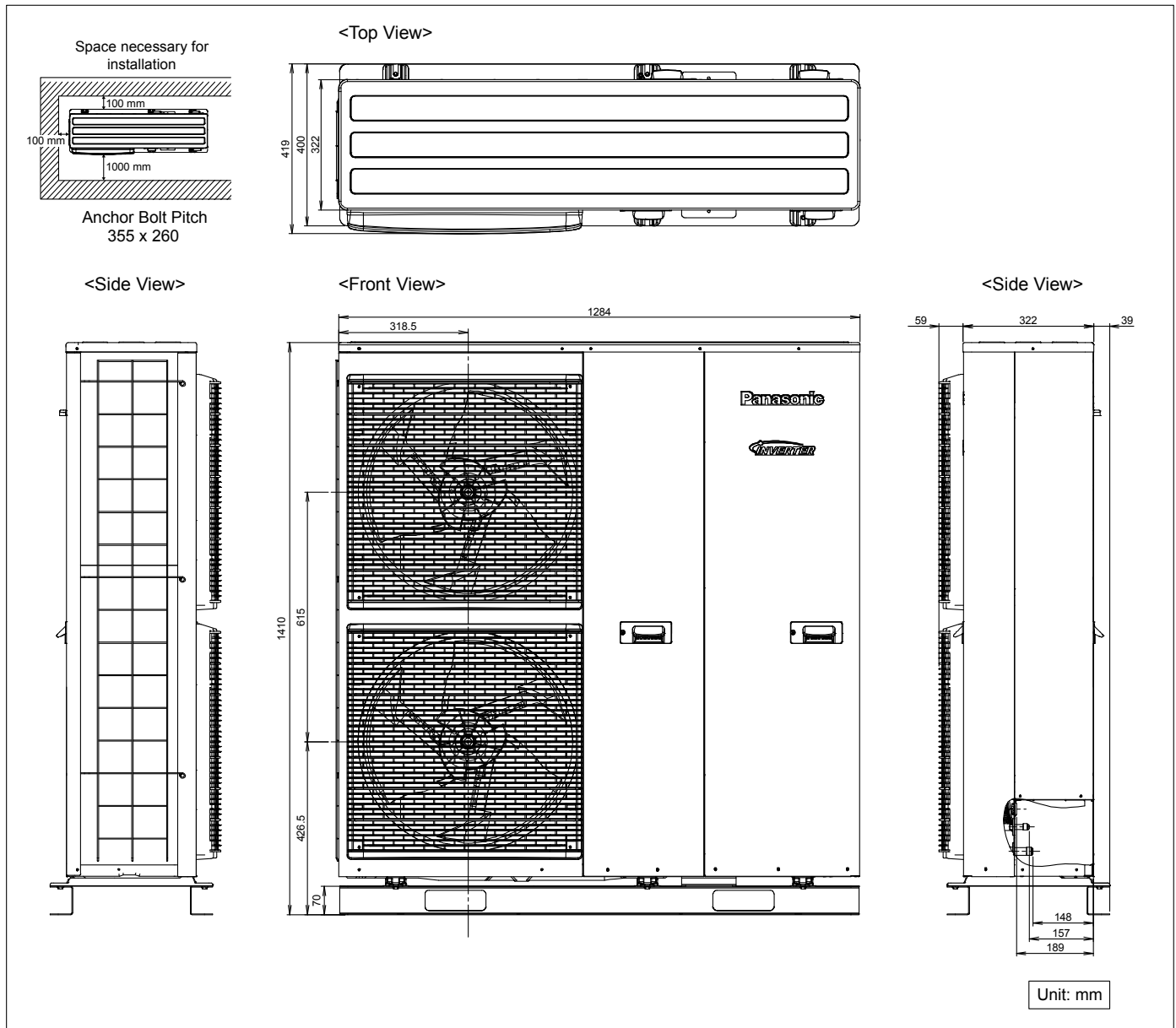

6. Refrigeration and Water Cycle Diagram

6.1 WH-ADC0916H9E8 WH-UX09/12/16HE8 WH-ADC0916H9E8 WH-UQ09/12/16HE8

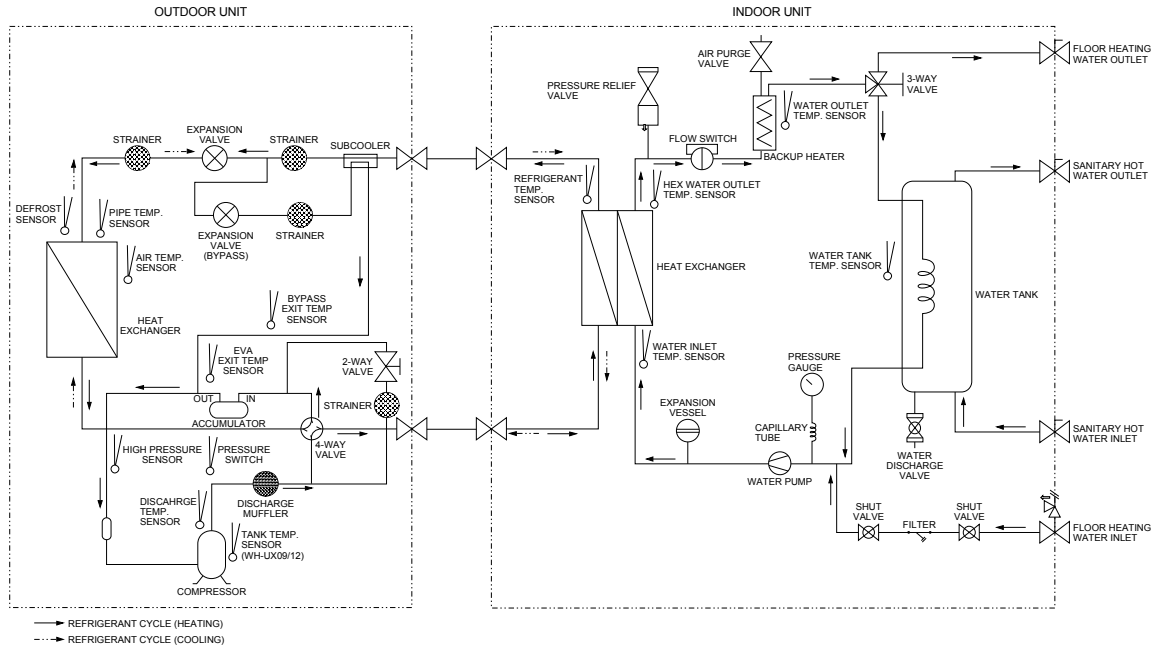

Model		Piping size (Torque)	
Tank Unit	Outdoor Unit	Gas	Liquid
ADC0916H9E8	WH-UX09HE8 / WH-UX12HE8 / WH-UX16HE8 / WH-UQ09HE8 / WH-UQ12HE8 / WH-UQ16HE8	Ø15.88 mm (5/8") [65 N•m]	Ø9.52 mm (3/8") [42 N•m]

6.2 WH-ADC0916H9E8 WH-UD09/12/16HE8

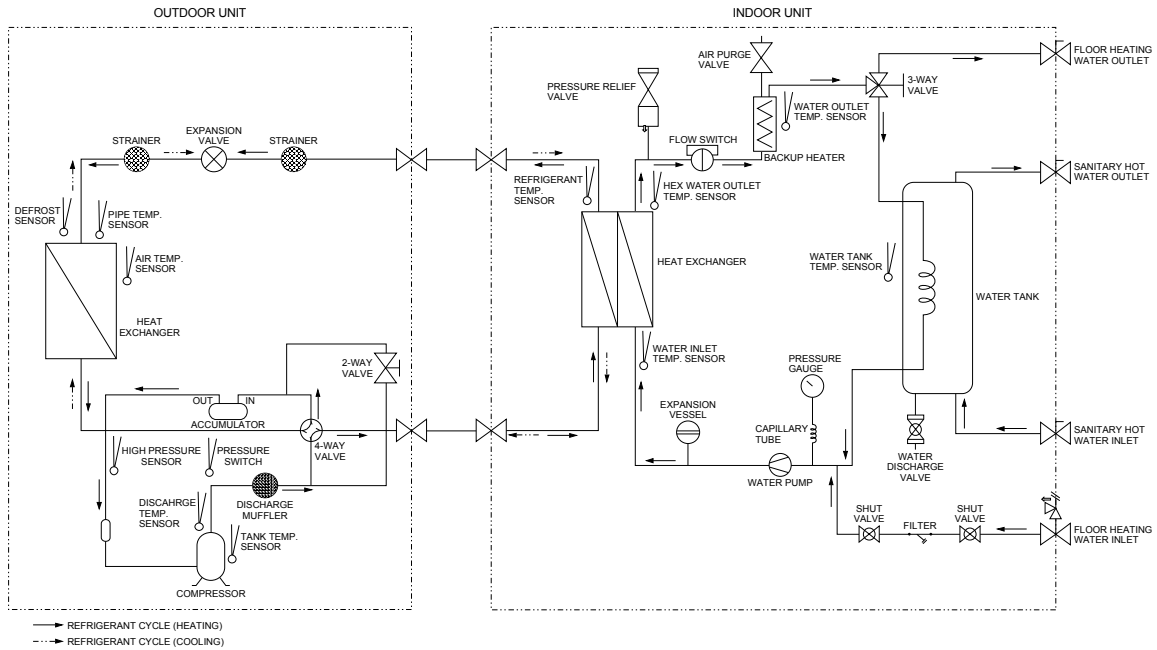

Model		Piping size (Torque)	
Tank Unit	Outdoor Unit	Gas	Liquid
ADC0916H9E8	WH-UD09HE8 / WH-UD12HE8 / WH-UD16HE8	Ø15.88 mm (5/8") [65 N•m]	Ø9.52 mm (3/8") [42 N•m]

7. Block Diagram

7.1 WH-ADC0916H9E8 WH-UQ09HE8 WH-ADC0916H9E8 WH-UQ12HE8 WH-ADC0916H9E8 WH-UX09HE8 WH-ADC0916H9E8 WH-UX12HE8

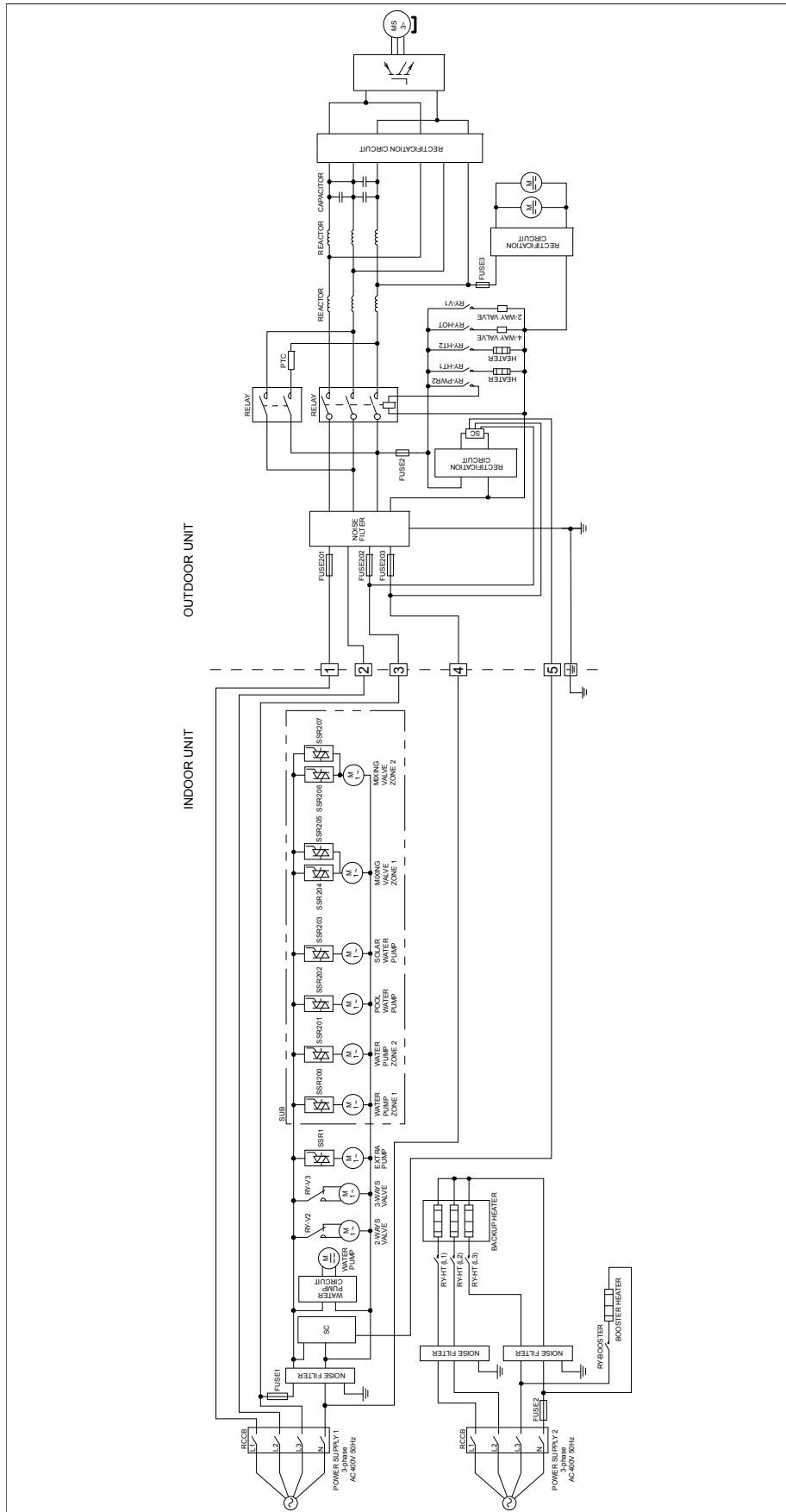

7.2 WH-ADC0916H9E8 WH-UQ16HE8 WH-ADC0916H9E8 WH-UX16HE8

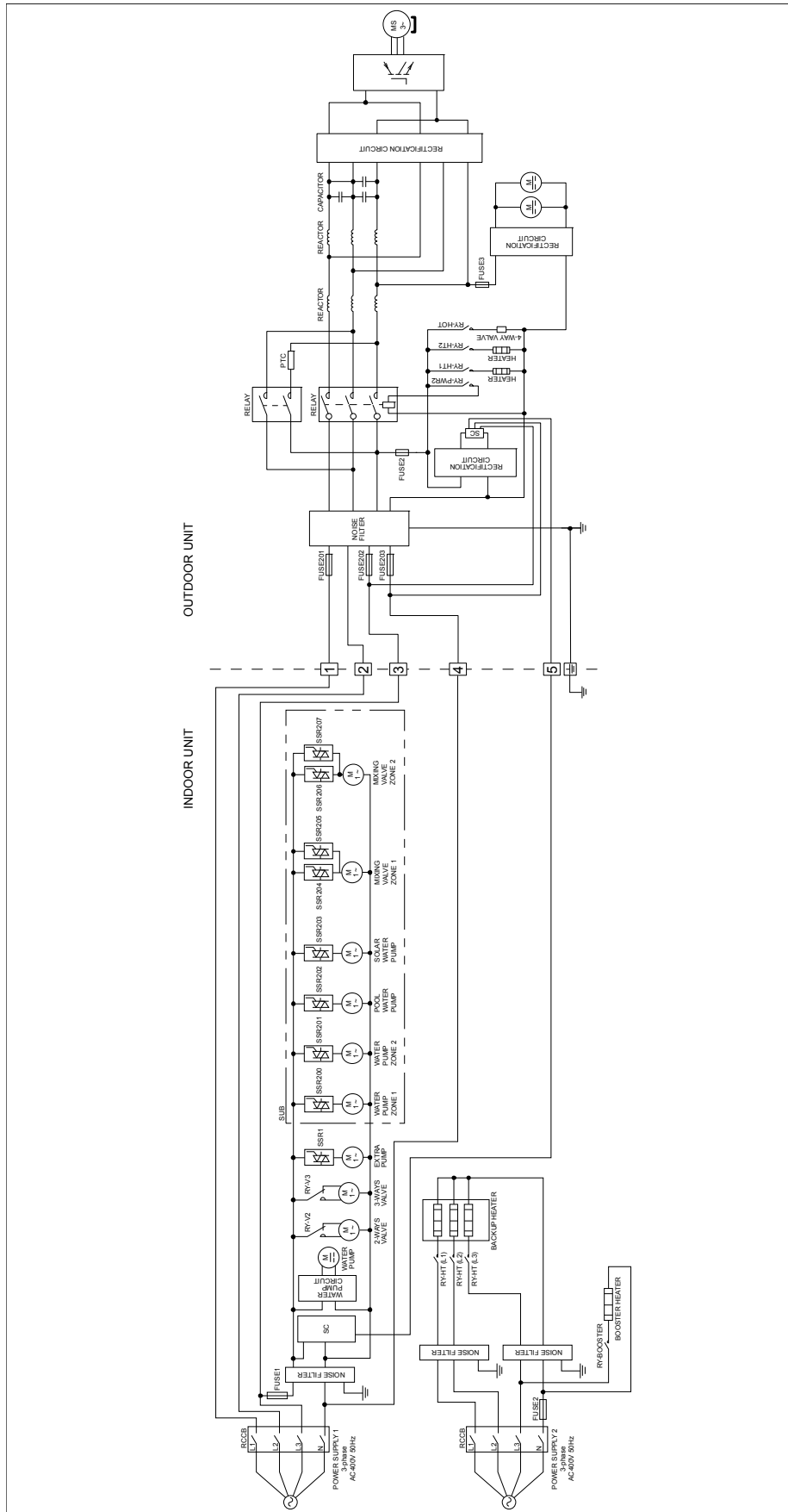

**7.3 WH-ADC0916H9E8 WH-UD09HE8 WH-ADC0916H9E8 WH-UD12HE8
WH-ADC0916H9E8 WH-UD16HE8**

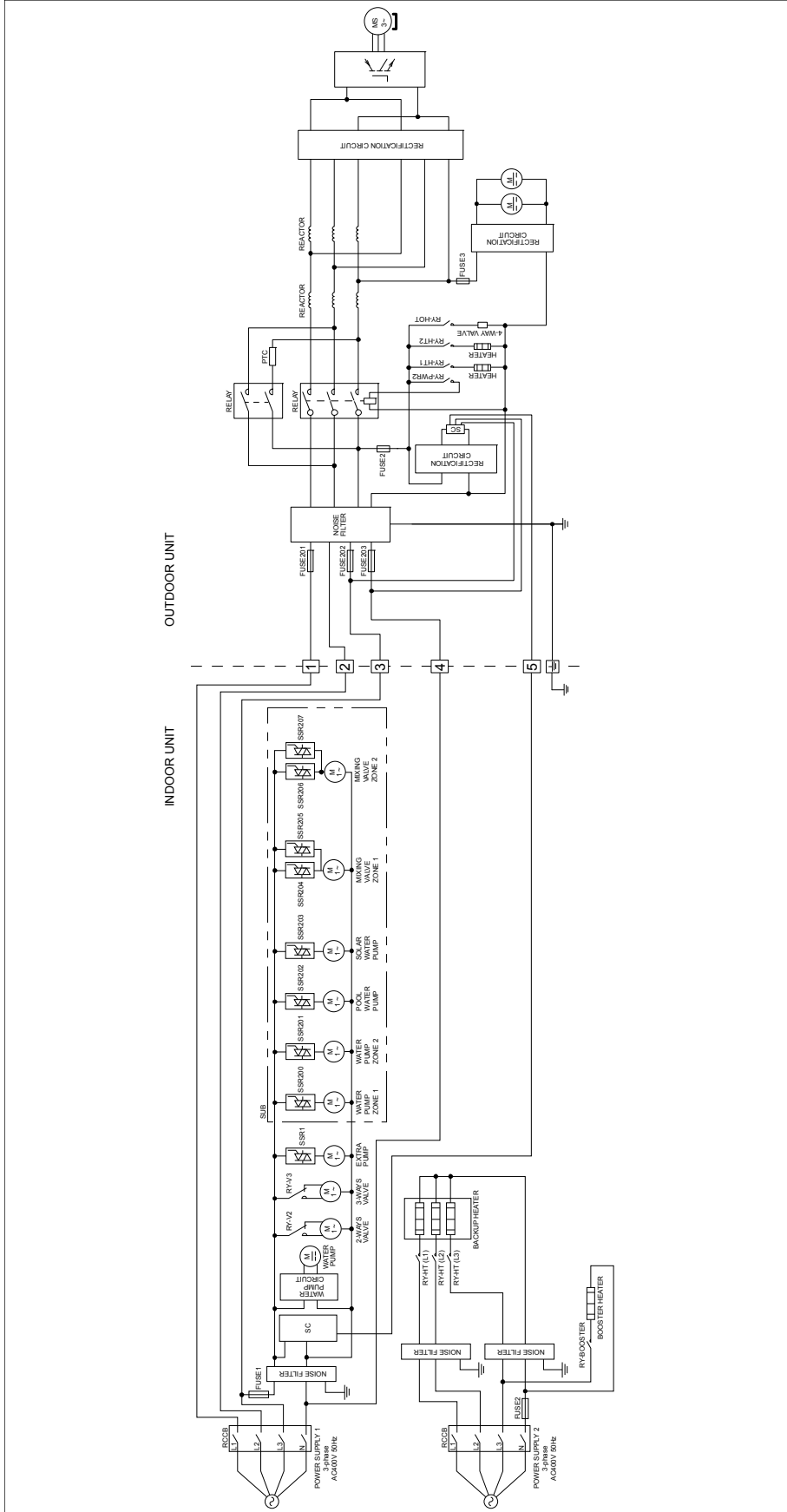

8. Wiring Connection Diagram

8.1 Indoor Unit

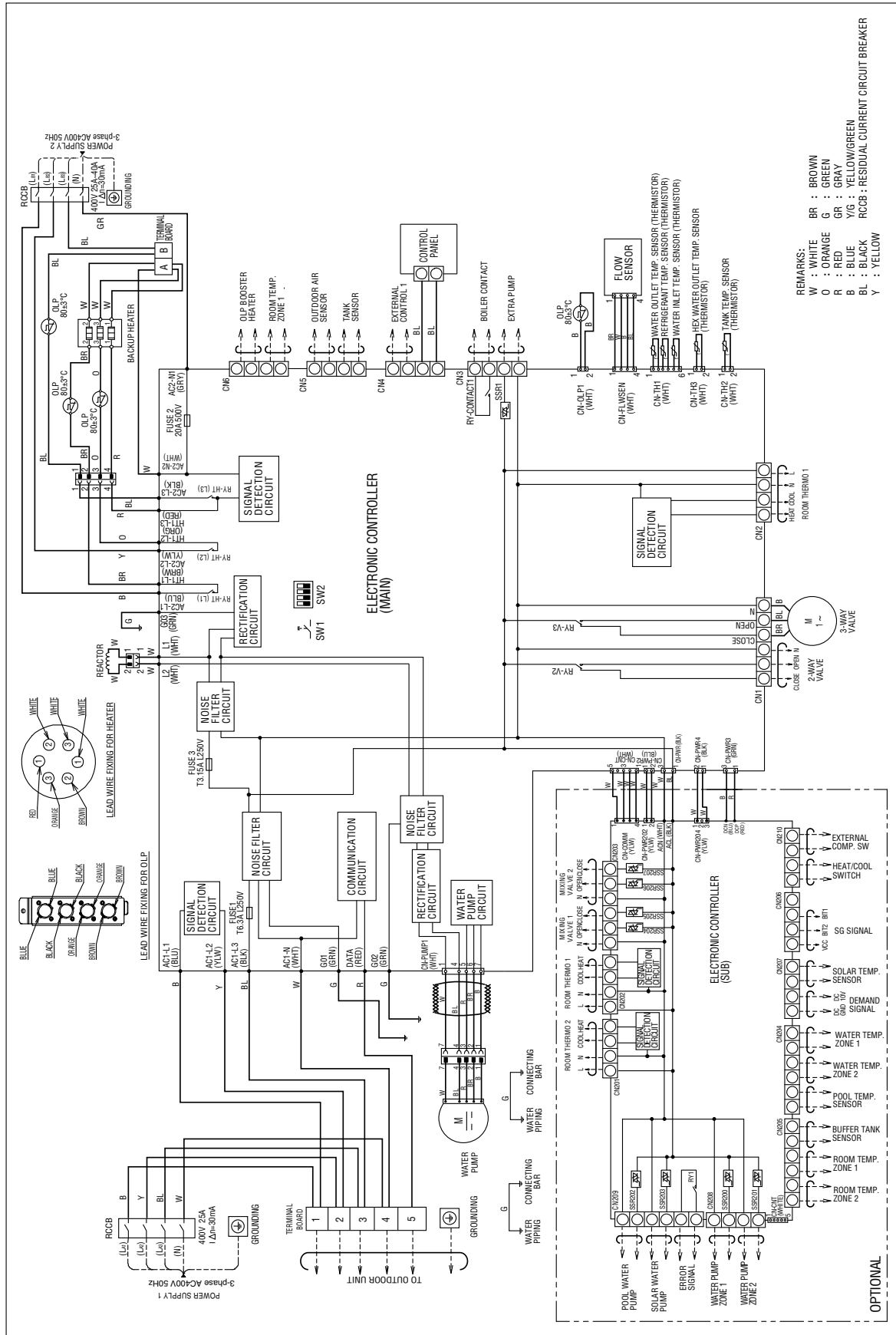

8.2 Outdoor Unit

8.2.1 WH-UQ09HE8 WH-UQ12HE8 WH-UX09HE8 WH-UX12HE8

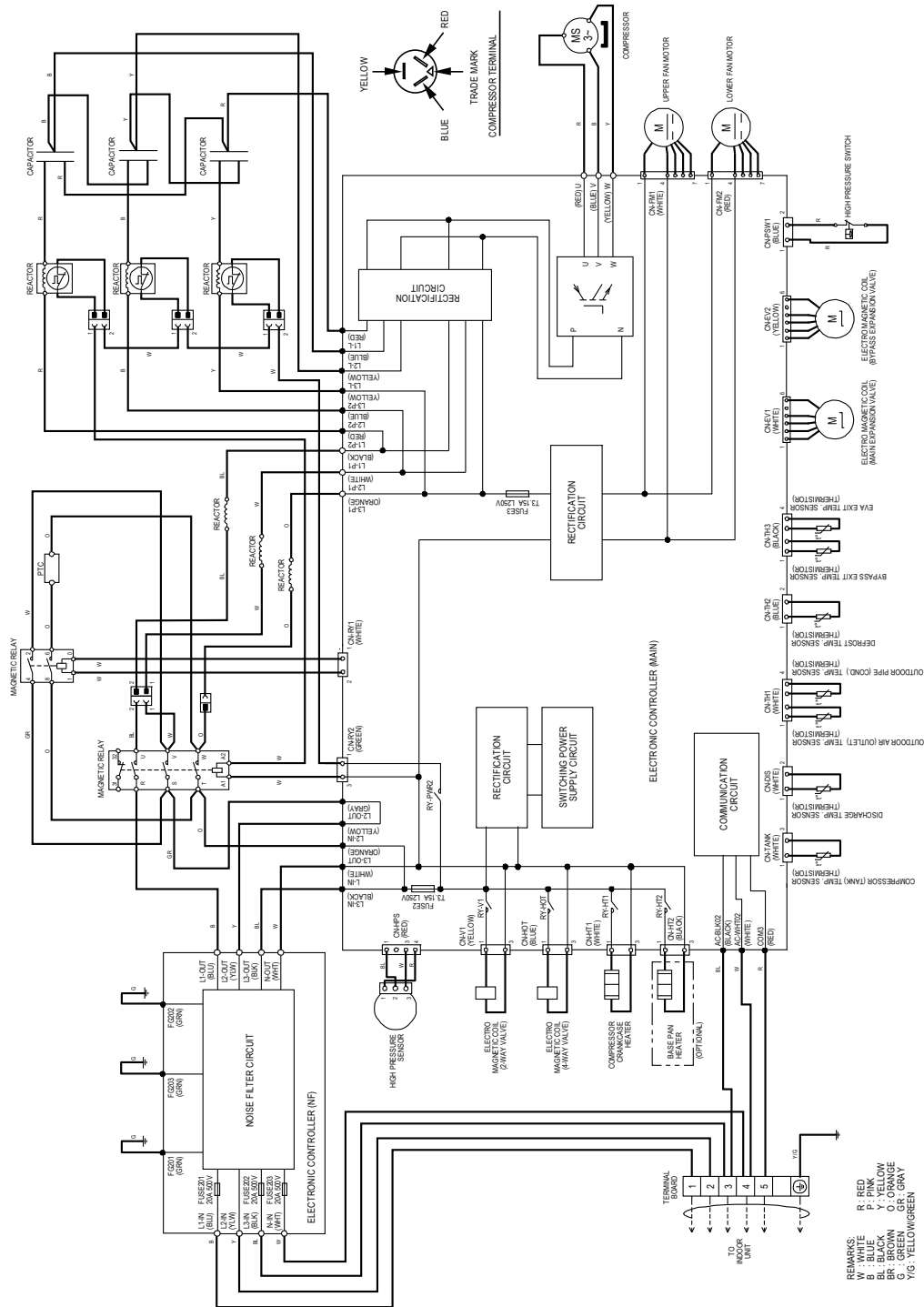

Resistance of Compressor Windings

MODEL	WH-UQ09HE8 / WH-UQ12HE8 / WH-UX09HE8 / WH-UX12HE8
CONNECTION	5JD420XBA22
U - V	1.083 Ω
V - W	1.096 Ω
U - W	1.123 Ω

Note: Resistance at 20°C of ambient temperature.

8.2.2 WH-UQ16HE8 WH-UX16HE8

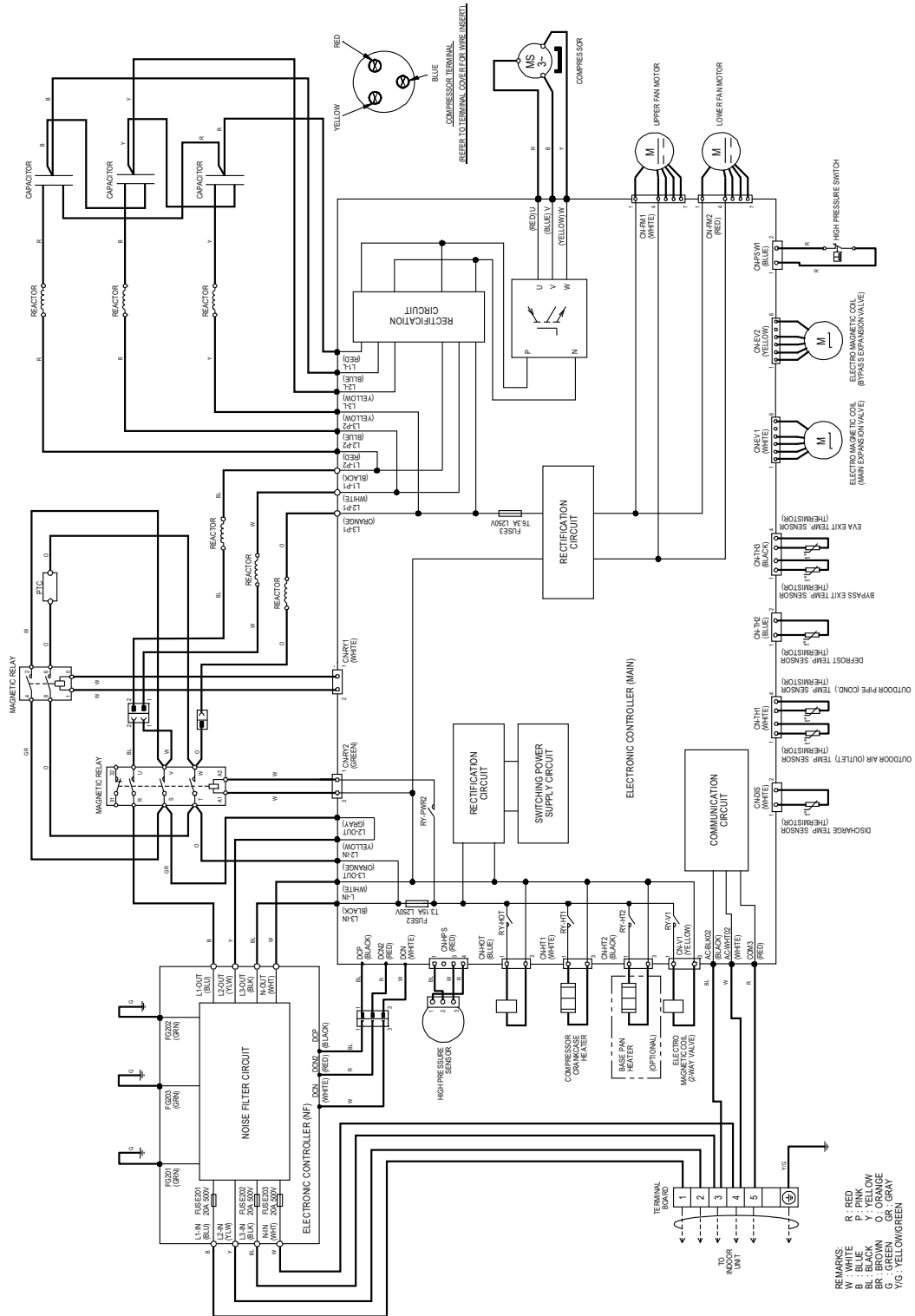

Resistance of Compressor Windings

MODEL	WH-UQ16HE8 / WH-UX16HE8
CONNECTION	5JD650XBA22
U - V	0.570 Ω
V - W	0.580 Ω
U - W	0.587 Ω

Note: Resistance at 20°C of ambient temperature.

8.2.3 WH-UD09HE8 WH-UD12HE8 WH-UD16HE8

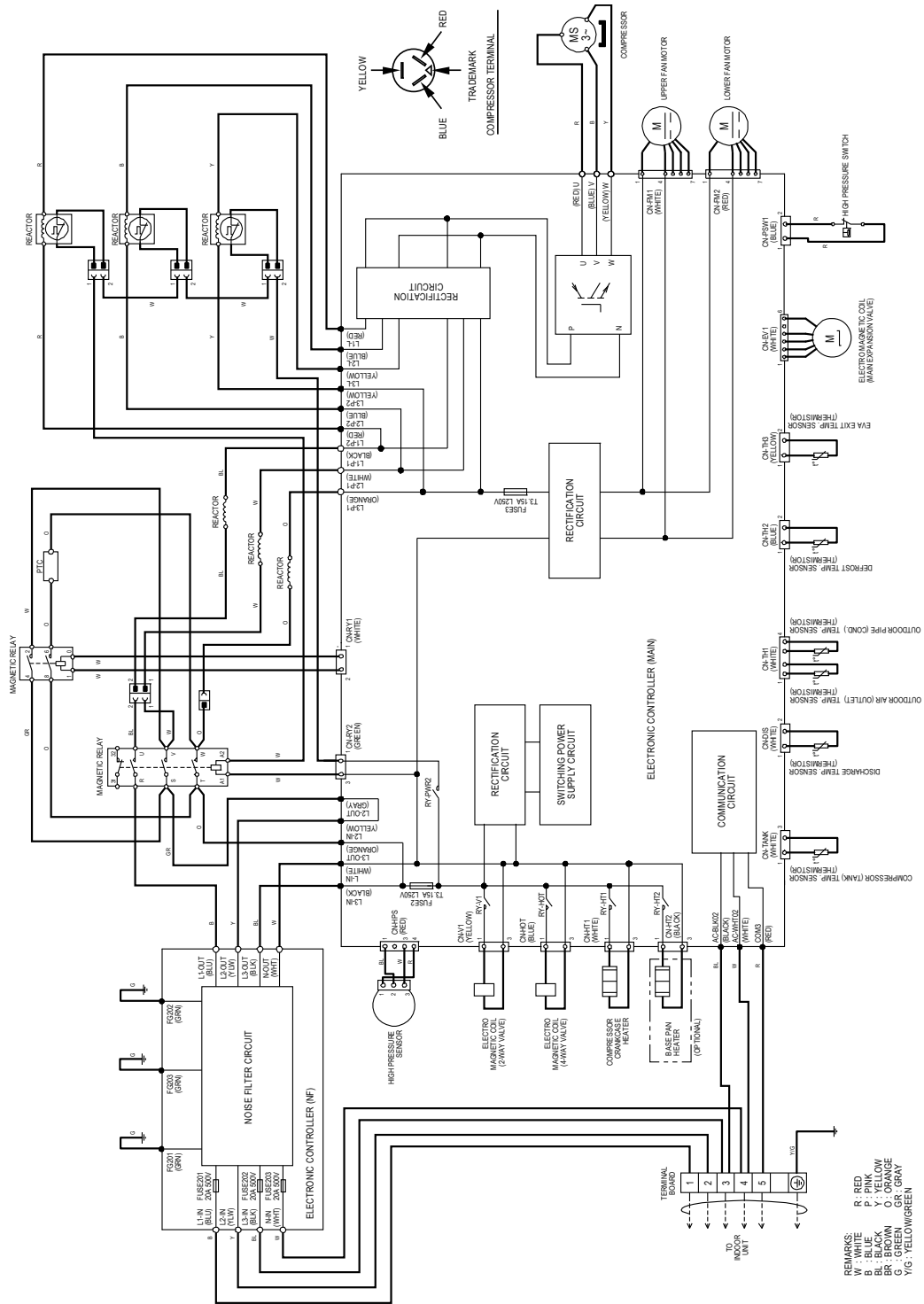

Resistance of Compressor Windings

MODEL	WH-UD09HE8 / WH-UD12HE8 / WH-UD16HE8
CONNECTION	5JD420XA22
U - V	1.083 Ω
U - W	1.123 Ω
V - W	1.096 Ω

Note: Resistance at 20°C of ambient temperature.

9. Electronic Circuit Diagram

9.1 Indoor Unit

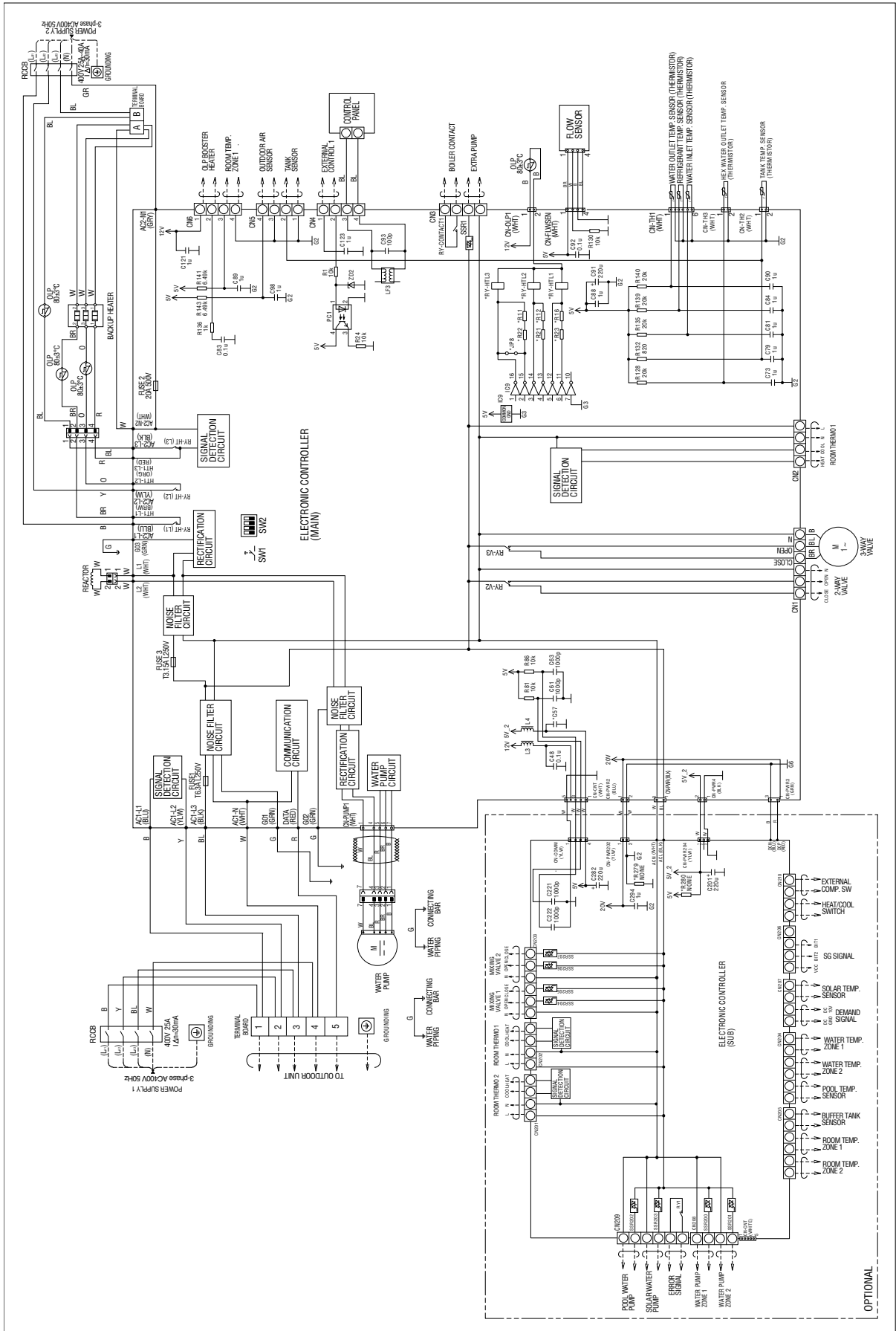

9.2 Outdoor Unit

9.2.1 WH-UQ09HE8 WH-UQ12HE8 WH-UX09HE8 WH-UX12HE8

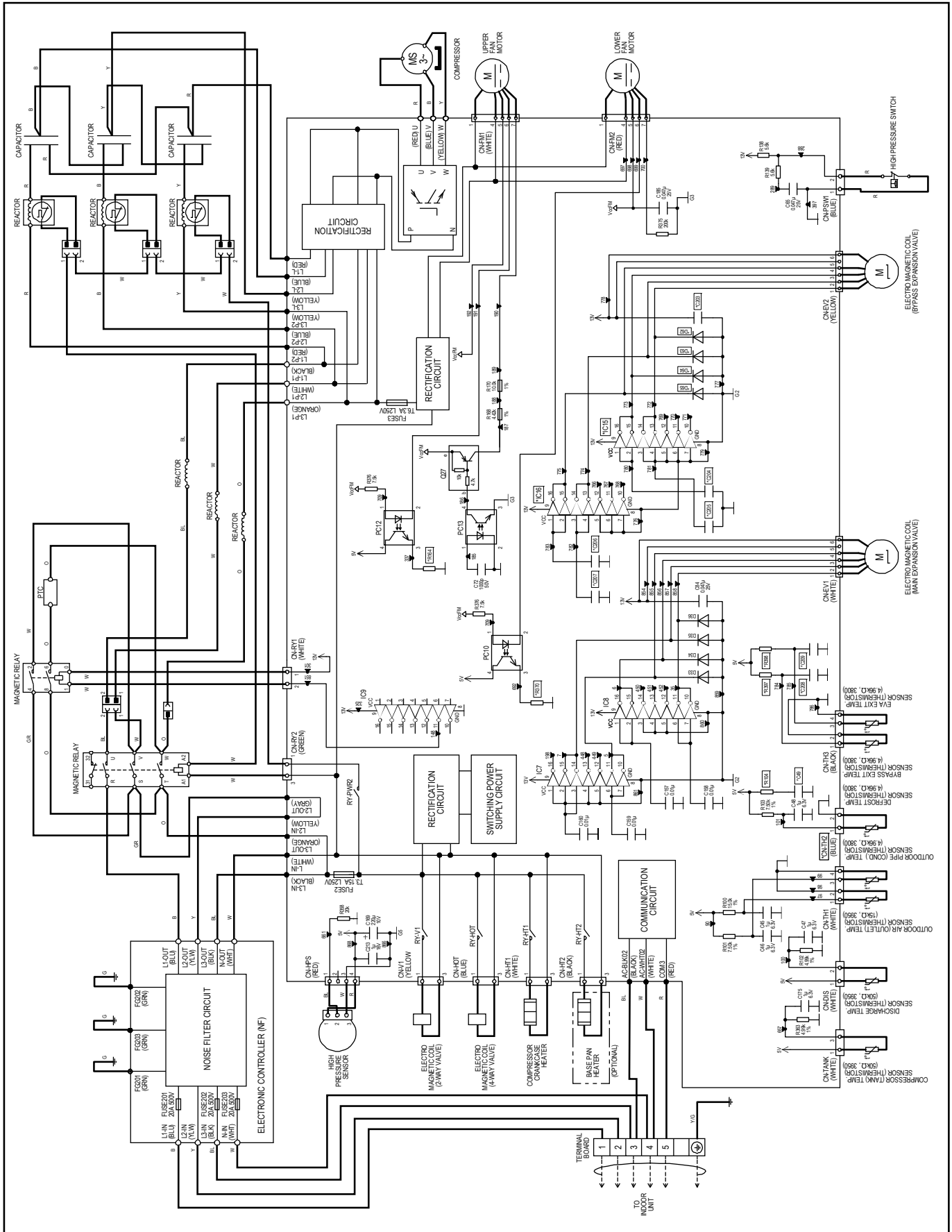

9.2.2 WH-UQ16HE8 WH-UX16HE8

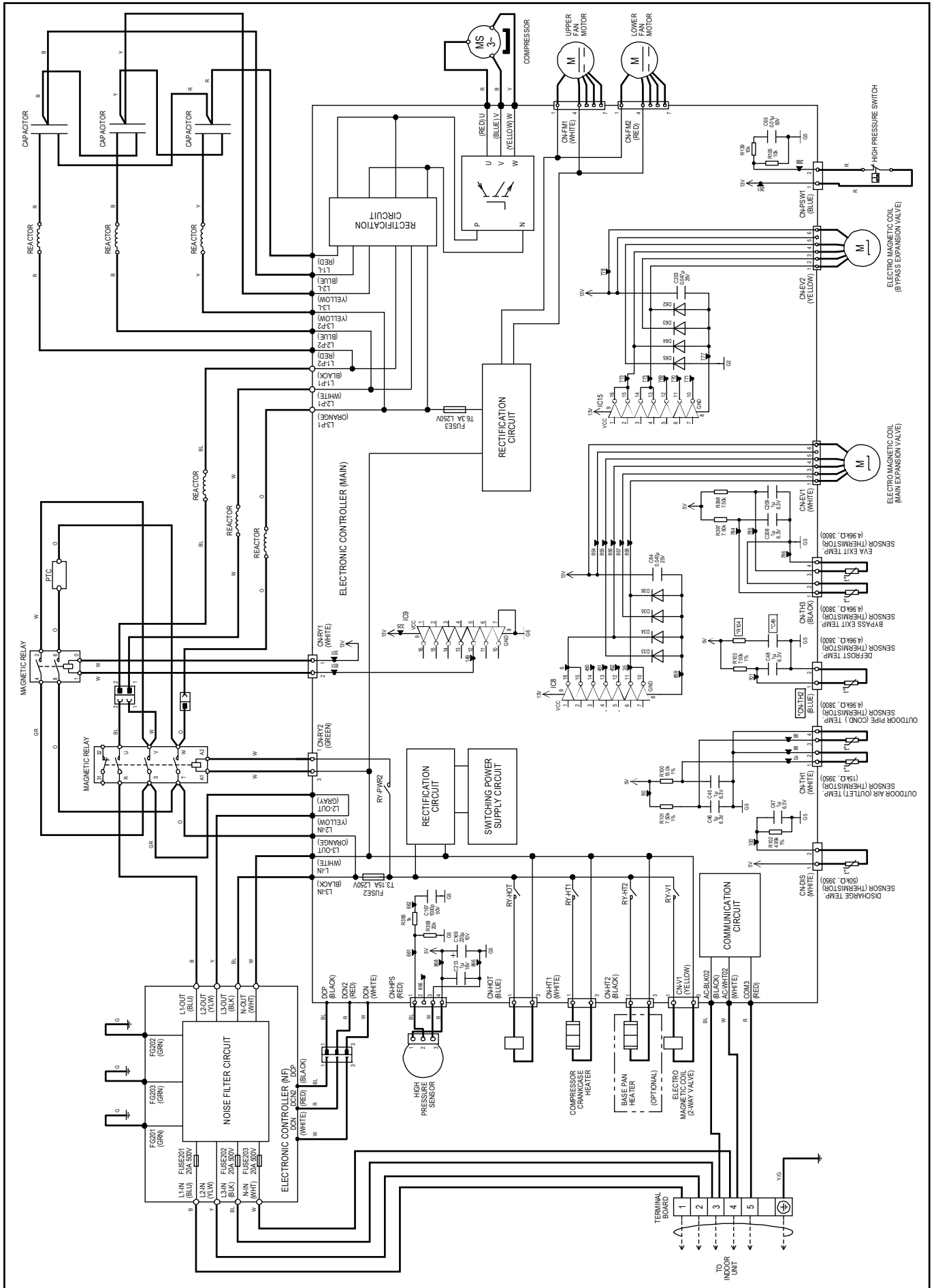

9.2.3 WH-UD09HE8 WH-UD12HE8 WH-UD16HE8

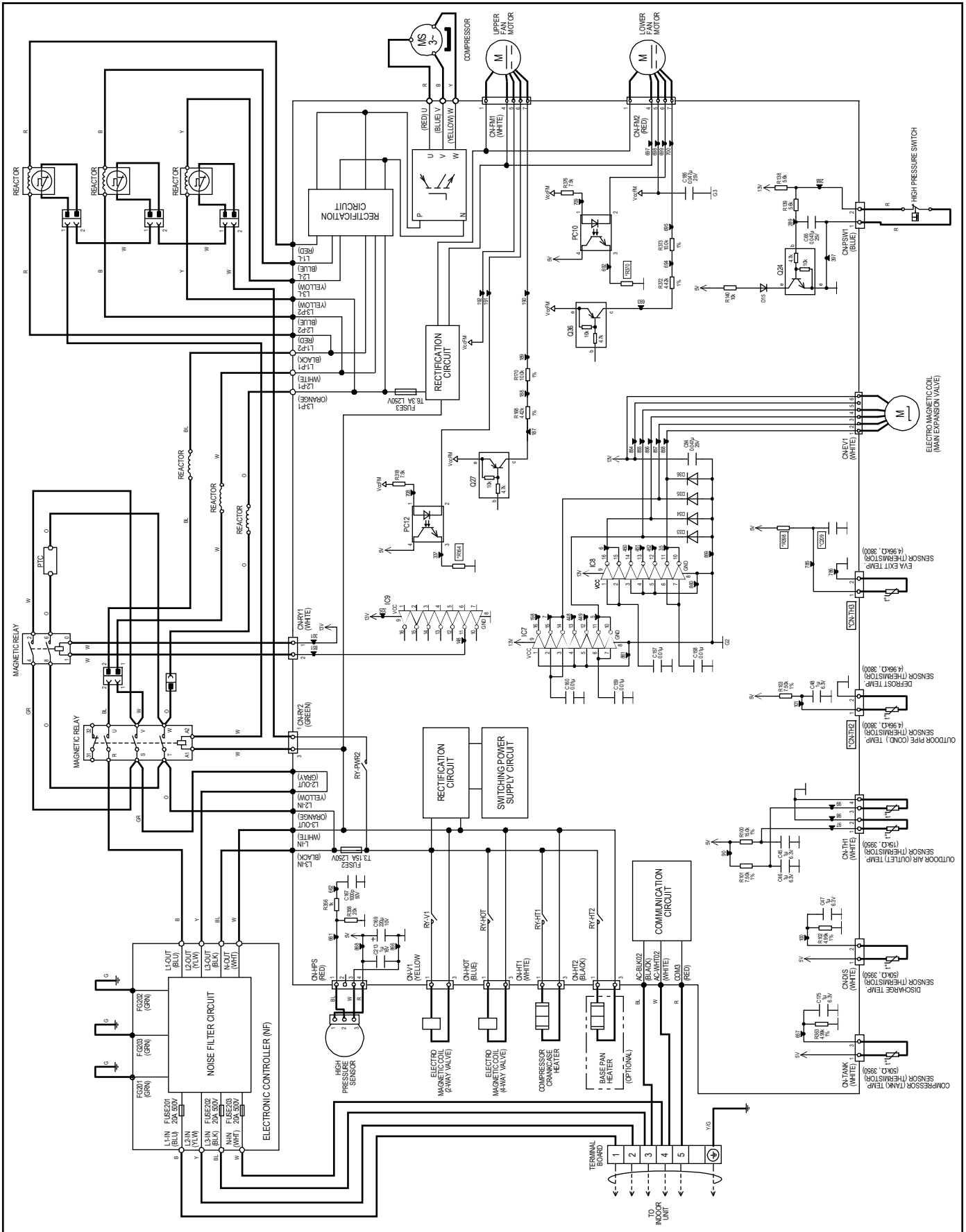

10. Printed Circuit Board

10.1 Indoor Unit

10.1.1 Main Printed Circuit Board

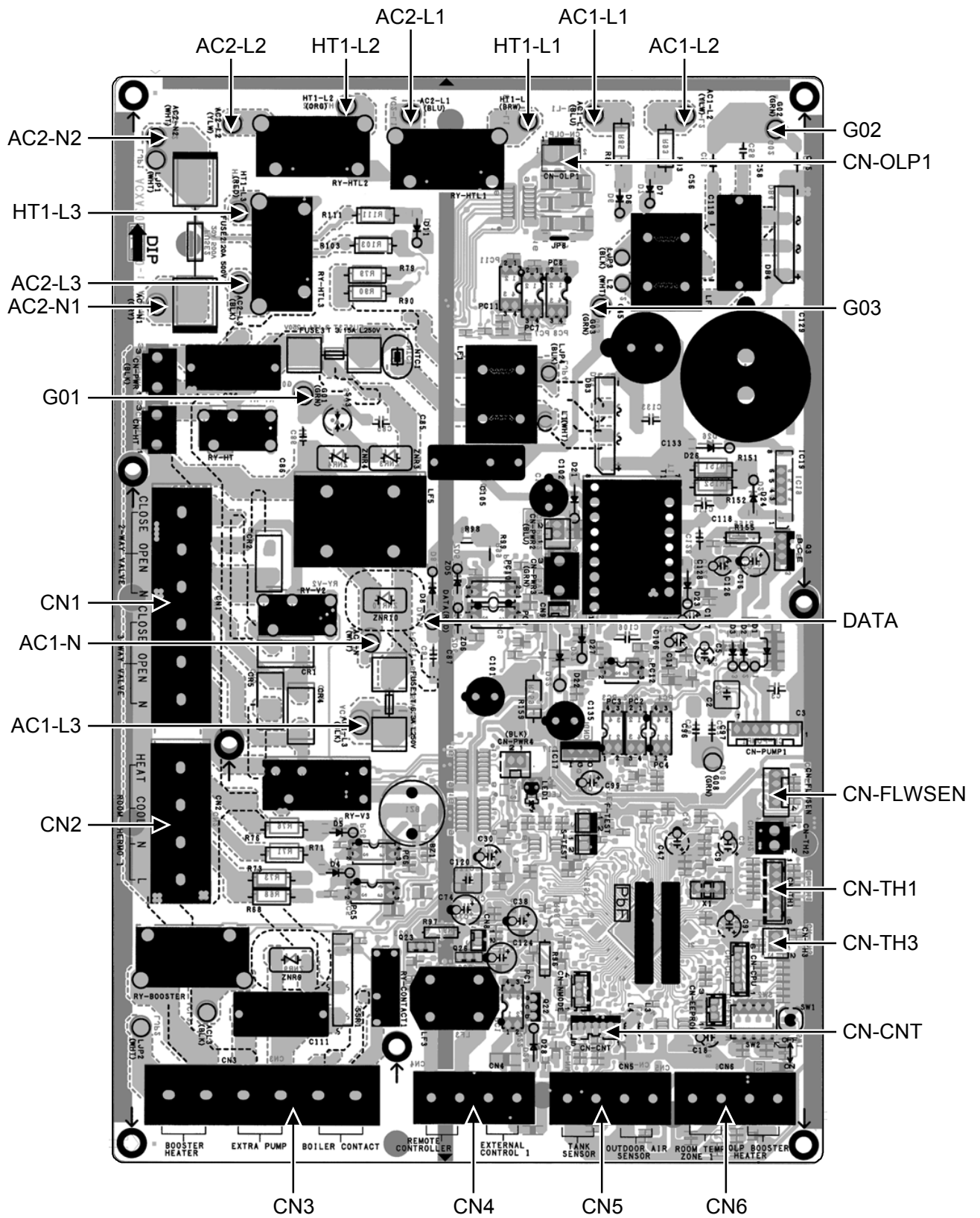

10.1.2 Sub Printed Circuit Board (Optional)

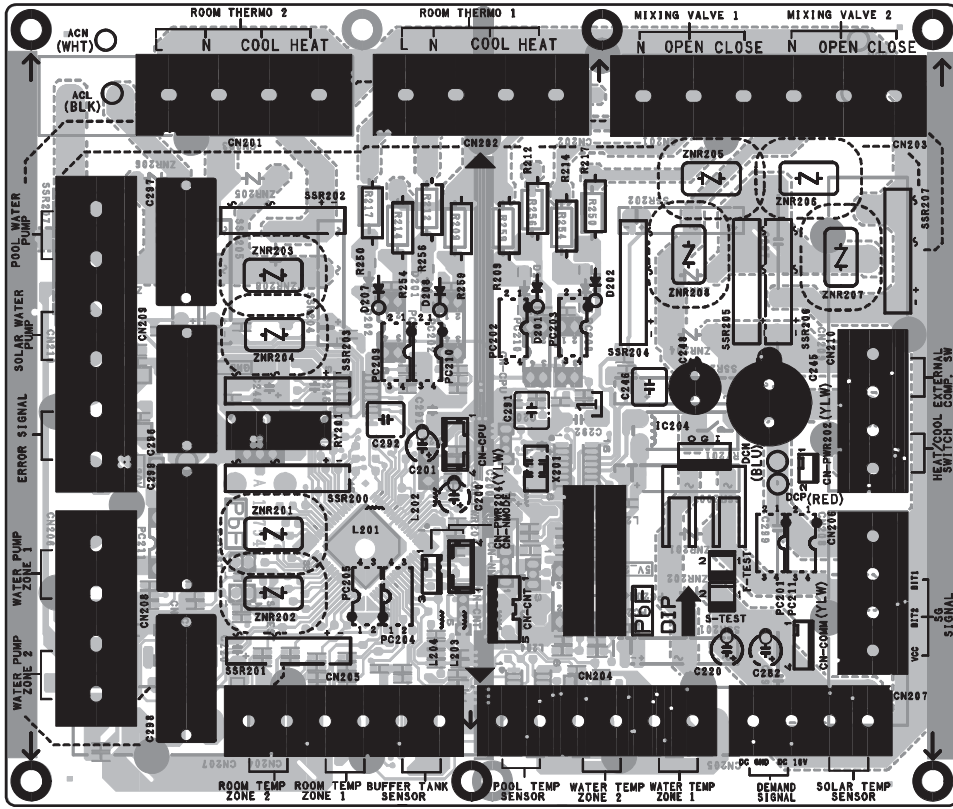

10.2 Outdoor Unit

10.2.1 Main Printed Circuit Board

10.2.1.1 WH-UX09HE8 WH-UX12HE8 WH-UQ09HE8 WH-UQ12HE8

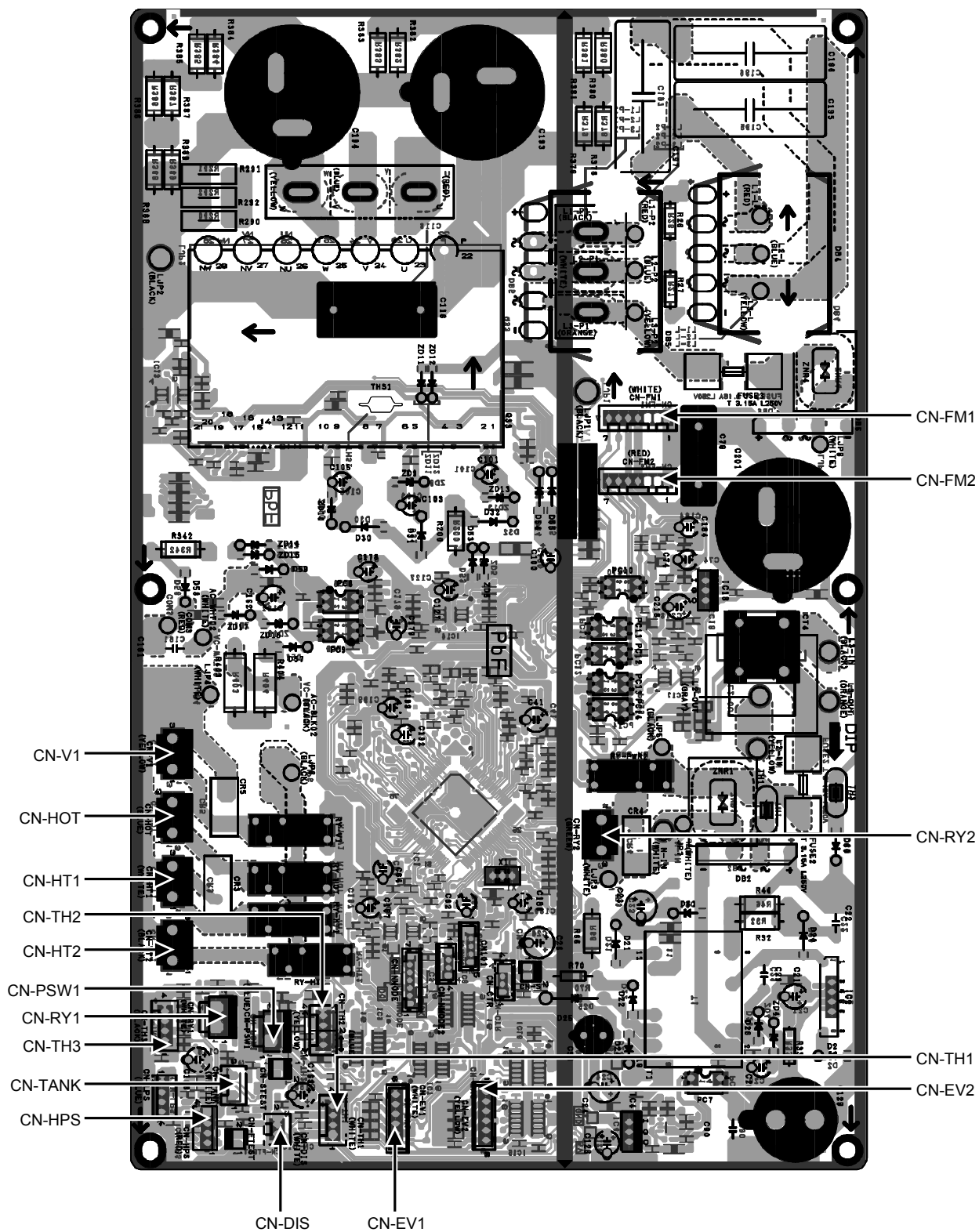

10.2.1.2 WH-UX16HE8 WH-UQ16HE8

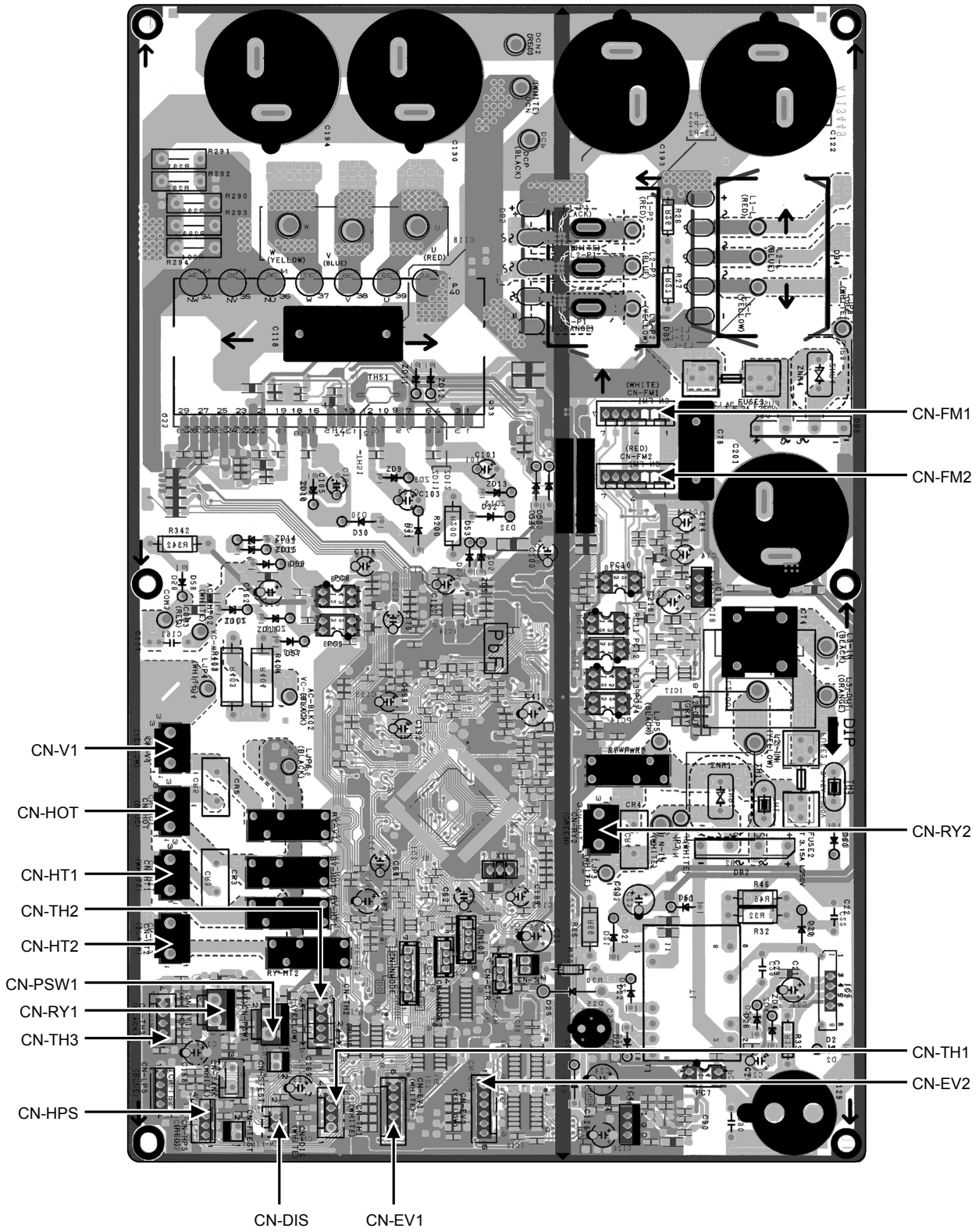

10.2.1.3 WH-UD09HE8 WH-UD12HE8 WH-UD16HE8

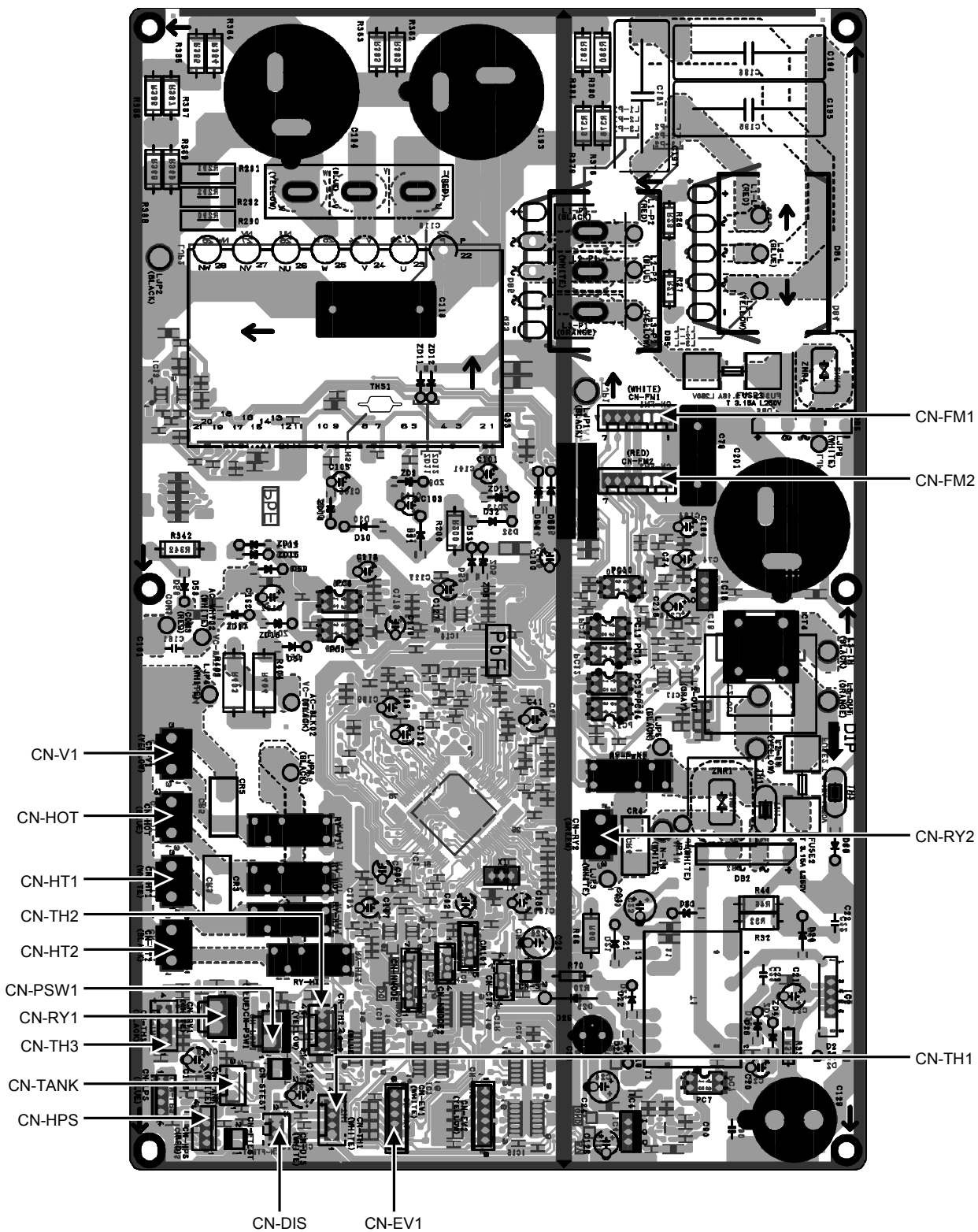

10.2.1.3.1 Noise Filter Printed Circuit Board

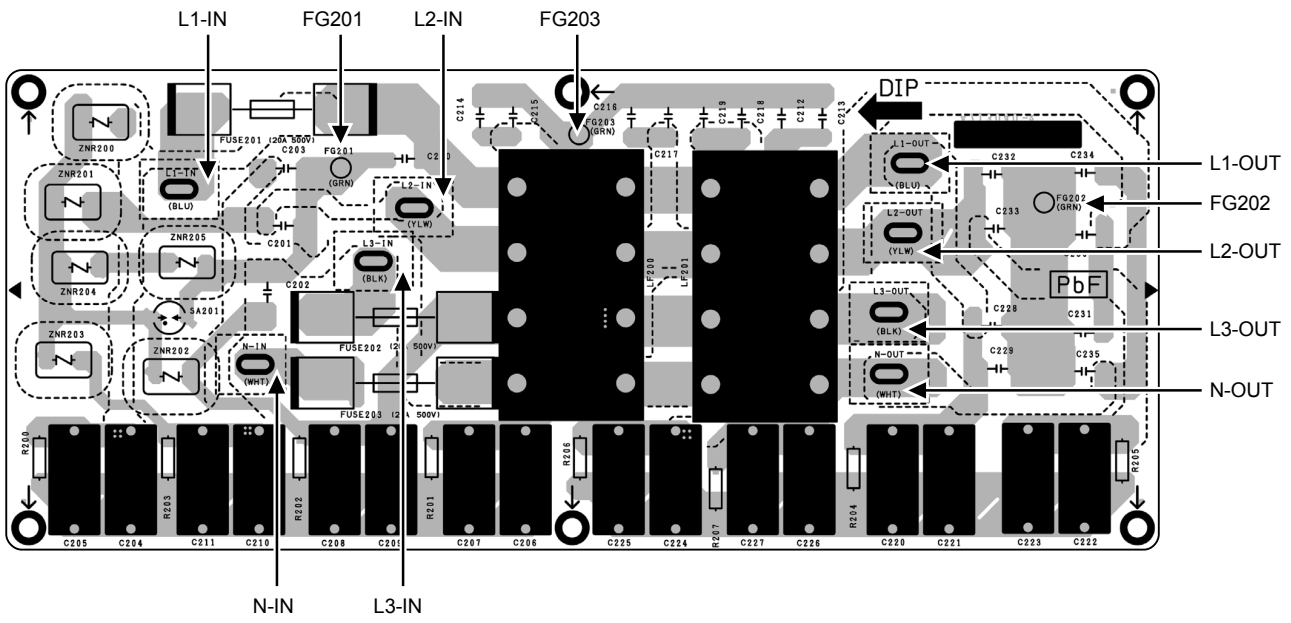

11. Operation and Control

11.1 Basic Function

Inverter control, which equipped with a microcomputer in determining the most suitable operating mode as time passes, automatically adjusts output power for maximum comfort always. In order to achieve the suitable operating mode, the microcomputer maintains the set temperature by measuring the temperature of the environment and performing temperature shifting. The compressor at outdoor unit is operating following the frequency instructed by the microcomputer at indoor unit that judging the condition according to internal water setting temperature and water outlet temperature.

11.1.1 Internal Water Setting Temperature

Once the operation starts, control panel setting temperature will be taken as base value for temperature shifting processes. These shifting processes are depending on the Air-to-Water Heat pump settings and the operation environment. The final shifted value will be used as internal water setting temperature and it is updated continuously whenever the electrical power is supplied to the unit.

11.1.2 Heating Operation

11.1.2.1 Thermostat Control

- Compressor is OFF when Water Outlet Temperature – Internal Water Setting Temperature > 2°C for continuously 3 minutes.
- Compressor is ON after waiting for 3 minutes, if the Water Outlet Temperature – Water Inlet Temperature (temperature at thermostat OFF is triggered) < -3°C.

11.1.2.2 Thermostat Control (Outdoor Ambient Temperature)

Stops provide heating to room side during high outdoor ambient condition.

Control content:

- Heating operation and water pump will turn OFF when outdoor ambient temperature > outdoor thermo off temperature + 3°C.
(Outdoor thermo off set temperature is set by control panel. Thermo off set temperature is between 5°C ~ 35°C)
- Heating operation will resume when Outdoor ambient temperature < Outdoor thermo OFF set temperature + 1°C.

11.1.2.3 Heat Mode Operation

Operation of heat pump provide heating capacity to room side by hot water through heating panel, floor heating or fan coil unit.

- 1 3 ways valve control:
 - 3 ways valve switch and fix to room side.
- 2 Heat pump operates follow normal heating operation.
- 3 Back up heater operate follow normal operation.
- 4 2 ways valve control:
 - 2 ways valve opens.

11.1.3 Cooling Operation

11.1.3.1 Thermostat control

- Compressor is OFF when Water Outlet Temperature – Internal Water Setting Temperature > -1.5°C for continuously 3 minutes.
- Compressor is ON after waiting for 3 minutes, if the Water Outlet Temperature – Water Inlet Temperature (temperature at thermostat OFF is triggered) > 3°C.

11.1.3.2 Cool Mode Operation

- 1 3 ways valve control:
 - 3 ways valve switch and fix to cooling side.
- 2 Heat pump operates follow normal cooling operation.
- 3 Back up heater DOES NOT operate during cool mode.
- 4 2 ways valve control:
 - 2 ways valve is closed.

11.1.4 Target Water Temperature Setting

11.1.4.1 Target Water Temperature Control of Standard System (Optional PCB not connected)

There are 2 types of temperature control selection which are Compensation and Direct.

- Temperature control type selection by installer:
 - 1 Compensation : WLo, WHi, ODLo, ODHi can be set at installer menu.
 - 2 Direct : Direct Water Temperature Set
- Remote control setting by user:
 - 1 Compensation : Shift value $\pm 5^{\circ}\text{C}$ from the compensation curve
 - 2 Direct : Direct water temperature set change

*This setting only able to set when room sensor select as Water Temperature.

*Instead of water temperature, user will set target room temperature when room sensor select as Room Thermistor OR Internal Room Thermostat.

- Target water temperature is calculated as below condition.
 - Target water temperature = A (Base temperature) + B (shift temperature)

A (Base Temperature)	Compensation	Direct
	Value from the curve + User shift value set	Direct value from user setting

- B (shift temperature) value is depend on the room sensor selection at remote controller as below table:

B (Shift Temp.)	B shift value depend on the room sensor selection at remocon as table below
Sensor selection	
Water temperature	B = 0
External Room thermostat	B = 0
Internal Room thermostat & Room Thermistor	Cool Mode: B = 0 ; when Zone OFF or Zone Room Thermo OFF B = B = 1* (room set temp (R/C) – actual room temp) Max/Min Regulation of B: (Max = 5°C ; Min = -5°C)
	Heat Mode: B = 0 ; when Zone OFF or Zone Room Thermo OFF B = follow Heating PI control contents

- Maximum/minimum regulation of Target Water Temperature

	Heating		Cooling
	WH-UD09HE8, WH-UD12HE8, & WH-UD16HE8	WH-UX09HE8, WH-UX12HE8, & WH-UX16HE8	
Max	55°C	55°C (Below Ambient -15°C) * 60°C (Below Ambient -10°C) *	20°C
Min	20°C		5°C

* Between outdoor ambient -10°C and -15°C, max target decreases gradually from 60°C to 55°C.

Compensation Type: (Operation under Heat Mode and Cool Mode)

- The set temperature defines the parameters for the ambient (Outdoor temperature) dependent operation of the unit. The water temperature is determined automatically depending on the outdoor temperature. Default setting is the colder outdoor temperature will result in warmer water and vice versa. The user has the possibility to shift up and shift down the target water by remote control setting.

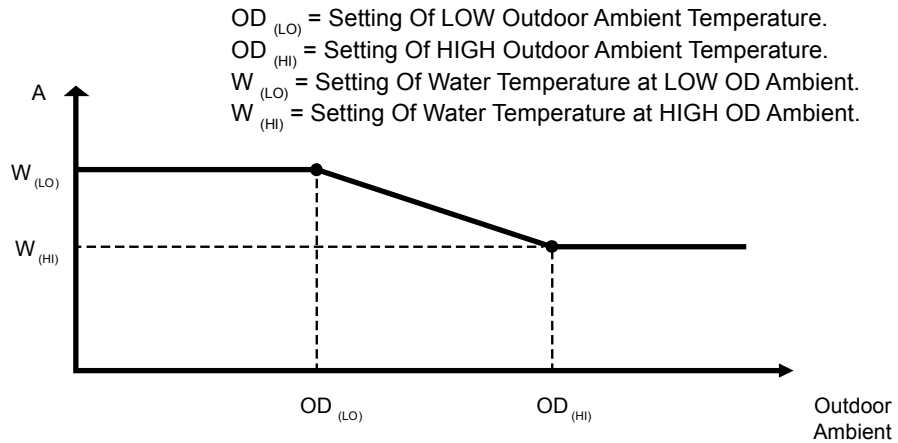

- Outdoor ambient is updated every 30 minutes when operation ON.
- Setting water outlet temperature always follow $W_{(LO)}$ or $W_{(HI)}$ whenever is higher if outdoor ambient sensor or indoor communication error happen.

However, when powerful mode is requested by remote control during heating mode, the higher value of HLo or Whi will be used for A calculation.

* There are 2 compensation curves (for heating and cooling). During heating mode, the heating curve is used and during cooling mode, the cooling curve is use.

- Compensation curve set shift value:

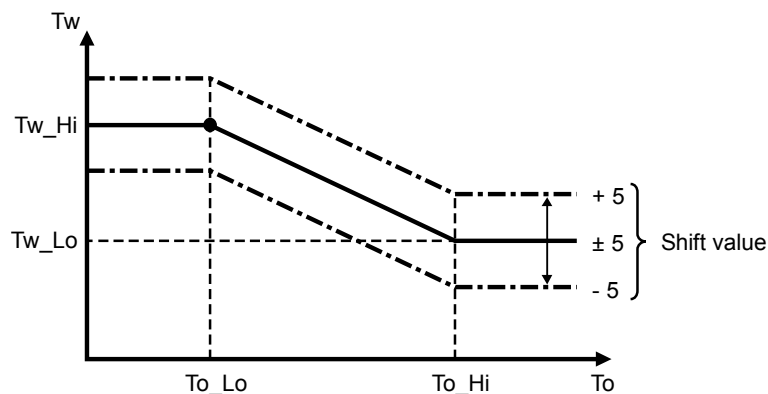

11.1.5 Target Water Temperature at Extension System (Optional PCB is connected)

Target water temperature is calculated as below.

- Heat Mode:
 - When buffer tank selection is "YES:"
Target water temperature = Target buffer tank temperature + [2°C]
 - When buffer tank selection is "NO"
 - If both zone 1 and zone 2 is active
Target Water Temperature = Higher zone target water temperature of Zone 1 and Zone 2.
 - If only one zone is active
Target Water Temperature = Zone target water temperature of active zone.

- Cool mode:
 - When buffer tank selection is “YES”
 - If both zone 1 and zone 2 active
Target Water Temperature = Lower Zone Target Water Temperature of Zone 1 and Zone 2 + [-3°C]
 - If only one zone is active
Target Water Temperature = Zone Target Water Temperature of active zone + [-3°C]
 - When buffer tank selection is “NO”
 - If both zone 1 and zone 2 active
Target Water Temperature = Lower Zone Target Water Temperature of Zone 1 and Zone 2
 - If only one zone is active
Target Water Temperature = Zone Target Water Temperature of active zone

*Cool Mode does not have SG ready control

11.1.6 Target Zone Water Temperature Control

Purpose:- To control zone mixing and zone pump according to the zone sensor temperature

11.1.6.1 Target Zone 1 water temperature setting control

- Start condition
 - Heating zone 1 is ON by remote control or Timer or Auto Mode **OR**
 - Cooling zone 1 is ON by remote control or Timer or Auto Mode.
- Cancel condition
 - Heating zone 1 is OFF by remote control or Timer or Auto mode **AND**
 - Cooling zone 1 is OFF by remote control or Timer or Auto mode.
- Target Zone 1 water temperature is calculated as below condition.
 - Target Zone 1 water temperature = A (Base temperature) + B (shift temperature)

A (Base Temperature)	Compensation	Direct
		Value from the curve + User shift value set

* During heat mode and compensation select, if powerful mode is activated, higher value of WLo or WHi will be use as curve value.

- B (shift temperature) value is depend on the room sensor selection at remote controller as below table:

B (Shift Temp.)	B shift value depend on the room sensor selection at remocon as table below
Sensor selection	
Water temperature	B = 0
External Room thermostat	B = 0
Internal Room thermostat & Room Thermistor	Cool Mode: B = 0 ; when Zone OFF or Zone Room Thermo OFF B = B = 1* (room set temp (R/C) – actual room temp) Max/Min Regulation of B: (Max = 5°C ; Min = -5°C)
	Heat Mode: B = 0 ; when Zone OFF or Zone Room Thermo OFF B = follow Heating PI control contents
Pool Function Selected	B = Delta value setting from remocon

* B = 0 regardless of which sensor selection, if SHP control bit is enable except Pool function select (maintain Pool “B” value)

** Pool function also can be select at Zone 1 when optional PCB is connected and Zone 1 system is select.

- Maximum/minimum regulation of Target Water Temperature.

	Heating		Cooling
	WH-UD09HE8, WH-UD12HE8, & WH-UD16HE8	WH-UX09HE8, WH-UX12HE8, & WH-UX16HE8	
Max	55°C	55°C (Below Ambient -15°C) * 60°C (Below Ambient -10°C) *	20°C
Min	20°C		5°C

* Between outdoor ambient -10°C and -15°C, max target decreases gradually from 60°C to 55°C.

- Target Zone 1 Water Temperature (Heat mode only) during SG ready control
 - If buffer tank selection is “NO” then following shift is carried out.
 - While digital input is “10” or “11” then,
Final Target Zone 1 water temperature
= Target Zone 1 water temperature* (SG ready % setting (remote control menu))%
 - If buffer tank selection is “YES”
 - No shift of Target Zone 1 Water Temperature. Target Buffer Tank Temperature will change accordingly.
* Refer to “Buffer tank temperature control”

11.1.6.2 Target Zone 2 water temperature setting control

- Start condition
 - Heating zone 2 is ON by remote control or Timer or Auto Mode **OR**
 - Cooling zone 2 is ON by remote control or Timer or Auto Mode.
- Cancel condition
 - Heating zone 2 is OFF by remote control or Timer or Auto mode **AND**
 - Cooling zone 2 is OFF by remote control or Timer or Auto mode.
- Target Zone 2 water temperature is calculated as below condition.
 - Target Zone 2 water temperature = A (Base temperature) + B (shift temperature)

A (Base Temperature)	Compensation	Direct
	Value from the curve + User shift value set	Direct value from user setting

* During heat mode and compensation select, if powerful mode is activated, higher value of WLo or WHi will be use as curve value.

- B (shift temperature) value is depend on the room sensor selection at remote controller as below table:

B (Shift Temp.)	B shift value depend on the room sensor selection at remocon as table below
Sensor selection	
Water temperature	B = 0
External Room thermostat	B = 0
Internal Room thermostat & Room Thermistor	Cool Mode: B = 0 ; when Zone OFF or Zone Room Thermo OFF B = B = 1* (room set temp (R/C) – actual room temp) Max/Min Regulation of B: (Max = 5°C ; Min = -5°C)
	Heat Mode: B = 0 ; when Zone OFF or Zone Room Thermo OFF B = follow Heating PI control contents
Pool Function Selected	B = Delta value setting from remocon

* B = 0 regardless of which sensor selection, if SHP control bit is enable except Pool function select (maintain Pool “B” value)

** Pool function also can be select at Zone 2 when optional PCB is connected and Zone 2 system is select.

- Maximum/minimum regulation of Target Water Temperature.

	Heating		Cooling
	WH-UD09HE8, WH-UD12HE8, & WH-UD16HE8	WH-UX09HE8, WH-UX12HE8, & WH-UX16HE8	
Max	55°C	55°C (Below Ambient -15°C) * 60°C (Below Ambient -10°C) *	20°C
Min	20°C		5°C

* Between outdoor ambient -10°C and -15°C, max target decreases gradually from 60°C to 55°C.

- Target Zone 2 Water Temperature (Heat mode only) during SG ready control
 - If buffer tank selection is "NO" then following shift is carried out.
 - While digital input is "10" or "11" then,
Final Target Zone 2 water temperature
= Target Zone 1 water temperature* (SG ready % setting (remote control menu))%
 - If buffer tank selection is "YES"
 - No shift of Target Zone 2 Water Temperature. Target Buffer Tank Temperature will change accordingly.
* Refer to "Buffer tank temperature control"

11.1.6.3 Zone Temperature Control Contents

- During Standard System (Optional PCB not connected)
 - Only 1 zone temperature control is available
 - This zone room temperature is control by either one of the 4 room sensor (Room Th, Int/Ext Room Thermostat, Water temperature)
 - Target Zone Water Temperature is calculated based on selected temperature control type (Compensation or Direct) and selected room sensor. Target Water Temperature will set same as Target Zone Water Temperature
 - Target Water Temperature is the temperature for heat pump to operate refer to indoor water outlet sensor.
 - Heat pump and water pump OFF when ROOM Thermo OFF (Zone thermo OFF by Room Th or Room Thermostat).

* There will be no zone sensor connected to zone 1 (No zone sensor error), mixing valve and zone pump will not operate.

- During Extension System (Optional PCB connected)
- Buffer Tank connection select "NO" &
 - One zone system is select
 - This zone room temperature control by either one of the 4 room sensor (Room Th, Int/Ext Room Thermostat, Water temp.)
 - Target Zone Water Temperature calculate base on selected temperature control type (Compensation or Direct) and selected room sensor.
 - Target Water Temperature will set same as Target Zone Water Temperature
 - Target Water Temperature is a temperature for heat pump to operate refer to indoor water outlet sensor.
 - Heat pump and water pump OFF when ROOM Thermo OFF (Zone thermo OFF by Room Th or Room Thermostat).

* There will be no zone sensor connected to zone 1 (No zone sensor error), mixing valve and zone pump will not operate.

- 2 zone system select
 - Each zone room temperature is control by each sensor which select from either one of the 4 room sensor
 - Target Zone 1 & 2 Water Temperature is calculated based on selected temperature control type (Compensation or Direct) and selected room sensor.
* Zone Mixing Valve & Zone pump will operate to achieve Target Zone Water Temperature which refer to zone sensor.
* Zone Sensor will detect if zone sensor is open or short.
 - Target Water Temperature will set same as the active & higher zone water temperature setting. (When cooling mode, lower zone water temp setting)
 - Target Water Temperature is the temperature for heat pump to operate refer to indoor water outlet sensor.
 - Heat pump and water pump OFF when ROOM Thermo OFF (Both Zone thermo OFF by Room Th or Room Thermostat).

- Buffer Tank Connection select "YES" &
 - 1 zone system or 2 zone system select
 - Each zone control by each sensor which select from either one of the 4 room sensor
 - Target Zone 1 & 2 Water Temperature calculate base on selected temperature control type (Compensation or Direct) and selected room sensor. Each zone have their own Target Zone Water Temperature.
 - * Zone Mixing Valve & Zone pump will operate to achieve each Target Zone Water Temperature which refer to zone sensor
 - * Zone Sensor will detect if zone sensor is open or short.
 - Target Buffer Tank Temperature will be set as active & higher zone water temperature setting + Buffer Delta T. (Heating) Target Buffer Tank Temperature will be set as active & lower zone water temperature setting (Cooling).
 - Target Water Temperature will set as Target Buffer Tank Temperature + [2°C] (Heating) Target Water Temperature will set as Lower or Active Target Zone Water Temp. + [-3°C] (Cooling)
 - Target Water Temperature is a temperature for heat pump to operate refer to indoor water outlet sensor.
 - Heat pump and water pump OFF when ROOM thermo OFF
 - Heat mode: ROOM thermo OFF (Buffer Tank Temperature > Target Buffer Tank + [0°C])
 - Cool mode: ROOM Thermo OFF (Both Zone thermo OFF by Room Th or Room Thermostat)

11.1.7 Auto Mode Operation

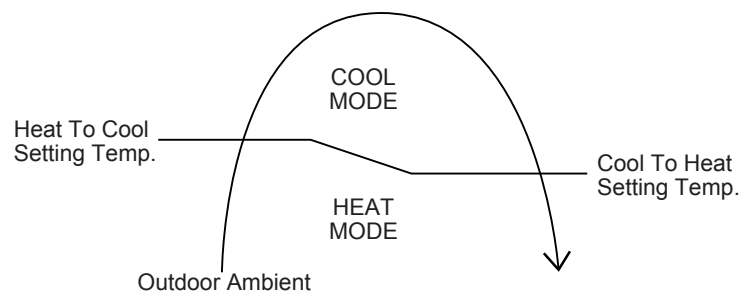

- Control details:
 - To enable the unit to operate either heat or cool mode automatically, heat to cool set temperature and cool to heat set temperature can be set by control panel.
 - Automatic operation is judged based on control panel setting temperature and outdoor ambient temperature.
 - * Minimum setting of heat to cool set temperature is 1°C higher than cool to heat set temperature.
- Judgement control:
 - If outdoor ambient temperature < Heat to Cool Set Temperature, unit will operate in Heat Mode or else the unit will operate in Cool Mode.
 - If current operation is Cool mode, outdoor ambient temperature > Cool to Heat Temperature, unit will maintain Cool mode operation or else the unit will operate Heat mode.
 - If current operation is Heat mode, outdoor ambient temperature >Heat to Cool Temperature, unit will maintain Heat mode operation or else the unit will operate Cool mode.
 - Every 60 minutes the outdoor ambient temperature is judged.
 - When Auto + Tank mode is selected, operation mode switching is judged by both outdoor ambient temperature and indoor air temperature.

11.1.8 Auto Cooling Mode Operation Limit

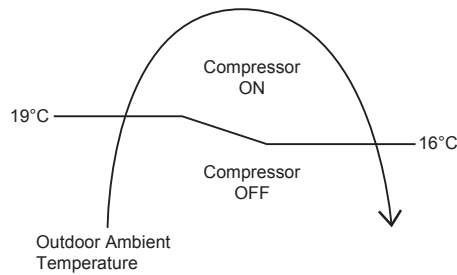

- Auto Mode Cooling Only operation will start once the outdoor ambient temperature reaches 19°C and compressor will continue to run until the outdoor ambient temperature drops to 16°C.
- Due to this limitation, If Heat to Cool temperature is set lower than 19°C, the compressor will not operate until the outdoor ambient temperature reaches 19°C or higher.

11.1.9 Tank Mode Operation

- 3 ways valve direction
 - 3 ways valve switch to tank side during Tank Thermo ON condition. Switch 3 ways valve to room side when tank achieve Tank Thermo OFF temperature.

- Tank Thermo ON/OFF Characteristic
 - Tank Thermo OFF

Case 1: Internal Tank Heater is select and Tank Heater ON

- Tank temperature > Tank Set Temperature continuously for 15 seconds.
- Water outlet >75°C

- Case 2: Tank Heater OFF OR External Heater is select

- When heat pump OFF due to water thermost & Tank temperature > Tank water set temperature for continuously 20 seconds. **OR**
- Tank temperature > Tank set temperature + 1°C for continuously 20 seconds.

- Tank Thermo ON

Case 1: Internal Tank Heater is select and Tank Heater ON

- Tank temperature < Tank set temperature + R/C (Tank re-heat temperature)

Case 2: Tank Heater select OFF OR External Heater is select

- Tank temperature < Tank water set temperature + R/C (Tank re-heat temperature)

* When tank thermo ON, water pump will ON for 3 minutes then only heat pump turn ON.

* Tank water set temperature = tank set temperature or 51°C whichever lower.

- 2 ways valve close
- Heat pump Thermostat Characteristic
 - Heat pump Water Outlet set temperature is set to below table:

Outdoor ambient temperature	Heat pump water outlet temperature
< 5°C	55°C
> 5°C	57°C

Characteristic of heat pump thermos ON/OFF under tank mode condition:

Water Outlet Thermo Condition

- Heat pump thermos OFF temperature:
 - 1 Heat pump thermo OFF temperature = Target Water outlet temperature + (2°C)
 - 2 Water outlet temperature > heat pump thermo OFF temperature for continuously 3 minutes, heat pump OFF but water pump continue ON.
- Heat pump thermo ON temperature
 - 1 Heat pump thermo ON temperature = water inlet during thermo OFF time + [-3°C]
 - 2 When water outlet temperature < heat pump thermo ON temperature, heat pump ON.

Water inlet thermo protection condition

- Heat pump thermo OFF temperature:
 - 1 Water inlet temperature > [57°C/55°C] for continuously 30 seconds, heat pump OFF, water pump continue ON.
- Heat pump thermo ON temperature:
 - 1 Heat pump thermos ON temp = water inlet temperature < [57°C/55°C].

Outdoor ambient temperature	Water inlet temperature
< 5°C	55°C
>= 5°C	57°C

Thermo ON/OFF for Heat Pump in Tank Operation:

When tank temperature achieve heat pump OFF condition, refer below condition:

Condition 1 : When Internal Tank Heater is select and Tank Heater ON

- Heat pump will turn OFF, water pump continue ON and room heater will continue ON if tank temperature below tank heater thermo ON condition. 3 ways valve will only switch to room side after tank temperature reach tank heater thermo OFF condition.

Condition 2 : When Tank Heater select OFF OR when External Tank Heater is select and Tank heater ON

- If tank temperature achieve tank thermo OFF, heat pump turn OFF, water pump turn OFF, room heater OFF and 3 ways valve switch to room side.

When tank temperature achieve heat pump ON condition, water pump ON, heat pump ON and room heater turn OFF.

Heat pump OFF condition at Tank Mode

- Tank temperature > tank water set temperature continuously for 20 seconds after heat pump thermos OFF due to water thermo. (Heat pump turn OFF but water pump continue ON and room heater turn ON to achieve tank set temperature) **OR**
- Tank temperature > tank set temperature + [1°C] for continuously 20 seconds. (Heat pump OFF, water pump OFF, room heater OFF and 3 ways valve switch to room side)

Heat pump ON condition at Tank Mode

- Tank temperature < tank water set temperature + R/C setting (Tank re-heat temp)
(Water pump turn ON OR continue ON, heat pump ON and 3 ways valve switch to tank side or maintain at tank side)
- Room heater control
 - Internal heater only operates to tank side if the Internal Tank Heater is select, Tank heater ON and backup heater is enable.

Room heater turn ON condition:

- Tank temperature < tank set temperature **AND**
- Heat pump thermos OFF **AND**
- 20 minutes from previous heater off **AND**
- Internal tank heater selects USE from control panel.

Room heater turn OFF condition:

- Tank temperature > tank set temperature for continuously 15 seconds **OR**
 - Heat pump thermo ON **OR**
 - Mode change or operation is off by control panel.
-
- Tank Heater control
 - External heater only operate to tank side if tank heater ON & External Heater select.

11.1.10 Heat + Tank Mode Operation

- 1 3 ways valve control:
 - 3 ways valve switch to room side during room heat-up interval and switch to tank side during tank heat-up interval. Both modes will switch alternately. Tank mode is the initial running mode of Heat + Tank mode.
- 2 Heat pump operation control:
 - During room heat-up interval
 - Follow normal heating operation.
Switching to tank side depends to below cases:
Case 1:
[Previous switch from tank interval to room interval due to thermo OFF]
 - Switch to tank heat-up interval when Tank temp < Tank thermostats ON temp (Room heat-up interval ends)
Case 2:
[If heating operation at room side is less than 30 minutes and switch to tank side 3 times consecutively]
 - Maintain at room heat-up interval regardless of the tank temperature. Switch to tank heat-up interval only when (Room Interval Timer is complete **OR** Room heat pump thermo OFF) **AND** Tank temperature < Tank thermo ON temperature.
Case 3:
[Previous switch from tank interval to room interval due to tank interval timer is complete]
 - Maintain at room heat-up interval regardless of the tank temperature. Switch to tank heat-up interval only when (Room Interval Timer is complete **OR** Room heat pump thermo OFF) **AND** tank temperature < Tank thermo ON temperature.
 - During Tank heat-up interval
 - Tank interval is the first mode running when heat + tank mode is select.
 - Switch to room interval only when tank achieve tank thermo OFF **OR** tank heat-up interval timer is complete.
 - Heat pump operates according to normal tank mode operation.
- 3 Room heater control:
 - During heating heat-up interval
 - Follow normal room heater control operation.
- 4 Tank heater control:
 - During heating heat-up interval
 - If External tank heater is select.
 - External heater ON/OFF according to external tank heater operation control.
 - If internal tank heater is select.
 - Internal tank heater will not function under heating heat-up interval.
 - During tank heat-up interval
 - If External tank heater is select.
 - Once heating heat-up interval switched to tank heat-up interval, tank heater is turn OFF and tank heater delay timer will start counting.
 - Tank heater will turn ON after tank heater delay timer is fulfill and tank temperature is lower than tank set temperature.
 - Tank heater delay timer is clear when switching to heating heat-up interval.
 - If internal tank heater is select.
 - Internal tank heater will turn ON after heat pump thermo off to boil tank temperature to tank set temperature.
 - 2 ways valve control is open
 - Indoor water pump control:
 - Indoor water pump always turn ON if room heat pump thermo ON **OR** Tank thermo ON.

11.1.11 Cool + Tank Mode Operation

- 1 3 ways valve control:
 - 3 ways valve switch to room side during room cooling interval and switch to tank side during tank heat-up interval. Both mode will switch alternately. Tank mode is the initial mode of cool + tank mode.

- 2 Heat pump operation control:
 - During room heat-up interval
 - Follow normal cooling operation.
Switching to tank side depends to below case:
Case 1:
[Previous switch from tank interval to room interval due to thermo OFF]
 - Switch to tank heat-up interval when Tank temperature < Tank Thermo ON temperature (Room interval will ends)
Case 2:
[If cooling operation at room side is less than 30 minutes and switch to tank side for 3 times consecutively]
 - Maintain at room cooling interval regardless of the tank temperature. Switch to tank heat-up interval only when (Room Interval Timer is complete **OR** Room heat pump thermo OFF) **AND** Tank temperature < Tank thermo ON temperature.
Case 3:
[Previous switch from tank interval to room interval is due to tank interval timer is complete]
 - Maintain at room cooling interval regardless of the tank temperature. Switch to tank heat-up interval only when (Room Interval Timer is complete **OR** Room heat pump thermo OFF) **AND** tank temperature < Tank thermo ON temperature.

*Tank Thermo ON temperature:

Internal Tank Heater select USE	<Tank set temperature + R/C setting (Tank re-heat temperature)
Others	<Tank water set temperature + R/C setting (Tank re-heat temperature)

- During Tank heat-up interval
 - Tank interval is the first mode running when the cool + tank mode is select.
 - Switch to room interval only when tank achieve tank thermo OFF **OR** tank heat-up interval timer is complete.
 - Heat pump operates according to normal tank mode operation.

- 3 Room heater control:
 - During room cooling interval
 - Room heater is OFF and not operates.

- 4 Tank heater control:
 - During room cooling interval
 - If external tank heater is select.
 - External heater ON/OFF according to external tank heater operation control.
 - If internal tank heater is select and tank heater ON
 - Internal tank heater will not function under room cooling interval.
 - During tank heat-up interval
 - If external tank heater is select
 - Once room cooling interval switch to tank heat-up interval, tank heater will turn OFF and tank heater delay timer will start counting.
 - Tank heater turns ON after tank heater delay timer is fulfill and tank temperature is lower than tank set temperature.
 - Tank heater delay timer is clear when switch to room cooling interval.
 - If internal tank heater is select and tank heater ON.
 - Internal tank heater will turn ON after heat pump thermos off to boil tank temperature to tank set temperature.

- 5 2 ways valve is close.

- 6 Indoor water pump control:
 - Indoor water pump always turn ON if room heat pump thermo ON **OR** Tank thermo ON.

11.1.12 Outdoor Fan Motor Operation

Outdoor fan motor is adjusted according to operation condition. It starts when compressor starts operation and it stops 30 seconds after compressor stops operation.

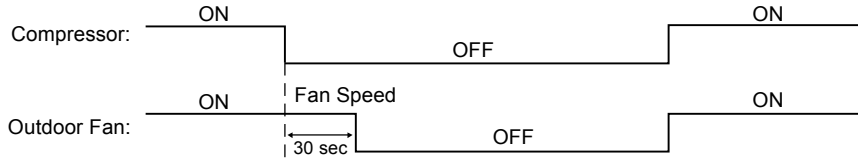

11.2 Water Pump

11.2.1 Water Pump Control

- Once the indoor unit is ON, the water pump will be ON immediately and no error judgment for 70 seconds. However, during this 70 seconds operation, if there is any abnormality cause at outdoor or malfunction, the compressor should be OFF immediately and restart delay after 3 minutes.
- The system will start checking on the water flow level after operation start for 70 seconds. If water flow level is detected low continuously 60 seconds, the water pump and the compressor will be OFF permanently and OFF/ON control panel LED will blink (H62 error occurs).
- When error happens, the power has to be reset to clear the error.
- If there is no error indication, the water pump shall be continuously running.
- The water pump will remain ON when compressor OFF due to thermostat OFF setting is reached.
- Water pump will OFF when room thermo OR tank thermo OR buffer tank thermo OFF.
- Water pump will delay 15 seconds to turn OFF when request to OFF except during anti-freeze deice activate or air purge mode.

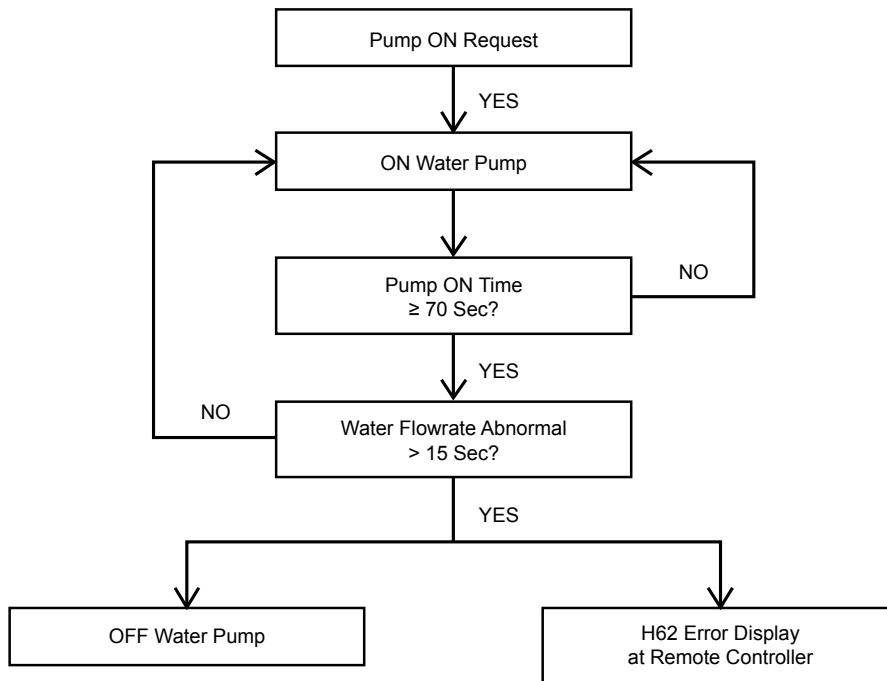

Maximum pump speed setting on remote control

- Standard pump speed is automatically controlled to get the designed water temperature different between water inlet and outlet (ΔT). Instead of setting the standard pump speed, maximum pump speed is manually adjusted by the installer according to water circuit pressure drop.

However, the following sequences do not follow maximum pump duty setting by remote control.

- Pump down mode
- Air purge mode
- Normal deice

1) P-Q graph for different pump HEX duty

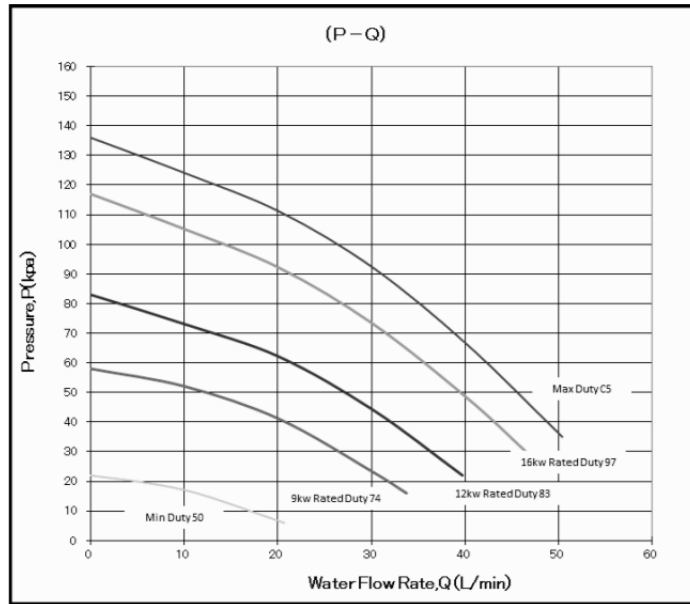

11.2.2 Zone Water Pump Control

Purpose:

- Water pump install at each zone to circulate the water inside each zone during buffer tank connection selected “YES” or 2 zone systems.

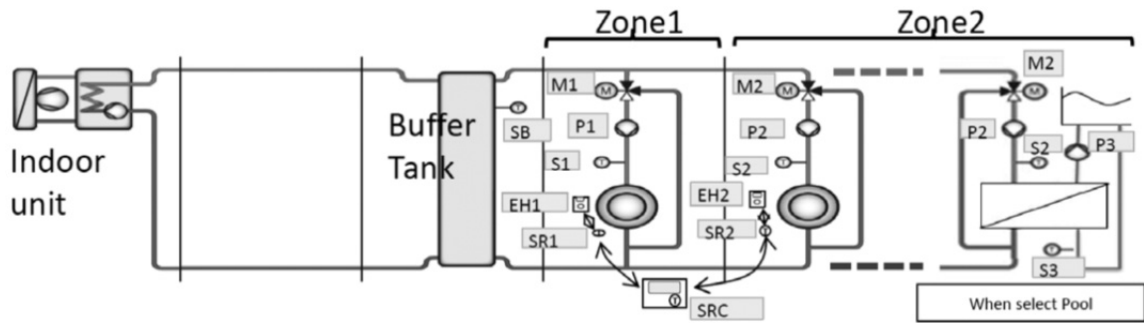

Content:

- AC type water pump install for this zone water pump control. When optional PCB connected, 230V output will drive this zone pump.
- There are three pump can be connected through Optional PCB. (Zone 1 Pump, Zone 2 Pump, & Pool Pump)

* Zone 1 pump [P1] use to circulate zone 1 water circuit & Zone 1 mixing valve [M1] adjust to control the Zone 1 target water temperature.

* Zone 2 pump [P2] use to circulate zone 2 water circuit & Zone 2 mixing valve [M2] adjust to control the Zone 2 target water temperature.

* When Pool Function select as Zone 2 circuit, [P2] use to circulate water to heat exchanger which use to transfer heat to pool water.

* Pool pump [P3] circulates the pool water through the heat exchanger to get warm water.

- Zone 1 and Zone 2 water pump start condition:
 - Zone room request ON
(eg. Zone 1 thermo ON, only zone 1 pump will turn ON)
- Zone 1 and Zone 2 water pump stop condition:
 - Zone room request OFF
- Pool water pump start condition:
 - Pool Zone request ON **AND**
 - Pool function is selected
- Pool water pump stop condition
 - Pool zone: Zone room request OFF **OR**
 - Pool function is cancel

* Zone 1 & Zone 2 water pump need to turn OFF when antifreeze deice pump stop control activate and turn ON back after the antifreeze deice pump stop control end under setting of "NO" buffer tank connection.

Zone Pump Prohibit ON control:

- Start condition:
 - Zone 1 water temperature $\geq 75^{\circ}\text{C}$ continuously for 5 minutes
 - *stop zone water water pump operates if the zone water fulfilled.
- Cancel condition:
 - After 30 minutes from start condition fulfilled.
 - *zone water pump operates according to normal condition.

Zone Pump Control during Anti-Freeze

Zone pump control during Zone Anti-Freeze Control:

- When Zone Anti-Freeze Flag=1, Zone Pump Turn ON.
- When Zone Anti-Freeze Flag=0, Zone Pump Turn OFF.

Zone pump control during Indoor Anti-Freeze Control:

- Zone pump only ON/OFF if the Extension PCB connected and Buffer Tank select "NO" condition

When Indoor Anti-Freeze flag=1, Zone Pump Turn ON

When Indoor Anti-Freeze flag=0, Zone Pump Turn OFF

* Pool Water Pump will not affected by both Indoor anti-freeze control or zone anti-freeze control.

11.2.3 Water Pump Speed Feedback Error

- Basically pump speed feedback is control by micon.
- When pump speed is below low limit or over high limit for a few seconds, micon detect pump error and system is stopped.
- Error detection conditions:
 - Detect abnormal water pump speed for continuous 10 secs.
 - Current pump speed < 700 rpm or
 - Current pump speed > 6000 rpm for 10 seconds.
- Control contents:
 - When error occurs, water pump, heating and heater is stopped for 30 seconds then restart again (Retry control).
 - When micon detect error again, system is stopped and error code [H20] is displayed at control panel.

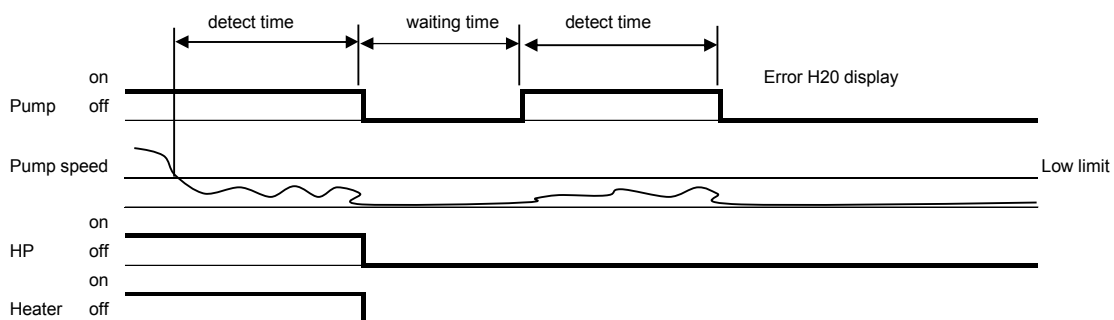

11.3 Indoor Unit Safety

11.3.1 Indoor Unit Safety Control

- 1 When water pump is ON, the system will start checking flow switch status (ON/OFF).
- 2 If the flow switch ON for 10 seconds, the system will check on the water inlet temperature for 10 seconds. If the water inlet temperature not exceeds 80°C, the water pump shall be continuously running with normal mode.
If the water inlet temperature exceeds 80°C for continuously 10 seconds, the water pump will be OFF immediately.
- 3 After water pump OFF for more than 10 minutes, it will be ON back and the indoor unit safety control checking is restarted.

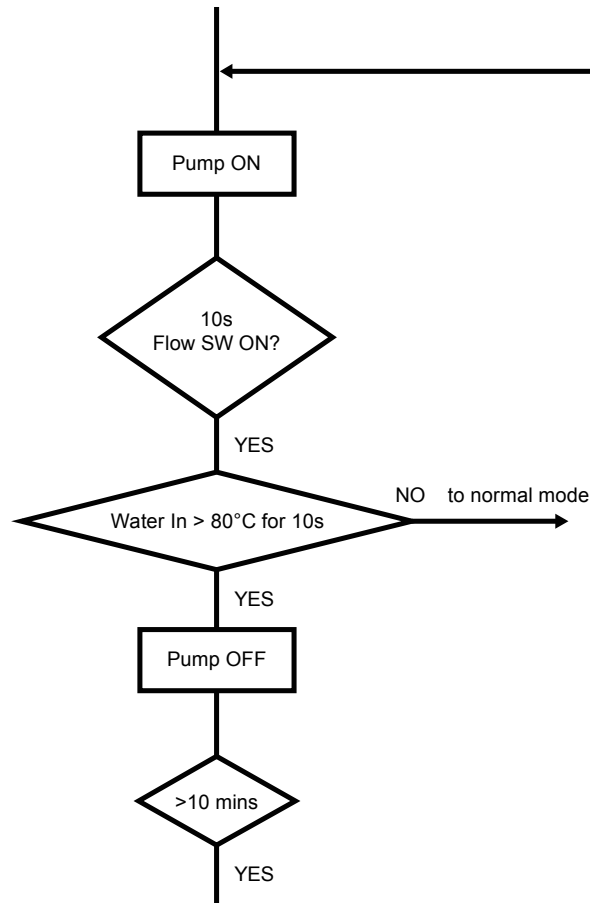

11.4 Auto Restart Control

- 1 When the power supply is cut off during the operation of Air-to-Water Heatpump, the compressor will re-operate after power supply resumes.

11.5 Indication Panel

LED	Operation
Color	Green
Light ON	Operation ON
Light OFF	Operation OFF

Note:

- If Operation LED is blinking, there is an abnormality operation occurs.

11.6 Indoor Back-Up Heater Control

11.6.1 Indoor Electric Heater Control

- 1 Normal Heating Mode
 - Heater On condition:
 - a. Heater switch is ON
 - b. After Heatpump thermo ON for **[30]** mins
 - c. After water pump operate **[9]** mins
 - d. Outdoor air temperature < Outdoor set temperature for heater
 - e. When water outlet temperature < Water set temperature + **[-4°C]**
 - f. **[20]** minutes since previous Backup heater Off
 - * When heatpump cannot operate due to error happens during normal operation, heater will go into force mode automatic
 - * Heater need to operate during deice operation
 - Heater Stop Condition:
 - a. When outdoor set temperature > outdoor set temperature + **[+2°C]** for continuous 15 secs OR
 - b. When water out temp > water set temperature + **[-2°C]** for continuous 15 secs OR
 - c. Heater switch is Off OR
 - d. Heatpump thermo-off or OFF condition
- 2 Force Heater Mode
 - Heater On condition:
 - a. After water pump operate **[9]** mins
 - b. When water outlet temperature < water set temperature + **[-4°C]**
 - c. **[20]** minutes since previous Backup heater Off
 - Heater Stop condition
 - a. Force mode off **OR**
 - b. When water outlet temperature > water set temperature + **[-2°C]** for continuous 15 secs

* Do not operate heater at the following situation

- 1 Water outlet temperature sensor, and water inlet sensor abnormal
- 2 Flow switch abnormal
- 3 Circulation pump stop condition

11.6.2 Room Heater Operation during Deice

Purpose:

- To protect the indoor Heat Exchanger from ice forming and prevent heat exchanger plate breakage.

Control content:

- This Heater protection control will activate only if the backup heater is enable at custom setup by remote controller. Once fulfil the start condition, room heater will turn ON together (base on max heater capacity selection) and stop together if stop condition is fulfilled.
 - * If the heater is request to turn ON OLP feedback will be detected.

Starting conditions:

- 1 During normal deice operation 4~9
- 2 Water outlet temperature < 10°C or
Outdoor air temperature < -10°C or
Water inlet temperature < 27°C

Heater operates when 1 ~2 fulfilled **OR** When 1 and 3 ~ 4 is fulfilled.
However, this control does not relate to Heater ON/OFF button on remote control.

Stop condition:

- When normal deice end or
- Water outlet temperature > 45°C

However, room heater keeps ON if indoor electric heater control activate.

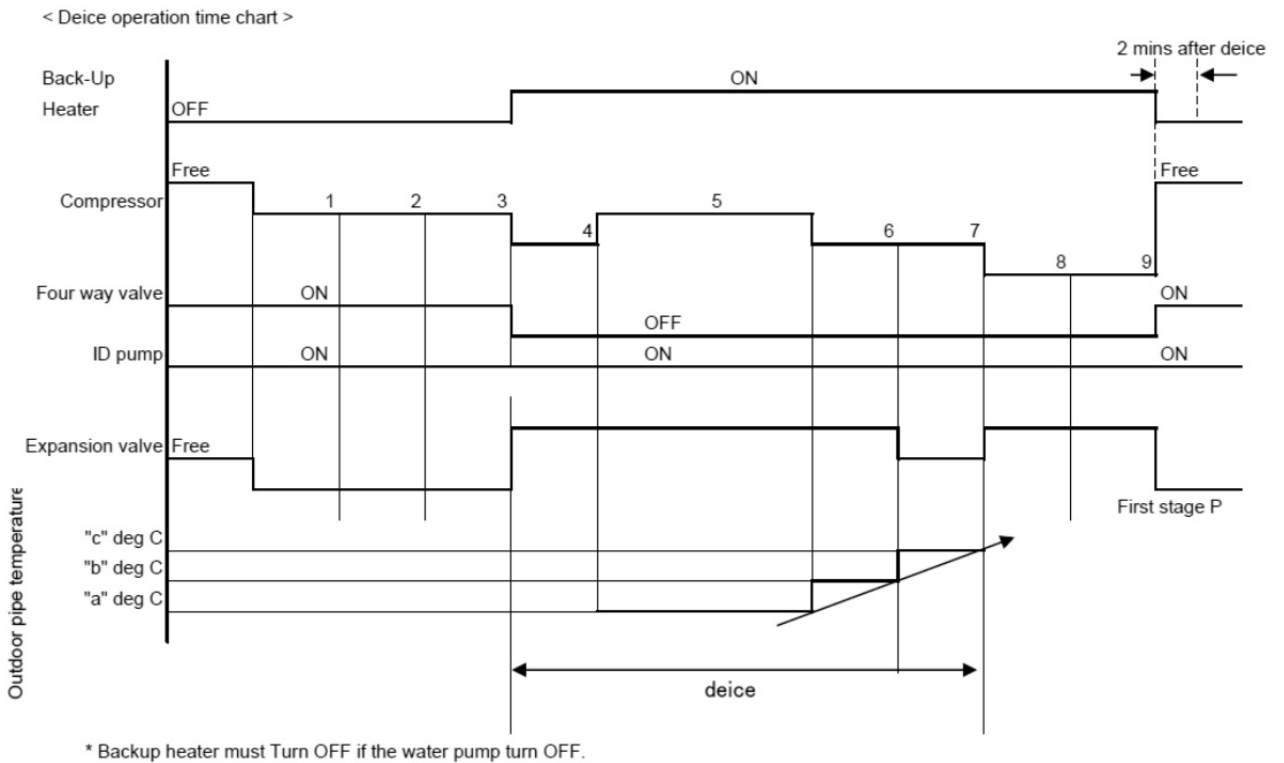

11.7 Tank Heater Control

11.7.1 Tank Heater Remote Control Setting

- Tank heater selection:
 - External: - Booster Heater use to heat up tank when select external
 - Internal: - Backup Heater use to heat up tank when select internal
 - * When select External Tank Heater, Heater Delay ON Timer need to set. (range 20 min ~ 3 hrs)
- Tank Heater ON/OFF selection by user.

The remote control Tank set Temperature range will change according to the External and Internal Tank Heater use.

Tank Heater Selection	Range
External	40 ~ 75°C
Internal	40 ~ 65°C

11.7.2 External Heater Control at Tank Side

Heating operation condition:

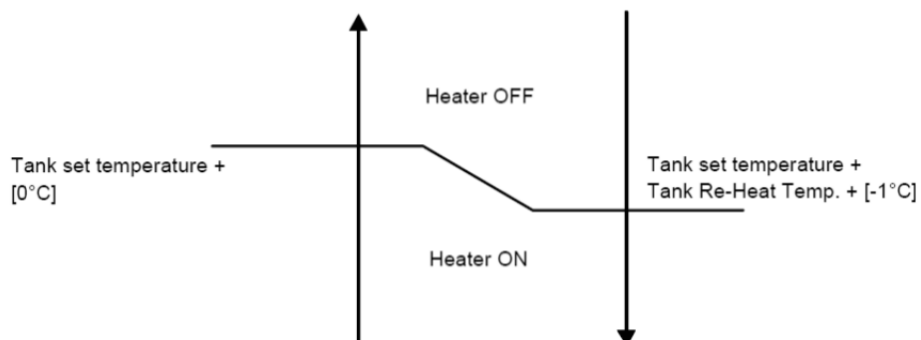

- Tank heater Turn On condition:
 - External Heater select for Tank heater by remote controller.
 - Tank Heater select ON by user.
 - Tank mode operation ON (Tank mode, Heat + Tank, or Cool + Tank)
 - After TANK HEATER DELAY TIMER fulfil during heat pump startup time in tank mode, or during switching from heating heat-up interval to tank heat-up interval in heat + tank mode
 - Tank temperature < tank set temperature + [Remote controller Set Tank Re-heat Temp] + [-1°C]
 - 20 minutes since previous heater off.

* TANK HEATER DELAY TIMER is clear when tank heat-up interval end.
- Tank heater Turn Off condition:-
 - Tank temperature > tank set temperature + [0°C] for continuous 15 seconds.
 - When BOOSTER HEATER DELAY TIMER start count after switch from heating heat-up interval to tank heat-up interval.
 - Tank Heater select OFF by user
 - Tank Mode Operation OFF.

11.7.3 Internal Heater Control at Tank Mode

- Internal heater turn ON condition:
 - 1 Internal Heater select for Tank heater by remote controller
 - 2 Tank Heater select ON by user.
 - 3 Backup Heater Enable
 - 4 Tank Temperature < Tank Set Temperature
 - 5 Heat Pump Thermo OFF
 - 6 20 minutes from previous heater off.
- Room heater turn OFF condition:
 - 1 Tank Temperature > Tank Set Temperature + [0°C] for continuous 15 seconds. **OR**
 - 2 Heat Pump Thermo ON **OR**
 - 3 Mode Change or Operation OFF by remote controller **OR**

* Backup Heater Turn ON/OFF all together according to the selected heater capacity.

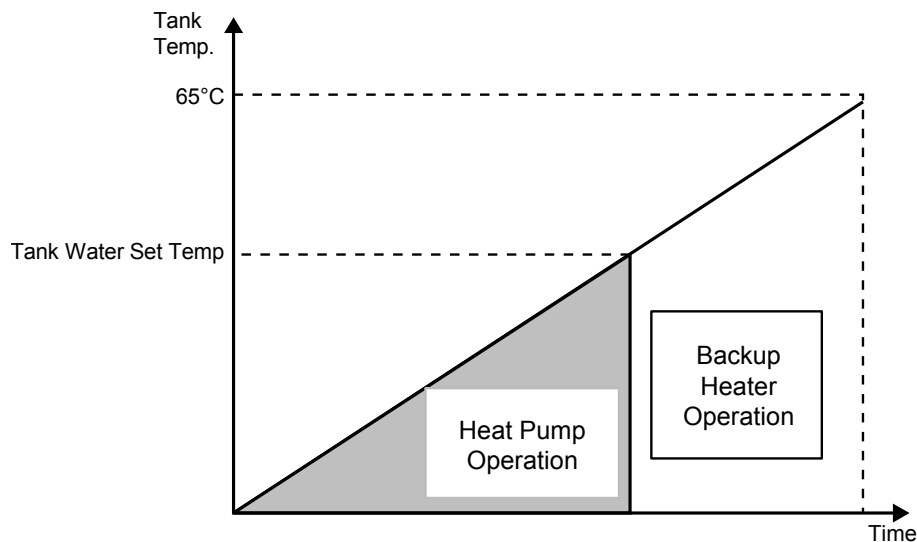

11.8 Base Pan Heater Control (Optional)

- To enable the base pan heater function, control panel initial setting has to be manually adjusted by activating Base Pan Heater menu.
- There are 2 optional start condition can be selected, Type A or Type B.

- Control details:

- 1 Type A: (Default Auto Mode)

Start conditions:

- When outdoor air temperature $\leq 3^{\circ}\text{C}$ during heating and deice operation is ON.

Control contents:

- Base pan heater is ON during deice operation and continues ON for 10 minutes after deice operation ends.

Cancel condition:

- When outdoor temperature $> 6^{\circ}\text{C}$ after deice end or
- When operation is not at heating mode or
- Base pan heater ON timer count is completed.

- 2 Type B: (ON Mode)

Start conditions:

- When outdoor air temperature is $\leq 5^{\circ}\text{C}$ and operates in heating mode, base pan heater is ON.

Cancel conditions:

- When outdoor air temperature is $> 7^{\circ}\text{C}$ or
- When operation is not at heating mode.

11.9 Heater Turn ON/OFF priority Control

Purpose:

- To allow only one heater between room and tank heater to turn ON at the same time due to both heater power supplies is sharing the same ELCB. Prohibit two heater sources to turn ON at the same time to avoid overcurrent.

Start condition:

- Tank heater function select YES by remote controller

Control contents:

- When there is only one heater source (Room Heater or Tank Heater) request to turn ON, operate same as normal room heater and tank heater operation.
- When both backup heater and booster heater request to turn ON at same time, will turn ON only ONE heater source. Under normal condition, tank heater has priority to turn ON except below condition.
 - Backup Heater Priority to Turn ON when
 - Request Backup heater turn ON at Hex Protection control during deice.
 - Request Backup Heater turn ON at Hex Protection Control during low water temperature.
 - Request Backup Heater turn ON at Anti-frost control.
 - Heat pump error and Force Mode operate.
- When switching from booster heater to backup heater **OR** backup heater to booster heater, need to delay 5 seconds in between Turn OFF one heater source and Turn ON another heater source.

11.10 Force Heater Mode

Purpose of Force Heater Mode:

- As a backup heat source when heat pump error. Force heater Mode control backup heater to heat up the room circuit, and turn ON back up heater or booster heater to boil up tank water base on the tank heater selection (internal or external).

Force Heater Control start condition:

- Force heater request ON by user **OR** auto turn ON by remote controller during error **AND** (Force Heater mode can be operate regardless of mode selection, remocn will send the latest mode selection force bit to indoor. Indoor will judge to turn ON heater to room side if it is heat mode selected, and turn ON heater to heat up tank water base on tank heater selection)
- During Error Happen (exclude the error list below)

Error List not allow Force Heater operation

H12	Capacity Mismatch	H76	Indoor-Remote Controller Communication Error
H20	Abnormal Water Pump	H95	Abnormal Voltage Connection
H62	Abnormal Water Flow	F37	Abnormal Water Inlet sensor
H70	Abnormal Back-up Heater OLP	H45	Abnormal Water Outlet sensor
H74	PCB Communication Error		
[When tank mode operate with external heater selected & tank heater select ON]			
H72	Abnormal tank sensor	H91	Abnormal tank heater OLP

Force Heater Control Stop Condition:

- Force Heater request OFF **OR**
- Operation OFF request **OR**
- Power reset **OR**
- Error of above list happen during force heater operation.

Control contents:

- After fulfill start condition, indoor will operate the force heater operation according to below mode condition
Heat mode Only: Turn ON backup heater to achieve room heat pump target water temperature.
Heat + Tank mode: Turn ON backup heater to heat up room **OR** Turn ON Heater to Boil up tank water.
Cool mode Only: Water pump and backup heater will OFF in force heater mode.
Cool + Tank mode: Operate pump and internal Heater **OR** External heater to Boil up tank water.
Tank mode Only: Operate pump and internal Heater **OR** External heater to Boil up tank water.
* For heat mode condition, backup heater will only turn ON if the backup heater is enable regardless of Room Heater Selection.
* For tank mode condition, If internal heater selected backup heater will turn ON to boil up tank water.
If external heater selected , booster heater will turn ON to boil up tank water regardless of tank heater selection.

Room Side: (Heat Mode):

- When force heater mode start condition fulfilled, turn ON water pump and turn ON backup heater follow below control.
- Operate the 3 ways valve at room side only and turn ON 2 ways valve as heat mode operation.
- Turn ON the zone pump and mixing valve if system select 2 zone system or Buffer tank connect YES, control according to normal zone pump and mixing valve control.
- When Force heater mode stop condition fulfilled, turn OFF heater as below condition and turn OFF water pump after pump delay time.

Backup Heater On Condition:

- When Force Heater Control start condition fulfill **AND**
- After water pump operate 2 minutes **AND**
- When water outlet temperature < water set temperature + [-4°C] **AND**
- 20 minutes since previous Backup heater Off **AND**
- Backup Heater Enable

Backup Heater Stop condition:

- Force mode off **OR**
- Operation off **OR**
- When water outlet temperature > water set temperature + [-2°C] for continuous 15 secs **OR**
* ON/OFF follow normal heater sequence.

Tank side (Tank mode):

- When tank mode select and force heater bit received, turn ON backup heater (INTERNAL) or Booster Heater (External) depend on the tank heater selection.
- If tank heater selection is INTERNAL, follow normal thermo judgement to switch 3 ways valve to tank side and room side.
- If tank heater selection is EXTERNAL, only turn ON booster heater according to tank thermo.

Tank Heater selection is INTERNAL:

Backup Heater ON Condition:

- After water pump operate 2 mins **AND**
- When tank temperature < Tank set temperature - [Remocon Set Tank Re-heat Temp] **AND**
- 20 minutes since previous Backup heater OFF **AND**
- Backup Heater Enable

Backup Heater OFF condition:

- Force mode OFF **OR**
- When tank temperature > Tank set temperature for continuous 15 secs **OR**
- Tank Operation OFF

Tank Heater selection is EXTERNAL:

Booster Heater ON condition:

- Force Heater mode ON **AND**
- Tank temperature < tank set temperature + [Remocon Set Tank Re-heat Temp] - 1°C, **AND**
- 20 minutes since previous heater off.

Booster Heater OFF condition:

- Tank temperature > tank set temperature for continuous 15 secs.
- Force mode OFF
- Tank Mode Operation OFF
(During tank interval or tank mode condition, water pump and 3 ways valve will OFF)

11.11 Powerful Operation

Powerful mode is use to increase the capacity of heat pump to achieve higher target temperature. Powerful mode is applicable when heat mode is operating.

Remote control setting:

On quick menu of remote control, there is 4 options of powerful mode can be select.

- OFF : Cancel powerful mode
- 30 minutes : Set powerful for 30 minutes
- 60 minutes : Set powerful for 60 minutes
- 90 minutes : Set powerful for 90 minutes

Control contents:

During the time set by remote control, powerful will activate according to 2 shift up controls. However, this function is applicable only for heating. Remote control will transmit the signal to indoor unit once this function is select then transmit OFF signal to indoor when the timer is complete. Indoor will transmit signal to outdoor for frequency control.

Indoor setting temperature shift

- If system is standard system (Optional PCB is not connected)
 - Target water temperature will shift up to Wlo or Whi whichever higher.
 - If system is extension system (Optional PCB is connected)
 - Target water Zone 1 and Zone 2 temperature will shift up to Wlo or Whi whichever higher.
- * If "Direct Type" temperature control is select, this powerful shift up setting is not effective.
- **Start condition**
 - Powerful function is select by remote control.
 - **End Condition**
 - OFF/ON button is pressed.
 - Powerful function is OFF by remote control.

11.12 Quiet Operation

Quiet mode is use to reduce the noise of outdoor unit by reducing the frequency or fan speed.

Quiet level

There are 3 level (Level 1, Level 2, Level 3) to set by quick menu function on remote control.

Control content

Once the quiet function is select, the remote control will transmit the signal to indoor and outdoor unit.

Start condition

- Quiet mode is set on remote control.
- Quiet mode is request ON by weekly timer.

Stop condition

If any of below condition is achieve.

- OFF/ON button is pressed.
- Quiet mode is OFF by remote control.
- Quiet mode is request OFF by weekly timer.

11.13 Sterilization Mode

- Purpose:
 - To sterilize water tank by setting the required boiling temperature.
- Remote control setting
 - Days for sterilization function to start can be select.
 - Time of selected day to start sterilization function.
 - Boiling temperature (External heater is 55°C ~ 75°C, Internal heater is 55°C ~ 65°C)
 - Maximum operation time is 5 minutes to 1 hour.
- Start condition
 - Tank connection set to "YES" by remote control
 - Sterilization function selects "YES".
 - Sterilization signal received from remote controller by timer.
 - Tank mode request ON.
- Stop condition
 - When boiling timer is completed. Boiling timer (Remote control set maximum operation time) start counting once tank achieve boiling set temperature **OR**
 - After 8 hours of operation since sterilization start.
 - Tank mode request OFF.
- Control content:
 - During sterilization function activation time, target tank set temperature will internally change to boiling set temperature.
 - During sterilization activates, heat pump and heater (external or internal) will operate as normal tank mode to achieve the boiling set temperature.
 - Sterilization operation will end when stop condition is fulfill.
 - After sterilization is complete, tank set temperature will resume to normal operation.

* Tank temperature may not achieve boiling set temperature if tank heater is select OFF **OR** external compressor switch.

11.14 Outdoor Ambient Thermo OFF Control

- Purpose:
 - Stop provides heating to room side during high outdoor ambient condition.

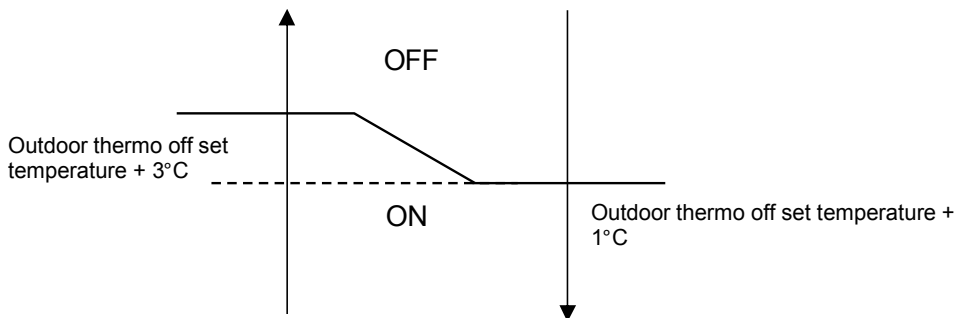

- Control content:
 - Heating outdoor ambient thermos OFF control only applicable when heat pump operate in heat mode. (This control will not activate when running in tank side)
 - Heat pump and water pump will turn OFF when outdoor ambient is higher than outdoor thermo OFF set temperature.
 - Heat pump thermos ON when outdoor ambient < outdoor thermos OFF set temperature + 1°C.

11.15 Alternative Outdoor Ambient Sensor Control

Purpose of the Alternative Outdoor Ambient Sensor:

- It is some possibility that the air to water heat pump unit will install at a location where the original ambient sensor is expose to direct sunlight. Therefore, another optional ambient sensor can be connect to indoor PCB and locate at new and better reading location to improve the heat pump performance.

Control Detail:

- Remocon can select either the extra outdoor ambient sensor is connected or not. (YES/NO)
- The alternative outdoor ambient sensor will connect to indoor unit main PCB terminal.
 - when alternative sensor select NO
 - Original Outdoor temperature sensor will use for Indoor & Outdoor heat pump operation reference sensor.
 - Data communication direction : OUTDOOR send outdoor temperature reading to INDOOR.
 - Error judge : OUTDOOR will judge the original outdoor sensor error (F36 display if error detect). No judge error on alternative outdoor sensor
 - when alternative sensor select YES
 - Alternative Outdoor temperature sensor will use for Indoor & Outdoor heat pump operation reference sensor.
 - Data communication direction : INDOOR send outdoor temperature reading to OUTDOOR.
 - Error judge : INDOOR will judge the Extra outdoor sensor error only after operation ON request received from remocon. (F36 display if error detect). No judge error on original outdoor sensor.

11.16 Force DHW mode

Purpose:

When user want to use hot water now, user can press this force DWH mode under the quick menu to operate tank only mode to boil up the tank temperature.

Remocon setting:

Force DHW function can be activate under quick menu.

Control Content:

- when press the Force DHW function during operation OFF condition:
 - When receive this Force DHW bit from remocon, indoor will run tank only mode regardless of the mode selection.
 - After tank temperature achieve tank thermo off temperature, turn OFF force DHW bit and return to operation OFF with previous mode selection.

- When press the Force DHW function during operation ON condition:
 - When receive this Force DHW bit from remocon, indoor will memories the running mode and run tank only mode regardless of the mode selection.
 - After tank temperature achieve tank thermo off temperature, turn OFF force DHW bit and return to previous memories running mode.
- * when operation OFF or mode change request from remocon during force DHW mode operation, End force DHW mode and follow the new request operation.
- * Once receive force DHW mode from remocon, indoor direct start tank mode and consider tank thermo ON. Thermo OFF only when achieve tank thermo OFF depend on the Tank System Setting.

11.17 SMART DHW mode

Panasonic All In One model provide the option to choose STANDARD DHW Mode or SMART DHW Mode for Tank Heat Up according to requirement. SMART DHW mode comparatively consume lower tank heat up power but longer re-heat time than STANDARD DHW Mode.

SMART DHW control

- During SMART DHW start time 20:00 (Default Setting) to SMART DHW stop time 05:00 (Default setting) Heat pump re-heat the tank water only when tank temperature drop below 20°C (Default setting)
- Time between 05:00 to 20:00
Heat pump reheat the tank water when tank temperature as below condition

Condition 1: Tank Heater ON

Reheat when tank temperature below tank set temperature + R/C (Tank re-heat Temperature) - 3°C

Condition 2: Tank Heater OFF

Reheat when tank temperature below Tank set temperature or 51°C (Whichever lower) + R/C (Tank re-heat Temperature) -3°C

* SMART DHW start time, stop time and SMART ON Temperature can change in CUSTOM menu.

11.18 Anti Freeze Control

- Anti freeze protection control menu can be set YES or NO by control panel.
- In heatpump system, there are 3 types of anti freeze control:
 1. Expansion tank anti-freeze control
 - Expansion tank anti freeze heater ON condition:
 - Outdoor ambient temp. < 3°C
 - Expansion tank anti freeze heater OFF condition:
 - Outdoor ambient temp. > 4°C
 2. Water pump circulation anti freeze control
 - Water pump turns ON when **ALL** below conditions are fulfilled:
 - Heatpump OFF (stand by) OR error occurs.
 - Water flowing flag is ON.
 - Water flow switch is not abnormal.
 - Outdoor ambient temp. < 3°C OR outdoor ambient temp. sensor is abnormal.
 - Water inlet/outlet temp. < 6°C.
 - After 5 minutes from previous water pump OFF.
 - Water pump turn OFF when **ANY** of below conditions is fulfilled:
 - Outdoor ambient temperature $\geq 4^{\circ}\text{C}$.
 - During $-5^{\circ}\text{C} < \text{outdoor ambient temp.} < 4^{\circ}\text{C}$
 - After water pump ON for 4 minutes, and water inlet temp. $\geq 8^{\circ}\text{C}$.
 - Else, shift to back up heater anti freeze control.
 - During outdoor ambient temp. < -5°C
 - After water pump ON for 4 minutes, and water inlet/outlet $\geq 20^{\circ}\text{C}$.
 - Else, shift to back up heater anti freeze control.
 - However, if flow switch is abnormal (H62), then water pump circulation anti freeze control will not activate.

3. Back up heater anti freeze control:
 - Back up heater turn ON when **ALL** below conditions is fulfilled:
 - Water inlet/outlet temp. < 6°C.
 - Water pump circulation anti freeze control activated and water pump ON for 4 minutes.
 - Back up heater turns OFF when ANY of below conditions is fulfilled:
 - Water inlet/outlet temp. > 28°C.
 - Water pump circulation anti freeze control deactivated/water pump OFF.
 - However, if back up heater is abnormal (H70) then back up heater anti freeze control will not activate.

11.18.1 Zone Anti-Freeze Control

- If buffer tank selection is “NO” and Anti- Freeze function select “NO” from remote control, this control cannot activate.

Start condition:

- After [5] min from previous Zone pump off. **AND**
- Outdoor air temp < [3] °C **OR** Outdoor sensor is abnormal. **AND**
- Zone water temperature < [6]°C **OR** Zone Sensor Short or Open

Cancel condition:

- After water Zone pump ON [4] min **AND**
 - Outdoor air temp ≥ [4]°C **OR**
 - During -5 °C ≤ Outdoor air temp < [4] °C **OR**
Zone water temperature sensor > [8] °C
 - During Outdoor air temp < [-5] °C
Zone water temperature sensor > [20] °C
- *However, Zone water temperature sensor is Open or Short, Condition C and D is ignored.

11.19 Solar Operation (Optional)

11.19.1 Solar Operation:

Solar function:

- This function allow user to control the solar pump to operate depend on the solar sensor reading compare to the tank installed. Solar pump will circulate the hot water energy store at solar panel to heat up the DHW Tank or Buffer Tank.

Solar Connection Diagram:

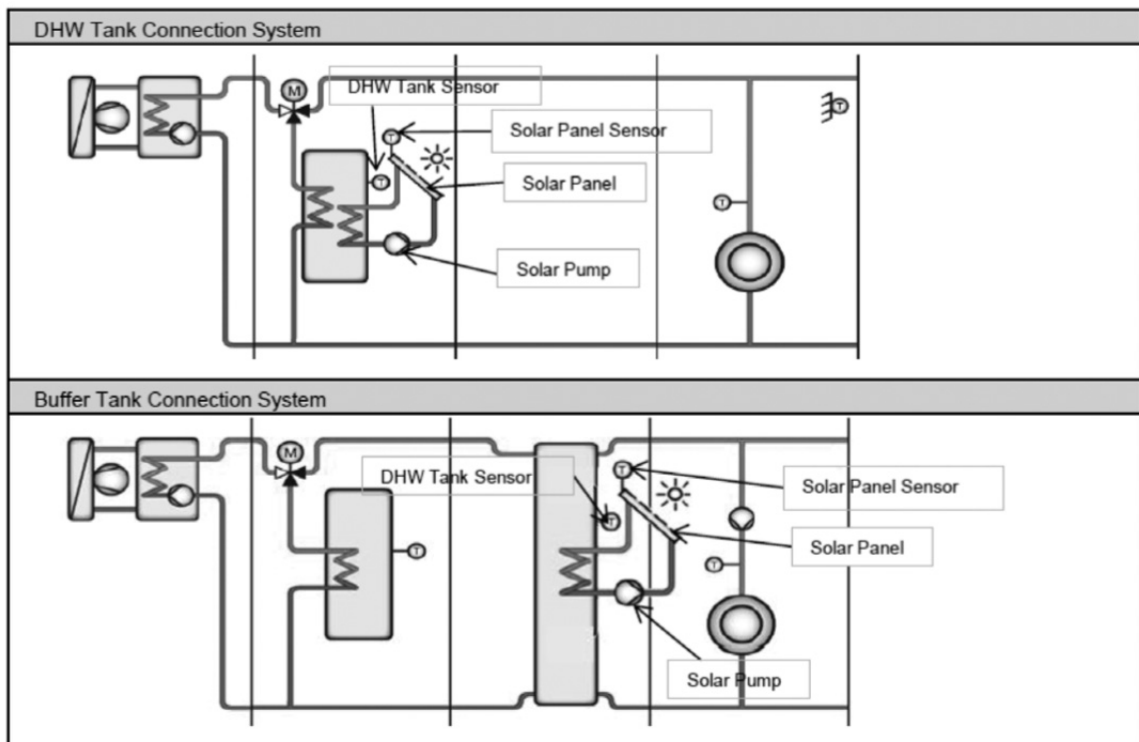

- Solar function can only enable when the Optional PCB is connected.
- Few part as below need to install to control the solar operation:
 - Solar Panel
 - Solar Pump
 - Solar Panel Sensor
 - Tank Sensor (Buffer tank sensor OR DHW Tank sensor depend on the connection direction)
 - * During Solar Connection to the system, installer need to alert on the high water temperature may flow to the zone circuit or DHW piping circuit. Therefore pipe which withstand higher water temperature need to be installed.
- Solar remote control setting
 - 1 Solar Setting can only be set when the optional PCB connection is select "YES"
 - 2 By remote controller, Setting as below list can be set for solar function operation (Installer Menu)
 - Solar Function ("YES" or "NO")
 - Tank Connection Direction ("DHW TANK" or "BUFFER TANK")
 - Delta T turns ON: Difference temperature setting between solar panel sensor and Tank to turn on solar pump. (Range :5 ~ 15°C)
 - Delta T turns OFF: Difference temperature setting between solar panel thermistor and Tank to turn off solar pump. (Range :2 ~ 10°C)
 - Outdoor temp for Anti-Freeze : Outdoor temp to start Anti-Freeze control for solar circuit. (Range : -20 ~ 10°C)
 - Tank Temperature HI Limit Set (Range : 70 ~ 90°C)

11.19.2 Solar Operation Control

- Solar function can only be activate if the solar function selection "YES" from remote control. To achieve hot water from solar panel, indoor need to control the solar pump and circulate hot water from solar panel.

Under normal case:

- Solar pump start condition:
 - Solar panel temperature > Delta T turn on setting temp (R/C) + Tank temperature (depend on selection, DHW or Buffer) **AND**
 - Tank temperature (DHW or Buffer) < Solar HI Limit Temp (R/C) **AND**
 - Operation ON with heat mode (apply to solar connect to "Buffer Tank" case)
 - * Condition c) ignore if the solar system is connect to DHW tank (control active under operation OFF time for Tank connection case)
- Solar pump stop condition:
 - Solar panel temperature < Delta T turn OFF setting temp (R/C) + Tank temperature (depend on selection, DHW or Buffer) **OR**
 - Tank hot water temp \geq Solar HI Limit Temp (R/C) + [2]°C

Under solar Anti-freeze protection control:

- Solar pump start condition:
 - Outdoor temp < Outdoor temp setting for Anti-Freeze (R/C)
- Solar pump stop condition:
 - Outdoor temp > Outdoor temp setting for Anti-Freeze + [2]°C

**However, During Cool mode this function cannot activate if Tank selection is "Buffer Tank".

**Solar pump can operate even if Heat pump is under error stop.

- Solar operation during error:
 - During Tank sensor (DHW or Buffer depend on selection) abnormal, Solar operation will not able to function.
 - During Solar Panel sensor detect OPEN (not include SHORT), Solar operation will not able to function too.

11.20 Boiler Bivalent Control

- Boiler is an additional or alternative heat source to heat up the room when necessary.
- Purpose of this control is to turn ON and turn OFF the Boiler output signal when boiler heating capacity needed in the system.
- Boiler is possible to connect to DHW Tank and Buffer Tank depends on the installer.
- Boiler operation parameter need to be set on Boiler itself, indoor do not control the boiler operation direction and operation.

- There are Alternative mode, Parallel mode, & Advance Parallel mode available to select by installer to fit to the total system.

Bivalent control selection by remote controller

Remote control setting value:

1 Outdoor Ambient Set = (Range: -15°C ~ 15°C)

- **Alternative Mode**

- Only one heat source operates at one time, either heat pump or boiler depends on condition.

Control detail:

During Operation ON at Heat mode or Tank mode or Heat + Tank Mode

- Boiler signal turn ON and heat pump and water pump turn OFF when:
 - Outdoor ambient < Outdoor Ambient Set **AND**
 - Boiler prohibit flag = 0

** However indoor water pump can operate when Anti-freeze control condition fulfilled.

- Boiler signal turn OFF and heat pump and water pump turn ON when:
 - Outdoor ambient > Outdoor Ambient Set + [2°C] **OR**
 - Boiler prohibit flag = 1

- **Parallel Mode**

- Parallel mode allows heat pump and boiler ON at the same time. Boiler operates as an additional heating capacity when low heat pump capacity at low ambient condition.

Control detail:

During operation ON at Heat mode or Tank mode or Heat + Tank mode

- Boiler signal turns ON when:
 - Outdoor ambient < Outdoor Ambient Set **AND**
 - Boiler prohibit flag = 0
- Boiler signal turns OFF when:
 - Outdoor ambient > Outdoor Ambient Set + [2°C] **OR**
 - Boiler prohibit flag = 1

- **Advance Parallel Mode**

- Advance parallel mode allow heat pump to operate and turn ON boiler only when ambient and temperature condition is fulfilled.

Remote control setting value:

- 1 Outdoor Ambient Set = (Range : -15°C ~ 15°C)
- 2 Selection of boiler connection direction. (Heat only, DHW only, Heat & DHW)
- 3 Setting data under Heat Direction
 - Start Temperature | START_TEMP |
 - Start Delay Timer | START_TIMER |
 - Stop Temperature | STOP_TEMP |
 - Stop Delay Timer | STOP_TIMER |
- 4 Setting data under DHW Direction
 - Delay Timer | DELAY_TIMER |

Control detail:

During operation ON at Heat Mode

- Boiler signal turns ON when
 - Outdoor ambient < Outdoor Ambient Set **AND**
 - Buffer tank temperature < Target Buffer Tank Temperature + [START_TEMP] for [START_TIMER] **AND**
 - Heat pump operate at room side **AND**
 - Connection of Boiler to Heating Select "YES" From installer menu **AND**
 - Buffer Tank connection select "YES" **AND**
 - Boiler prohibit flag = 0

- Boiler signal turns OFF when
 - Outdoor ambient > Outdoor Ambient Set + [-2°C] **OR**
 - Buffer Tank temperature > Target Buffer Tank temperature + [STOP_TEMP] for [STOP_TIMER] **OR**
 - Heat pump not at room side. **OR**
 - Boiler prohibit flag = 1

During operation ON at Tank Mode

- Boiler signal turns ON when
 - Outdoor ambient < Outdoor Ambient Set **AND**
 - Heat pump operate at tank side for continuous | DELAY_TIMER | **AND**
 - Connection of Boiler to DWH Tank select "YES" from installer menu. **AND**
 - Boiler prohibit flag = 0
- Boiler signal turns OFF when
 - Outdoor ambient > Outdoor Ambient Set + [2°C] **OR**
 - Heat pump not operates at tank side. **OR**
 - Boiler prohibit flag = 1

Boiler prohibit flag control

Purpose:

- For product safety. Boiler signal is OFF when water temperature is too high.

Start condition:

- Water outlet ≥ 85°C continues for 5 minutes.
- Water inlet ≥ 85°C continues for 5 minutes.
- Zone1 water temp ≥ 75°C continues for 5 minutes.
- Zone2 water temp ≥ 75°C continues for 5 minutes.

Contents:

- After start condition fulfilled, set boiler prohibit flag = 1

Cancel condition:

- After 30 minutes from start condition fulfilled.

Contents:

- Set boiler prohibit flag = 0

11.21 External Room Thermostat Control (Optional)

Purpose:

- 1 Better room temperature control to fulfill different temperature request by external room thermostat.
- Recommended external room thermostat:

Maker	Characteristic
Siemen (REV200)	Touch panel
Siemen (RAA20)	Analog

Connection of external room thermostat:

Wire Connection and thermo characteristic of Siemen REV200:

Setting	L/L1 (H)	Heat Thermo	L/L2 (C)	Cool Thermo
Set Temp < Actual Temp	Open Circuit	OFF	Short Circuit	ON
Set Temp > Actual Temp	Short Circuit	ON	Open Circuit	OFF

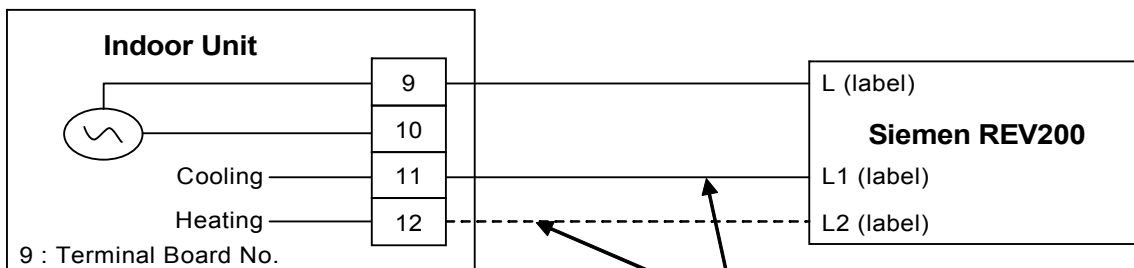

Connect only heating line for heating only model. And connect both heating and cooling line for heat + cool model.

Wire Connection and thermo characteristic of Siemen RAA20:

Setting	L/Y1 (H)	Heat Thermo	L/Y2 (C)	Cool Thermo
Set Temp < Actual Temp	Open Circuit	OFF	Short Circuit	ON
Set Temp > Actual Temp	Short Circuit	ON	Open Circuit	OFF

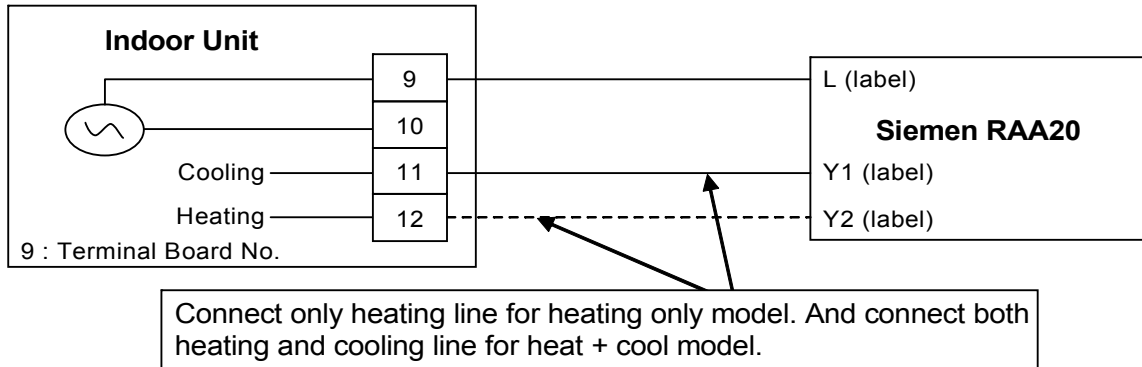

Control Content:

- External room thermostat control activate only when remote thermostat connection select YES by Indoor control panel.
- When indoor running heat mode, refer thermo On/Off from heating line feedback. And when indoor running cool mode, refer thermo On/Off from cooling line feedback.
- Heat pump Off immediately when receive thermo off feedback.

11.22 Three Ways Valve Control

Purpose:

- 3 ways valve is used to change flow direction of hot water from heat pump between heating side and tank side.

Control contents:

- 1 3 ways valve switch Off:
 - o During 3 ways valve switch Off time, the hot water will provide heat capacity to heating side.
- 2 3 ways valve switch On:
 - o During 3 ways valve switch On time, the hot water will provide heat capacity to tank side.
- 3 Stop condition:
 - o During stop mode, 3 ways valve will be in switch off position.

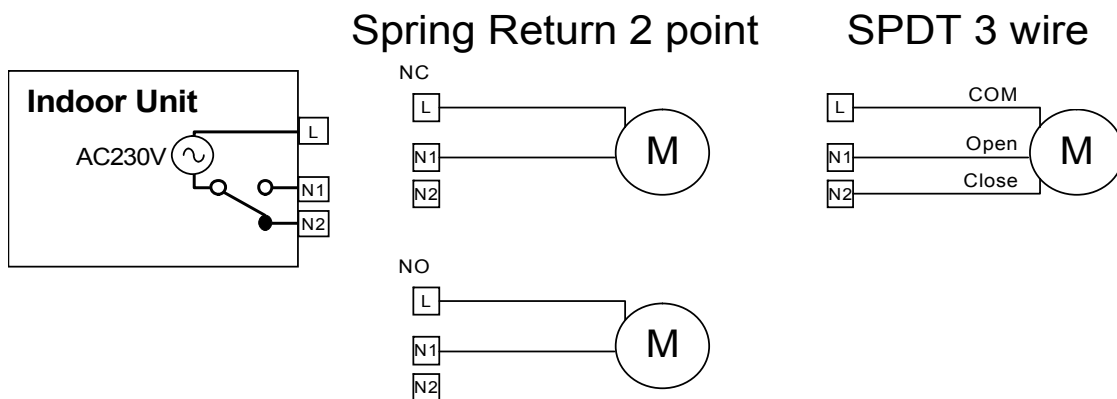

* During pump down and force mode, fix 3 ways valve in close condition.

* Recommended Parts : SFA 21/18 (Siemens)

11.23 Two Ways Valve Control

Functionality of 2 ways valve:

- Use to allow hot water to floor heating panel or block cold water to floor heating panel.

Control contents:

- 1 When indoor running in heat mode, OPEN the 2 ways valve.
- 2 When indoor running in cool mode, CLOSE the 2 ways valve.
- 3 Stop condition:
 - a. During stop mode, fix 2 ways valve in close condition.

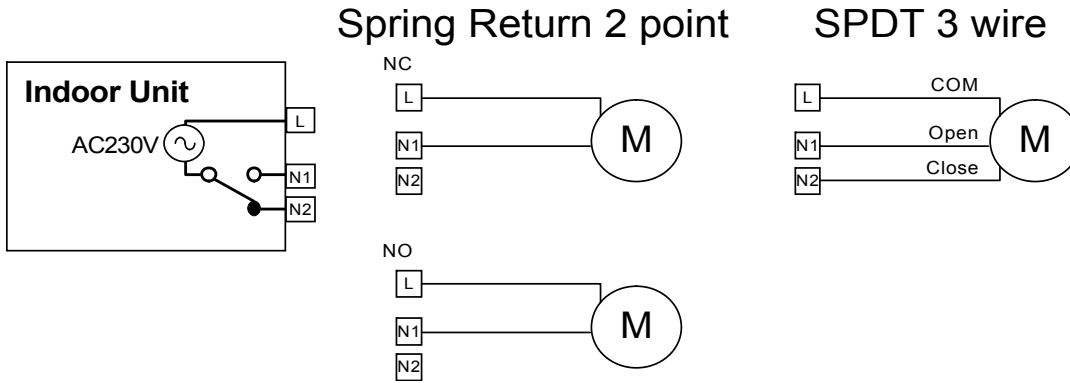

- * During pump down mode, fix 2 ways valve in close condition.
- * During force mode, open 2 ways valve.

* Recommended Parts : SFA 21/18 (Siemens)

11.24 External OFF/ON Control

- Communication circuit between indoor unit and external controller is as per below.

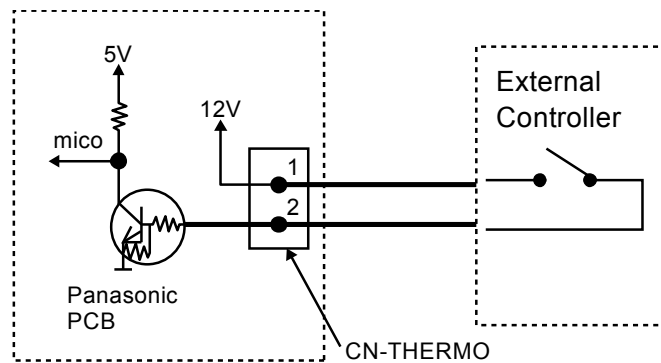

- Maximum length of communication cable is 50 meter.
- Control content:

External Control Switch	Control Panel OFF/ON	Control Panel Power LED	System Status
ON	ON	ON	ON
ON	OFF	OFF	OFF
OFF	ON	ON	OFF
OFF	OFF	OFF	OFF

Remocon Screen Display and Control Detail:

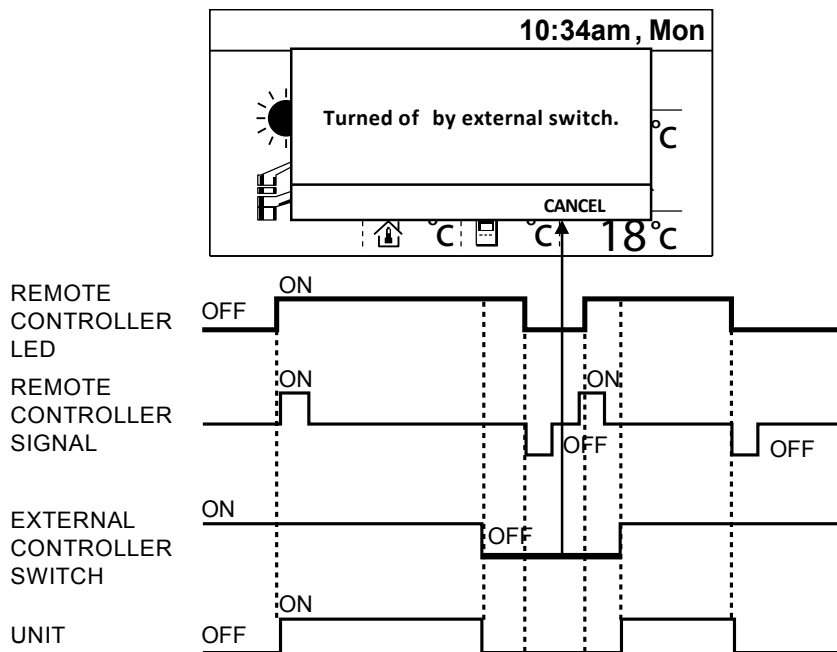

When External SW connection select "YES" from remocon installer menu:

- Heating or Cooling system will operate normally if the External Switch signal is ON.
- Once the External Switch turn OFF, System Turn OFF (Heat pump, water pump, heater etc...)
- Remocon LED remain ON or OFF according to the current operation request.
- Pop up menu at remocon main screen as above screen to inform customer system stop by External Switch.
- It is possible to press cancel and return to main screen to do change of operation setting while waiting the External Switch turn ON back.
- Remocon LED will always follow the latest changes from remocon.
- If no action on remocon for continuous 5 minutes, the pop up screen will show again on the screen.
- But once the External Switch Turn ON back, pop up screen will disappear and system can operate normally according to the latest operation setting and request.

11.25 External Compressor Switch (Optional PCB)

External compressor switch port can have two purpose of control as below:

- Heat source ON/OFF function (Dip switch Pin 3 on PCB "OFF")
- Heater ON/OFF function (Dip switch Pin 3 on PCB "ON")
- Heat source ON/OFF function

Purpose:

- Heat pump ON/OFF function is use to turn OFF the high power consumption device (Heat pump, & Heater) when there is energy or electric current limitation. Other optional function still can be operate under heat pump and heater OFF condition.

Control Detail:

- This External Compressor Switch is possible to connect to Optional PCB only.
- Once the remocon select External Compressor Switch connection "YES", & Dip Switch on PCB "OFF" This heat pump ON/OFF function will activate
- The ON/OFF signal of this External Compressor Switch is same as External Switch.
- When the External Compressor Switch is ON:
 - Heat pump system operate normally
- When the External Compressor Switch is OFF:
 - Heat pump, Indoor water pump & Heater (Booster heater & Backup Heater) need to turn OFF
 - Solar, Boiler and zone control can be operate follow normal control condition.
 - * pump delay OFF also included in this control

(There is NO pop up screen like External Switch when this External Compressor Switch is OFF.)

- Heater ON/OFF function

Purpose:

- Heater ON/OFF function is use to turn OFF the heater (backup heater & booster heater) when there is energy or electric current limitation. Heat pump and other optional function still can operate.

Control detail:

- This External Compressor Switch is possible to connect to Optional PCB only.
- Once the remocon select External Compressor Switch connection "YES", & Dip Switch on PCB "ON" This heater ON/OFF function will activate
- When the External Compressor Switch is ON:
 - Heat pump and heater operate normally
- When the External Compressor Switch is OFF:
 - Backup heater and booster heater cannot operate even heater request is ON.
 - Heat pump and option function (Solar, Boiler and zone control) can be operate follow normal control condition.

(There is NO pop up screen like External Switch when this External Compressor Switch is OFF.)

11.26 Heat/Cool Switch (Optional PCB)

Purpose:

- User can switch the running mode from heat to cool or cool to heat through external installed Heat/Cool switch. This kind of heat / cool switch may built in inside the field supply room remocon as well.

Control contents:

- Heat/Cool Switch can only be set when Cool Function is "enable" at custom menu setting, & Extension PCB select "YES" & Zone 1 not set "Pool" condition.
- This heat/cool switch control will be activate only when installer set the Heat/Cool Switch "USE" through remocon.
- Once the Heat/Cool Switch Set "USE", remocon will check indoor send Signal to judge the option of mode select.
 - When Heat/Cool Switch Contact Open : Remocon only can select Heat Mode, or Heat + Tank Mode, or Tank Mode
 - When Heat/Cool Switch Contact Close : Remocon only can select Cool Mode, or Cool + Tank Mode, or Tank Mode
- Operation ON/OFF will depend on remocon request.
- When Heat Mode is running with Contact Open, user change this setting to contact close, indoor will this signal to remocon judge and change mode to cool and send back to indoor. And it is same as from cool mode change to heat mode.
 - * This switch have higher priority, remocon follow indoor send signal when control activated.
 - * There is no effect to the operation when the mode running is only Tank Mode.

(Weekly Timer are ignored and cannot be set during Heat / Cool Switch is "Enable" Condition.)

11.27 SG Ready Control (Optional PCB)

Purpose:

- To set ON/OFF of heat pump and target temperature by digital input of third party device if necessary in field.

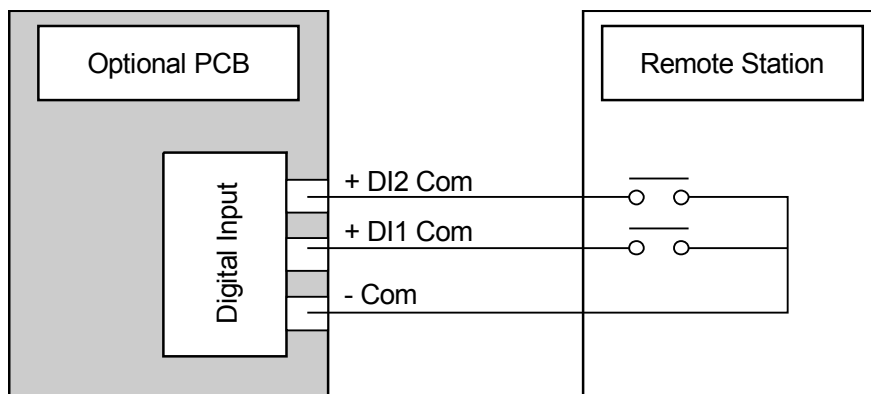

Remote control setting

For this function, following items need to be set on R/C (installer menu) –

- SG control = YES or NO
- Capacity up setting 1
 - Heating capacity [50 ~ 150 %]
 - DHW capacity [50 ~ 150 %]
- Capacity up setting 2
 - Heating capacity [50 ~ 150 %]
 - DHW capacity [50 ~ 150 %]

Control contents:

If SG control on remote control = "Yes", then following control only activate by digital input.

- **While Digital input is " 00 " (Normal operation)**
 - Normal operation. Once detect '00' system will operate back to normal condition.
(All the target set temperature for heating side and DHW side will return back to previous set temperature when digital signal change from "10' or"11" back to "00".)
- **While digital input is detected " 01 " (HP stop)**
 - Heat pump & room heater & tank heater cannot operate.
(Solar control and Boiler back up and 2 Zone control can activate.)
- **While digital input is detected " 10 " (Capacity 1)**
 - Target temperature for heating and DHW Tank is changed according to the percentage set by Remote control setting. However, which setting temperature is change depend on system setting.
- **While digital input is detected " 11 " (Capacity 2)**
 - Target temperature for heating and DHW Tank is changed according to the percentage set by Remote control setting. However, which setting temperature is change depend on system setting.
- **While digital input is detected " 10 " (Capacity 1)**
 - Setting temperature for heating and Tank is changed.
However, which setting temperature is change depend on system setting.

If Buffer selection is "YES"

Room side

New Target Buffer tank temperature = Current Target Buffer Tank Temperature * Remote Control setting (" capacity 1) %

* Max Min regulation is follow Target Buffer tank temperature control specification

** No change of Target zone water temperature, only set higher buffer tank temperature.

DHW Tank side

New Tank Set Temperature = Tank Set Temperature * Remote Control setting for DHW ("Capacity 1) % *
(Max regulation depend on the tank max setting limit)

If Buffer selection is "NO"

Room side

New Target Zone Water Temperature = Current Target Zone Water Temperature * Remote Control Setting (*Capacity 1) %

(Zone 1 and Zone 2 will change according to its own target zone water temperature.)

(Max regulation depend on the temperature control type select)

DHW Tank side

New Tank Set Temperature = Tank Set Temperature * Remote Control setting for DHW ("Capacity 1) %

* (Max regulation depends on the tank max setting limit)

- **While digital input is detected " 11 " (Capacity 2)**
 - Setting temperature for heating and Tank is changed.
However, which setting temperature is change depend on system setting.

If Buffer selection is “YES”

Room side

New Target Buffer tank temperature = Current Target Buffer Tank Temperature * Remote Control setting (" capacity 2) %

* Max Min regulation is follow Target Buffer tank temperature control specification

** No change of Target zone water temperature, only set higher buffer tank temperature.

DHW Tank side

New Tank Set Temperature = Tank Set Temperature * Remote Control setting for DHW ("Capacity 2) %

* (Max regulation depends on the tank max setting limit)

If Buffer selection is “NO”

Room side

New Target Zone Water Temperature = Current Target Zone Water Temperature * Remote Control Setting (*Capacity 2) %

(Zone 1 and Zone 2 will change according to it's own target zone water temperature.)

(Max regulation depend on the temperature control type select)

DHW Tank side

New Tank Set Temperature = Tank Set Temperature * Remote Control setting for DHW ("Capacity 2) %

* (Max regulation depends on the tank max setting limit)

** This function is not applicable for Cooling mode.

11.28 Demand Control (Optional PCB)

Remote control setting:

- When Optional PCB connection select 'YES", Demand Control function can select "YES" or "NO".

Purpose:

- After the demand control select YES, below control will activated.
 - 0-10V Demand control

0-10V Demand control

- Demand control is use to reduce the current usage of heat pump unit by third party device.

Control start condition:

- Select “YES” at Demand control at installer menu.
- 0-10V input for this electrical current control is detected.

Control content:

- If start condition is fulfilled, indoor will receive the voltage signal from optional PCB. Indoor will send the rate value to outdoor unit.
- Outdoor will change the current limit according to the percentage receive from indoor unit.

11.29 Holiday Mode

- Purpose:

Promotes energy saving by allowing the user to stop the system during holiday and enables the system to resume at the preset temperature after holiday.

- Control details:

- Indoor operate the unit according running mode request. Target temperature will follow holiday setting temperature.
 - If heat mode request is receive, Target Water Out Temperature will change according to holiday shift temperature set.
[If heat is set OFF at holiday, unit, water pump and zone control will OFF]
 - If tank mode request is receive, Target Tank Set Temperature will change according to the holiday tank shift temperature set.
[If tank is set OFF at holiday, heat pump and tank heater will OFF]
- After days of holiday have been set, heat pump will stop and only resume operation at the end of holiday countdown.

- Start condition:

- Holiday timer set and the holiday timer start
 - * The day holiday mode was set is counted as day 1.

- Stop condition:
 - OFF/ON button is pressed.
 - Holiday timer is reached.

11.30 Dry Concrete

- Purpose
Provide heat to floor heating panel and dry the wet concrete during installation.
- Setting condition:
 - Dry concrete parameter can be set through remote control under system setup.
 - Parameters are possible to set up to 99 days with different target set temperature
- Control details:
 - Dry concrete mode will be activates when select ON from service setup.
 - Once start dry concrete function, remote control will send step 1 setting temperature to indoor unit.
* This temperature is set at zone temperature. If system is 2 zones, both zone target temperature is set as same temperature.
 - Heat pump will start heat mode operation to room side with received target water outlet temperature.
* Heat pump will operate according to Heat pump Target Water Temperature.
 - After complete day 1 setup operation, day 2 data will be send to indoor at 12.00am on the second day.
 - Each preset data will be send every day until dry concrete mode is complete, unit will turns OFF and exit dry concrete function.
 - 3 ways valve and booster heater will turn OFF and 2 ways valve will turns ON.
- Cancel condition:
 - Dry concrete mode is complete and OFF signal is received.
 - OFF signal is received by pressing OFF/ON button.

11.31 Flow Sensor

- The water flow sensor serves as an overload protector that shuts down the unit when the water level is detected to be low.
- Abnormal flow detection:

Sequence	Abnormal flow	Normal flow
Normal case	Flow rate < 11 l/min or ≥ 69 l/min	≥ 11 l/min
During status 2~6 on Anti-freeze deice	Flow rate ≥ 11 l/min	< 11 l/min

12. Protection Control (WH-UQ09HE8, WH-UQ12HE8 and WH-UQ16HE8)

12.1 Protection Control for All Operations

12.1.1 Time Delay Safety Control

- 1 The compressor will not start for three minutes after stop of operation.

12.1.2 30 Seconds Forced Operation

- 1 Once the compressor starts operation, it will not stop its operation for 30 seconds.
- 2 However, it can be stopped using control panel at indoor unit.

12.1.3 Total Running Current Control

- 1 When the outdoor running current exceeds X value, the compressor frequency will decrease.
- 2 If the outdoor running current does not exceed X value, the compressor frequency will return to normal operating frequency.
- 3 If the outdoor running current continue to increase till exceed Y value, compressor will stop, and if this occurs 3 times within 20 minutes, system will stop operation and OFF/ON control panel LED will blink (F16 error occurs).

Operation Mode	UQ09HE8		UQ12HE8		UQ16HE8	
	X (A)	Y (A)	X (A)	Y (A)	X (A)	Y (A)
Heating	9.4	11.8	10.9	11.8	15.5	16.5
Cooling	6.2	11.8	6.2	11.8	7.1	16.5

A. DC Peak Current Control

- 1 When the current to IPM exceeds set value of 34 A (For UQ09HE8, UQ12HE8) and 54.0 +/- 4.0 A (For UQ16HE8), compressor will stop. Compressor will restart after three minutes.
- 2 If the set value exceeds again for more than 30 seconds after the compressor restarts, operation will restart after two minutes.
- 3 If the set value exceeds again for within 30 seconds after the compressor restarts, operation will restart after one minute. If this condition repeats continuously for seven times, system will stop operation and OFF/ON control panel LED will blink (F23 error occurs).

12.1.4 Compressor Overheating Prevention Control

- The compressor operating frequency is regulated in accordance to compressor tank temperature as shown in below figures. When the compressor tank temperature exceeds 107°C, compressor will stop, and if this occurs 4 times within 30 minutes, system will stop operation and OFF/ON control panel LED will blink (F20 error occurs).

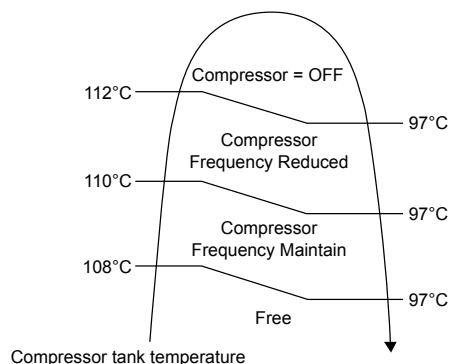

12.1.5 High Pressure Sensor Control

- Purpose:
 - To protect the system operation.
- Detection period:
 - After compressor on for 1 minute.
- Detection conditions:
 - When abnormal high voltage detection, 5 V or when open circuit detection 0V for 5 seconds continuously.
- After detection:
 - When abnormality is detected 4 times within 120 minutes, unit stop operation.
 - OFF/ON control panel LED will blink (H64 error occurs).

12.1.6 Outside Temperature Current Control

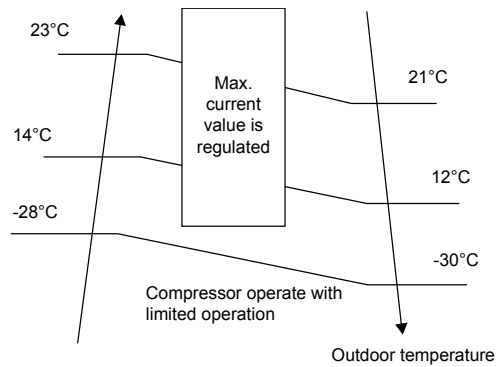

12.1.7 Crank Case Heater Control

- Purpose:
 - For compressor protection during low outdoor ambient operation (during heating low temperature operation).
- Control content:
 - a. Trigger heater START condition
 - When the outdoor air temperature is below than 5°C, and discharge temperature is 11°C or below.
 - b. Resetting heater STOP condition
 1. When the outdoor air temperature exceeds entry condition (2°C)
 2. When the discharge temperature exceeds entry condition (5°C)

12.1.8 Compressor Cold Start Prohibition Control

- Purpose:
 - Protect compressor when poor compressor oil return at low outdoor ambient and high water temperature condition.
- Control content:
 - Do not run compressor when below condition fulfilled
 - a. Compressor top temperature < 10°C
 - b. Outdoor ambient < -20°C
 - c. Water temperature > 40°C

12.2 Protection Control for Heating Operation

12.2.1 Outdoor Air Temperature Control

The maximum current value is regulated when the outdoor air temperature rises above 14°C in order to avoid compressor overloading.

12.2.2 Deice Operation

When outdoor pipe temperature and outdoor air temperature is low, deice operation start where outdoor fan motor stop.

- Deice judging condition

Outdoor Unit Deice Control

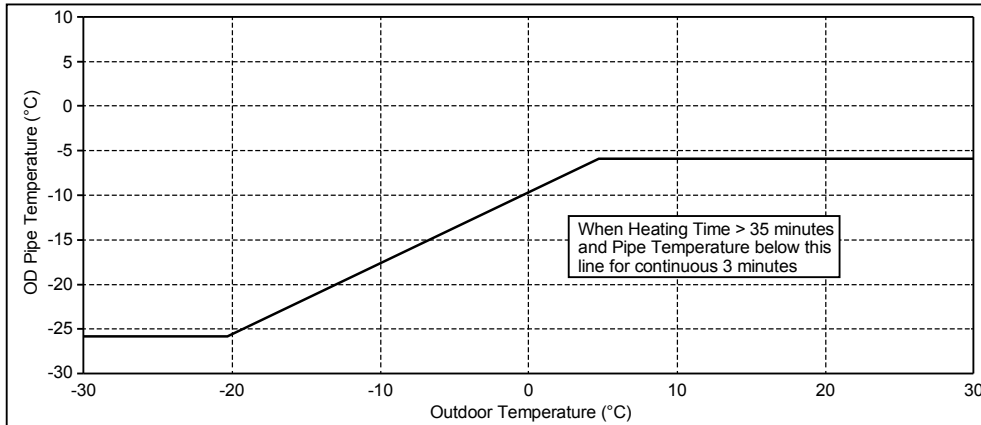

Deice start depends:

1. Outdoor air sensor temp.
2. Outdoor pipe sensor temp.
3. Heating accumulation time

- Deice mode selection condition

- There are 2 deice modes, according to water inlet temperature and outdoor ambient temperature the deice mode is decided.

Water inlet temperature

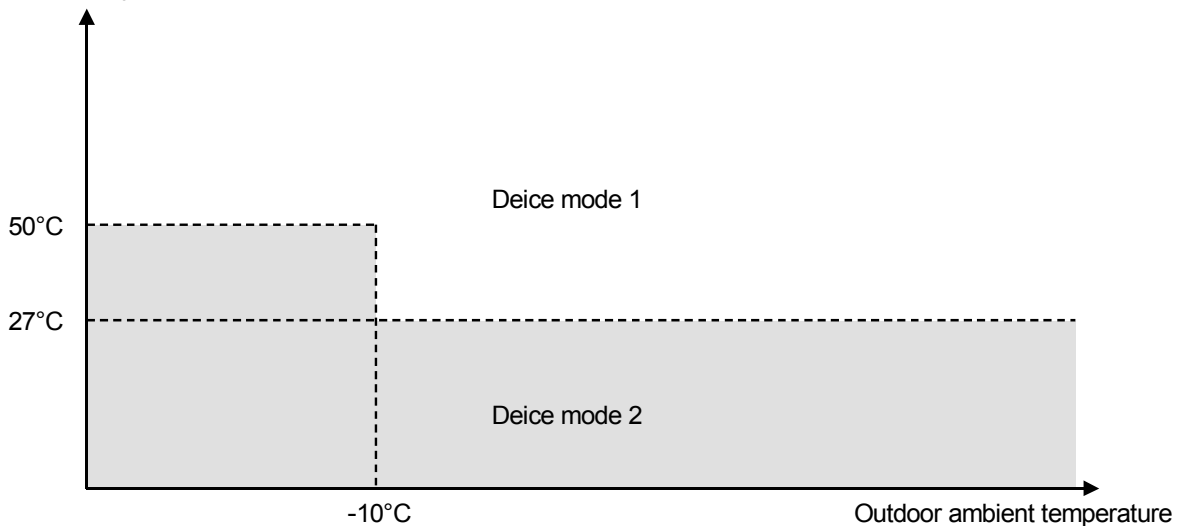

Judgement details:

- 1) When water inlet temperature is more than 50°C, unit will operate deice mode 1.
- 2) When water inlet temperature is less than 27°C, unit will operate deice mode 2.
- 3) When water inlet temperature is less than 50°C and outdoor ambient temperature is less than -10°C, unit will operate deice mode 2.
- 4) When water outlet temperature sensor 2 detect temperature is less than 22°C, unit will operate deice mode 2.

- Deice operation time diagram

- a. Deice mode 1 control:

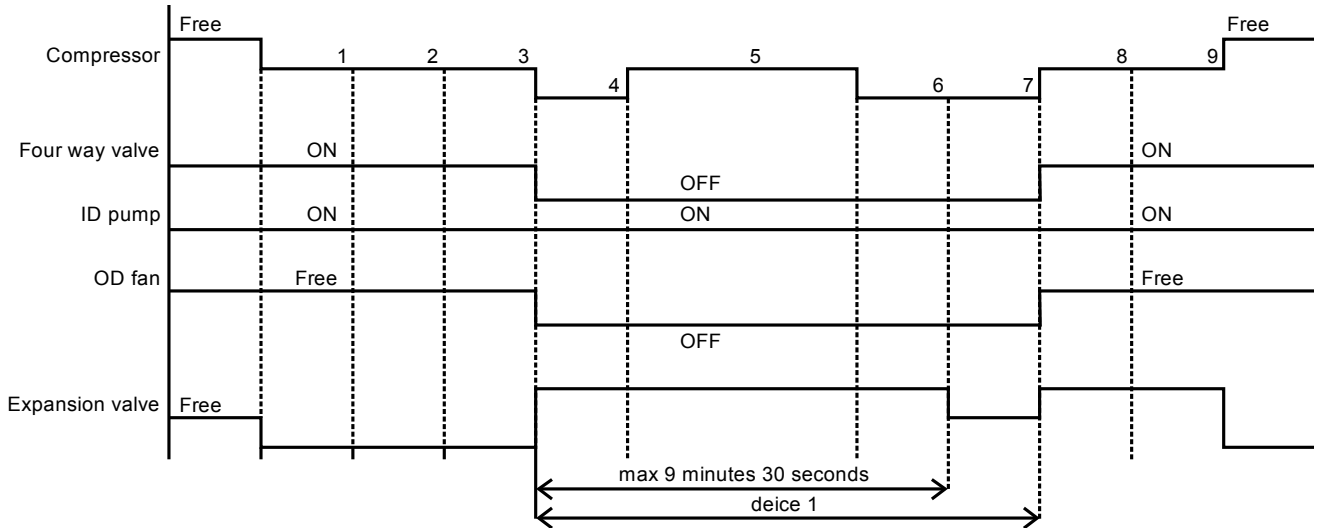

- b. Deice mode 2 control:

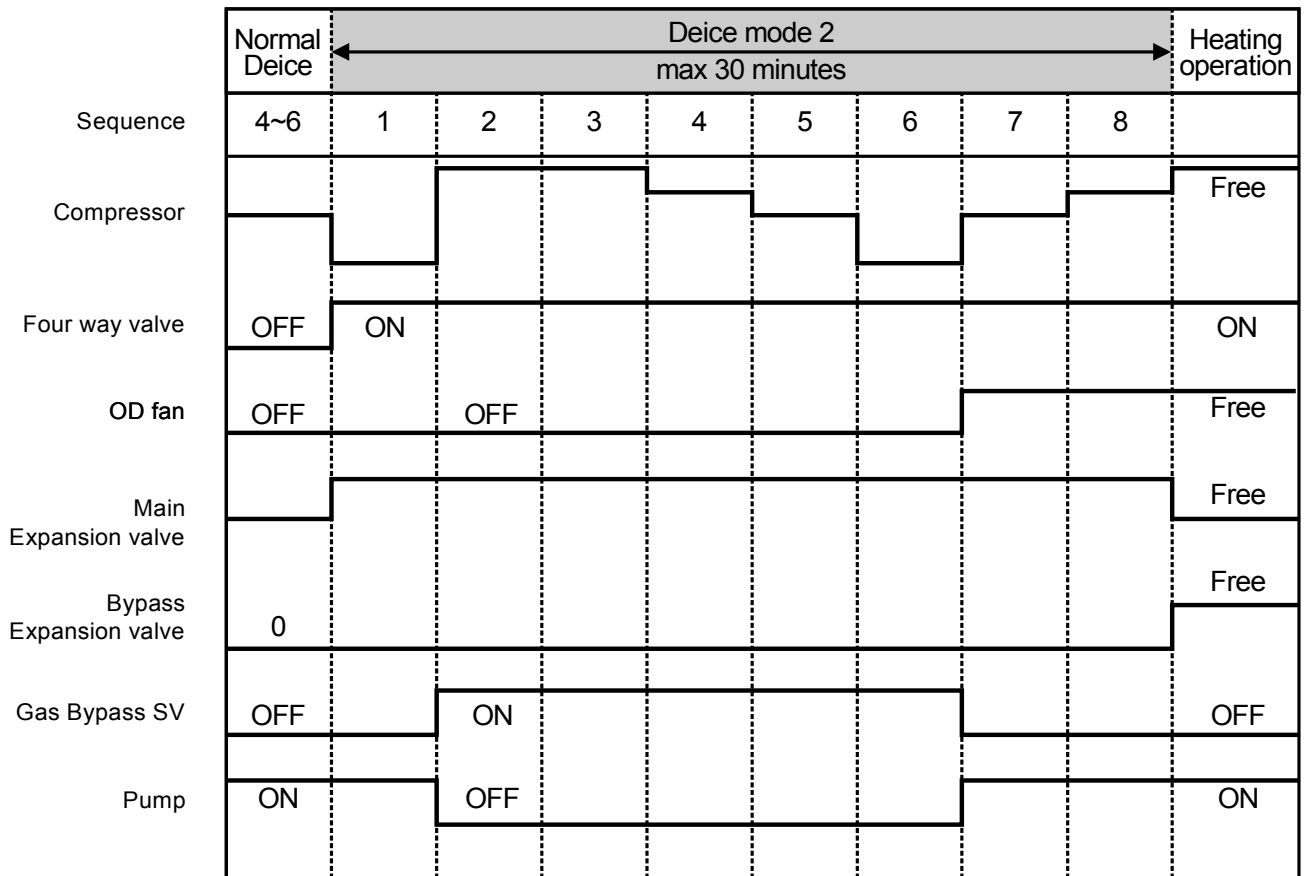

12.3 Protection Control for Cooling Operation

12.3.1 Outdoor Air Temperature Control

- The Compressor operating frequency is regulated in accordance to the outdoor air temperature as shown in the diagram below.
- This control will begin 1 minute after the compressor starts.
- Compressor frequency will adjust base on outdoor air temperature.

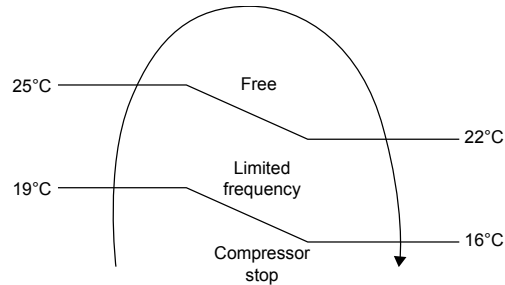

12.3.2 Freeze Prevention Control 1

- 1 When indoor heat exchanger temperature is lower than 0°C continuously for 10 seconds, compressor will stop operating.
- 2 Compressor will resume its operation three minutes after the indoor heat exchanger is higher than 1°C.
- 3 Indoor heat exchanger freeze prevention (H99) will memory in error history.

13. Protection Control (WH-UX09HE8, WH-UX12HE8 and WH-UX16HE8)

13.1 Protection Control for All Operations

13.1.1 Time Delay Safety Control

- 2 The compressor will not start for three minutes after stop of operation.

13.1.2 30 Seconds Forced Operation

- 3 Once the compressor starts operation, it will not stop its operation for 30 seconds.
- 4 However, it can be stopped using control panel at indoor unit.

13.1.3 Total Running Current Control

- 4 When the outdoor running current exceeds X value, the compressor frequency will decrease.
- 5 If the outdoor running current does not exceed X value, the compressor frequency will return to normal operating frequency.
- 6 If the outdoor running current continue to increase till exceed Y value, compressor will stop, and if this occurs 3 times within 20 minutes, system will stop operation and OFF/ON control panel LED will blink (F16 error occurs).

Operation Mode	UX09HE8		UX12HE8		UX16HE8	
	X (A)	Y (A)	X (A)	Y (A)	X (A)	Y (A)
Heating	9.4	11.8	10.9	11.8	15.5	16.5
Cooling	6.2	11.8	6.2	11.8	7.1	16.5

B. DC Peak Current Control

- 4 When the current to IPM exceeds set value of 34 A, compressor will stop. Compressor will restart after three minutes.
- 5 If the set value exceeds again for more than 30 seconds after the compressor restarts, operation will restart after two minutes.
- 6 If the set value exceeds again for within 30 seconds after the compressor restarts, operation will restart after one minute. If this condition repeats continuously for seven times, system will stop operation and OFF/ON control panel LED will blink (F23 error occurs).

13.1.4 Compressor Overheating Prevention Control

- The compressor operating frequency is regulated in accordance to compressor tank temperature as shown in below figures. When the compressor tank temperature exceeds 107°C, compressor will stop, and if this occurs 4 times within 30 minutes, system will stop operation and OFF/ON control panel LED will blink (F20 error occurs).

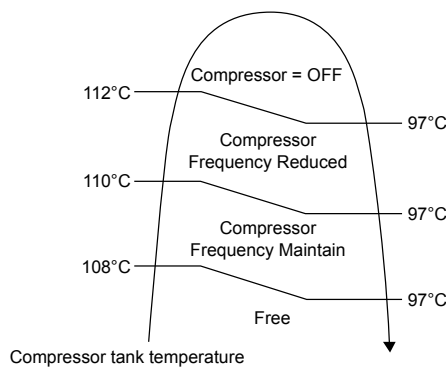

13.1.5 High Pressure Sensor Control

- Purpose:
 - To protect the system operation.
- Detection period:
 - After compressor on for 1 minute.
- Detection conditions:
 - When abnormal high voltage detection, 5 V or when open circuit detection 0V for 5 seconds continuously.
- After detection:
 - When abnormality is detected 4 times within 120 minutes, unit stop operation.
 - OFF/ON control panel LED will blink (H64 error occurs).

13.1.6 Outside Temperature Current Control

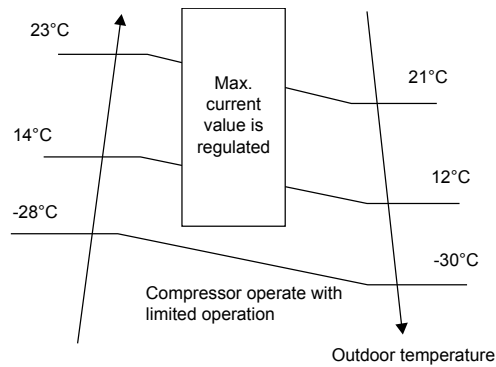

13.1.7 Crank Case Heater Control

- Purpose:
 - For compressor protection during low outdoor ambient operation (during heating low temperature operation).
- Control content:
 - Trigger heater START condition
 - When the outdoor air temperature is below than 5°C, and discharge temperature is 11°C or below.
 - Resetting heater STOP condition
 - When the outdoor air temperature exceeds entry condition (2°C)
 - When the discharge temperature exceeds entry condition (5°C)

13.1.8 Compressor Cold Start Prohibition Control

- Purpose:
 - Protect compressor when poor compressor oil return at low outdoor ambient and high water temperature condition.
- Control content:
 - Do not run compressor when below condition fulfilled
 - Compressor top temperature < 10°C
 - Outdoor ambient < -20°C
 - Water temperature > 40°C

13.2 Protection Control for Heating Operation

13.2.1 Outdoor Air Temperature Control

The maximum current value is regulated when the outdoor air temperature rises above 14°C in order to avoid compressor overloading.

13.2.2 Deice Operation

When outdoor pipe temperature and outdoor air temperature is low, deice operation start where outdoor fan motor stop.

- Deice judging condition

Outdoor Unit Deice Control

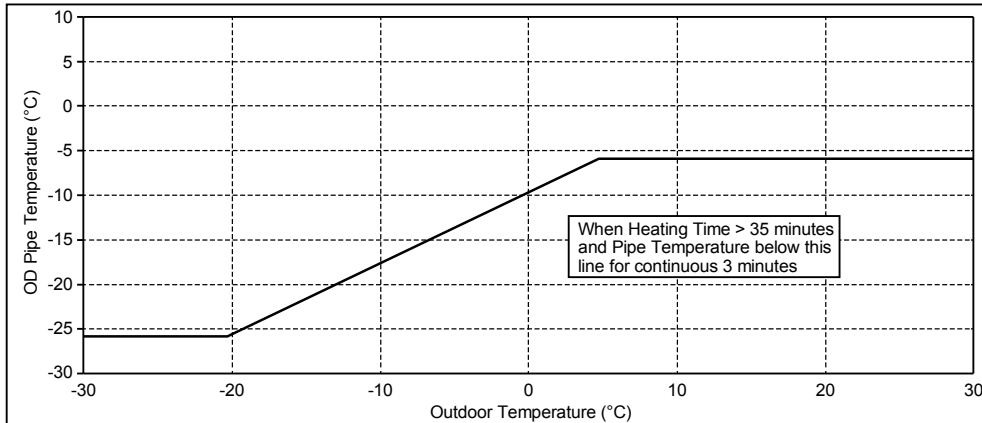

- Deice start depends:
1. Outdoor air sensor temp.
 2. Outdoor pipe sensor temp.
 3. Heating accumulation time

- Deice mode selection condition
 - There are 2 deice modes, according to water inlet temperature and outdoor ambient temperature the deice mode is decided.

Water inlet temperature

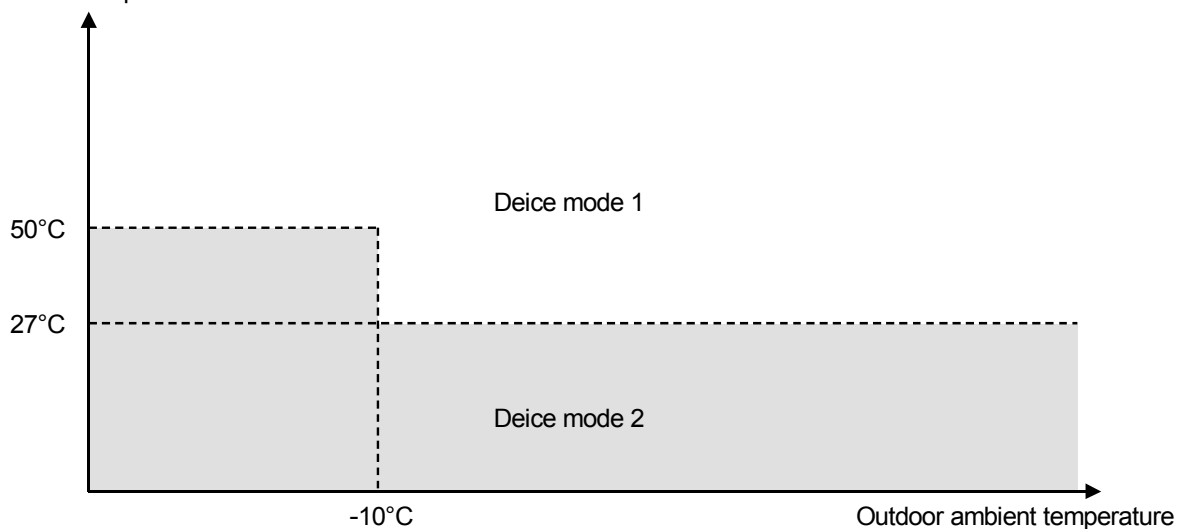

Judgement details:

- 1) When water inlet temperature is more than 50°C, unit will operate deice mode 1.
- 2) When water inlet temperature is less than 27°C, unit will operate deice mode 2.
- 3) When water inlet temperature is less than 50°C and outdoor ambient temperature is less than -10°C, unit will operate deice mode 2.
- 4) When water outlet temperature sensor 2 detect temperature is less than 22°C, unit will operate deice mode 2.

- Deice operation time diagram

c. Deice mode 1 control:

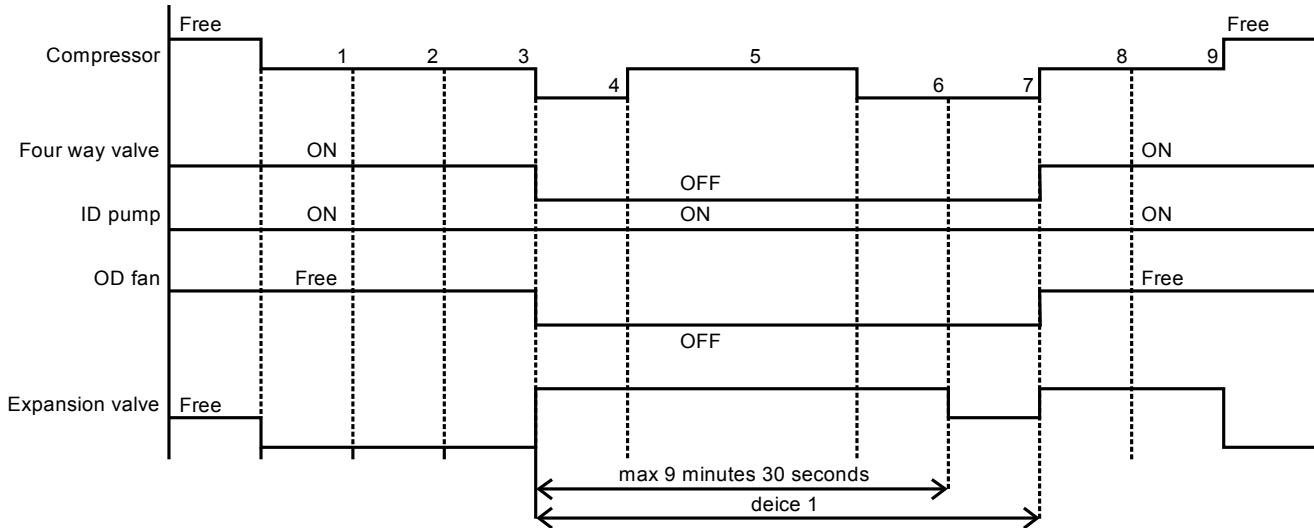

d. Deice mode 2 control:

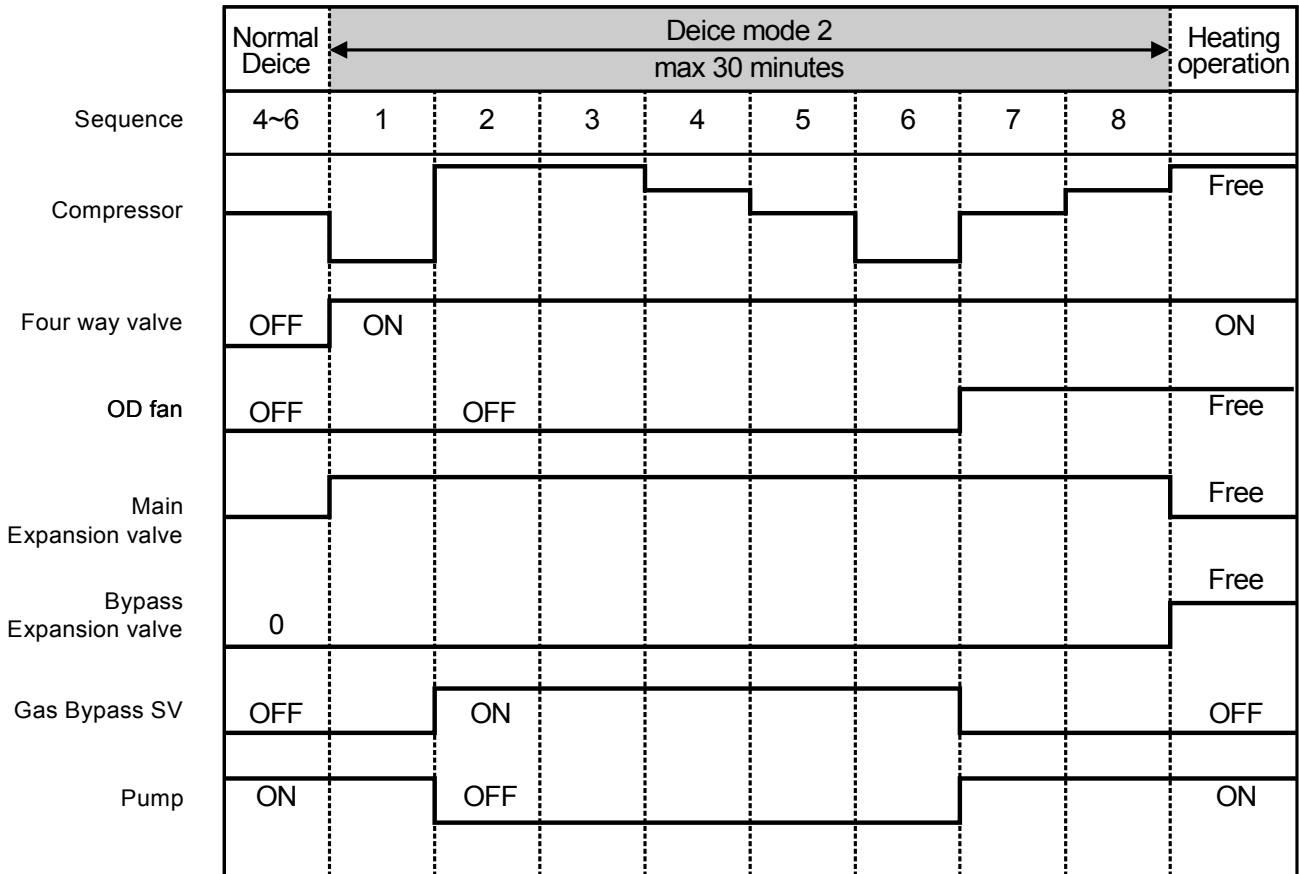

13.3 Protection Control for Cooling Operation

13.3.1 Outdoor Air Temperature Control

- The Compressor operating frequency is regulated in accordance to the outdoor air temperature as shown in the diagram below.
- This control will begin 1 minute after the compressor starts.
- Compressor frequency will adjust base on outdoor air temperature.

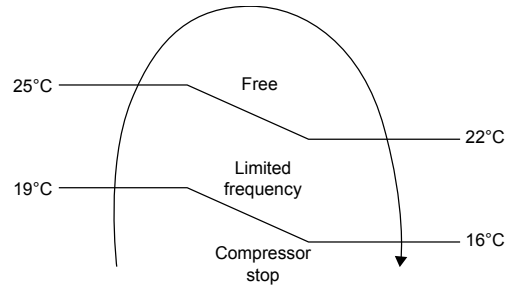

13.3.2 Freeze Prevention Control 1

- 4 When indoor heat exchanger temperature is lower than 0°C continuously for 10 seconds, compressor will stop operating.
- 5 Compressor will resume its operation three minutes after the indoor heat exchanger is higher than 1°C.
- 6 Indoor heat exchanger freeze prevention (H99) will memory in error history.

14. Protection Control (WH-UD09HE8, WH-UD12HE8 and WH-UD16HE8)

14.1 Protection Control for All Operations

14.1.1 Time Delay Safety Control

- 1 The compressor will not start for three minutes after stop of operation.

14.1.2 30 Seconds Forced Operation

- 1 Once the compressor starts operation, it will not stop its operation for 30 seconds.
- 2 However, it can be stopped using control panel at indoor unit.

14.1.3 Total Running Current Control

- 1 When the outdoor running current exceeds X value, the compressor frequency will decrease.
- 2 If the outdoor running current does not exceed X value, the compressor frequency will return to normal operating frequency.
- 3 If the outdoor running current continue to increase till exceed Y value, compressor will stop, and if this occurs 3 times within 20 minutes, system will stop operation and OFF/ON control panel LED will blink (F16 error occurs).

Operation Mode	UD09HE8		UD12HE8		UD16HE8	
	X (A)	Y (A)	X (A)	Y (A)	X (A)	Y (A)
Heating	7.3	10.6	7.3	10.6	8.4	10.6
Cooling	6.2	10.6	6.5	10.6	8.4	10.6

A. DC Peak Current Control

- 1 When the current to IPM exceeds set value of 34 A, compressor will stop. Compressor will restart after three minutes.
- 2 If the set value exceeds again for more than 30 seconds after the compressor restarts, operation will restart after two minutes.
- 3 If the set value exceeds again for within 30 seconds after the compressor restarts, operation will restart after one minute. If this condition repeats continuously for seven times, system will stop operation and OFF/ON control panel LED will blink (F23 error occurs).

14.1.4 Compressor Overheating Prevention Control

- The compressor operating frequency is regulated in accordance to compressor tank temperature as shown in below figures. When the compressor tank temperature exceeds 107°C, compressor will stop, and if this occurs 4 times within 30 minutes, system will stop operation and OFF/ON control panel LED will blink (F20 error occurs).

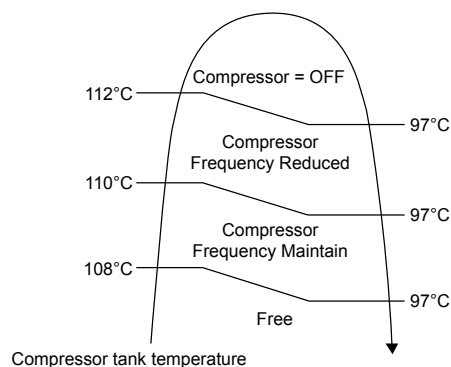

14.1.5 High Pressure Sensor Control

- Purpose:
 - To protect the system operation.
- Detection period:
 - After compressor on for 1 minute.
- Detection conditions:
 - When abnormal high voltage detection, 5 V or when open circuit detection 0V for 5 seconds continuously.
- After detection:
 - When abnormality is detected 4 times within 120 minutes, unit stop operation.
 - OFF/ON control panel LED will blink (H64 error occurs).

14.1.6 Outside Temperature Current Control

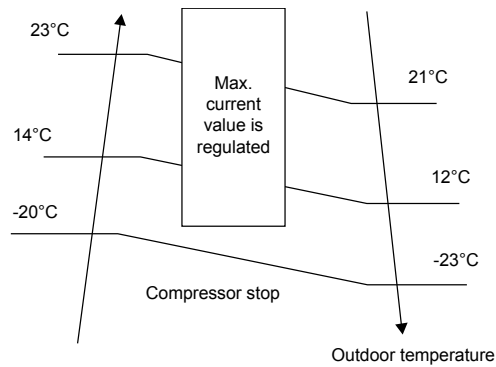

14.1.7 Crank Case Heater Control

- Purpose:
 - For compressor protection during low outdoor ambient operation (during heating low temperature operation).
- Control content:
 - a. Trigger heater START condition
 - When the outdoor air temperature is below than 5°C, and discharge temperature is 11°C or below.
 - b. Resetting heater STOP condition
 1. When the outdoor air temperature exceeds entry condition (2°C)
 2. When the discharge temperature exceeds entry condition (5°C)

14.2 Protection Control for Heating Operation

14.2.1 Outdoor Air Temperature Control

The maximum current value is regulated when the outdoor air temperature rises above 14°C in order to avoid compressor overloading.

14.2.2 Deice Operation

When outdoor pipe temperature and outdoor air temperature is low, deice operation start where outdoor fan motor stop.

- Deice judging condition

Outdoor Unit Deice Control

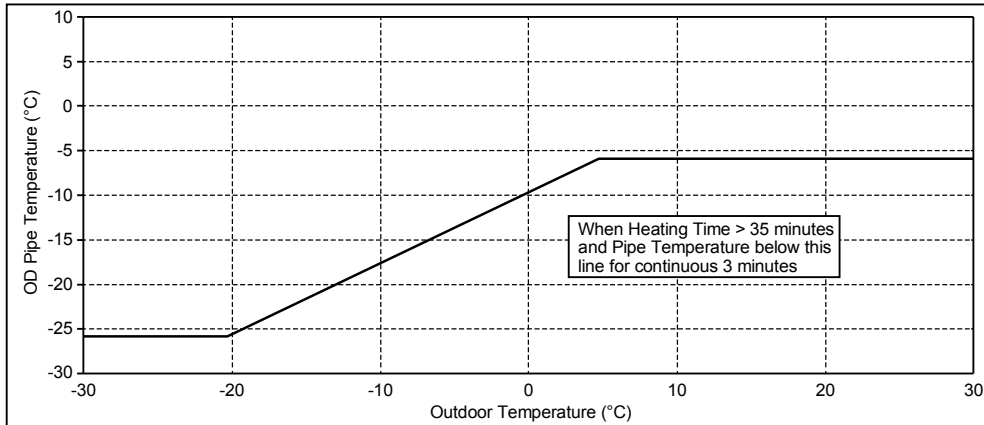

Deice start depends:

1. Outdoor air sensor temp.
2. Outdoor pipe sensor temp.
3. Heating accumulation time

- Deice operation time diagram

a. Deice mode 1 control:

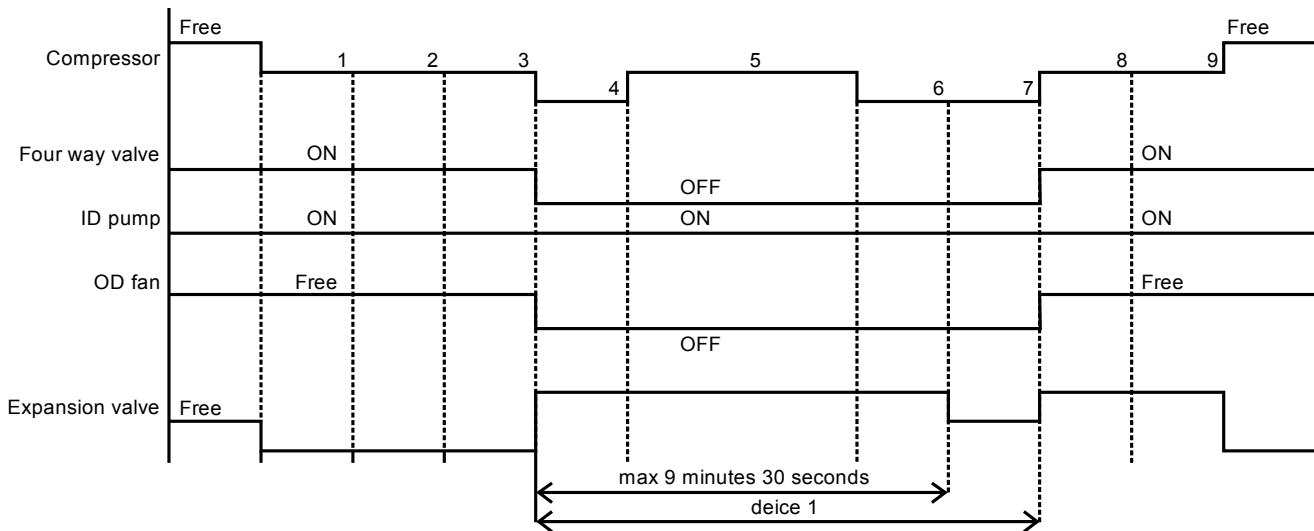

14.3 Protection Control for Cooling Operation

14.3.1 Outdoor Air Temperature Control

- The Compressor operating frequency is regulated in accordance to the outdoor air temperature as shown in the diagram below.
- This control will begin 1 minute after the compressor starts.
- Compressor frequency will adjust base on outdoor air temperature.

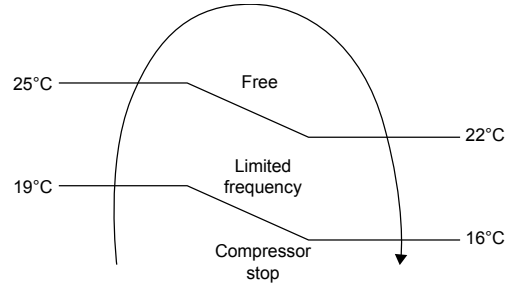

14.3.2 Freeze Prevention Control 1

- 1 When indoor heat exchanger temperature is lower than 0°C continuously for 10 seconds, compressor will stop operating.
- 2 Compressor will resume its operation three minutes after the indoor heat exchanger is higher than 1°C.
- 3 Indoor heat exchanger freeze prevention (H99) will memory in error history.

15. Servicing Guide

15.1 How to take out Front Plate

Open and Close Front Plate

- 1 Remove the 2 mounting screws of Bottom Front Plate.
- 2 Slide it upwards to unhook the Bottom Front Plate hook.
- 3 Reverse above steps 1~2 for close it.

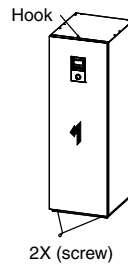

15.2 Test Run

- 1 Before test run, make sure below items have been checked:-
 - Pipework are properly done.
 - Electric cable connecting work are properly done.
 - Tank Unit is filled up with water and trapped air is released.
 - Please turn on the power supply after filling the tank until full.
 - In order to check whether the tank is full, switch heater once for about 10 min.
- 2 Switch ON the power supply of the Tank Unit. Set the Tank Unit RCCB/ELCB to "ON" condition. Then, please refer to the Operation Instruction for operation of Remote Controller.
- 3 For normal operation, Water Pressure Gauge reading should be in between 0.05 MPa and 0.3 MPa. If necessary, adjust the Water Pump SPEED accordingly to obtain normal water pressure operating range. If adjust Water Pump SPEED cannot solve the problem, contact your local authorized dealer.
- 4 After test run, please clean the Water Filter Set. Reinstall it after finish cleaning.

15.3 Expansion Vessel Pre Pressure Checking

[Lower limit water volume of the system]

Please ensure the capacity of the circulating water of the total system including the capacity of the indoor unit is more than 30 L.

If the water capacity is insufficient, during deice operation, the water temperature is lowered and the water will freeze in the system's component leading to product failure.

[Upper limit water volume of the system]

The indoor unit has a build-in Expansion Vessel with 10 L air capacity and initial pressure of 1 bar.

Total amount of water in the system should be below 200 L. If the total amount of water is more than 200 L, please add expansion vessel (field supply). The expansion vessel capacity required for the system can be calculated from the formula below.

$$V = \frac{\varepsilon \times V_0}{1 - \frac{98 + P_1}{98 + P_2}}$$

- V : Required gas volume
<expansion vessel volume L>
- V₀ : System total water volume <L>
- ε : Water expansion rate 5 → 60°C = 0.0171
- P₁ : Expansion tank filling pressure = (100) kPa
- P₂ : System maximum pressure = 300 kPa
- () Please confirm at actual place
- The gas volume of the sealed type expansion vessel is presented by <V>.
- It's advised to add 10% margin for required gas volume of calculation.

Water expansion rate table

Water temperature (°C)	Water expansion rate ε
10	0.0003
20	0.0019
30	0.0044
40	0.0078
50	0.0121
60	0.0171
70	0.0228
80	0.0291
90	0.0360

[Adjustment of the initial pressure of the expansion vessel when there is a difference in installation height]
If the height difference between the indoor unit and the highest point of the system water circuit (H) is more than 7m, please adjust the initial pressure of the expansion vessel (Pg) according to the following formula.

$$P_g = (H \times 10 + 30) \text{ kPa}$$

15.4 Pump Down Procedures

Refer below steps for proper pump down procedure.

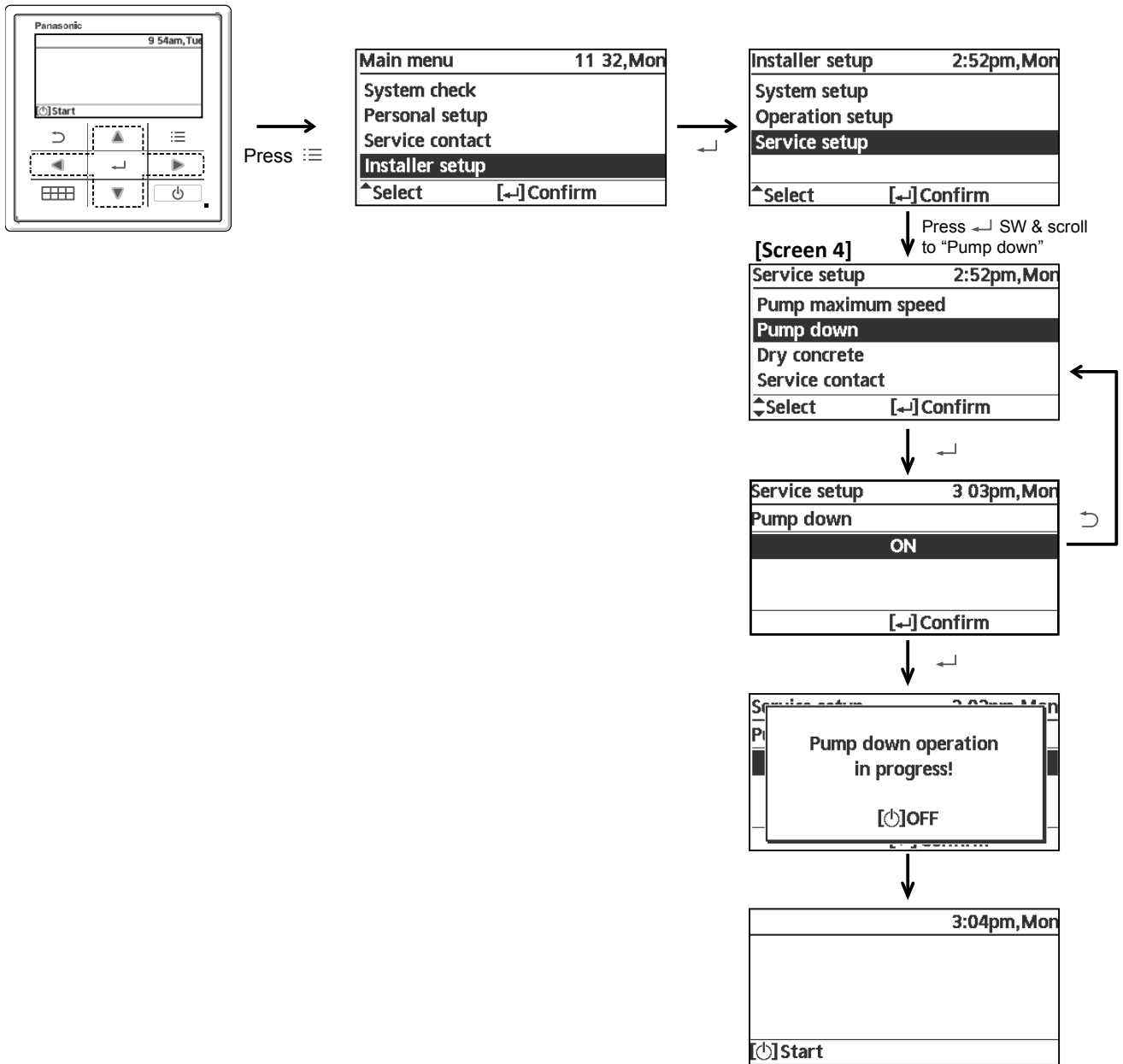

15.5 How To Adjust Pump Speed

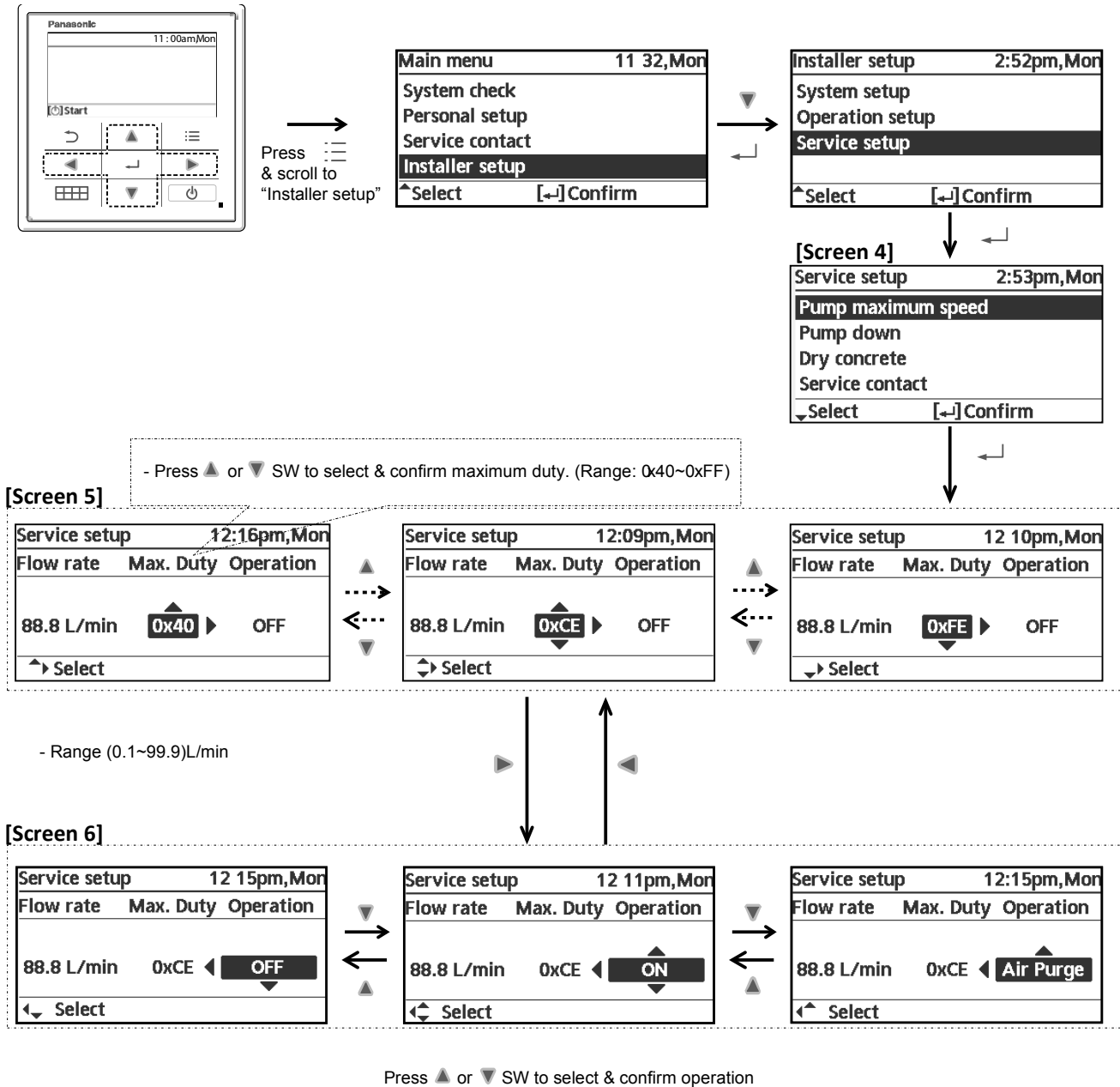

NOTE:

1. Whenever at [Screen 5], if press SW to OFF, pump operation should be turned OFF.
2. Whenever at [Screen 6], if press SW to OFF, pump operation should be turned OFF.

15.6 How To Unlock Cool Mode

Operation must be OFF

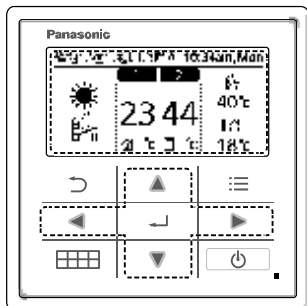

Press (☰ + ▼ + ◀) SW's continuously for 5secs

Custom menu	3:24pm, Mon
Cool mode	
Back-up heater	
Reset energy monitor	
Reset operation history	
▼Select	[↔] Confirm

Display latest status retrieved from EEPROM

Custom menu	3 24pm, Mon
Cool mode	
Enable	
Disable	
▼Select	[↔] Confirm

Custom menu	3:25pm, Mon
Cool mode	
Enable	
Disable	
▲Select	[↔] Confirm

15.7 EEPROM Factory Default Data Setup Procedure

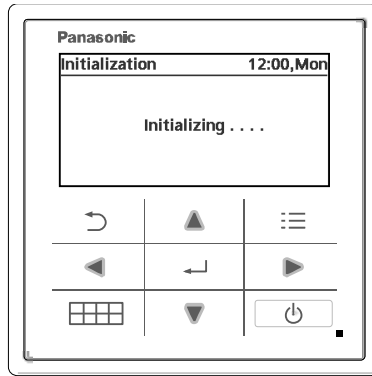

- EEPROM default data setup is only possible during initialization process.
- Press (▲ , ▼ , ◀ , ▶) simultaneously for 5secs continuously, initialization process will stop & EEPROM default data setup process will start.

During EEPROM default data setup process, display should be as shown below.

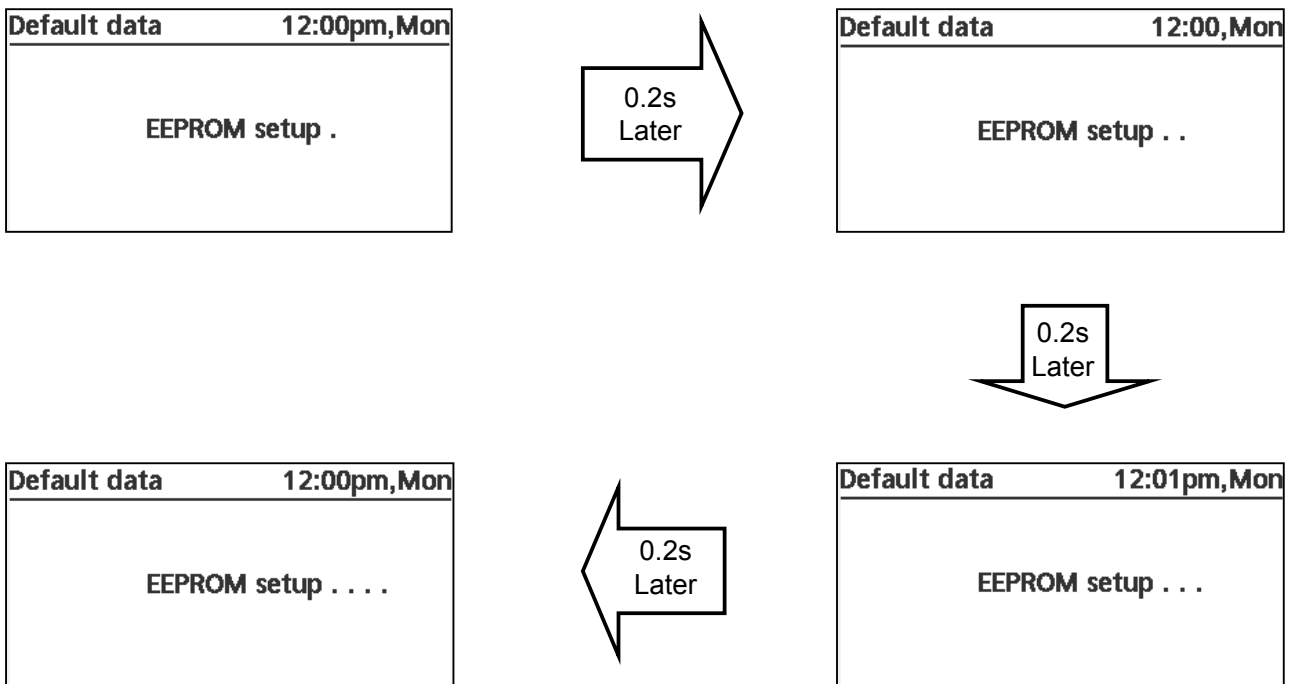

- Once EEPROM default data setup process is complete, initialization process will re-start from beginning.

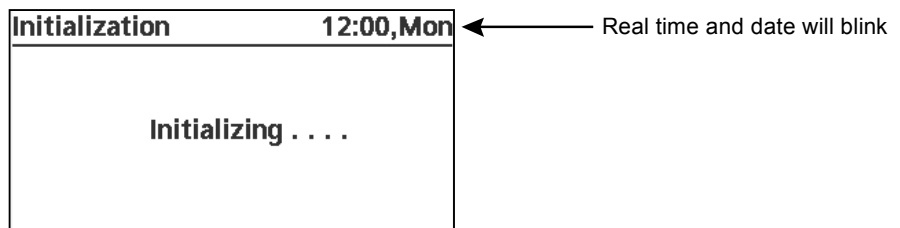

15.8 Dry Concrete Setup

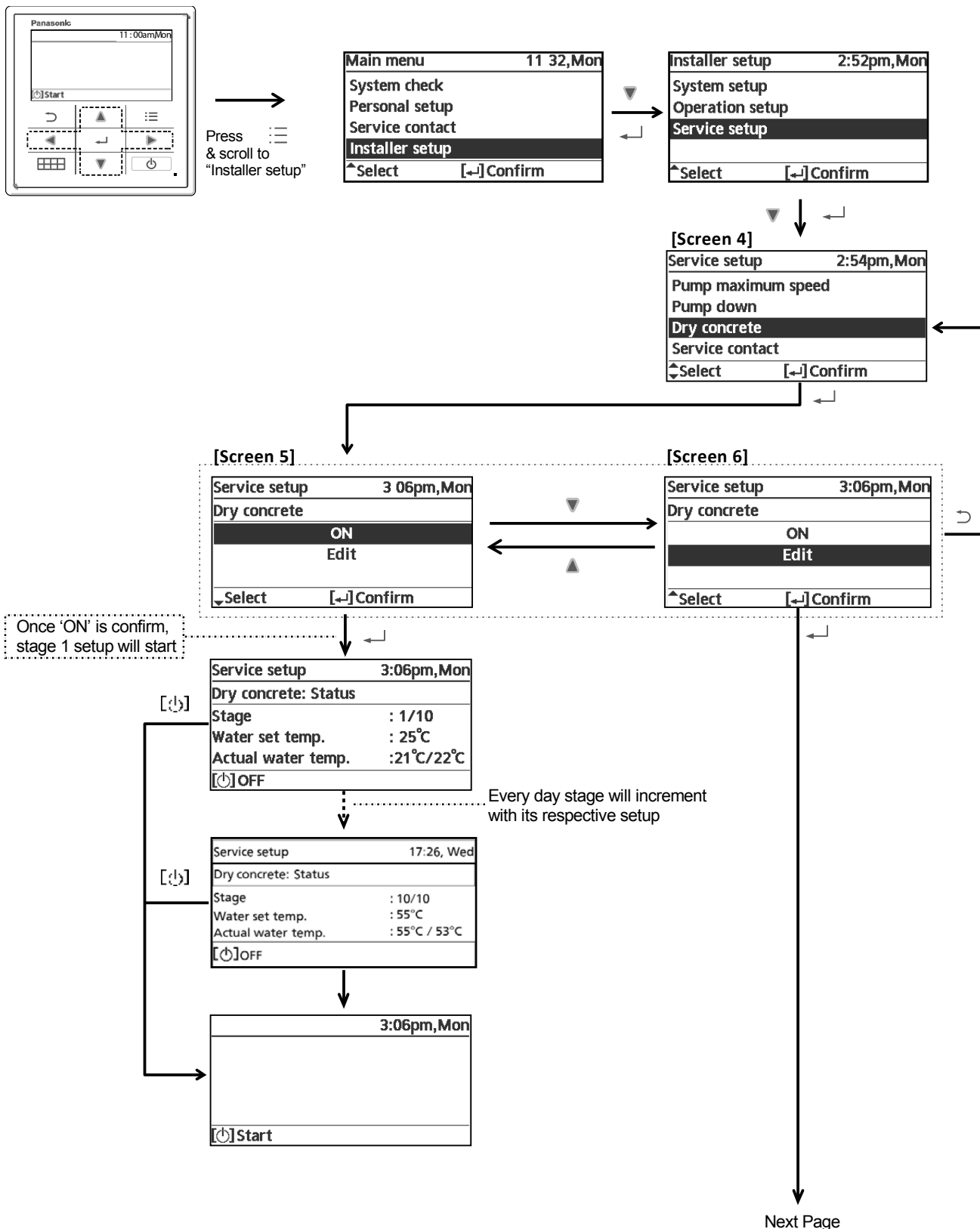

- Press ▲ or ▼ button to select no. of stages.
 - Press ↵ to store latest status.
 - Press ⏪ button, display will return to [Screen 6].

- If suppose to select 10 stages, then setup will start from stage 1/10.
 - Press ▲ or ▼ button to select set temperature.
 - Press ↵ button to store latest status.

- Move to next stage 2/10
 - Repeat the same procedure

- Move to next stage 10/10
 - Repeat the same procedure.
 - Press ↵ to store latest status the the display will return to [Screen 4]
 - Press ⏪ button to return to stage 9/10.

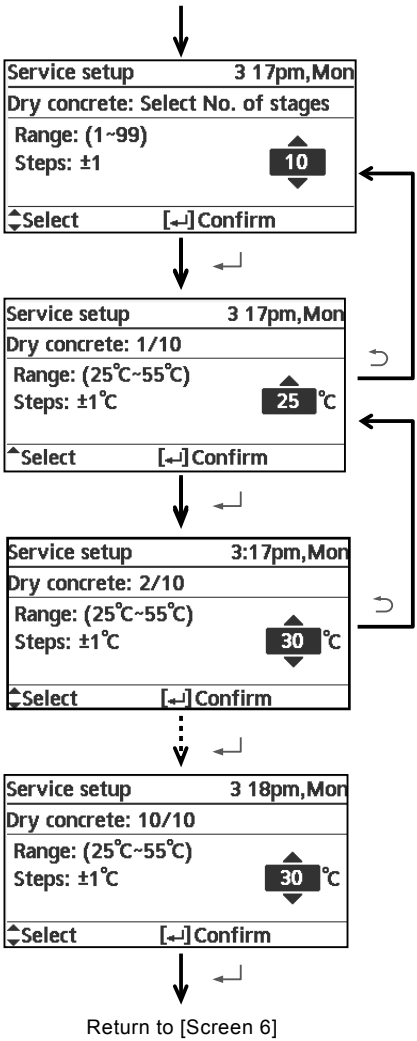

16. Maintenance Guide

In order to ensure safety and optimal performance of the Tank Unit, seasonal inspections on the Tank Unit, functional check of RCCB/ELCB, field wiring and piping have to be carried out at regular intervals. This maintenance should be carried out by authorized dealer. Contact dealer for scheduled inspection.

1 Charging and Discharging the Water

Make sure all the piping installations are properly done before carry out below steps.

Charge the Water

- For domestic hot water tank
 - a. Set the Domestic Hot Water Tank Discharge Valve to "CLOSE".

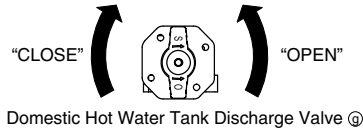

- b. Set all Tap / Shower "OPEN".
- c. Start filling water to the Domestic Hot Water Tank via Tube Connector. After 20~40min, water should flow out from Tap / Shower. Else, please contact your local authorized dealer.
- d. Check and make sure no water leaking at the tube connecting points.

- For Space Heating / Cooling
 - a. Turn the plug on the Air Purge Valve outlet anticlockwise by one complete turn from fully closed position.

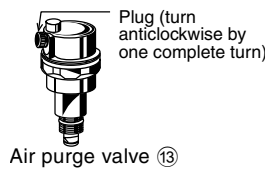

- b. Set the Pressure Relief Valve level "DOWN".

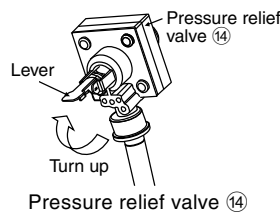

- c. Start filling water (with pressure more than 0.1 MPa (1 bar)) to the Space Heating / Cooling circuit via Tube Connector. Stop filling water if the free water flow through Pressure Relief Valve Drainage.
- d. Turn ON the Tank Unit and make sure Water Pump is running.
- e. Check and make sure no water leaking at the tube connecting points.

Discharge the Water

- For domestic hot water tank
 - a. Turn OFF power supply.
 - b. Set the Domestic Hot Water Tank Discharge Valve to "OPEN".
 - c. Open Tap / Shower to allow air inlet.
 - d. After discharge, set Hot Water Tank Discharge Valve to "CLOSE".

2 Check Water Pressure *(0.1 MPa = 1 bar)

Water pressure should not lower than 0.05 MPa (with inspects the Water Pressure Gauge). If necessary add water into Tank Unit (via Tube Connector).

3 Check Pressure Relief Valve

- Check for correct operation of Pressure Relief Valve by turning on the lever to become horizontal.
- If you do not hear a clacking sound (due to water drainage), contact your local authorized dealer.
- Push down the lever after finish checking.
- In case the water keep on draining out from the Tank Unit, switch off the system, and then contact your local authorized dealer.

4 Air Purge Valve

Air purge valve must be installed at all high points in a closed water circuit system.

An automatic air purge valve is provided inside the indoor unit. To automatically purge the air from the system, turn the plug on the air outlet anticlockwise by one complete turn from fully closed position.

Excessive air is automatically purged if the plug is kept in this position.

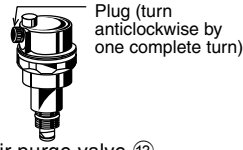

Air purge valve ⑬

5 Indoor Unit Control Board Area

Thorough visual inspection of the control board and look for defects, i.e. loose connection, melting of wire insulator and etc.

6 RCCB/ELCB

Ensure the RCCB/ELCB set to "ON" condition before check RCCB/ELCB.

Turn on the power supply to the indoor unit.

This testing could only be done when power is supplied to the indoor unit.



WARNING

Be careful not to touch parts other than RCCB/ELCB test button when the power is supplied to Indoor Unit. Else, electrical shock may happen.

- Push the "TEST" button on the RCCB/ELCB. The lever would turn down and indicate "0" and indicate green colour if it functions normal.
- Contact authorized dealer if the RCCB/ELCB malfunction.
- Turn off the power supply to the indoor unit.
- If RCCB/ELCB functions normal, set the lever to "ON" again after testing finish.

7 Reset Overload Protector

Overload Protector serves the safety purpose to prevent the water over heating. When the Overload Protector trip at high water temperature, take below steps to reset it.

- a. Take out the cover.
- b. Use a test pen to push the center button gently in order to reset the Overload Protector.
- c. Fix the cover to the original fixing condition.

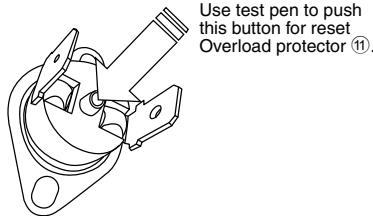

8 Maintenance for Water Filter Set

Clean the external water filter in regularly basic.

- a. Turn OFF power supply.
- b. Set the two valves for the Water Filter Set to "CLOSE".
- c. Take off the clip, then gently pull out the mesh. Beware of small amount water drain out from it.
- d. Clean the mesh with warm water to remove all the stain. Use soft brush if necessary.
- e. Reinstall the mesh to the Water Filter Set and set back the clip on it.
- f. Set the two valves for the Water Filter Set to "OPEN".
- g. Turn ON power supply.

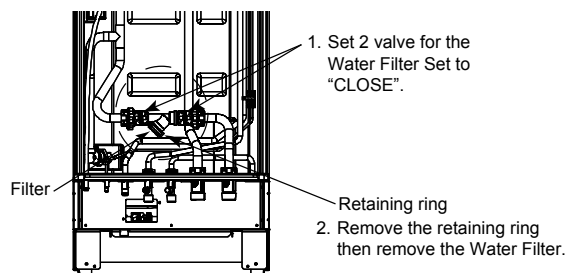

9 Maintenance for Anode Bar

To protect the tank body an anode bar is placed inside the tank. The Anode Bar will corrode, depending on the water quality. When diameter is approximate 8 mm the anode must be replaced. Examine it ONCE IN A YEAR.

- a. Turn off power supply.
- b. Close water supply valve.
- c. Manually open the Plugs (at Tube Connector © & ®) and drain approximate 2 litres.
- d. Take off the Top Plate with the 19 mounting screws. Be careful do not drop the Top Front Plate.
- e. Unscrew the Anode Bar (covered by insulator), check and if necessary replace.
 - o The Anode Bar can be removed to provide visual inspection access to the cylinder.

10 Maintenance for Pressure Relief Valve (Field Supply)

It is strongly recommended to operate the Pressure Relief Valve (field supply) regularly to ensure it is not blocked and remove lime deposits.

16.1 Maintenance for Water Filter Set

16.1.1 Service and maintenance

When connect CN-CNT connector with computer

Please use optional USB cable to connect with CN-CNT connector.
After connected, it requests for driver. If PC is under Windows Vista or later version, it automatically installs the driver under internet environment.

If PC uses Windows XP or earlier version and there is no internet access, please get FTDI Ltd's USB-RS232C conversion IC driver (VCP driver) and install.
<http://www.ftdichip.com/Drivers/VCP.htm>

If forget Password and cannot operate remote controller

Press + + for 5 sec.
Password unlock screen appears, press Confirm and it shall reset.
Password will become 0000. Please reset it again.
(CAUTION) Only display when it is locked by password.

16.1.2 Maintenance menu

Setting method of Maintenance menu

Maintenance menu	17:26, Wed
Actuator check	
Test mode	
Sensor setup	
Reset password	
▼ Select	[↵] Confirm

Press + + for 5 sec.

Items that can be set

- ① Actuator check (Manual ON/OFF all functional parts)
(CAUTION) As there is no protection action, please be careful not to cause any error when operating each part (do not turn on pump when there is no water etc.)
- ② Test mode (Test run)
Normally it is not used.
- ③ Sensor setup (offset gap of detected temp of each sensor within -2~2°C range)
(CAUTION) Please use only when sensor is deviated. It affects temperature control.
- ④ Reset password (Reset password)

16.1.3 Custom menu

Setting method of Custom menu

Custom menu	17:26, Wed
Cool mode	
Back-up heater	
Reset energy monitor	
▼ Select	[↵] Confirm

Please press + + for 10 sec.

Items that can be set

- ① Cool mode (Set With/Without Cooling function) Default is without
(CAUTION) As with/without Cool mode may affect electricity application, please be careful and do not simply change it.
In Cool mode, please be careful if piping is not insulated properly, dew may form on pipe and water may drip on the floor and damage the floor.
- ② Backup heater (Use/Do not use Backup heater)
(CAUTION) It is different from to use/not to use backup heater set by client. When this setting is used, heater power on due to protection against frost will be disabled. (Please use this setting when it is required by utility company.)
By using this setting, it cannot defrost due to low Heating's setting temp and operation may stop (H75)
Please set under the responsibility of installer. When it stops frequently, it may be due to insufficient circulation flow rate, setting temp of heating is too low etc.
- ③ Reset energy monitor (delete memory of Energy monitor)
Please use when moving house and handover the unit.

16.1.4 Specifications

16.1.4.1 *Specifications of fresh water as heat transfer medium in brazed heat exchanger*

Parameter	Quality Limits for Tap Water on the Secondary Side
Temperature	Below 60°C
pH	7 to 9
Alkalinity	60mg/l < HCO ₃ < 300mg/l
Conductivity	< 500µS/cm
Hardness	[Ca ⁺ , Mg ⁺] / [HCO ₃ ⁻] > 0.5
Chloride	< 200mg/l at 60°C
Sulphate	[SO ₄ ²⁻] < 100mg/l and [HCO ₃ ⁻] / [SO ₄ ²⁻] > 1
Nitrate	NO ₃ < 100mg/l
Chlorine	< 0.5mg/l

16.1.4.2 *External filter*

Solids in the water must be filtered.

Minimum filter mesh size required for the field supply external filter in the water inlet is 20 mesh.

17. Troubleshooting Guide

17.1 Refrigeration Cycle System

In order to diagnose malfunctions, make sure that there are no electrical problems before inspecting the refrigeration cycle.

Such problems include insufficient insulation, problem with the power source, malfunction of a compressor and a fan.

The normal pressure of the refrigeration cycle depends on various conditions, the standard values for them are shown in the table on the right.

Normal Pressure (Standard)

	Gas pressure MPa (kg/cm ² G)
Heating Mode	2.3 ~ 2.9 (23 ~ 29)
Cooling Mode	0.9 ~ 1.2 (9 ~ 12)

- ★ Condition:
- Outdoor temperature 7°C at heating mode and 35°C at cooling mode.
 - Compressor operates at rated frequency.

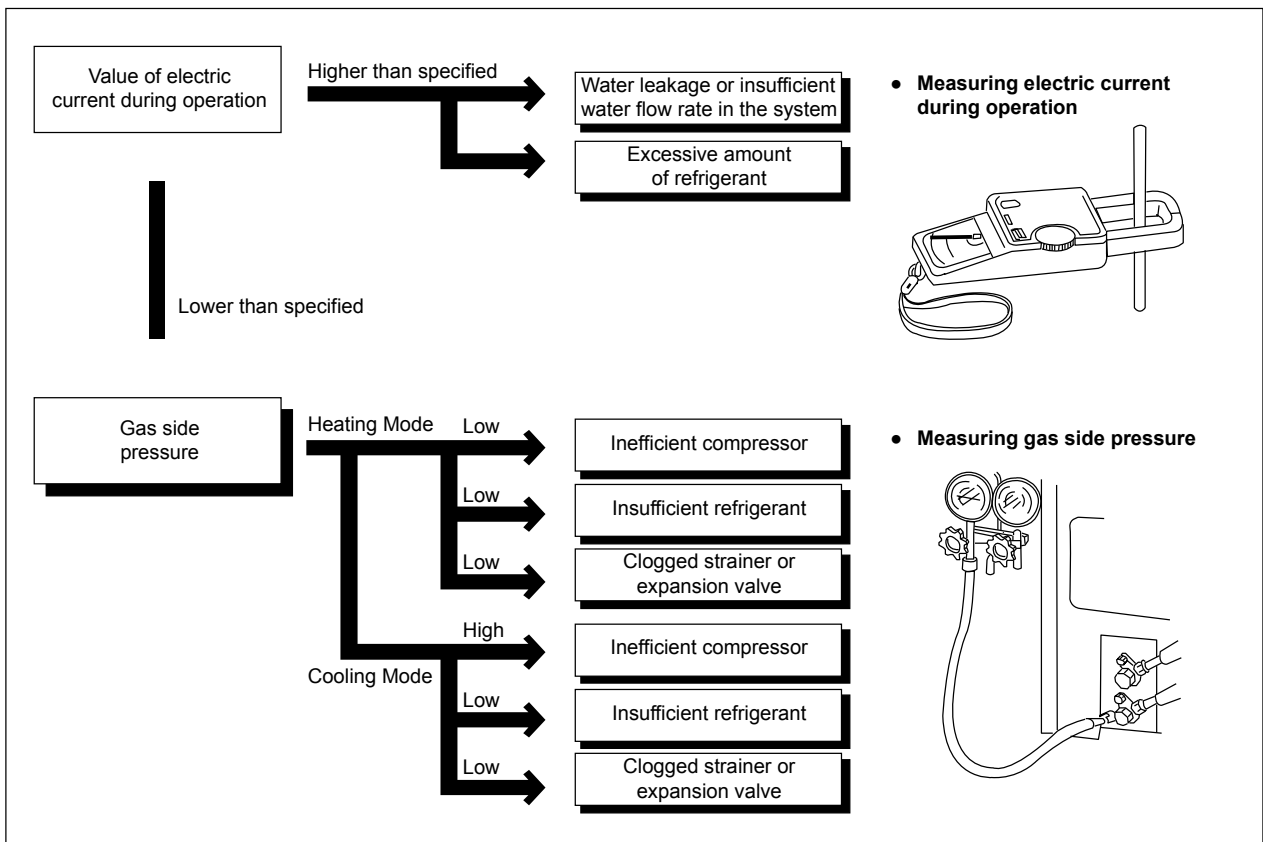

17.2 Relationship between the Condition of the Air-to-Water Hydromodule + Tank and Air-to-Water Heatpump Outdoor Units and Pressure and Electric Current

Condition of the Air-to-Water Hydromodule + Tank and Air-to-Water Heatpump outdoor units	Heating Mode			Cooling Mode		
	Low Pressure	High Pressure	Electric current during operation	Low Pressure	High Pressure	Electric current during operation
Water leakage or insufficient water flow rate in the system						
Excessive amount of refrigerant						
Inefficient compression						
Insufficient refrigerant (gas leakage)						
Outdoor heat exchange deficiency						
Clogged expansion valve or Strainer						

- Carry out the measurements of pressure, electric current, and temperature fifteen minutes after an operation is started.

17.3 Breakdown Self Diagnosis Function

17.3.1 Self Diagnosis Function (Three Digits Alphanumeric Code)

- When abnormality occur during operation, the system will stop operation, and OFF/ON control panel LED will blink and error code will display on the control panel.
- Even error code is reset by turning OFF power supply or by selecting ERROR RESET, if the system abnormality is still unrepaired, system will again stop operation, and OFF/ON control panel LED will again blinks and error code will be display.
- The error code will store in IC memory.
- **To check the error code**
 - 1 When an abnormality occurs, system will stop operation and OFF/ON control panel LED will blink.
 - 2 Error code of the abnormality will be display on the control panel.
 - 3 To determine the abnormality description, the error code table needs to be referred.

eg:

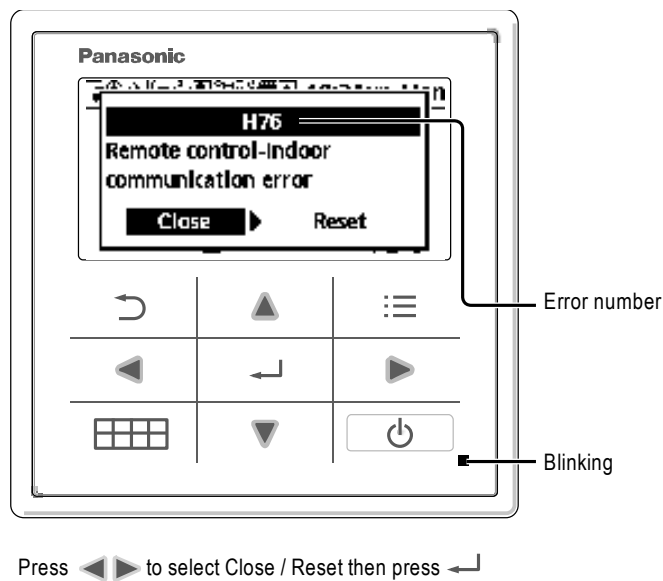

- **To display past/last error code**
 - 1 Turn ON power supply.
 - 2 Refer below procedure to retrieve the error code history.
- **To permanently delete error code from IC memory**
 - 1 Turn ON power supply.
 - 2 Refer below procedure to clear error history.

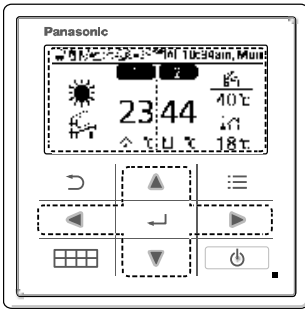

Press button and select "System Check"

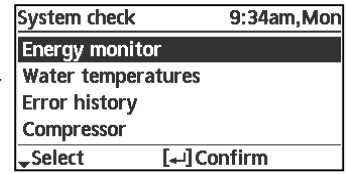
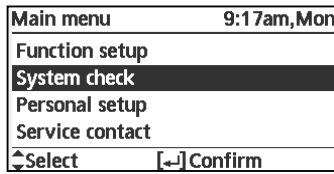

Press SW to select "Error history"

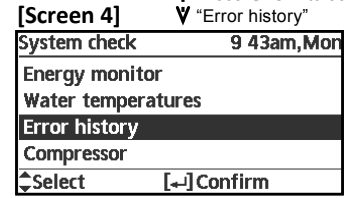

Display last 4 error retrieved from EEPROM

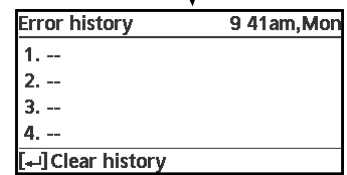
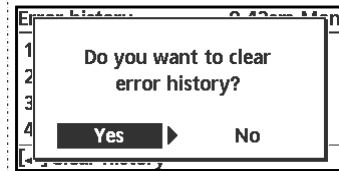
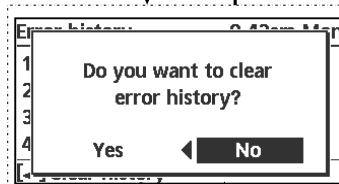
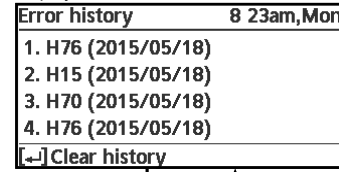

17.4 Error Codes Table

Diagnosis display	Abnormality/Protection control	Abnormality judgement	Primary location to verify
H00	No abnormality detected	—	—
H12	Indoor/Outdoor capacity unmatched	90s after power supply	<ul style="list-style-type: none"> Indoor/outdoor connection wire Indoor/outdoor PCB Specification and combination table in catalogue
H15	Outdoor compressor temperature sensor abnormality	Continue for 5 sec.	<ul style="list-style-type: none"> Compressor temperature sensor (defective or disconnected)
H20	Water pump abnormality	Continue for 10 sec.	<ul style="list-style-type: none"> Indoor PCB Water pump (malfunction)
H23	Indoor refrigerant liquid temperature sensor abnormality	Continue for 5 sec.	<ul style="list-style-type: none"> Refrigerant liquid temperature sensor (defective or disconnected)
H27	Service valve error	Continue for 5 minutes	<ul style="list-style-type: none"> High pressure sensor (defective or disconnected)
H28	Abnormal solar sensor	Continue for 5 sec.	<ul style="list-style-type: none"> Solar temperature sensor (defective or disconnected)
H31	Abnormal swimming pool sensor	Continue for 5 sec.	<ul style="list-style-type: none"> Pool temperature sensor (defective or disconnected)
H36	Abnormal buffer tank sensor	Continue for 5 sec.	<ul style="list-style-type: none"> Buffer tank sensor (defective or disconnected)
H38	Brand code not match	When indoor and outdoor brand code not same	—
H42	Compressor low pressure abnormality	—	<ul style="list-style-type: none"> Outdoor pipe temperature sensor Clogged expansion valve or strainer Insufficient refrigerant Outdoor PCB Compressor
H43	Abnormal Zone 1 sensor	Continue for 5 sec.	<ul style="list-style-type: none"> Water temperature Zone 1 sensor
H44	Abnormal Zone 2 sensor	Continue for 5 sec.	<ul style="list-style-type: none"> Water temperature Zone 2 sensor
H62	Water flow switch abnormality	Continue for 1 min.	<ul style="list-style-type: none"> Water flow switch
*H63	Refrigerant low pressure abnormality	Continue for 5 sec.	<ul style="list-style-type: none"> Outdoor low pressure sensor (defective or disconnected)
H64	Refrigerant high pressure abnormality	Continue for 5 sec.	<ul style="list-style-type: none"> Outdoor high pressure sensor (defective or disconnected)
*H65	Deice circulation error	Continue for 10 sec.	<ul style="list-style-type: none"> Water flow switch sensor (defective or disconnected) Water pump malfunction Buffer tank (is used)
H67	Abnormal External Thermistor 1	Continue for 5 sec.	<ul style="list-style-type: none"> Room temperature Zone 1 sensor
H68	Abnormal External Thermistor 2	Continue for 5 sec.	<ul style="list-style-type: none"> Room temperature Zone 2 sensor
H70	Back-up heater OLP abnormality	Continue for 60 sec.	<ul style="list-style-type: none"> Back-up heater OLP (Disconnection or activated)
H72	Tank sensor abnormal	Continue for 5 sec.	<ul style="list-style-type: none"> Tank sensor
H74	PCB communication error	Communication or transfer error	<ul style="list-style-type: none"> Indoor main PCB and Sub PCB
H75	Low water temperature control	Room heater disable and deice request to operate under low water temperature	<ul style="list-style-type: none"> Heater operation must enable to increase water temperature
H76	Indoor - control panel communication abnormality	—	<ul style="list-style-type: none"> Indoor - control panel (defective or disconnected)
H90	Indoor/outdoor abnormal communication	> 1 min after starting operation	<ul style="list-style-type: none"> Internal/external cable connections Indoor/Outdoor PCB
H91	Tank heater OLP abnormality	Continue for 60 sec.	<ul style="list-style-type: none"> Tank heater OLP (Disconnection or activated)
H95	Indoor/Outdoor wrong connection	—	<ul style="list-style-type: none"> Indoor/Outdoor supply voltage
H98	Outdoor high pressure overload protection	—	<ul style="list-style-type: none"> Outdoor high pressure sensor Water pump or water leakage Clogged expansion valve or strainer Excess refrigerant Outdoor PCB
H99	Indoor heat exchanger freeze prevention	—	<ul style="list-style-type: none"> Indoor heat exchanger Refrigerant shortage
F12	Pressure switch activate	4 times occurrence within 20 minutes	<ul style="list-style-type: none"> Pressure switch
F14	Outdoor compressor abnormal revolution	4 times occurrence within 20 minutes	<ul style="list-style-type: none"> Outdoor compressor
F15	Outdoor fan motor lock abnormality	2 times occurrence within 30 minutes	<ul style="list-style-type: none"> Outdoor PCB Outdoor fan motor
F16	Total running current protection	3 times occurrence within 20 minutes	<ul style="list-style-type: none"> Excess refrigerant Outdoor PCB

Diagnosis display	Abnormality/Protection control	Abnormality judgement	Primary location to verify
F20	Outdoor compressor overheating protection	4 times occurrence within 30 minutes	<ul style="list-style-type: none"> Compressor tank temperature sensor Clogged expansion valve or strainer Insufficient refrigerant Outdoor PCB Compressor
F22	IPM (power transistor) overheating protection	3 times occurrence within 30 minutes	<ul style="list-style-type: none"> Improper heat exchange IPM (Power transistor)
F23	Outdoor Direct Current (DC) peak detection	7 times occurrence continuously	<ul style="list-style-type: none"> Outdoor PCB Compressor
F24	Refrigeration cycle abnormality	2 times occurrence within 20 minutes	<ul style="list-style-type: none"> Insufficient refrigerant Outdoor PCB Compressor low compression
F25	Cooling/Heating cycle changeover abnormality	4 times occurrence within 30 minutes	<ul style="list-style-type: none"> 4-way valve V-coil
F27	Pressure switch abnormality	Continue for 1 min.	<ul style="list-style-type: none"> Pressure switch
F29	Low Discharge Superheat	1 times occurrence within 2550 minutes	<ul style="list-style-type: none"> Discharge Temperature Sensor Discharge Pressure Sensor Pressure Switch Outdoor PCB
F30	Water outlet sensor 2 abnormality	Continue for 5 sec.	<ul style="list-style-type: none"> Water outlet sensor 2 (defective or disconnected)
F32	Abnormal Internal Thermostat	Continue for 5 sec.	<ul style="list-style-type: none"> Control panel PCB thermostat
F36	Outdoor air temperature sensor abnormality	Continue for 5 sec.	<ul style="list-style-type: none"> Outdoor air temperature sensor (defective or disconnected)
F37	Indoor water inlet temperature sensor abnormality	Continue for 5 sec.	<ul style="list-style-type: none"> Water inlet temperature sensor (defective or disconnected)
F40	Outdoor discharge pipe temperature sensor abnormality	Continue for 5 sec.	<ul style="list-style-type: none"> Outdoor discharge pipe temperature sensor (defective or disconnected)
F41	PFC control	4 times occurrence within 10 minutes	<ul style="list-style-type: none"> Voltage at PFC
F42	Outdoor heat exchanger temperature sensor abnormality	Continue for 5 sec.	<ul style="list-style-type: none"> Outdoor heat exchanger temperature sensor (defective or disconnected)
F43	Outdoor defrost sensor abnormality	Continue for 5 sec.	<ul style="list-style-type: none"> Outdoor defrost sensor (defective or disconnected)
F45	Indoor water outlet temperature sensor abnormality	Continue for 5 sec.	<ul style="list-style-type: none"> Water outlet temperature sensor (defective or disconnected)
F46	Outdoor Current Transformer open circuit	—	<ul style="list-style-type: none"> Insufficient refrigerant Outdoor PCB Compressor low
F48	Outdoor EVA outlet temperature sensor abnormality	Continue for 5 sec.	<ul style="list-style-type: none"> Outdoor EVA outlet temperature sensor (defective or disconnected)
F49	Outdoor bypass outlet temperature sensor abnormality	Continue for 5 sec.	<ul style="list-style-type: none"> Outdoor bypass outlet temperature sensor (defective or disconnected)
F95	Cooling high pressure overload protection	—	<ul style="list-style-type: none"> Outdoor high pressure sensor Water pump or water leakage Clogged expansion valve or strainer Excess refrigerant Outdoor PCB

Note: * This error code is not applicable for this system.

17.5 Self-diagnosis Method

17.5.1 Connection Capability Rank Abnormality (H12)

Malfunction Decision Conditions:

During startup operation of cooling and heating, the capability rank of indoor checked by the outdoor is used to determine connection capability rank abnormality.

Malfunction Caused:

- 1 Wrong model interconnected.
- 2 Wrong indoor unit or outdoor unit PCB (main) used.
- 3 Faulty indoor unit or outdoor unit PCB (main).

Abnormality Judgment:

Continue for 90 seconds.

Troubleshooting:

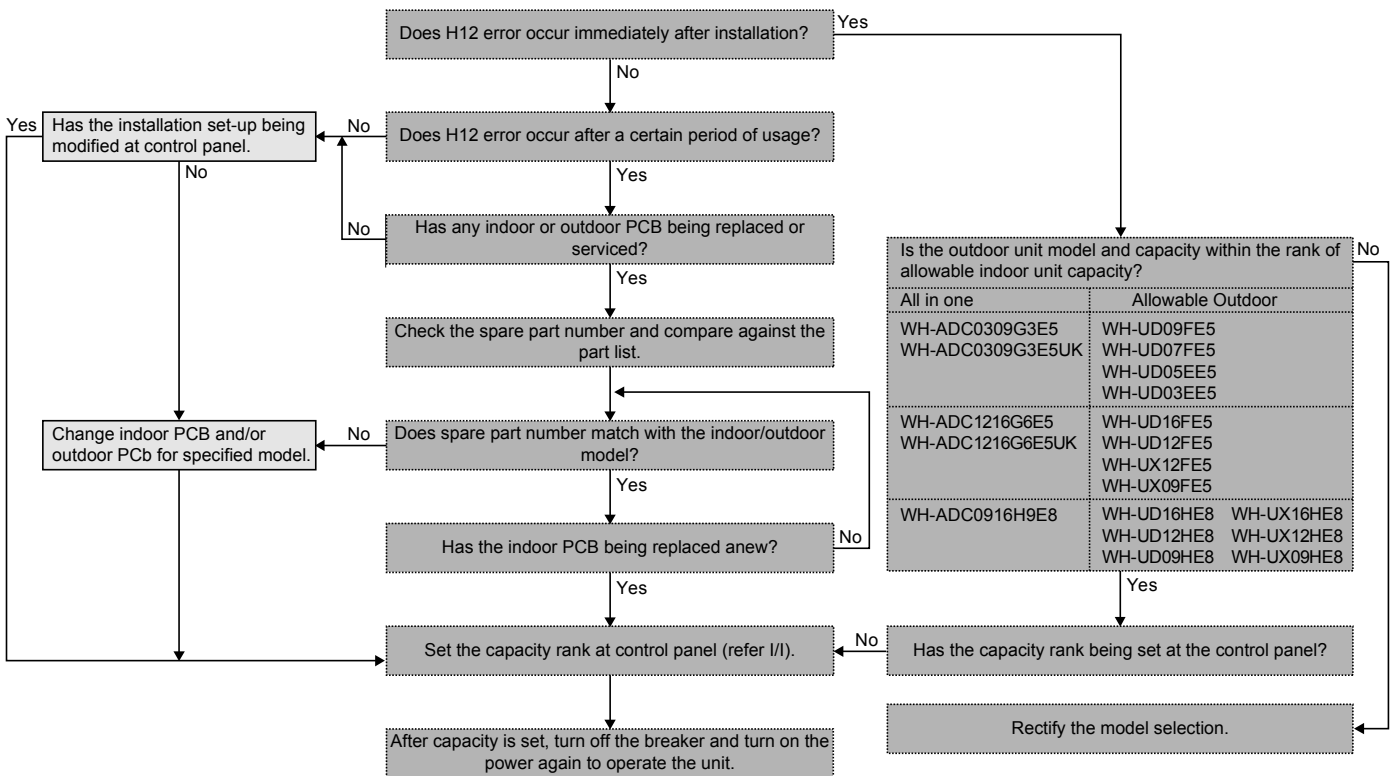

17.5.2 Compressor Tank Temperature Sensor Abnormality (H15)

Malfunction Decision Conditions:

During startup and operation of cooling and heating, the temperatures detected by the compressor tank temperature sensor are used to determine sensor error.

Malfunction Caused:

- 1 Faulty connector connection.
- 2 Faulty sensor.
- 3 Faulty outdoor unit PCB (main).

Abnormality Judgment:

Continue for 5 seconds.

Troubleshooting:

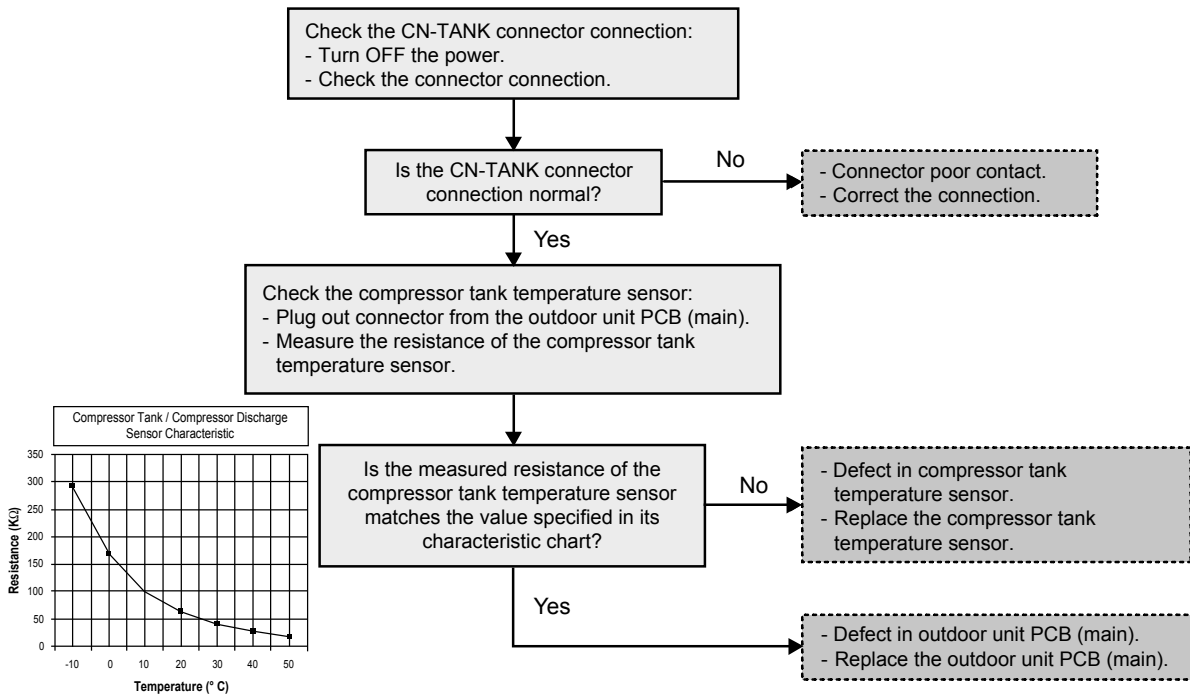

17.5.3 Water Pump Abnormality (H20)

Malfunction Decision Conditions:

During startup and operation of cooling and heating, the rotation speed detected by the IPM of water pump motor during water pump operation is used to determine abnormal water pump (feedback of rotation > 6,000rpm or < 1,000rpm).

Malfunction Caused:

- 1 Operation stop due to short circuit inside the water pump motor winding.
- 2 Operation stop due to breaking of wire inside the water pump motor.
- 3 Operation stop due to breaking of water pump lead wires.
- 4 Operation stop due to water pump motor IPM malfunction.
- 5 Operation error due to faulty indoor unit PCB.

Abnormality Judgment:

Continue for 5 seconds.

Troubleshooting:



Caution

For safety reason and to prevent component breakdown, always switch off the power before remove and connect the component.

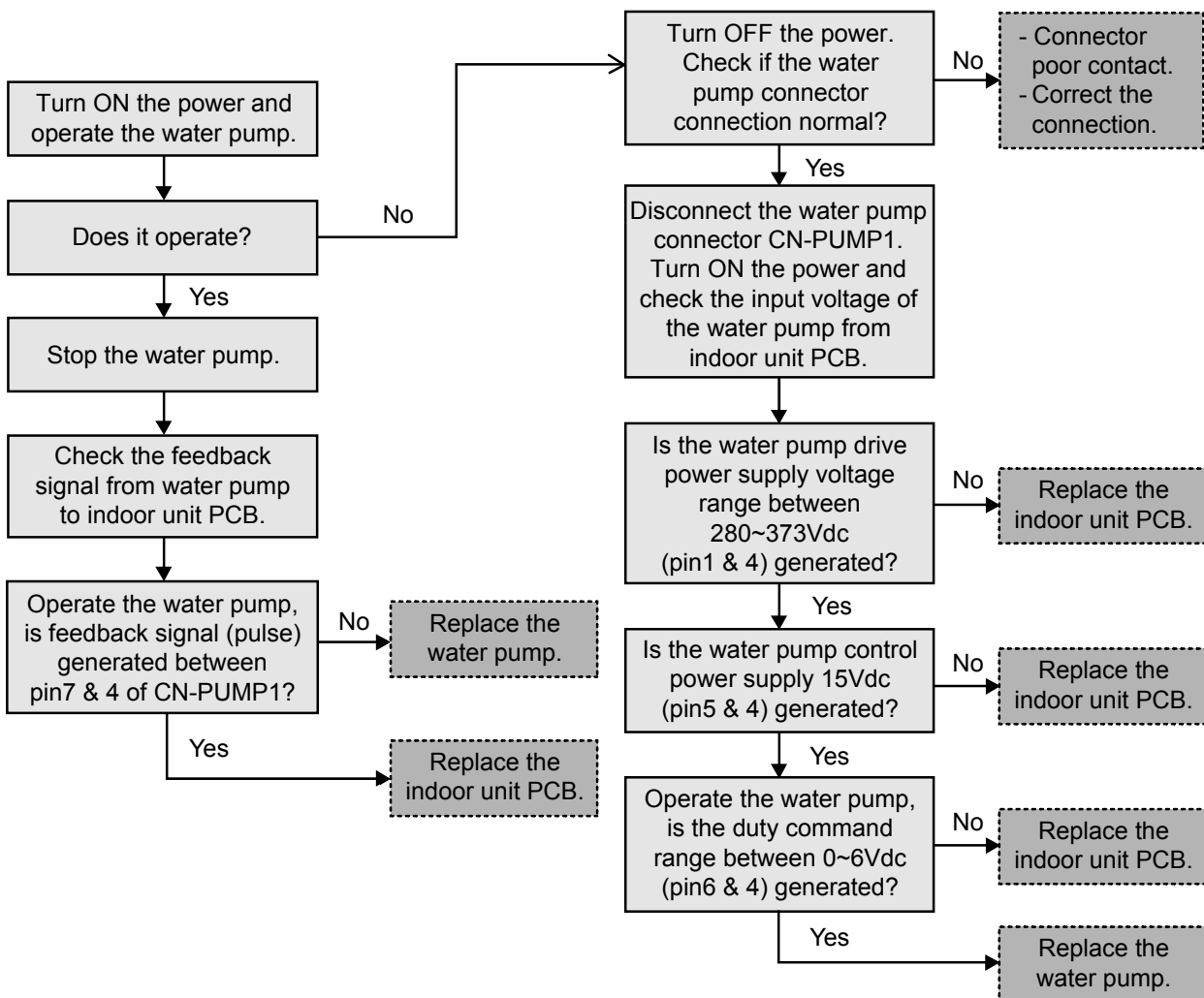

17.5.4 Indoor Refrigerant Liquid Temperature Sensor Abnormality (H23)

Malfunction Decision Conditions:

During startup and operation of cooling and heating, the temperatures detected by the indoor refrigerant liquid temperature sensor are used to determine sensor error.

Malfunction Caused:

- 1 Faulty connector connection.
- 2 Faulty sensor.
- 3 Faulty indoor unit PCB (main).

Abnormality Judgment:

Continue for 5 seconds.

Troubleshooting:



Caution

For safety reason and to prevent component breakdown, always switch off the power before remove and connect the component.

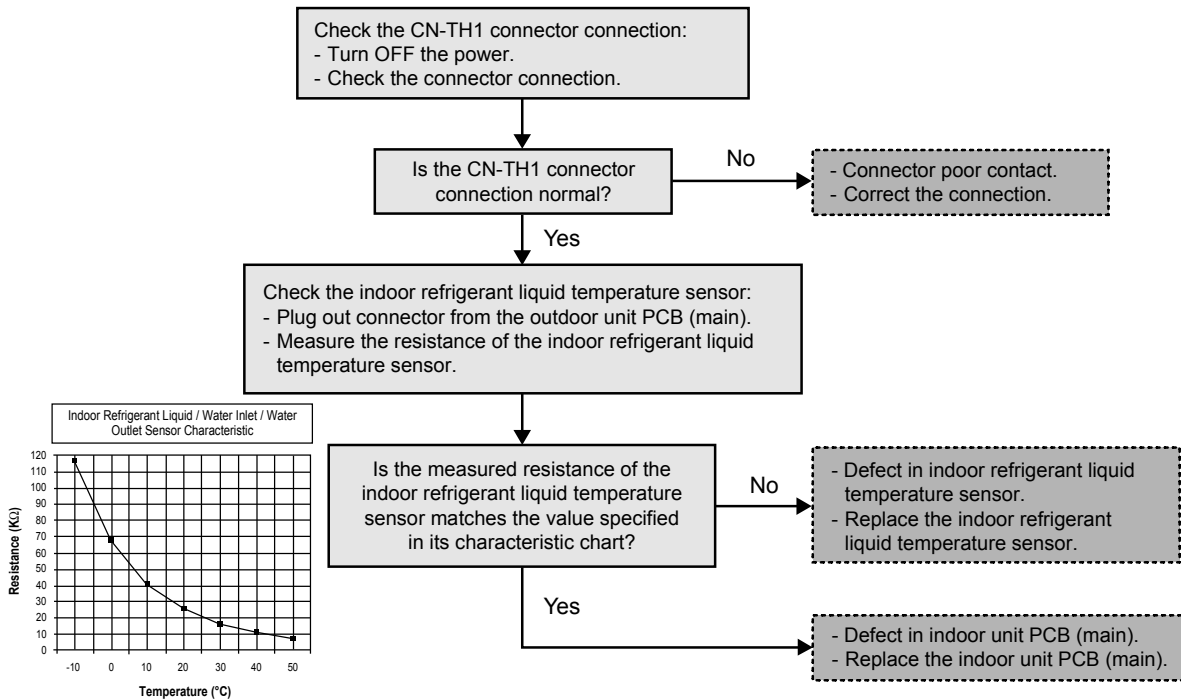

17.5.5 Service Valve Error (H27)

Malfunction Decision Conditions:

During cooling operation, when:-

[a] Indoor refrigerant pipe temperature at compressor startup - present indoor refrigerant pipe temperature < 2°C

[b] Present high pressure - high pressure at compressor startup < 5kg/cm²

**Judgment only for first time cooling operation and not during pump down operation.

Malfunction Caused:

- 1 3 way valves closed.
- 2 Faulty high pressure sensor.
- 3 Faulty indoor refrigerant pipe temperature sensor
- 4 Faulty outdoor unit PCB (main).

Abnormality Judgment:

Continue for 5 minutes.

Troubleshooting:



Caution

For safety reason and to prevent component breakdown, always switch off the power before remove and connect the component.

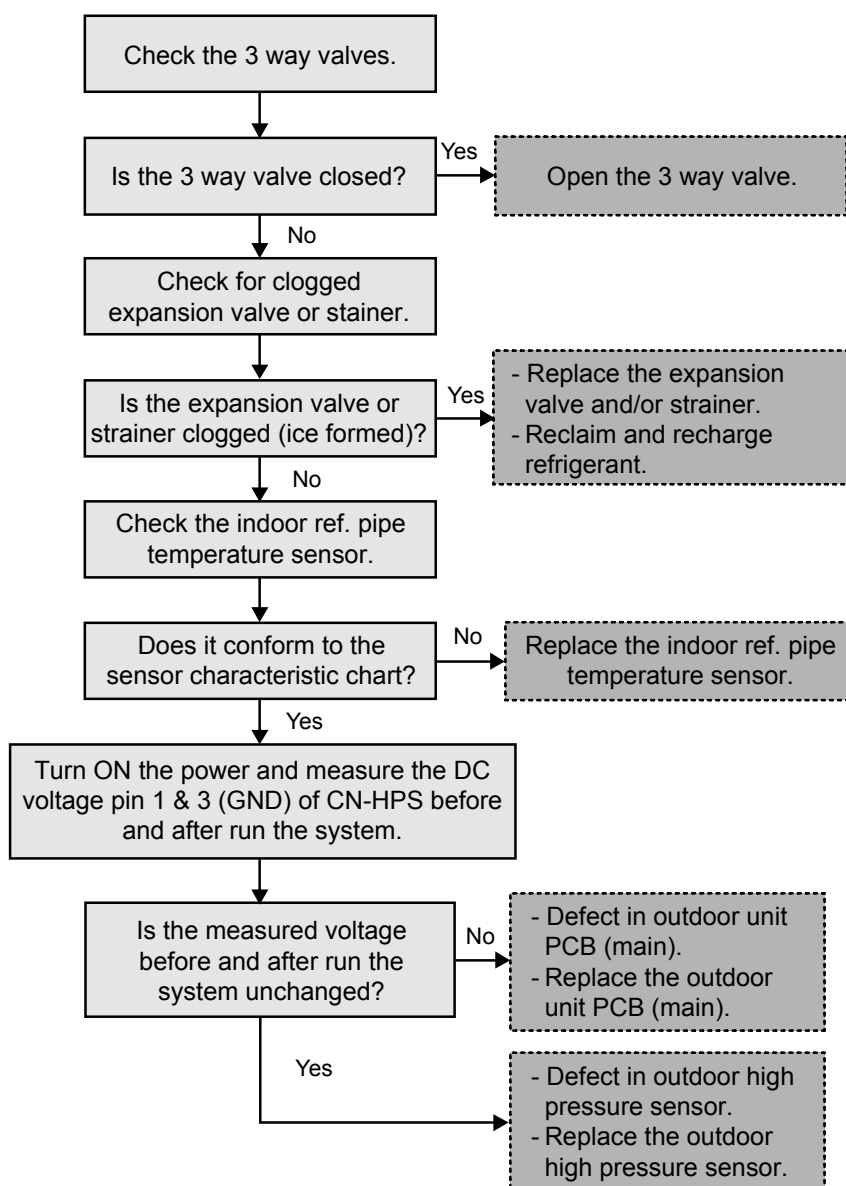

17.5.6 Abnormal Solar Sensor (H28)

Malfunction Caused:

- 1 Faulty connector connection.
- 2 Faulty solar sensor.
- 3 Faulty indoor sub PCB.

Abnormality Judgment:

Continue for 5 seconds.

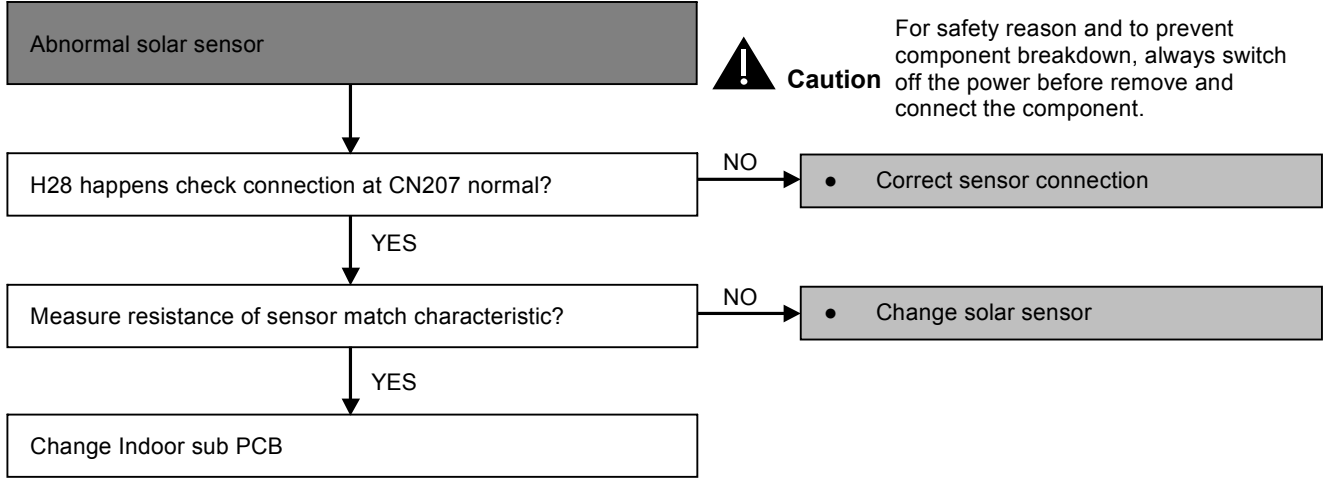

17.5.7 Abnormal Swimming Pool Sensor (H31)

Malfunction Caused:

- 1 Faulty connector connection.
- 2 Faulty swimming pool sensor.
- 3 Faulty indoor sub PCB.

Abnormality Judgment:

Continue for 5 seconds.

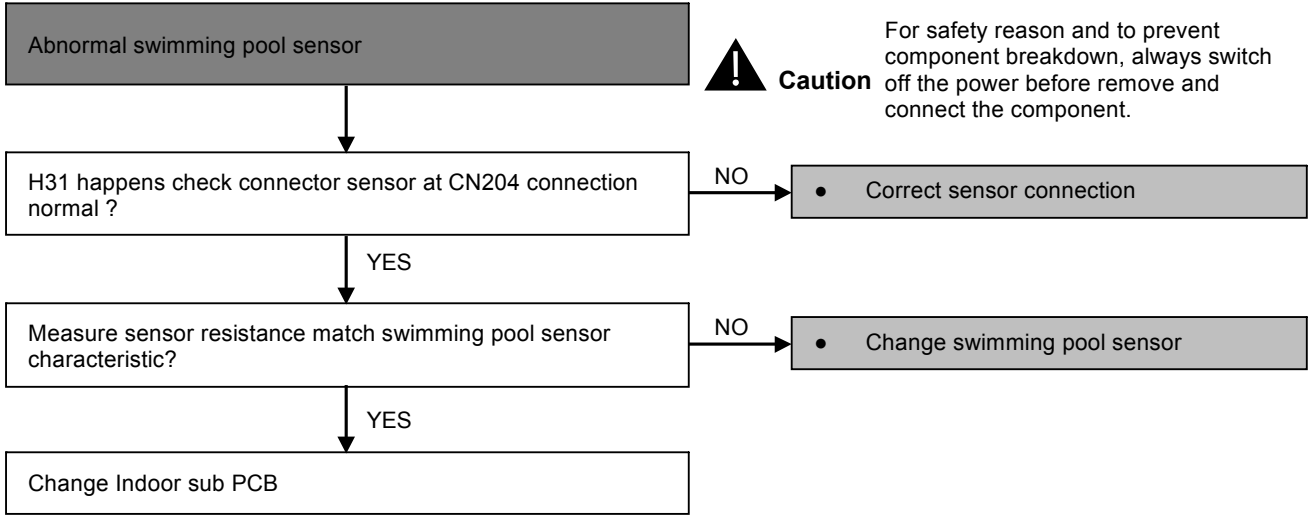

17.5.8 Abnormal Buffer Tank Sensor (H36)

Malfunction Caused:

- 1 Faulty connector connection.
- 2 Faulty buffer tank sensor.
- 3 Faulty indoor sub PCB.

Abnormality Judgment:

Continue for 5 seconds.

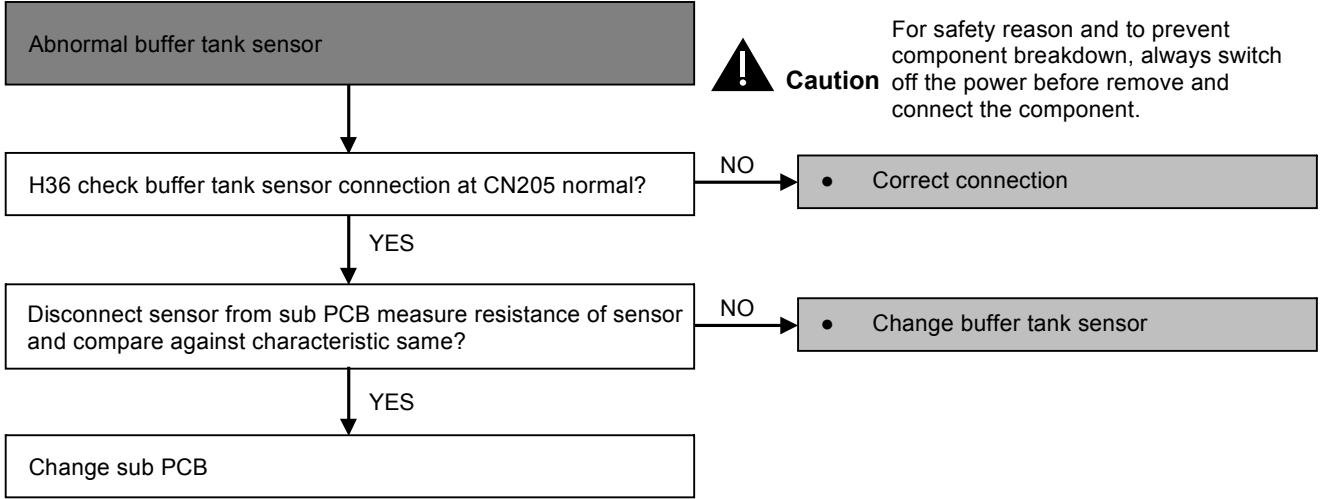

17.5.9 Brand Code Not Matching (H38)

Malfunction Caused:

- 1 Indoor and outdoor brand code not match.

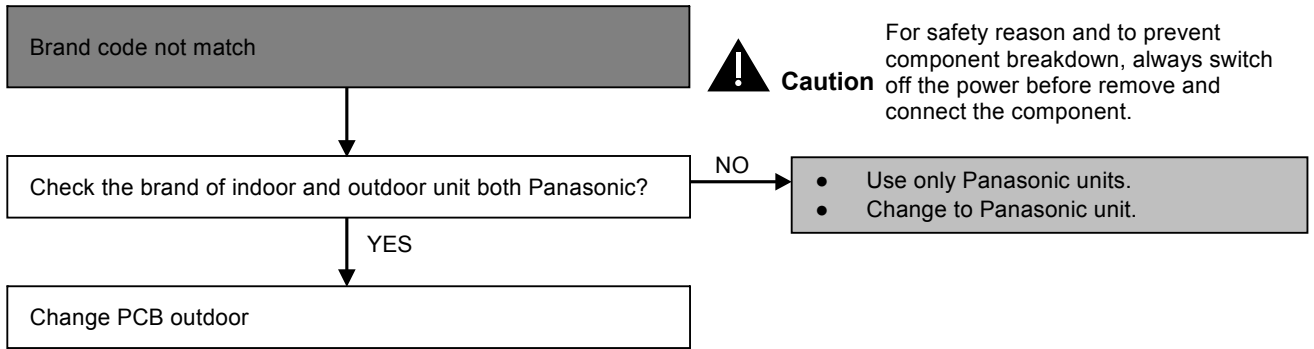

Caution

For safety reason and to prevent component breakdown, always switch off the power before remove and connect the component.

17.5.10 Compressor Low Pressure Protection (H42)

Malfunction Decision Conditions:

During operation of heating and after 5 minutes compressor ON, when outdoor pipe temperature below -29°C or above 26°C is detected by the outdoor pipe temperature sensor.

Malfunction Caused:

- 1 Dust accumulation on the outdoor unit heat exchanger.
- 2 Air short circuit at outdoor unit.
- 3 2 way valve partially closed.
- 4 Faulty outdoor unit fan motor.
- 5 Refrigerant shortage (refrigerant leakage).
- 6 Clogged expansion valve or strainer.
- 7 Faulty outdoor pipe temperature sensor.
- 8 Faulty outdoor unit main PCB (main).

Troubleshooting:



Caution

For safety reason and to prevent component breakdown, always switch off the power before remove and connect the component.

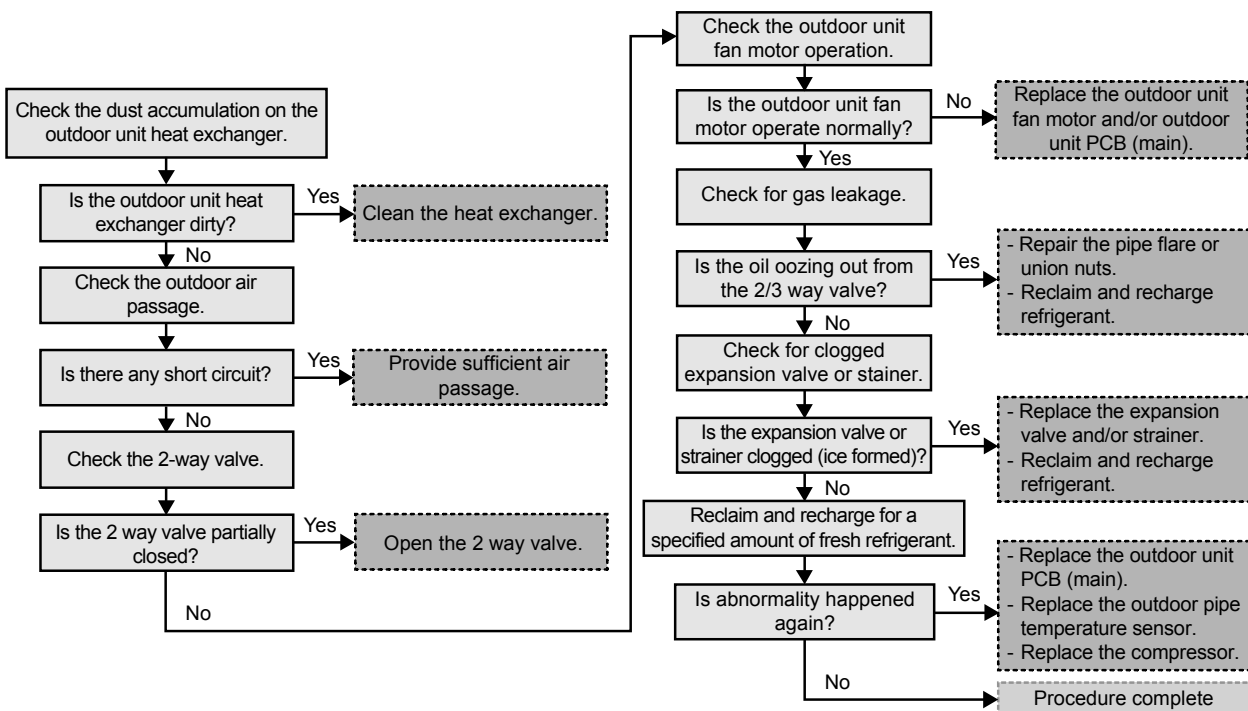

17.5.11 Abnormal Zone 1 Sensor (H43)

Malfunction Caused:

- 1 Faulty connector connection.
- 2 Faulty buffer tank sensor.
- 3 Faulty indoor sub PCB.

Abnormality Judgment:

Continue for 5 seconds.

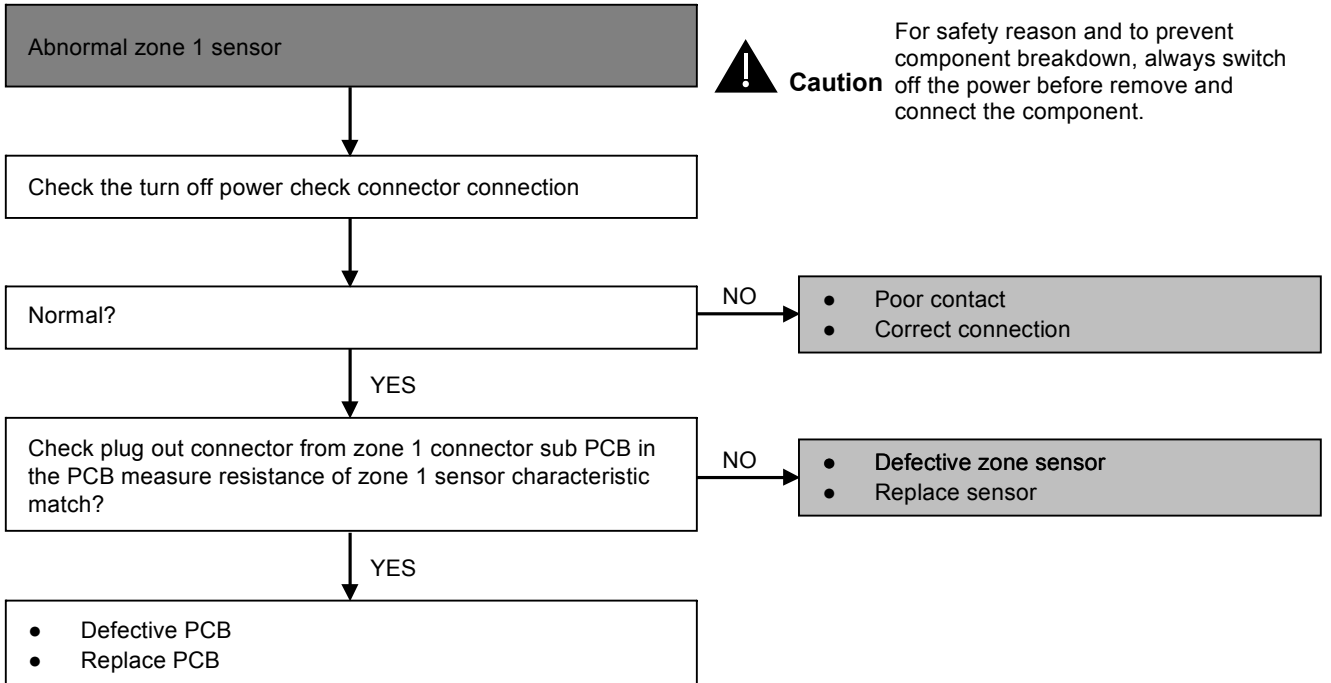

17.5.12 Abnormal Zone 2 Sensor (H44)

Malfunction Caused:

- 1 Faulty connector connection.
- 2 Faulty buffer tank sensor.
- 3 Faulty indoor sub PCB.

Abnormality Judgment:

Continue for 5 seconds.

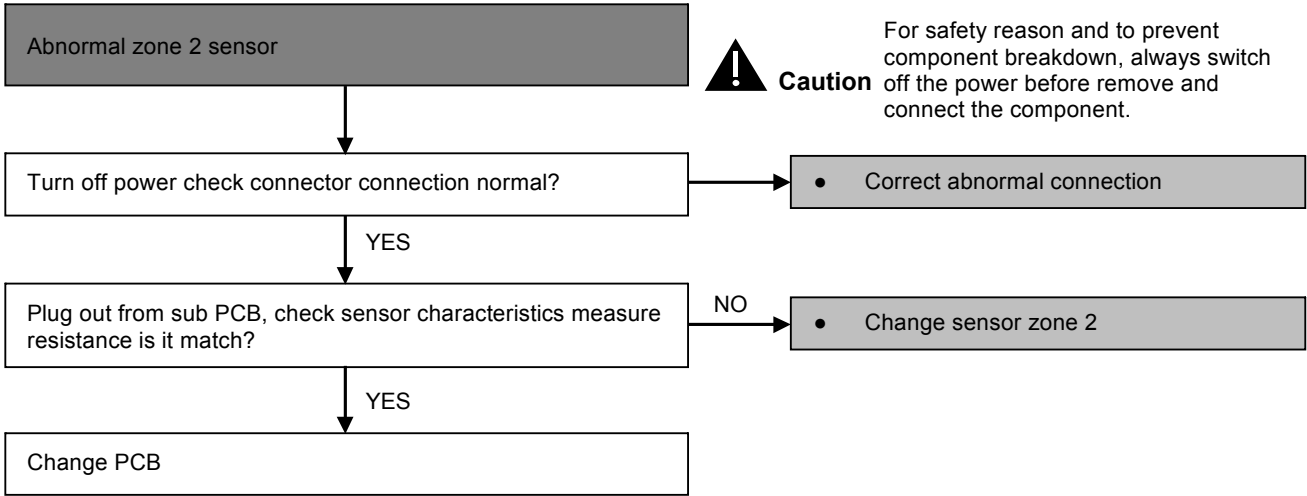

17.5.13 Water Flow Switch Abnormality (H62)

Malfunction Decision Conditions:

During operation of cooling and heating, the water flow detected by the indoor water flow switch is used to determine water flow error.

Malfunction Caused:

- 1 Faulty water pump.
- 2 Water leak in system.
- 3 Faulty connector connection.
- 4 Faulty water flow switch.
- 5 Faulty indoor unit PCB (main).

Abnormality Judgment:

Continue for 10 seconds (but no judgment for 9 minutes after compressor startup/restart).

Troubleshooting:



Caution

For safety reason and to prevent component breakdown, always switch off the power before remove and connect the component.

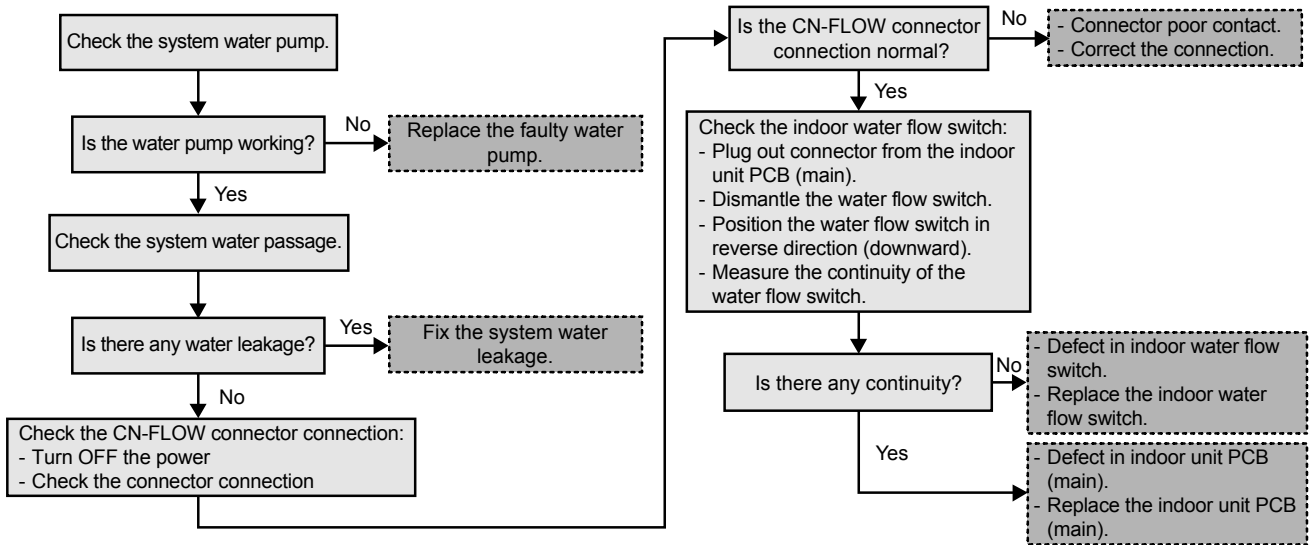

17.5.14 Outdoor High Pressure Abnormality (H64)

Malfunction Decision Conditions:

During operation of cooling and heating, when the outdoor high pressure sensor output signal is 0 Vdc or 5 Vdc.

Malfunction Caused:

- 1 Faulty connector connection.
- 2 Faulty sensor.
- 3 Faulty outdoor unit PCB (main).

Abnormality Judgment:

Continue 4 times in 20 minutes.

Troubleshooting:



Caution

For safety reason and to prevent component breakdown, always switch off the power before remove and connect the component.

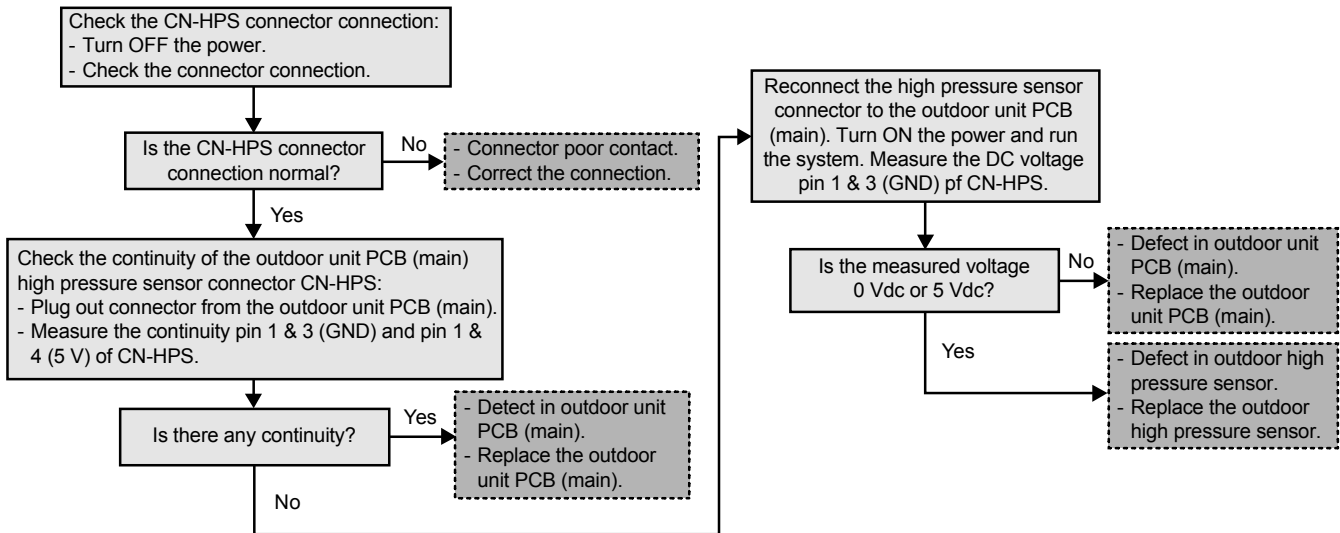

17.5.15 Deice Circulation Error (H65)

Malfunction Decision Conditions:

During startup and operation of deice (mode 2), the water flow (> 10l/min) detected by the water flow switch is used to determine deice circulation error.

Malfunction Caused:

- 1 Water flow in air-to-water heatpump indoor unit circuitry.
- 2 Faulty indoor unit water flow switch.
- 3 Faulty indoor unit water pump.
- 4 Faulty indoor unit PCB.

Abnormality Judgment:

Continue for 10 seconds.

Troubleshooting:



Caution

For safety reason and to prevent component breakdown, always switch off the power before remove and connect the component.

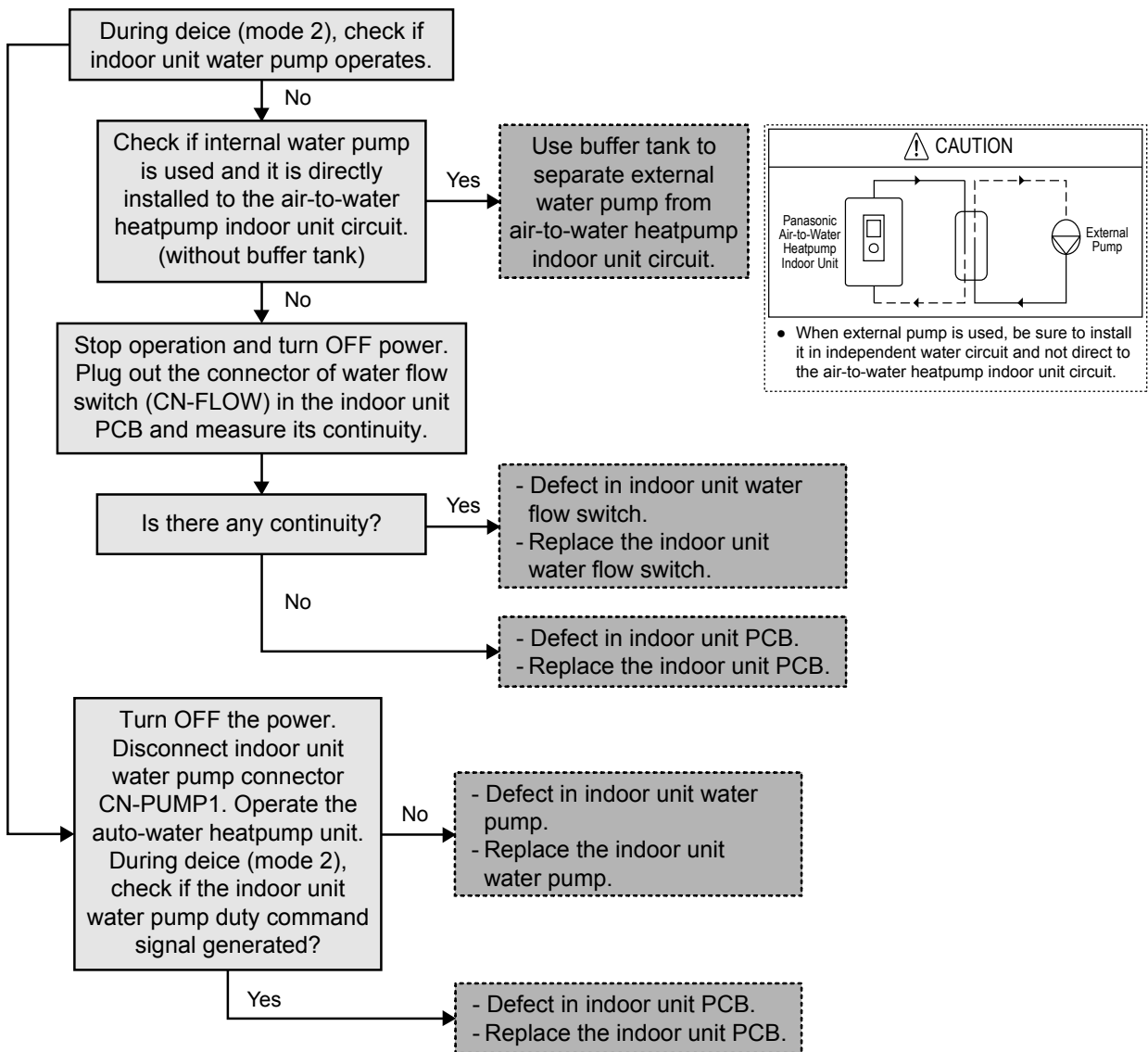

17.5.16 Abnormal External Thermistor 1 (H67)

Malfunction Caused:

- 1 Faulty connector connection.
- 2 Faulty room temperature zone 1 sensor.
- 3 Faulty indoor sub PCB.

Abnormality Judgment:

Continue for 5 seconds.

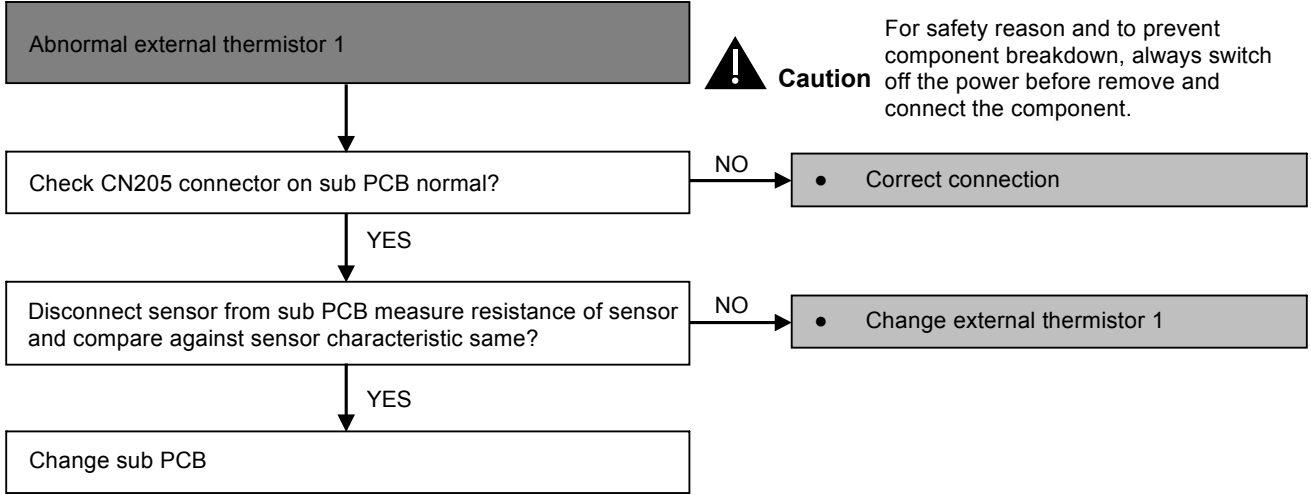

17.5.17 Abnormal External Thermistor 2 (H68)

Malfunction Caused:

- 1 Faulty connector connection.
- 2 Faulty room temperature zone 2 sensor.
- 3 Faulty indoor sub PCB.

Abnormality Judgment:

Continue for 5 seconds.

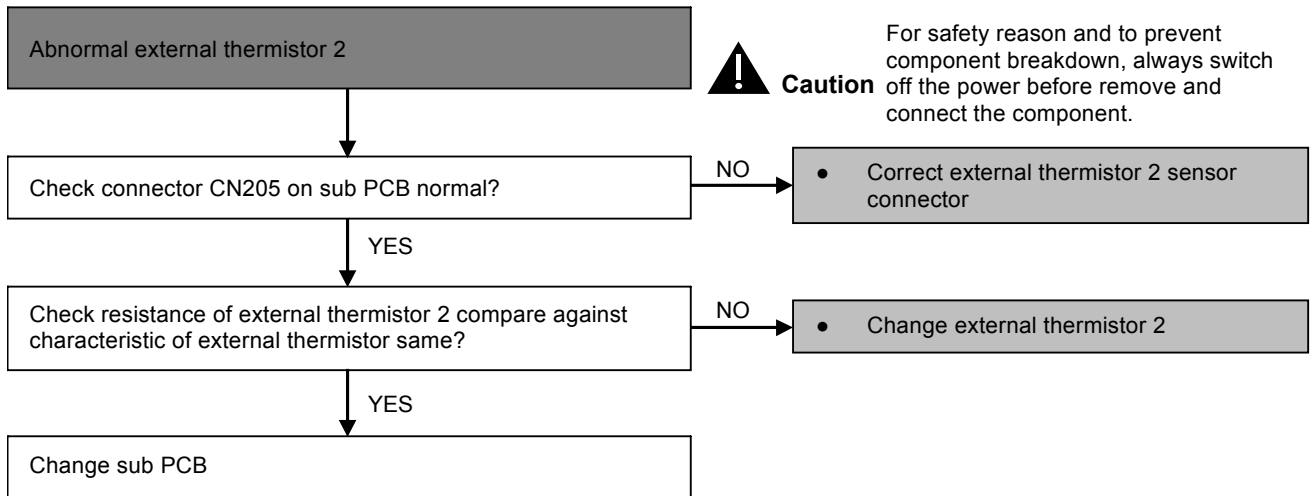

17.5.18 Indoor Backup Heater OLP Abnormality (H70)

Malfunction Decision Conditions:

During operation of indoor backup heater, when no power supplies to indoor backup heater or OLP open circuit.

Malfunction Caused:

- 1 Faulty power supply connector connection.
- 2 Faulty connector connection.
- 3 Faulty indoor backup heater overload protector (OLP).
- 4 Faulty indoor unit PCB (main).

Abnormality Judgment:

Continue for 60 seconds.

Troubleshooting:



Caution

For safety reason and to prevent component breakdown, always switch off the power before remove and connect the component.

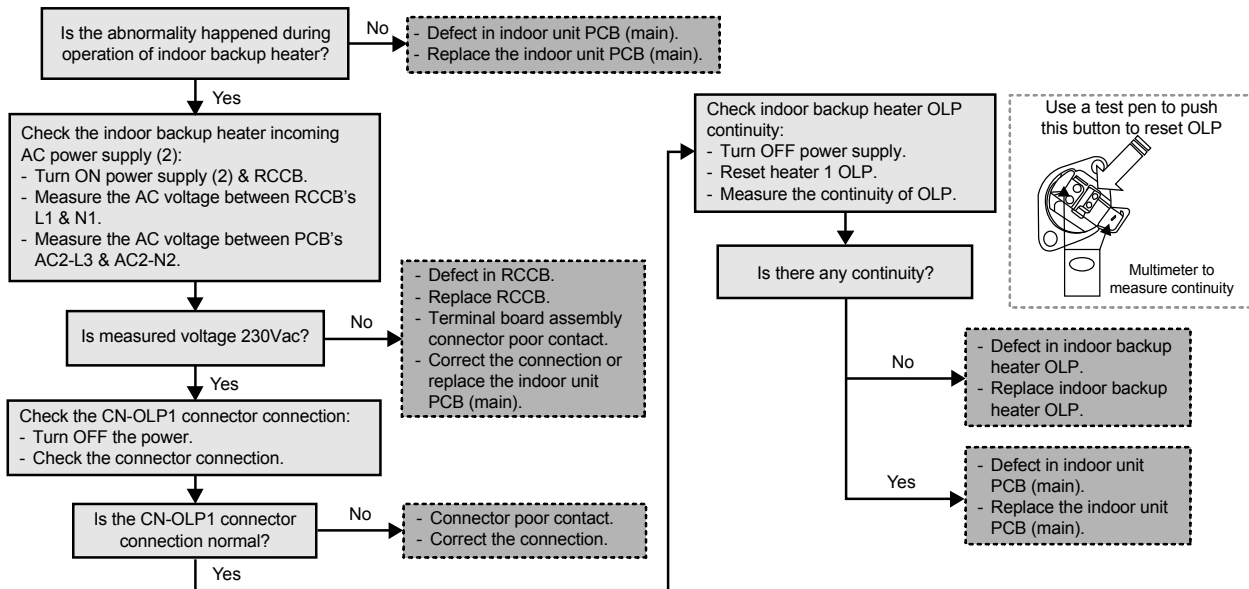

17.5.19 Tank Temperature Sensor Abnormality (H72)

Malfunction Decision Conditions:

When tank connection is set to ON, the temperatures detected by the tank temperature sensor are used to determine sensor error.

Malfunction Caused:

- 1 Faulty connector connection.
- 2 Faulty sensor.
- 3 Faulty indoor unit PCB (main).

Abnormality Judgment:

Continue for 5 seconds.

Troubleshooting:



Caution

For safety reason and to prevent component breakdown, always switch off the power before remove and connect the component.

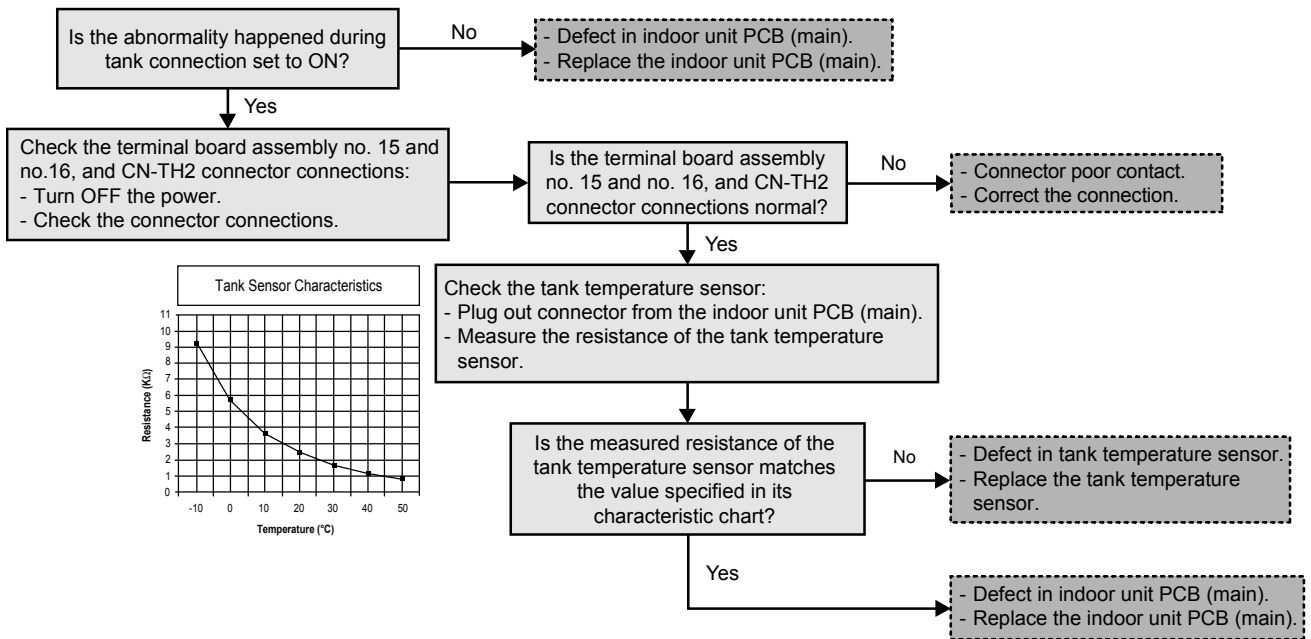

17.5.20 PCB Communication Error (H74)

Malfunction Decision Conditions:

When External PCB connection is select "YES" and no communication with External PCB micon for 10 seconds and above.

Malfunction Caused:

- 1 Faulty connector connection.
- 2 Faulty indoor PCB.
- 3 Faulty indoor sub PCB.

Abnormality Judgment:

After 1 minute operation started.

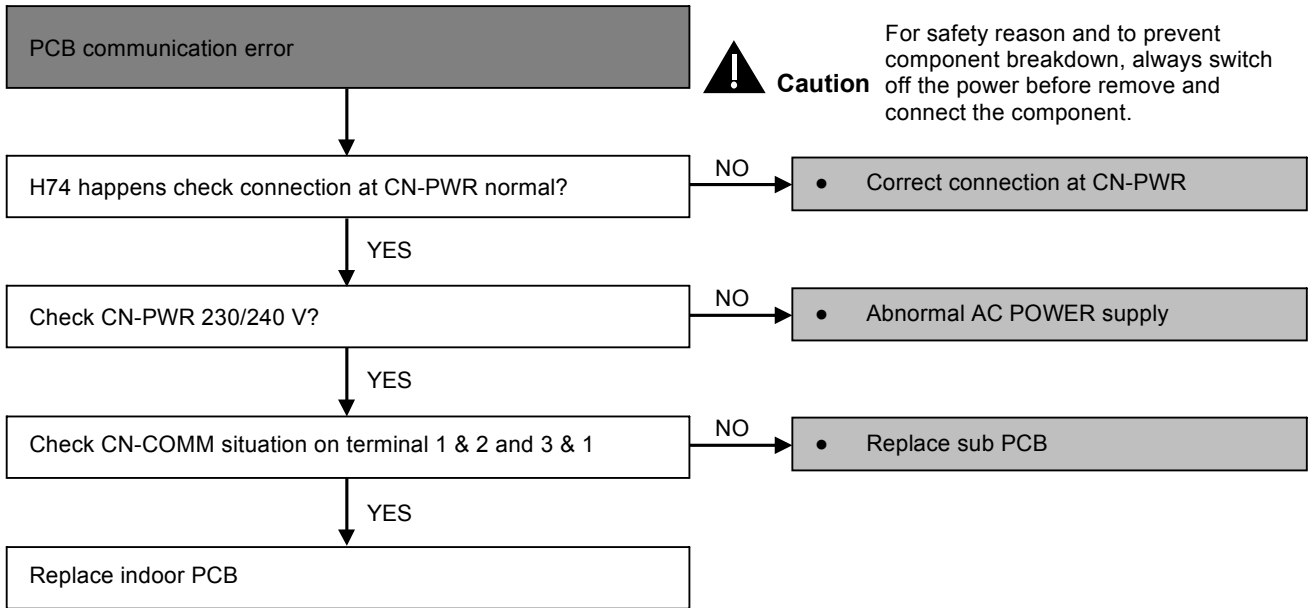

17.5.21 Indoor-Control Panel Communication Abnormality (H76)

Malfunction Decision Conditions:

During standby and operation of cooling and heating, indoor-control panel error occur.

Malfunction Caused:

- 1 Faulty connector connection.
- 2 Faulty control panel.
- 3 Faulty indoor unit PCB (main).

Troubleshooting:



Caution

For safety reason and to prevent component breakdown, always switch off the power before remove and connect the component.

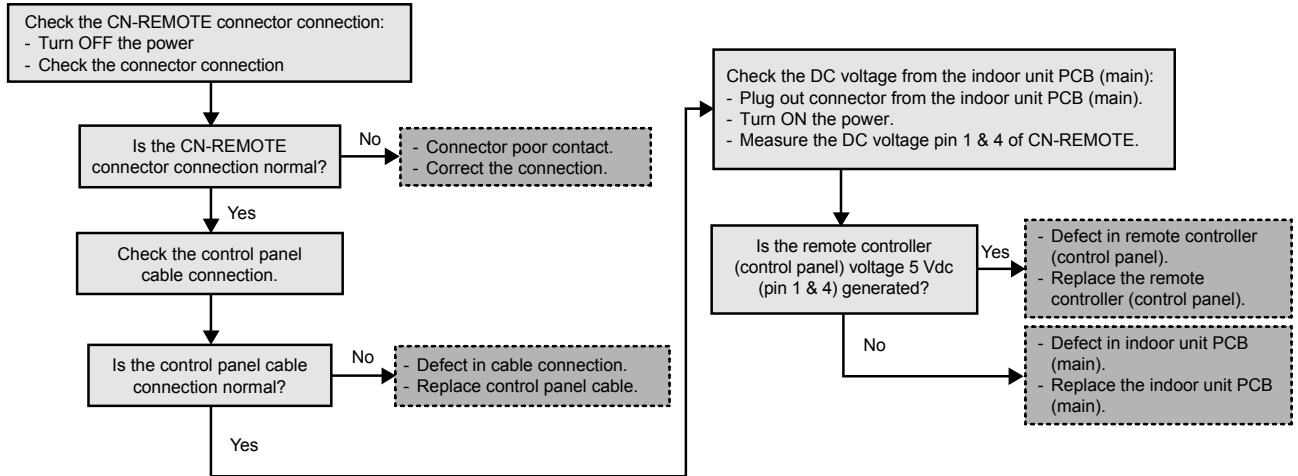

17.5.22 Indoor/Outdoor Abnormal Communication (H90)

Malfunction Decision Conditions:

During operation of cooling and heating, the data received from outdoor unit in indoor unit signal transmission is checked whether it is normal.

Malfunction Caused:

- 1 Faulty outdoor unit PCB (main).
- 2 Faulty indoor unit PCB (main).
- 3 Indoor-outdoor signal transmission error due to wrong wiring.
- 4 Indoor-outdoor signal transmission error due to breaking of wire in the connection wires between the indoor and outdoor units.
- 5 Indoor-outdoor signal transmission error due to disturbed power supply waveform.

Abnormality Judgment:

Continue for 1 minute after operation.

Troubleshooting:



Caution

For safety reason and to prevent component breakdown, always switch off the power before remove and connect the component.

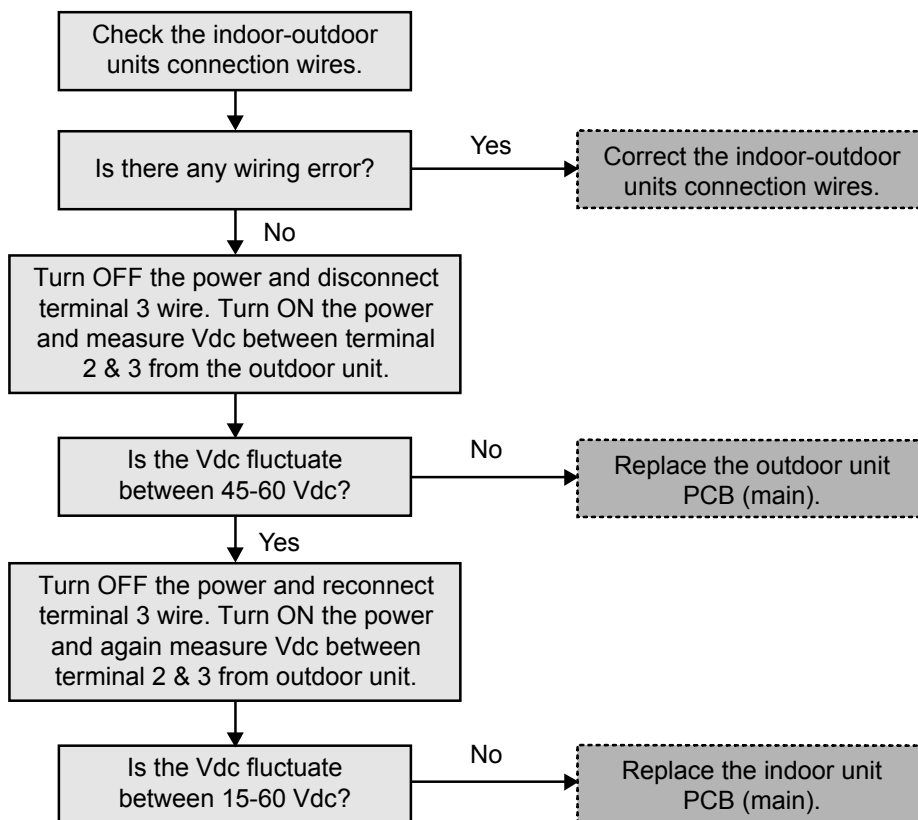

17.5.23 Tank Booster Heater OLP Abnormality (H91)

Malfunction Decision Conditions:

During operation of tank booster heater, and tank booster heater OLP open circuit.

Malfunction Caused:

- 1 Faulty connector connection.
- 2 Faulty tank booster heater overload protector (OLP).
- 3 Faulty indoor unit PCB (main).

Abnormality Judgment:

Continue for 60 seconds.

Troubleshooting:



Caution

For safety reason and to prevent component breakdown, always switch off the power before remove and connect the component.

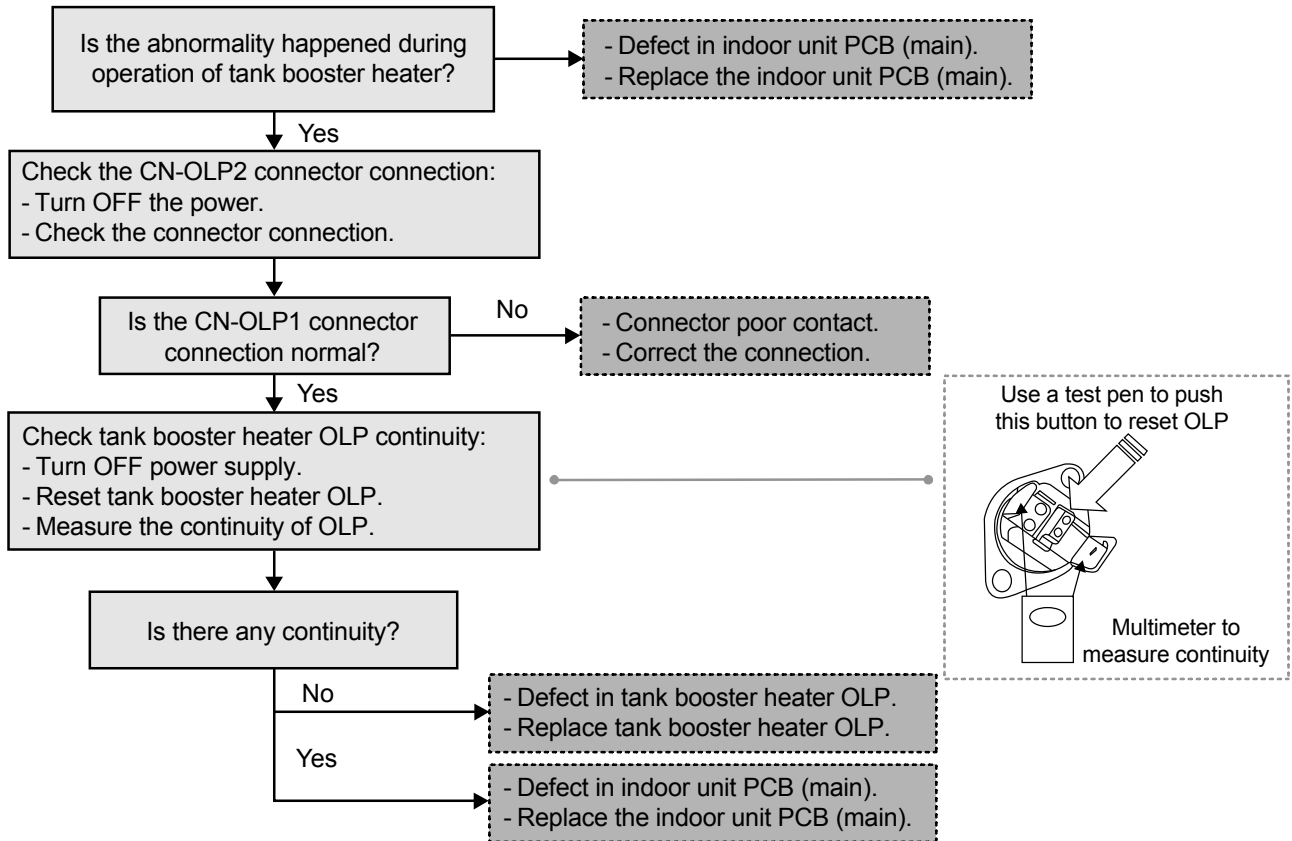

17.5.24 Unspecified Voltage between Indoor and Outdoor (H95)

Malfunction Decision Conditions:

The supply power is detected for its requirement by the indoor/outdoor transmission.

Malfunction Caused:

- 1 Insufficient power supply.
- 2 Faulty outdoor unit PCB (noise filter/main).

Troubleshooting:



Caution

For safety reason and to prevent component breakdown, always switch off the power before remove and connect the component.

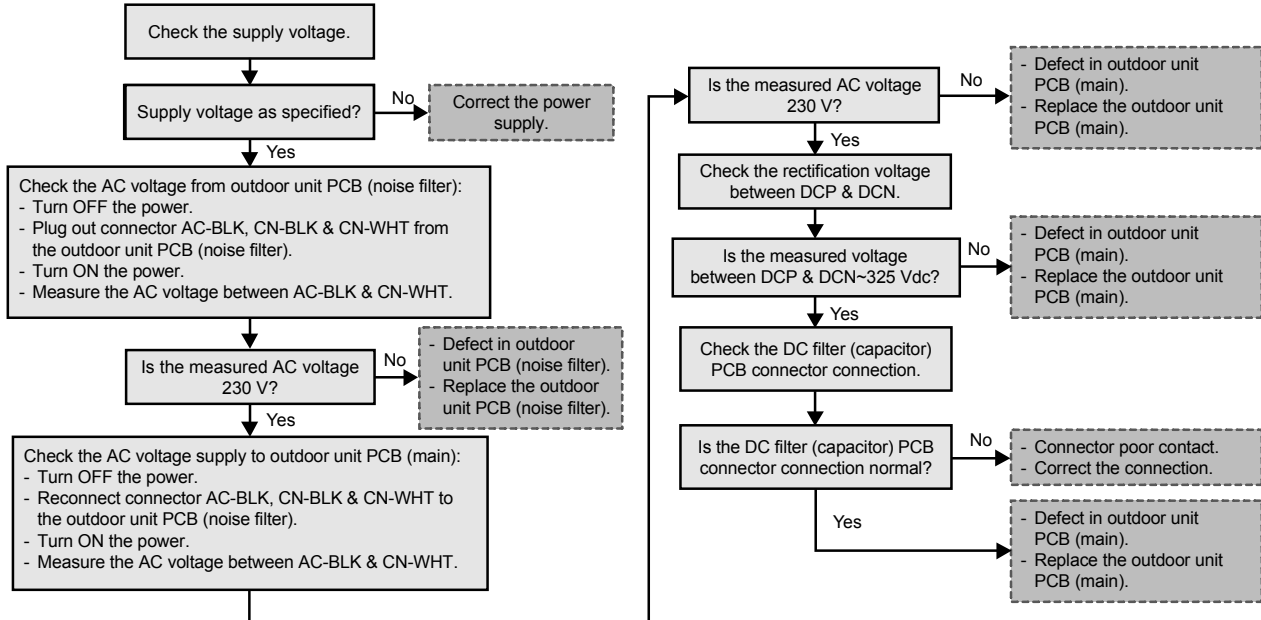

17.5.25 Outdoor Fan Motor – DC Motor Mechanism Locked (H97)

Malfunction Decision Conditions:

The rotation speed detected by the Hall IC during fan motor operation is used to determine abnormal fan motor.

Malfunction Caused:

- 1 Operation stops due to short circuit inside the fan motor winding.
- 2 Operation stops due to breaking of wire inside the fan motor.
- 3 Operation stops due to breaking of fan motor lead wires.
- 4 Operation stops due to Hall IC malfunction.
- 5 Operation error due to faulty outdoor unit PCB.

Troubleshooting:

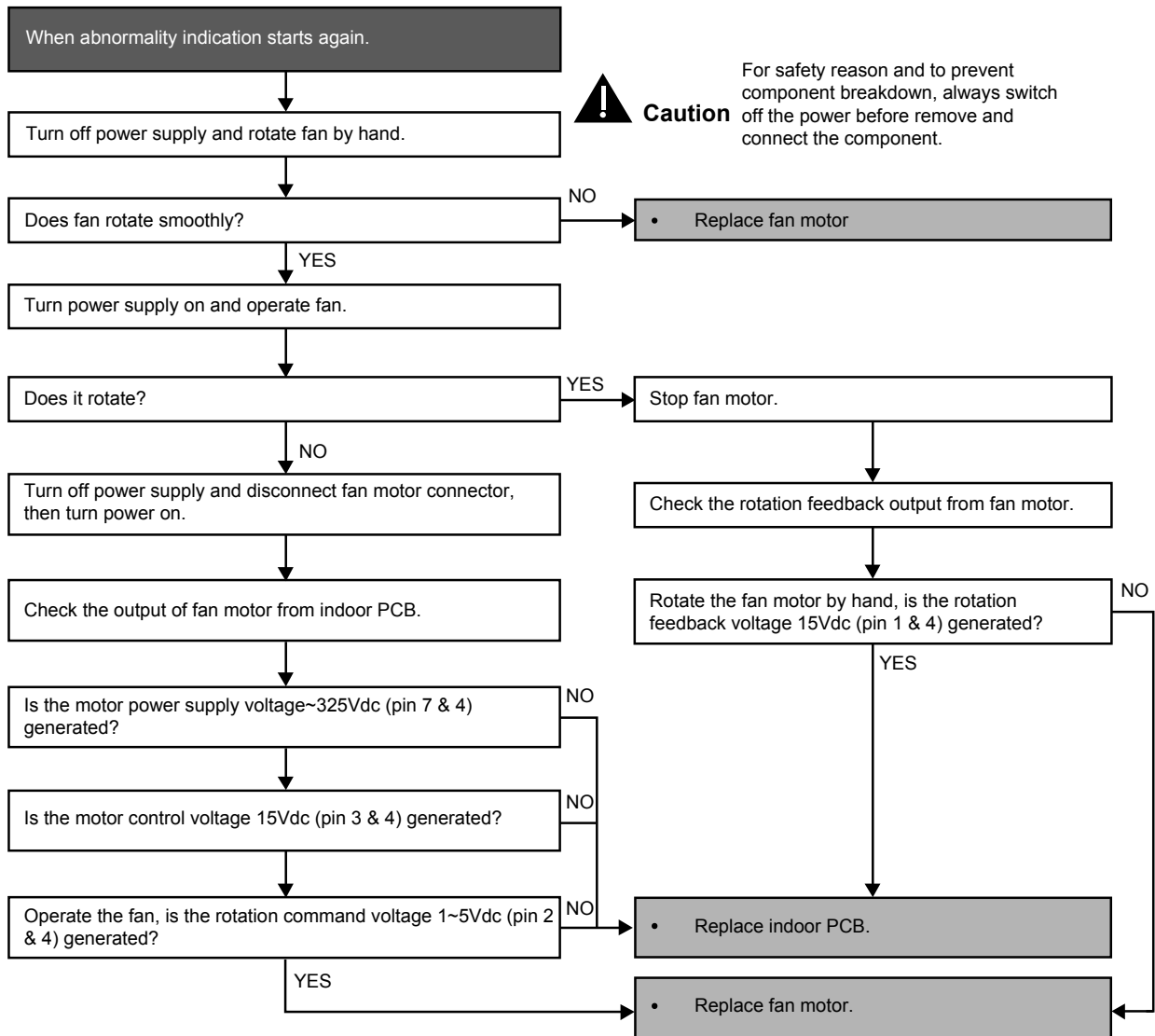

17.5.26 Outdoor High Pressure Protection (H98)

Malfunction Decision Conditions:

During operation of heating, when pressure 4.0 MPa and above is detected by outdoor high pressure sensor.

Malfunction Caused:

- 1 Faulty water pump.
- 2 Insufficient water flow rate in system.
- 3 Water leak in system.
- 4 2/3 way closed.
- 5 Clogged expansion valve or strainer.
- 6 Excessive refrigerant.
- 7 Faulty outdoor high pressure sensor.
- 8 Faulty outdoor unit PCB (main).

Troubleshooting: Caution

For safety reason and to prevent component breakdown, always switch off the power before remove and connect the component.

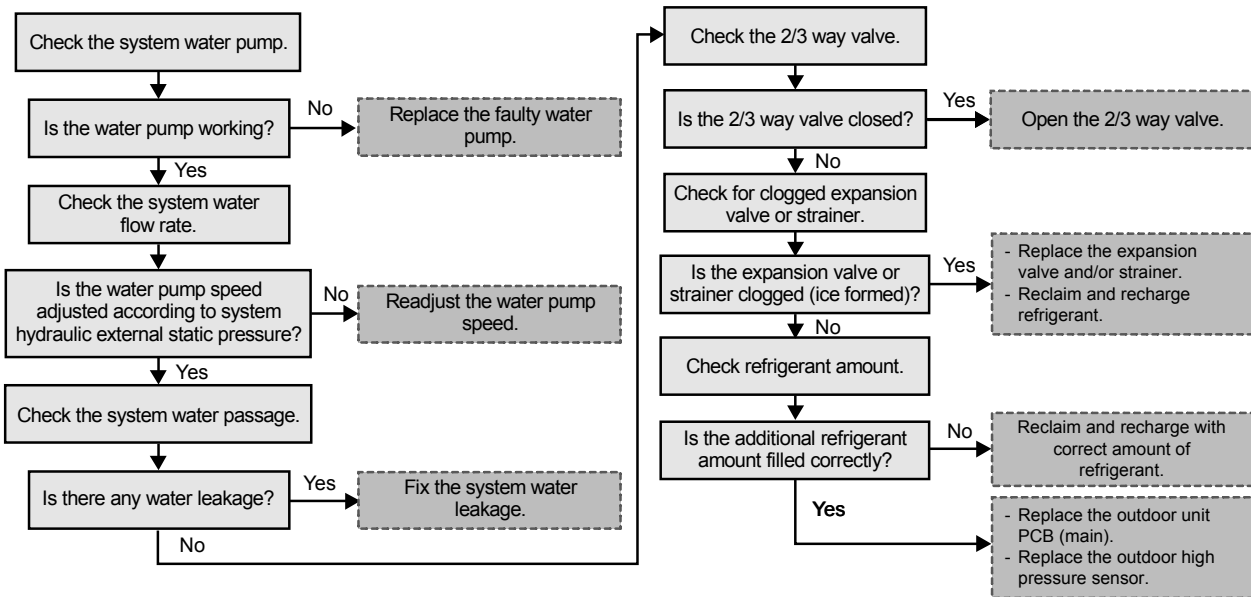

17.5.27 Indoor Freeze-up Protection (H99)

Malfunction Decision Conditions:

During anti-freezing control in cooling operation, when the indoor refrigerant liquid temperature $< 0^{\circ}\text{C}$.

Malfunction Caused:

- 1 Faulty water pump.
- 2 Insufficient water flow rate in system.
- 3 Water leak in system.
- 4 2 way valve partially closed.
- 5 Clogged expansion valve or strainer.
- 6 Refrigerant shortage (refrigerant leakage).
- 7 Faulty indoor refrigerant liquid temperature sensor.
- 8 Faulty indoor unit PCB (main).

Troubleshooting:



Caution

For safety reason and to prevent component breakdown, always switch off the power before remove and connect the component.

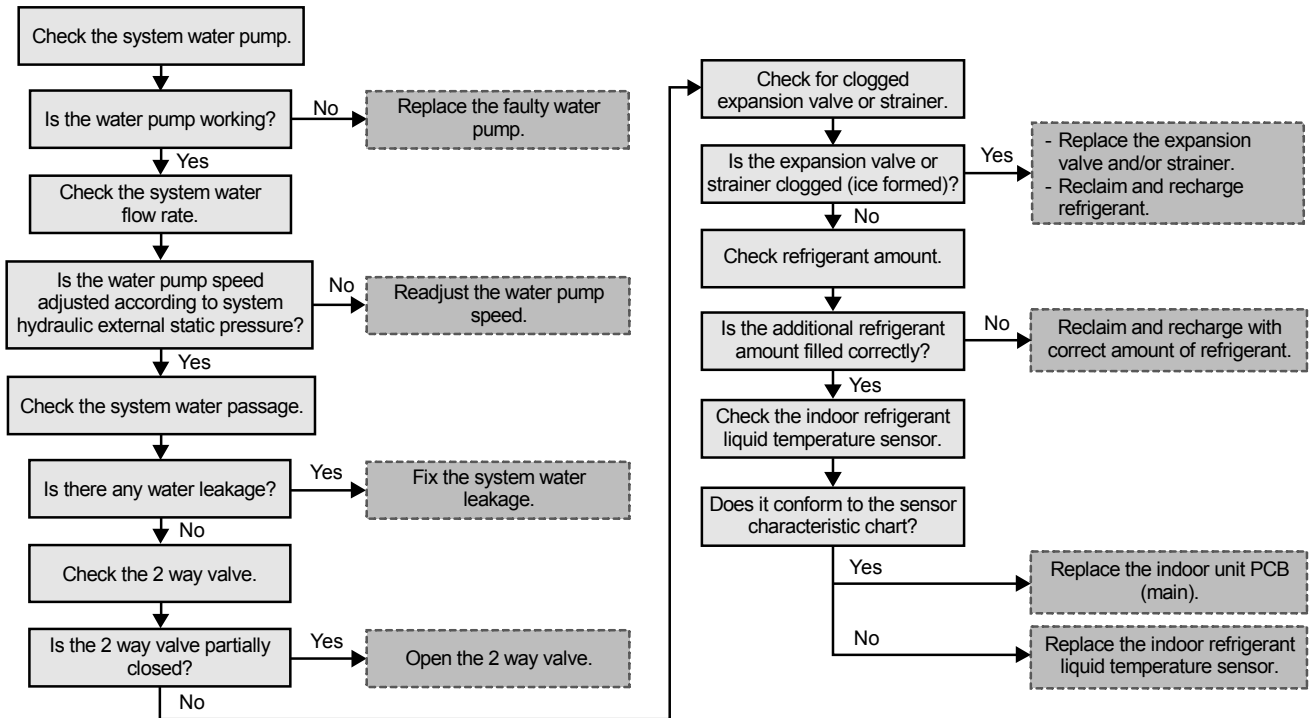

17.5.28 Outdoor High Pressure Switch Activate (F12)

Malfunction Decision Conditions:

During operation of cooling and heating, when pressure 4.5 MPa and above is detected by outdoor high pressure switch.

Malfunction Caused:

- 1 Dust accumulation on the outdoor unit heat exchanger.
- 2 Air short circuit at outdoor unit.
- 3 Faulty water pump.
- 4 Insufficient water flow rate in system.
- 5 Water leak in system.
- 6 2/3 way valve closed.
- 7 Clogged expansion valve or strainer.
- 8 Excessive refrigerant.
- 9 Faulty outdoor high pressure sensor and switch.
- 10 Faulty outdoor unit PCB.

Abnormality Judgment:

Continue 4 times in 20 minutes.

Troubleshooting:



Caution

For safety reason and to prevent component breakdown, always switch off the power before remove and connect the component.

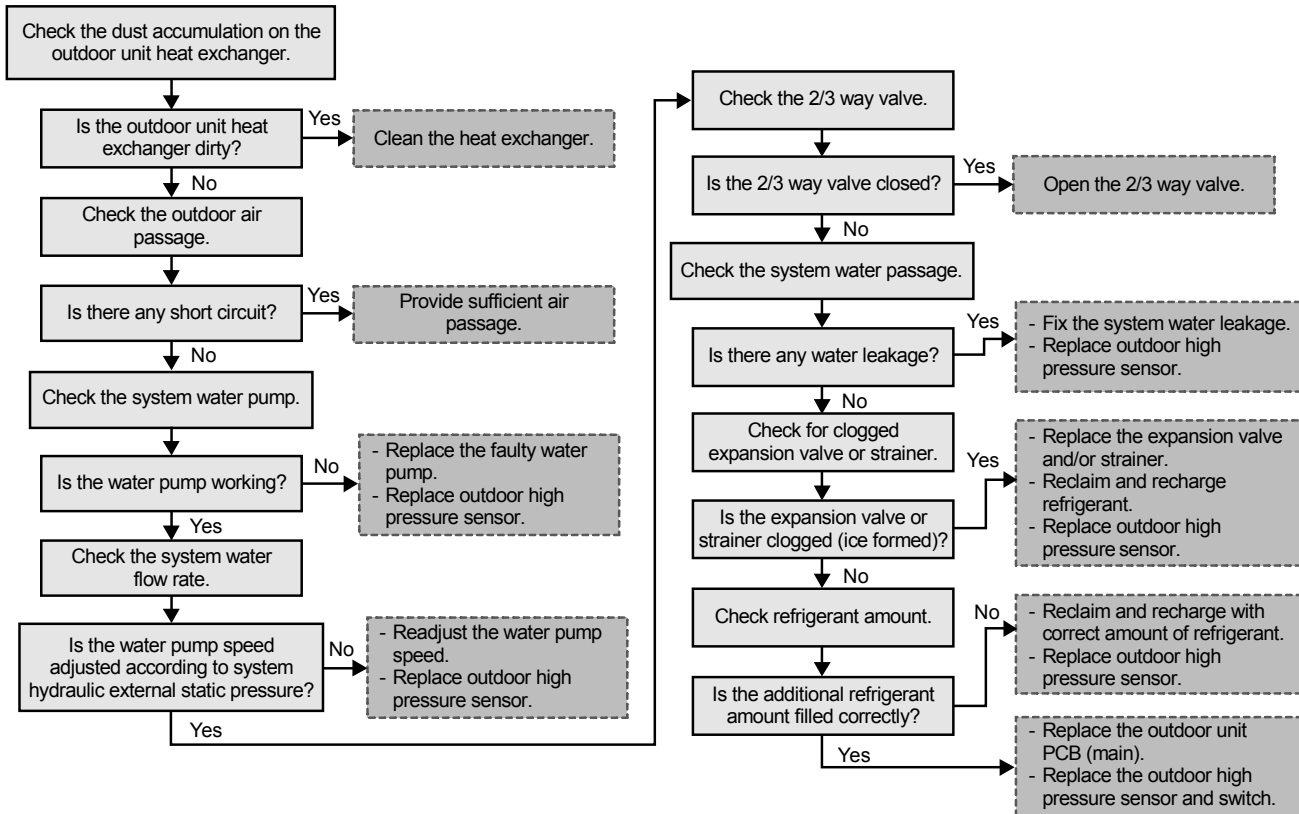

17.5.29 Compressor Rotation Failure (F14)

Malfunction Decision Conditions:

A compressor rotation failure is detected by checking the compressor running condition through the position detection circuit.

Malfunction Caused:

- 1 Compressor terminal disconnect.
- 2 Faulty outdoor unit PCB (main).
- 3 Faulty compressor.

Abnormality Judgment:

Continue 4 times in 20 minutes.

Troubleshooting:



Caution

For safety reason and to prevent component breakdown, always switch off the power before remove and connect the component.

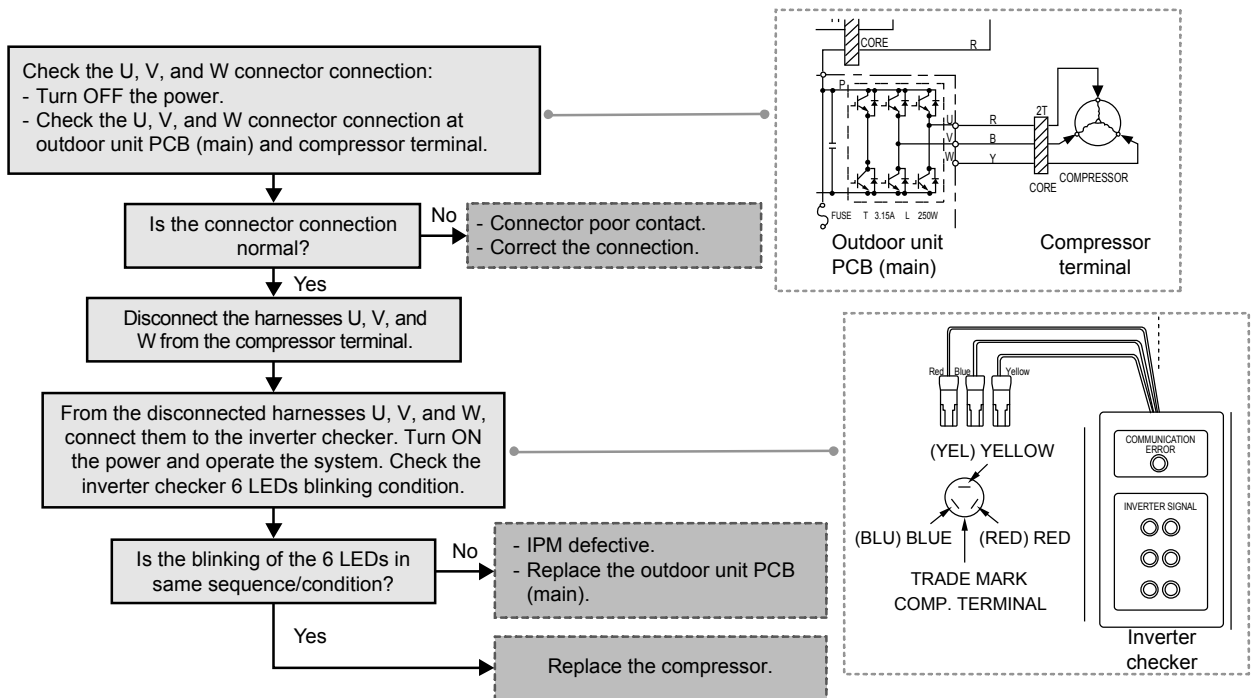

17.5.30 Outdoor Fan Motor (DC Motor) Mechanism Locked (F15)

Malfunction Decision Conditions:

The rotation speed detected by the Hall IC of the fan motor during fan motor operation is used to determine abnormal fan motor (feedback of rotation > 2550 rpm or < 50 rpm).

Malfunction Caused:

- 1 Operation stop due to short circuit inside the fan motor winding.
- 2 Operation stop due to breaking of wire inside the fan motor.
- 3 Operation stop due to breaking of fan motor lead wires.
- 4 Operation stop due to fan motor Hall IC malfunction.
- 5 Operation error due to faulty outdoor unit PCB.

Abnormality Judgment:

Continue 2 times in 30 minutes.

Troubleshooting:



Caution

For safety reason and to prevent component breakdown, always switch off the power before remove and connect the component.

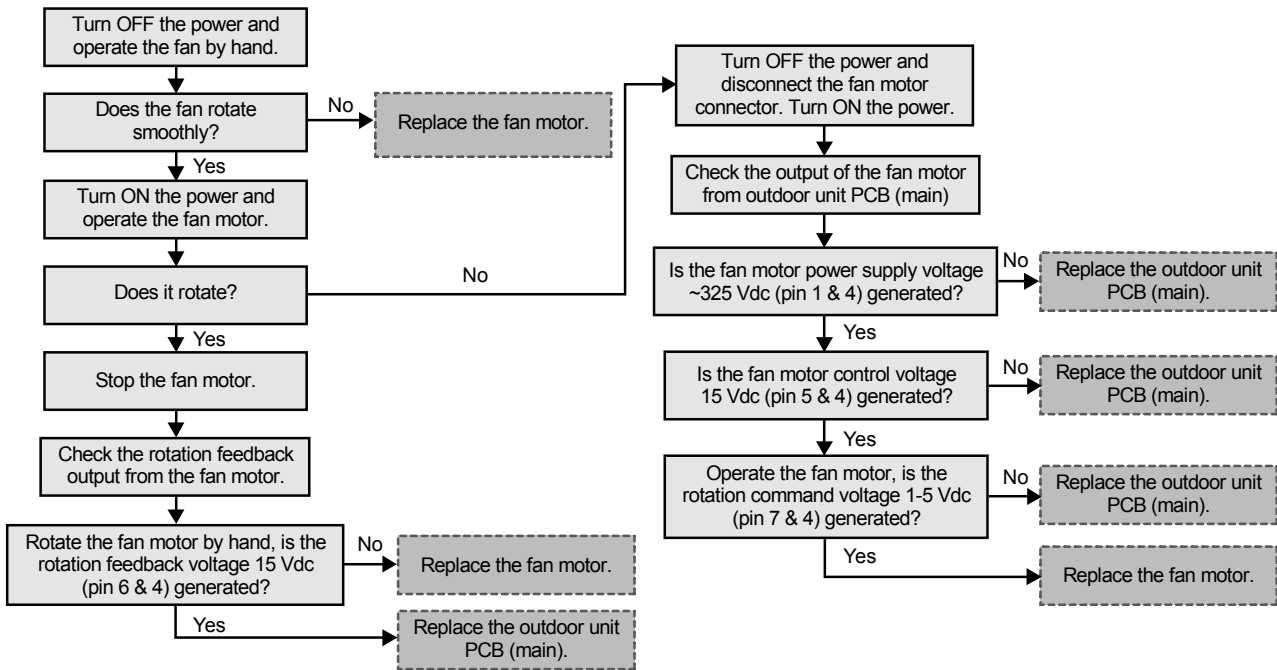

17.5.31 Input Over Current Detection (F16)

Malfunction Decision Conditions:

During operation of cooling and heating, when outdoor current above 11.8A (UX09HE8, UX12HE8), 16.5A (UX16HE8), 10.6A (UD09HE8, UD12HE8, UD16HE8) is detected by the current transformer (CT) in the outdoor unit PCB.

Malfunction Caused:

- 1 Excessive refrigerant.
- 2 Faulty outdoor unit PCB (main).

Abnormality Judgment:

Continue 3 times in 20 minutes.

Troubleshooting:



Caution

For safety reason and to prevent component breakdown, always switch off the power before remove and connect the component.

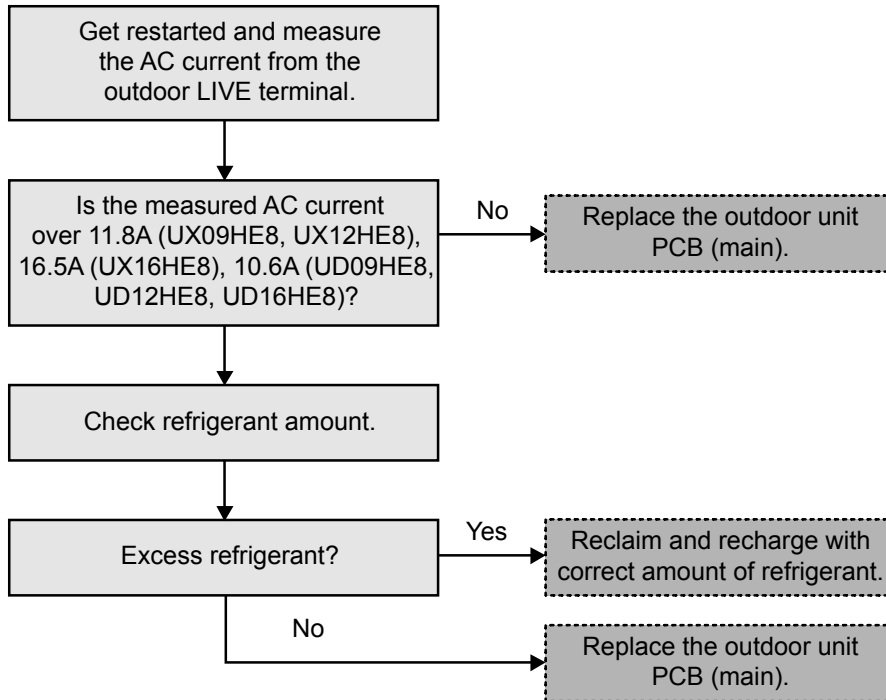

17.5.32 Compressor Overheating (F20)

Malfunction Decision Conditions:

During operation of cooling and heating, when temperature above 112°C is detected by the compressor tank temperature sensor.

Malfunction Caused:

- 1 Faulty compressor tank temperature sensor.
- 2 2/3 way valve closed.
- 3 Refrigerant shortage (refrigerant leakage).
- 4 Clogged expansion valve or strainer.
- 5 Faulty outdoor unit PCB (main).
- 6 Faulty compressor.

Abnormality Judgment:

Continue 4 times in 30 minutes.

Troubleshooting:



Caution

For safety reason and to prevent component breakdown, always switch off the power before remove and connect the component.

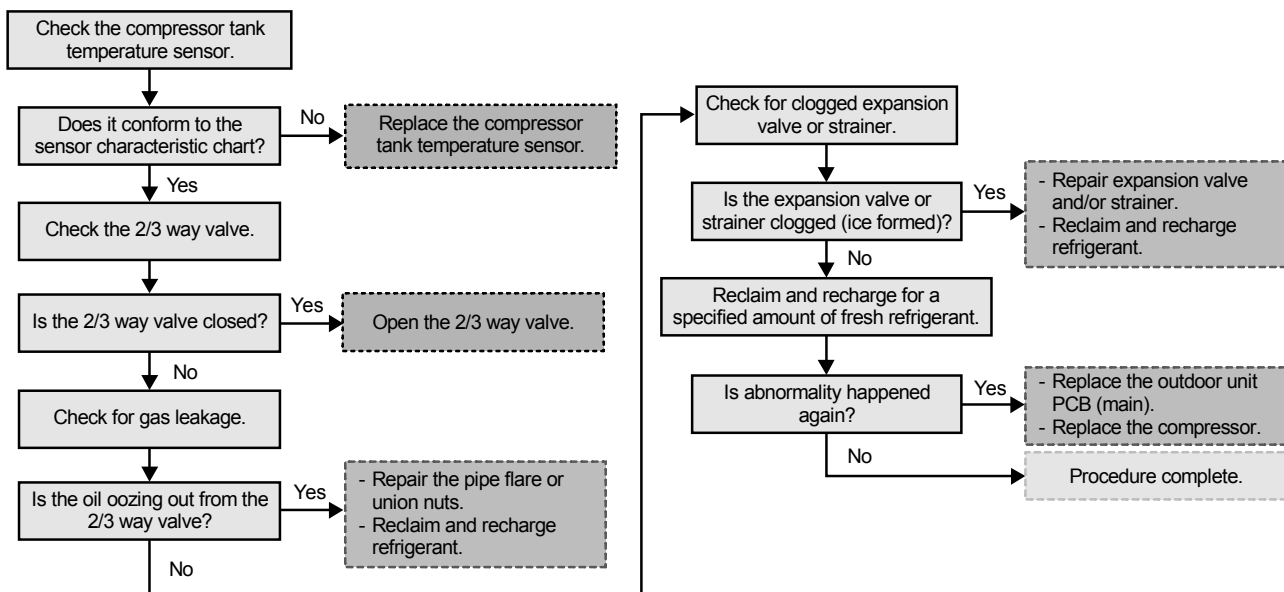

17.5.33 IPM Overheating (F22)

Malfunction Decision Conditions:

During operation of cooling and heating, when temperature 95°C is detected by the outdoor IPM temperature sensor.

Malfunction Caused:

- 1 Faulty outdoor unit fan motor.
- 2 Faulty outdoor unit PCB (main).

Abnormality Judgment:

Continue 3 times in 30 minutes.

Troubleshooting:



Caution

For safety reason and to prevent component breakdown, always switch off the power before remove and connect the component.

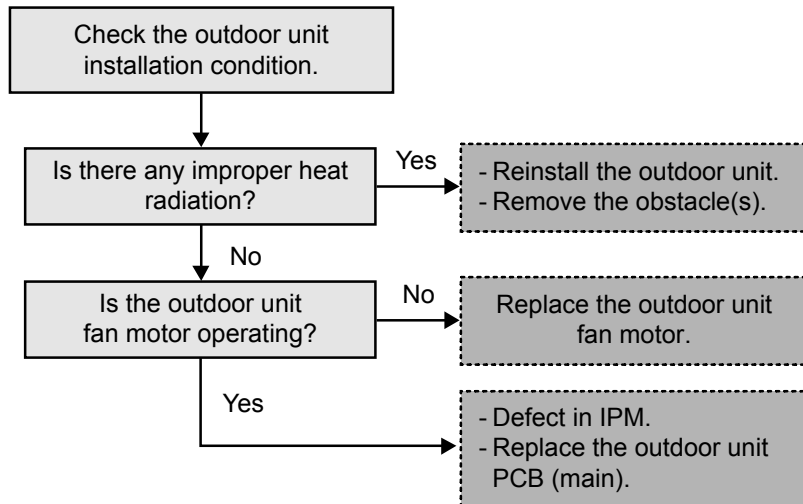

17.5.34 Output Over Current Detection (F23)

Malfunction Decision Conditions:

During operation of cooling and heating, when outdoor DC current is above 34A (UX09HE8, UX12HE8, UD09HE8, UD12HE8, UD16HE8), 54A (UX16HE8) is detected by the IPM DC Peak sensing circuitry in the outdoor unit PCB (main).

Malfunction Caused:

- 1 Faulty outdoor unit PCB (main).
- 2 Faulty compressor.

Abnormality Judgment:

Continue for 7 times.

Troubleshooting:



Caution

For safety reason and to prevent component breakdown, always switch off the power before remove and connect the component.

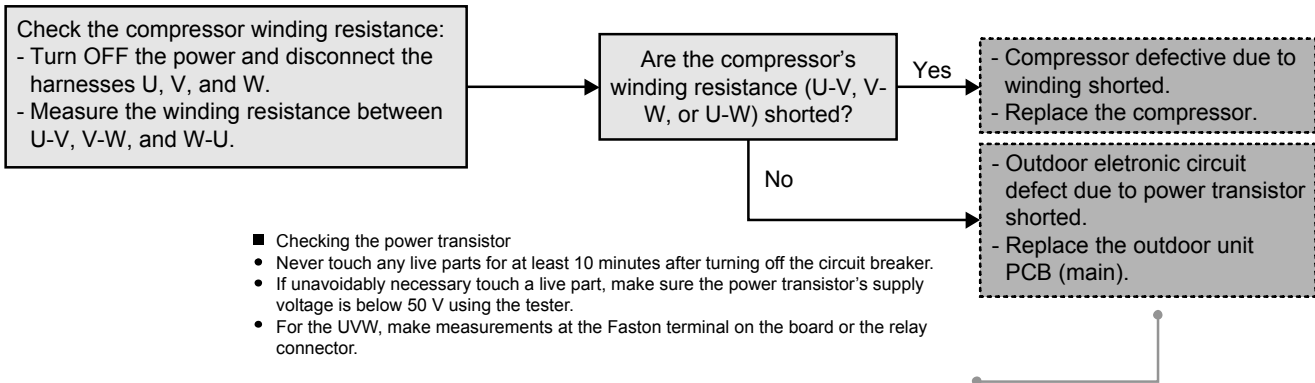

Tester's negative terminal	Power transistor (+)	UVW	Power transistor (-)	UVW
Tester's positive terminal	UVW	Power transistor (+)	UVW	Power transistor (-)
Normal resistance	Several kohms to several Mohms			
Abnormal resistance	0 or ∞			

17.5.35 Refrigeration Cycle Abnormality (F24)

Malfunction Decision Conditions:

- 1 During operation of cooling and heating, compressor frequency > Frated.
- 2 During operation of cooling and heating, running current: $0.65 A < I < 1.65 A$.
- 3 During operation of cooling, water inlet temperature - indoor refrigerant liquid temperature < 4°C.
- 4 During operation of heating, indoor refrigerant liquid temperature - water inlet temperature < 5°C.

Malfunction Caused:

- 1 Faulty water inlet or indoor refrigerant liquid temperature sensors.
- 2 2/3 way valve closed.
- 3 Refrigerant shortage (refrigerant leakage).
- 4 Clogged expansion valve or strainer.
- 5 Faulty outdoor unit PCB (main).
- 6 Poor compression of compressor.

Abnormality Judgment:

Continue 2 times in 20 minutes.

Troubleshooting:



Caution

For safety reason and to prevent component breakdown, always switch off the power before remove and connect the component.

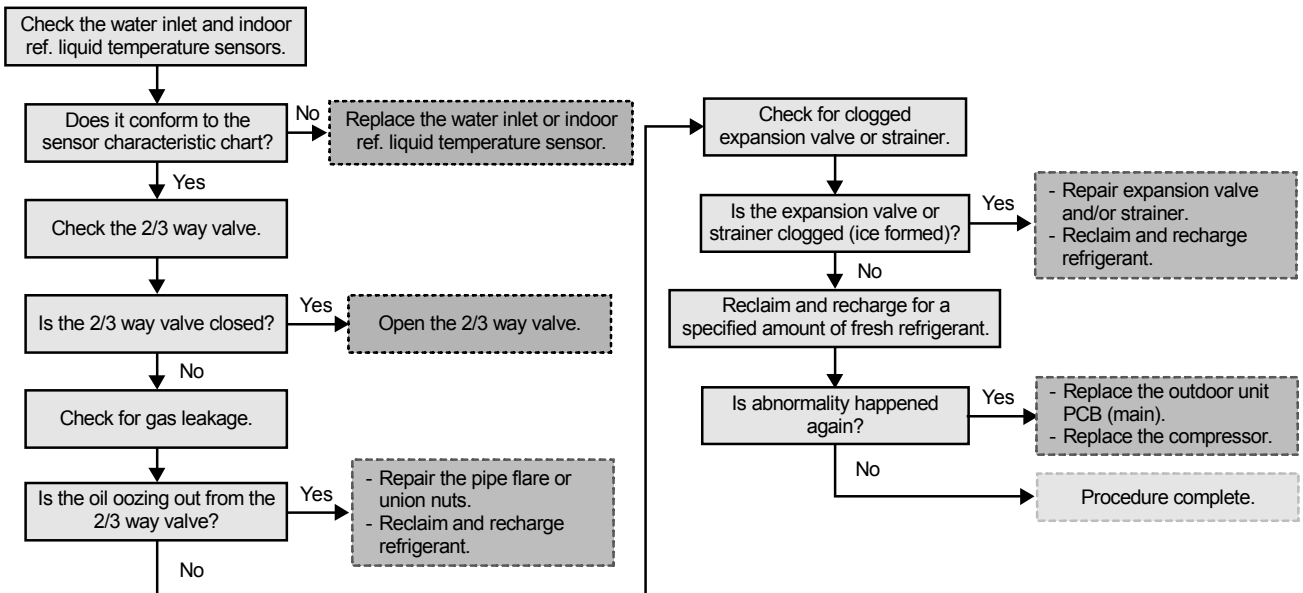

17.5.36 Four Way Valve Abnormality (F25)

Malfunction Decision Conditions:

- 1 During heating operation, when the indoor pipe temperature of thermostat ON indoor unit < 0°C.
- 2 During cooling operation, when the indoor pipe temperature of thermostat ON indoor unit > 45°C.

Malfunction Caused:

- 1 Faulty sensor.
- 2 Faulty connector connection.
- 3 Faulty outdoor unit PCB (noise filter/main).
- 4 Faulty four way valve.

Abnormality Judgment:

Continue 4 times in 30 minutes.

Troubleshooting:



Caution

For safety reason and to prevent component breakdown, always switch off the power before remove and connect the component.

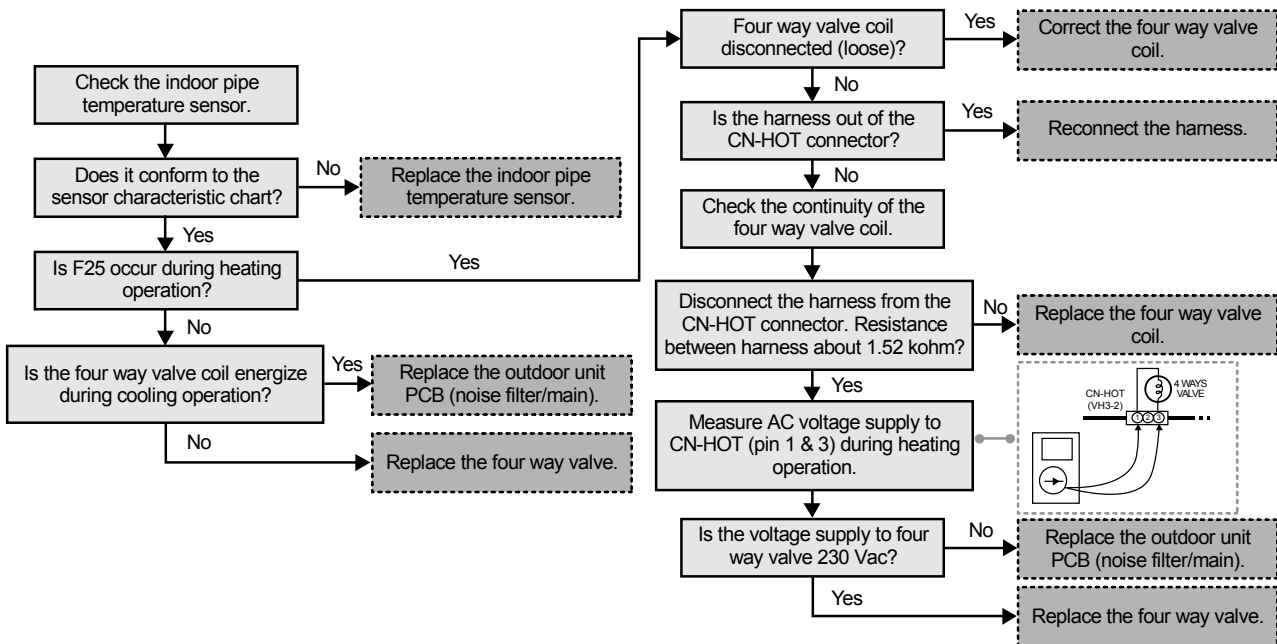

17.5.37 Outdoor High Pressure Switch Abnormal (F27)

Malfunction Decision Conditions:

During compressor stop, and outdoor high pressure switch is remain opened.

Malfunction Caused:

- 1 Faulty connector connection.
- 2 Faulty switch.
- 3 Faulty outdoor unit PCB (main).

Abnormality Judgment:

Continue for 1 minute.

Troubleshooting:



Caution

For safety reason and to prevent component breakdown, always switch off the power before remove and connect the component.

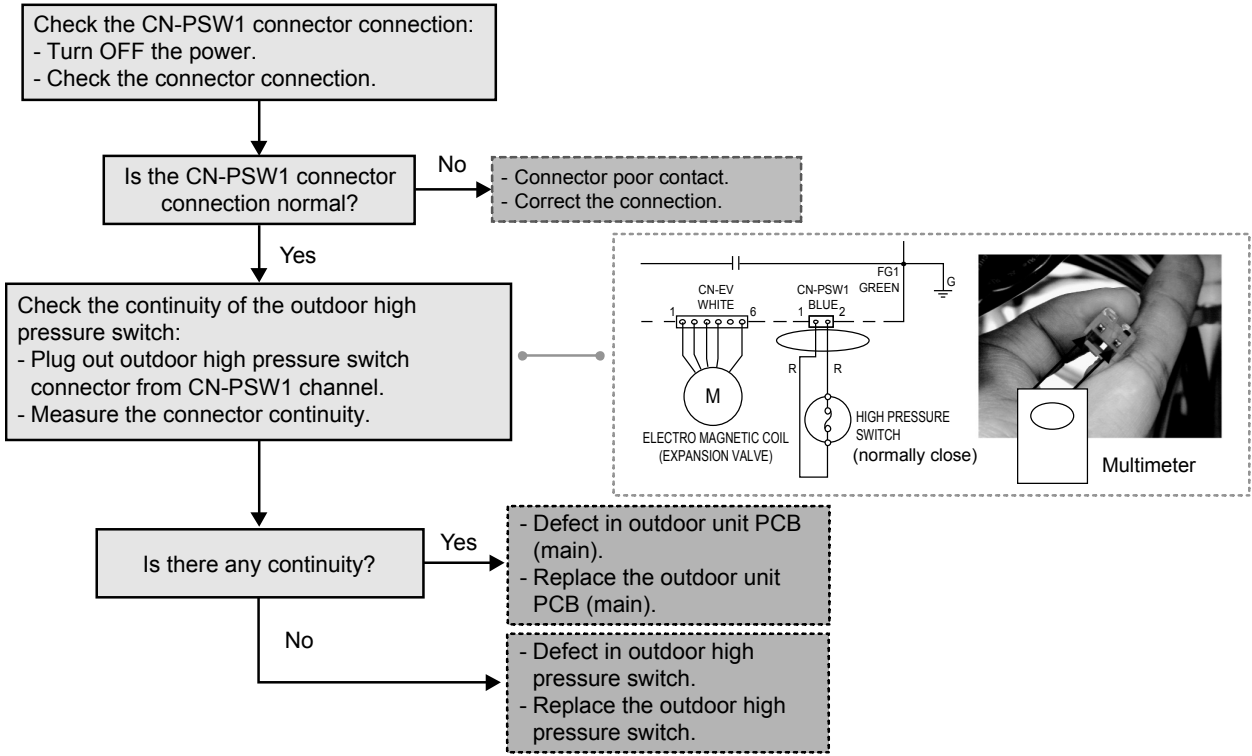

17.5.38 Low Discharge Superheat (F29)

Malfunction Decision Conditions:

During startup and operation of cooling and heating, the temperatures detected by the outdoor pipe temperature sensor are used to determine sensor error.

Malfunction Caused:

- 1 Faulty connector connection.
- 2 Faulty sensor.
- 3 Faulty outdoor unit PCB (main).
- 4 Faulty High Pressure Switch
- 5 Refrigerant shortage (refrigerant leakage).

Abnormality Judgment:

1 times occurrence within 2550 minutes.

Troubleshooting:



Caution

For safety reason and to prevent component breakdown, always switch off the power before remove and connect the component.

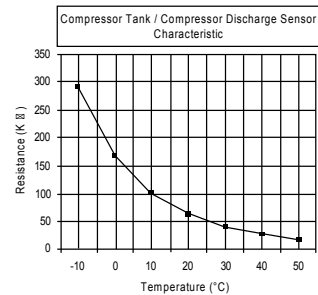
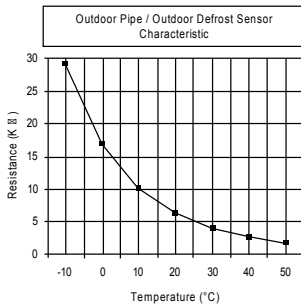
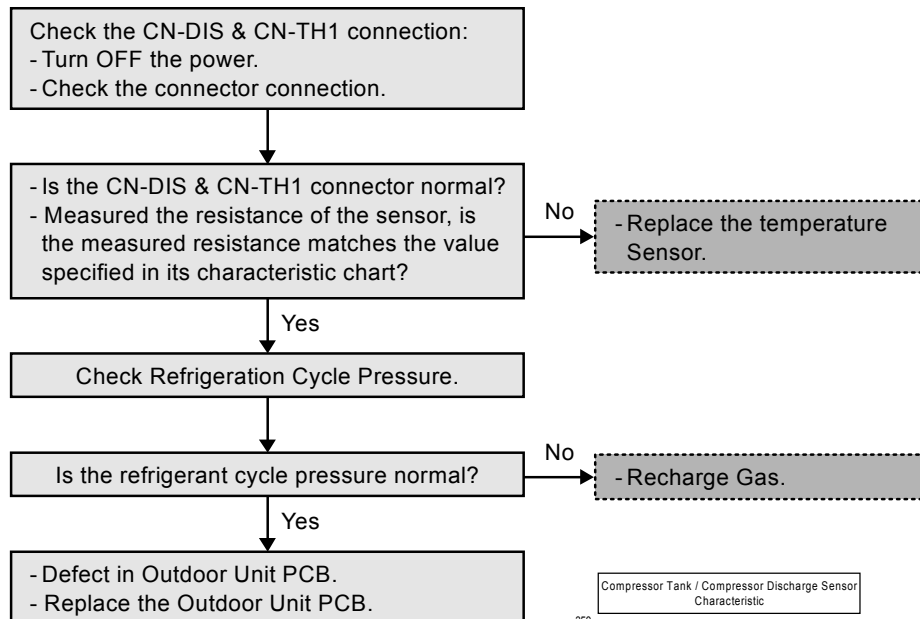

17.5.39 Indoor Water Outlet Temperature Sensor 2 Abnormality (F30)

Malfunction Decision Conditions:

During startup and operation of cooling and heating, the temperatures detected by the indoor water outlet temperature sensor 2 are used to determine sensor error.

Malfunction Caused:

- 1 Faulty connector connection.
- 2 Faulty sensor.
- 3 Faulty indoor unit PCB.

Abnormality Judgment:

Continue for 5 seconds.

Troubleshooting:



Caution

For safety reason and to prevent component breakdown, always switch off the power before remove and connect the component.

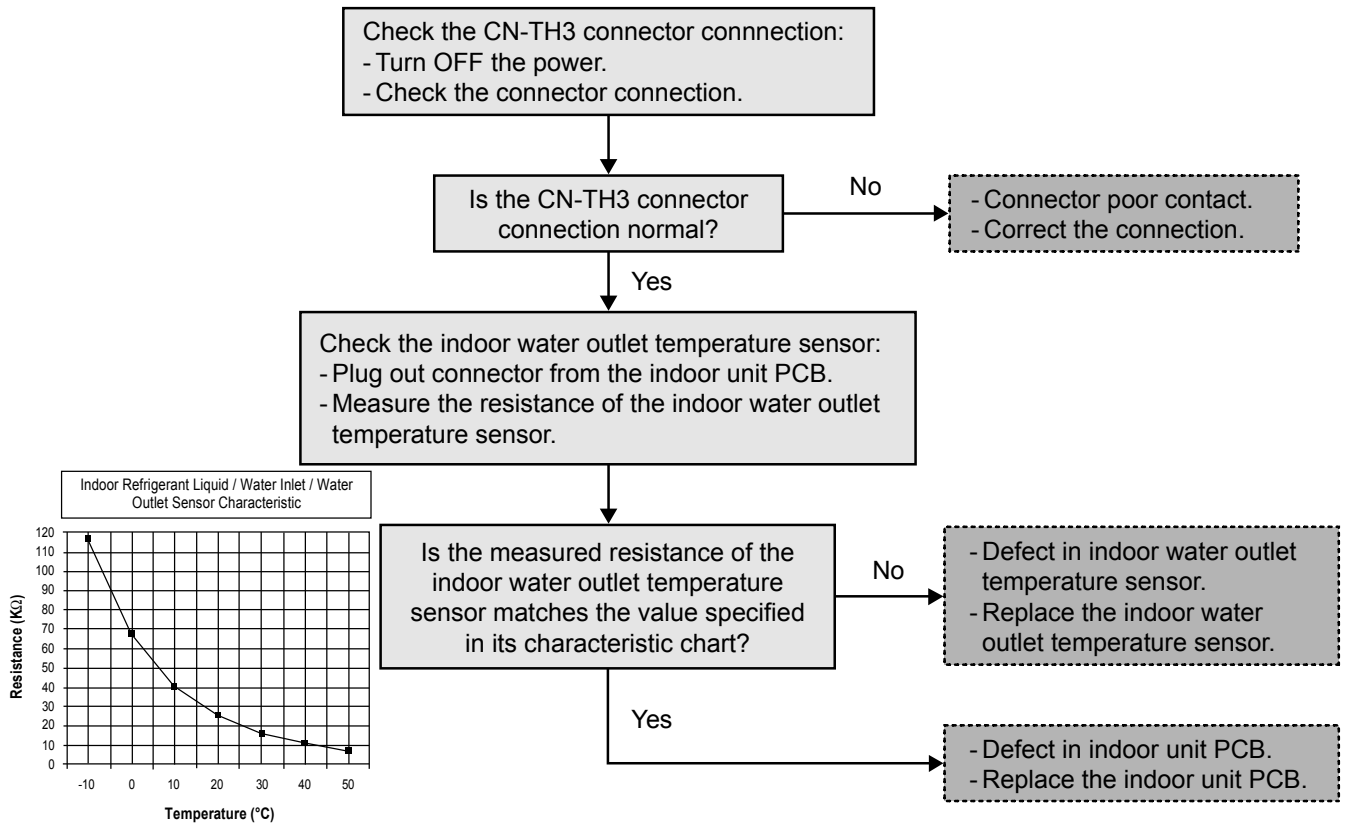

17.5.40 Outdoor Air Temperature Sensor Abnormality (F36)

Malfunction Decision Conditions:

During startup and operation of cooling and heating, the temperatures detected by the outdoor air temperature sensor are used to determine sensor error.

Malfunction Caused:

- 1 Faulty connector connection.
- 2 Faulty sensor.
- 3 Faulty outdoor unit PCB (main).

Abnormality Judgment:

Continue for 5 seconds.

Troubleshooting:



Caution

For safety reason and to prevent component breakdown, always switch off the power before remove and connect the component.

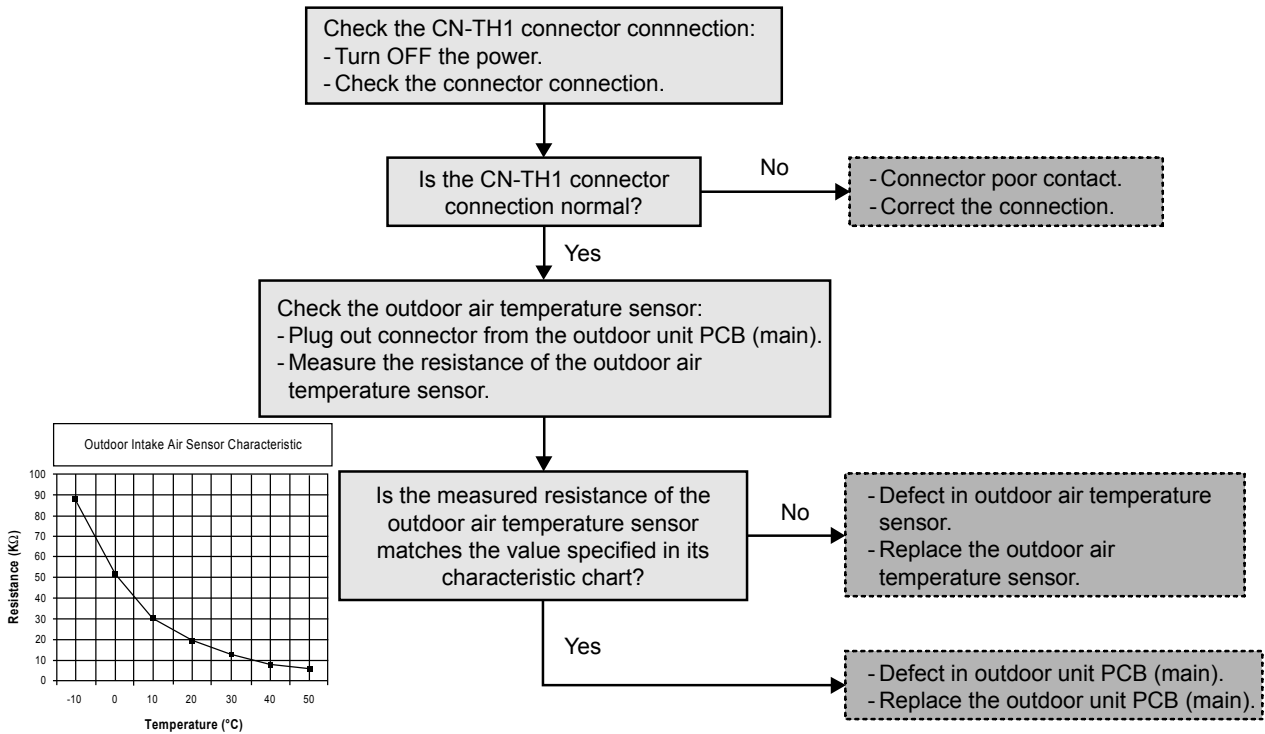

17.5.41 Indoor Water Inlet Temperature Sensor Abnormality (F37)

Malfunction Decision Conditions:

During startup and operation of cooling and heating, the temperatures detected by the indoor water inlet temperature sensor are used to determine sensor error.

Malfunction Caused:

- 1 Faulty connector connection.
- 2 Faulty sensor.
- 3 Faulty indoor unit PCB (main).

Abnormality Judgment:

Continue for 5 seconds.

Troubleshooting:



Caution

For safety reason and to prevent component breakdown, always switch off the power before remove and connect the component.

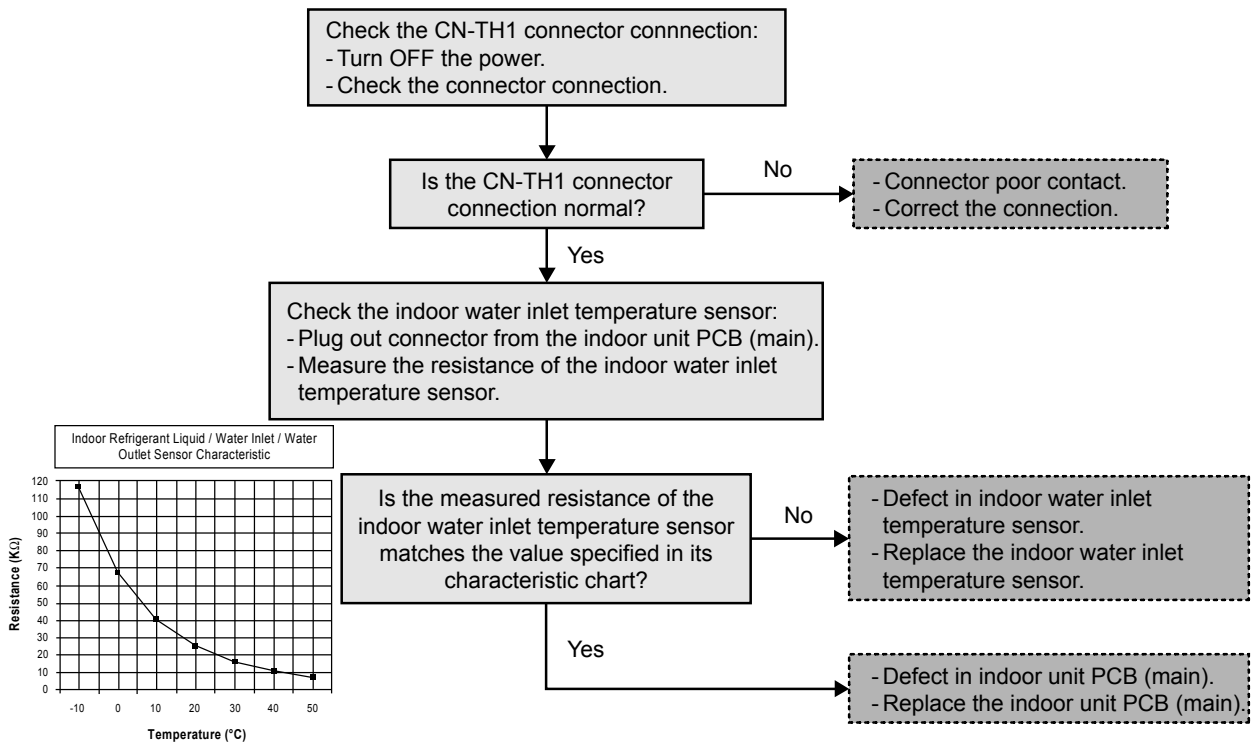

17.5.42 Outdoor Discharge Pipe Temperature Sensor Abnormality (F40)

Malfunction Decision Conditions:

During startup and operation of cooling and heating, the temperatures detected by the outdoor discharge pipe temperature sensor are used to determine sensor error.

Malfunction Caused:

- 1 Faulty connector connection.
- 2 Faulty sensor.
- 3 Faulty outdoor unit PCB (main).

Abnormality Judgment:

Continue for 5 seconds.

Troubleshooting:



Caution

For safety reason and to prevent component breakdown, always switch off the power before remove and connect the component.

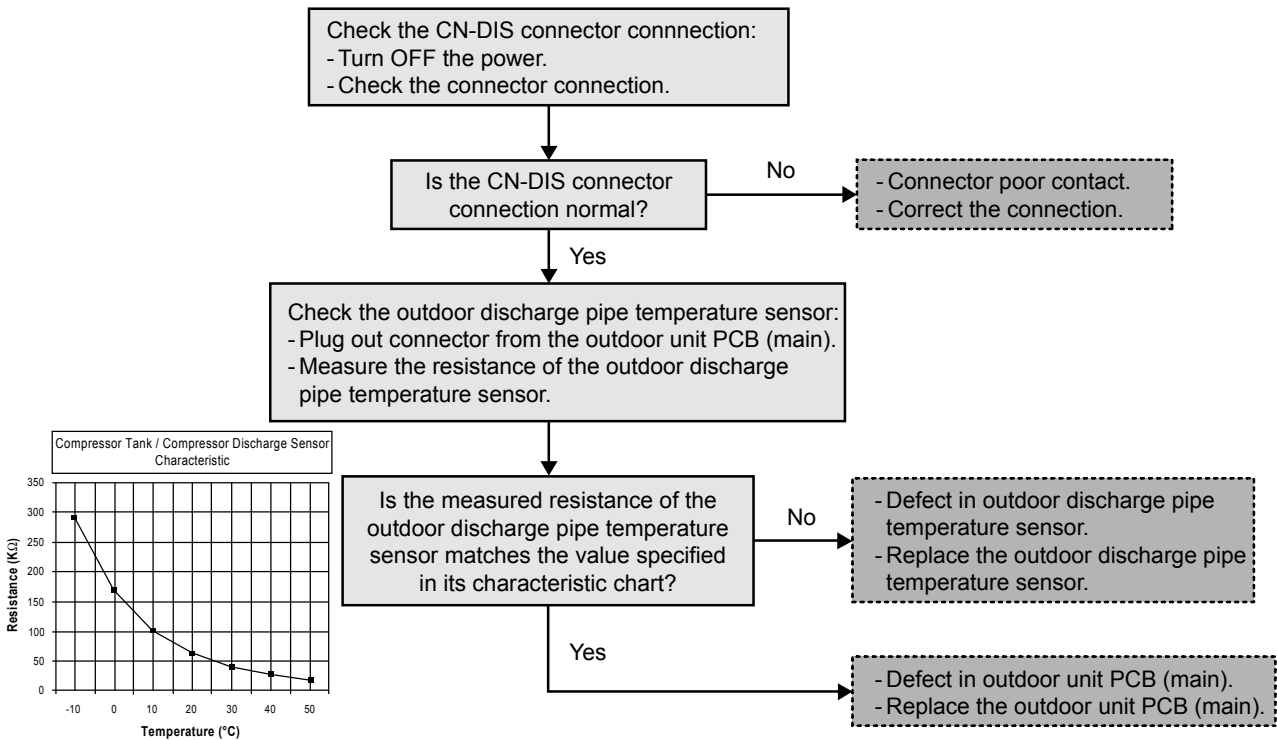

17.5.43 Power Factor Correction (PFC) Abnormality (F41)

Malfunction Decision Conditions:

During operation of cooling and heating, when the PFC protection circuitry in the outdoor unit PCB (main) senses abnormal high DC voltage level.

Malfunction Caused:

- 1 Power supply surge.
- 2 Compressor windings not uniform.
- 3 Faulty outdoor unit PCB (main).

Abnormality Judgment:

Continue 4 times in 10 minutes.

Troubleshooting:



Caution

For safety reason and to prevent component breakdown, always switch off the power before remove and connect the component.

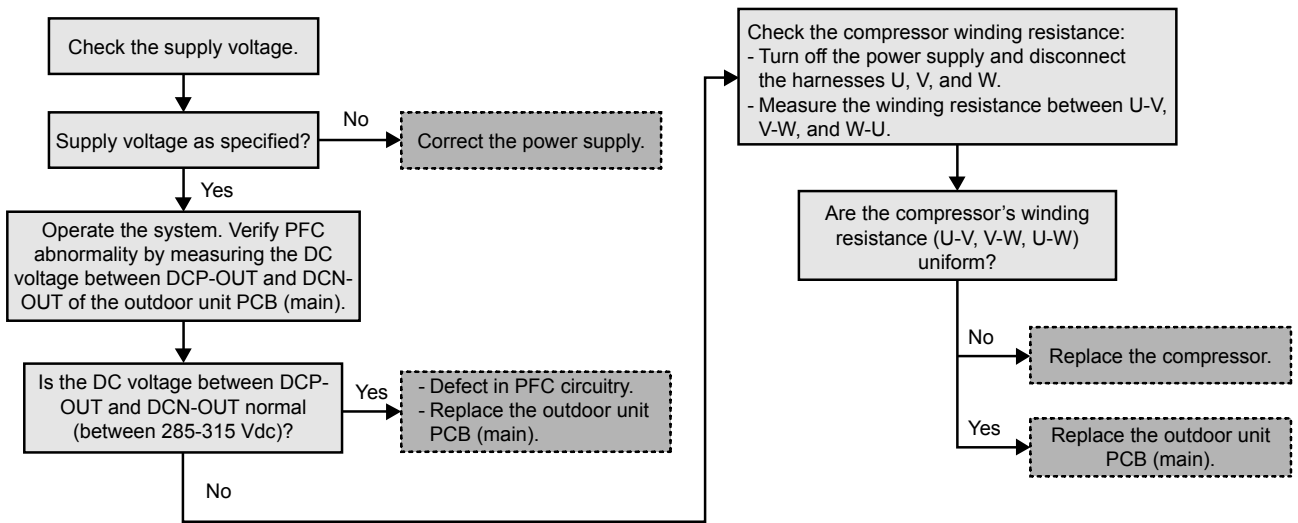

17.5.44 Outdoor Pipe Temperature Sensor Abnormality (F42)

Malfunction Decision Conditions:

During startup and operation of cooling and heating, the temperatures detected by the outdoor pipe temperature sensor are used to determine sensor error.

Malfunction Caused:

- 1 Faulty connector connection.
- 2 Faulty sensor.
- 3 Faulty outdoor unit PCB (main).

Abnormality Judgment:

Continue for 5 seconds.

Troubleshooting:



Caution

For safety reason and to prevent component breakdown, always switch off the power before remove and connect the component.

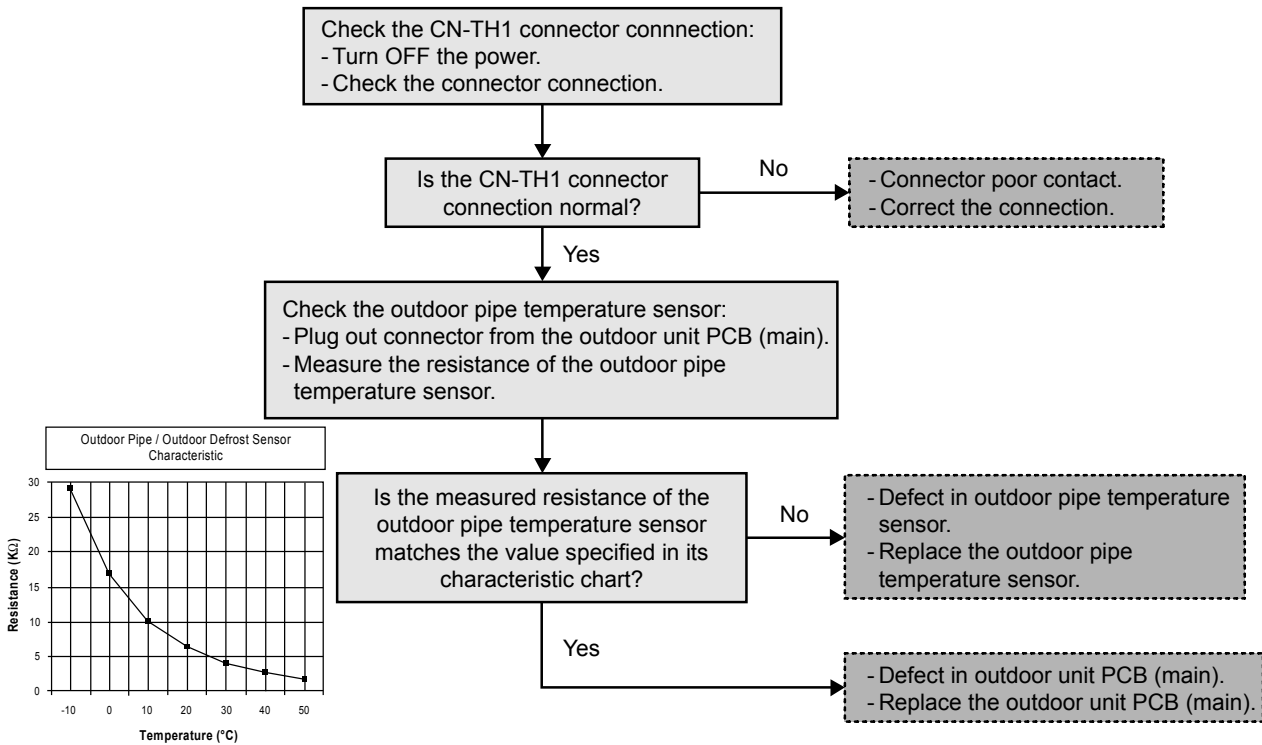

17.5.45 Outdoor Defrost Temperature Sensor Abnormality (F43)

Malfunction Decision Conditions:

During startup and operation of cooling and heating, the temperatures detected by the outdoor defrost temperature sensor are used to determine sensor error.

Malfunction Caused:

- 1 Faulty connector connection.
- 2 Faulty sensor.
- 3 Faulty outdoor unit PCB (main).

Abnormality Judgment:

Continue for 5 seconds.

Troubleshooting:



Caution

For safety reason and to prevent component breakdown, always switch off the power before remove and connect the component.

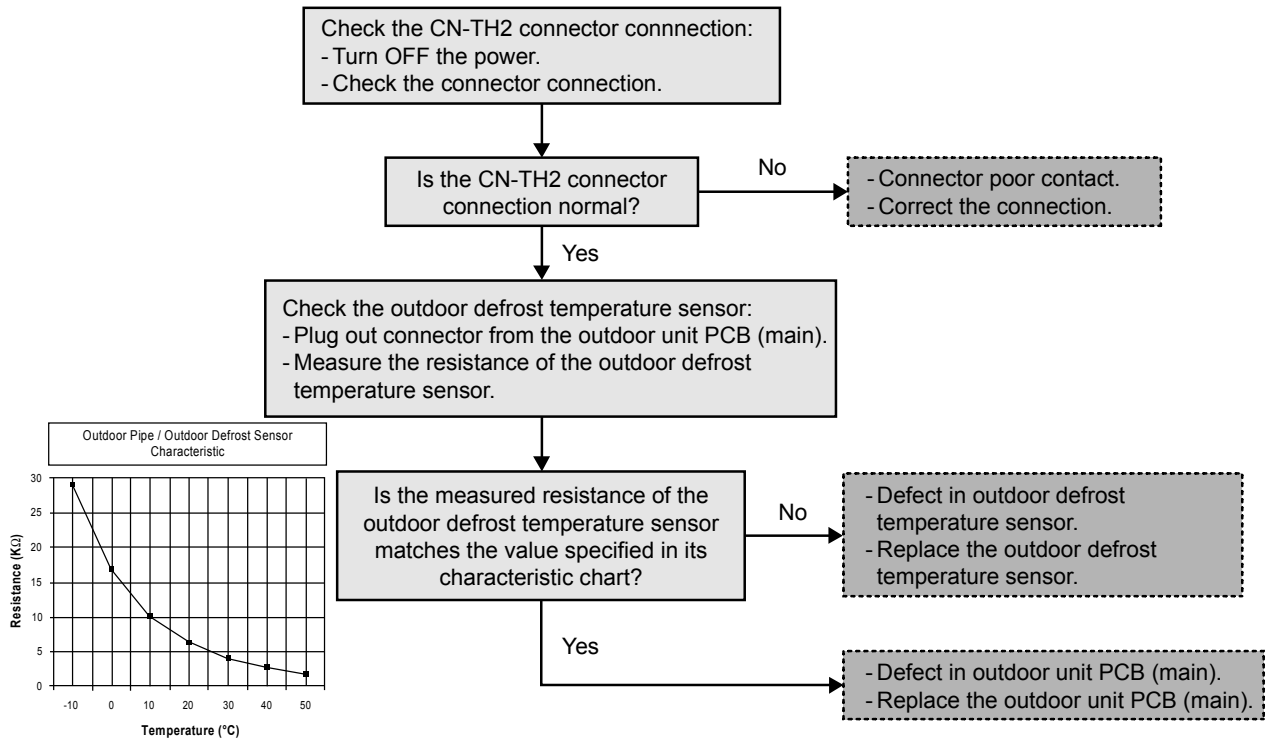

17.5.46 Indoor Water Outlet Temperature Sensor Abnormality (F45)

Malfunction Decision Conditions:

During startup and operation of cooling and heating, the temperatures detected by the indoor water outlet temperature sensor are used to determine sensor errors.

Malfunction Caused:

- 1 Faulty connector connection.
- 2 Faulty sensor.
- 3 Faulty indoor unit PCB (main).

Abnormality Judgment:

Continue for 5 seconds.

Troubleshooting:



Caution

For safety reason and to prevent component breakdown, always switch off the power before remove and connect the component.

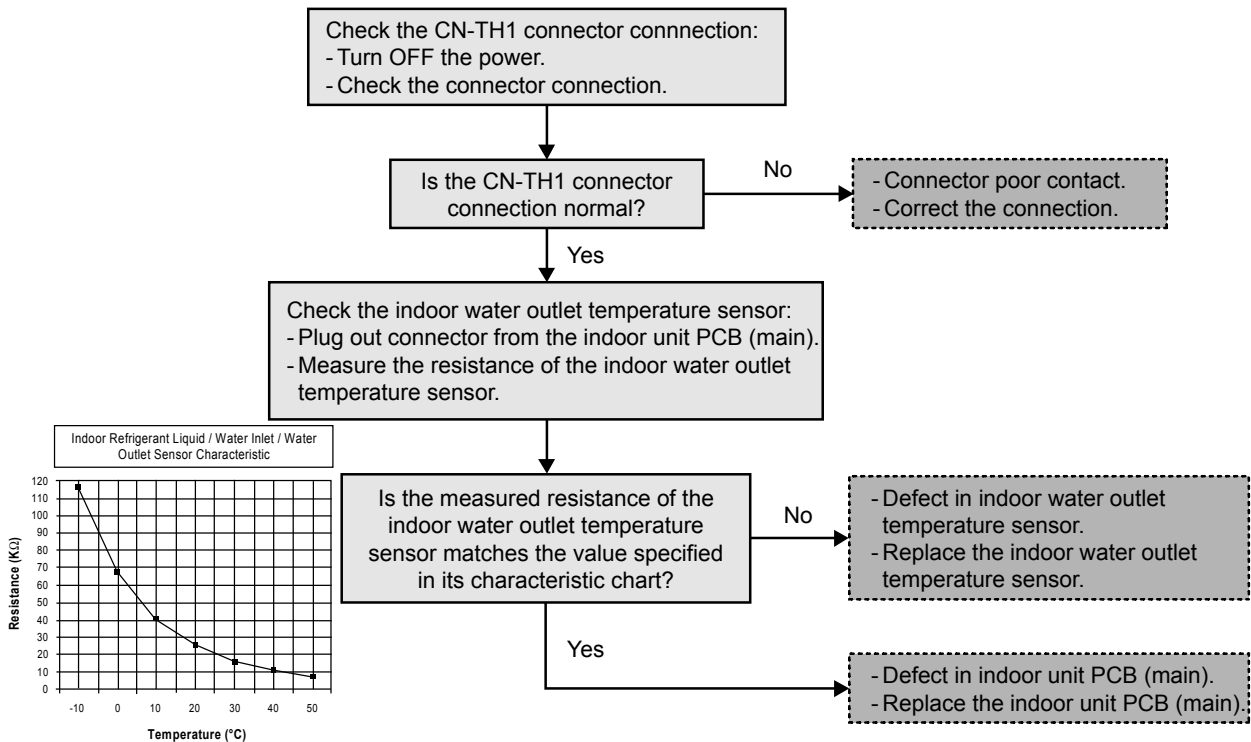

17.5.47 Outdoor Current Transformer Open Circuit (F46)

Malfunction Decision Conditions:

A current transformer (CT) open circuit is detected by checking the compressor running frequency (\geq rated frequency) and CT detected input current (< 0.65 A) for continuously 20 seconds.

Malfunction Caused:

- 1 CT defective.
- 2 Faulty outdoor unit PCB (main).
- 3 Compressor defective (low compression).

Abnormality Judgment:

Continue 3 times in 20 minutes.

Troubleshooting:



Caution

For safety reason and to prevent component breakdown, always switch off the power before remove and connect the component.

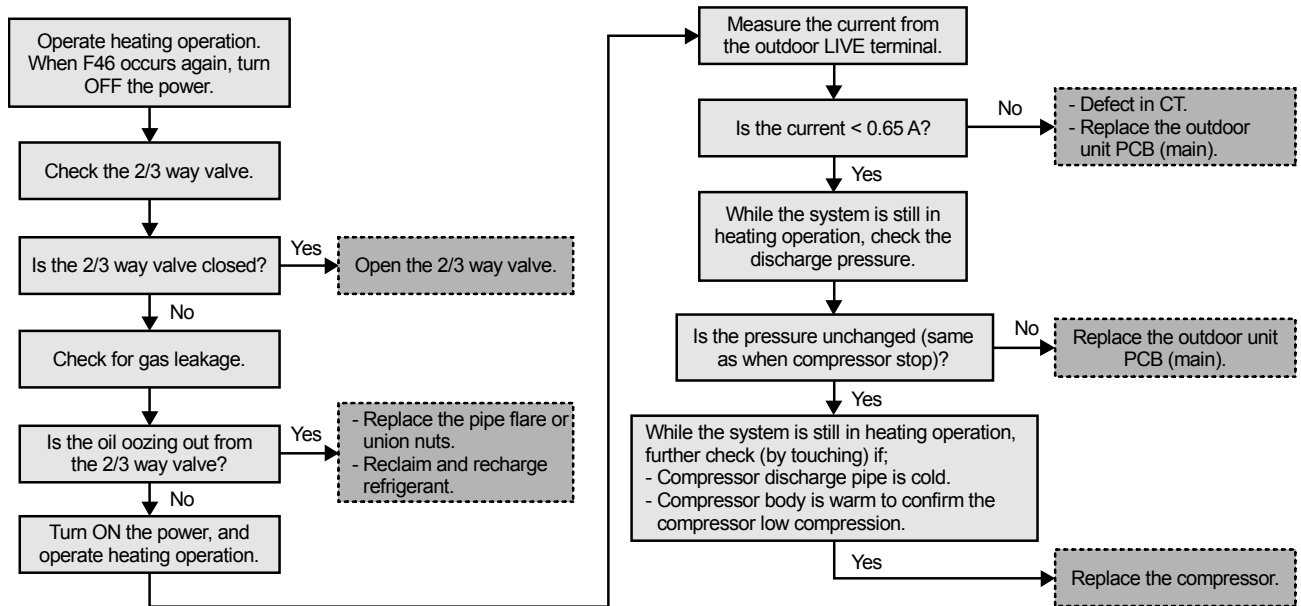

17.5.48 Cooling High Pressure Overload Protection (F95)

Malfunction Decision Conditions:

During operation of cooling, when pressure 4.0 MPa and above is detected by outdoor high pressure sensor.

Malfunction Caused:

- 1 Dust accumulation in the outdoor unit heat exchanger.
- 2 Air short circuit at outdoor unit.
- 3 2 way valve closed.
- 4 Faulty outdoor unit fan motor.
- 5 Clogged expansion valve or strainer.
- 6 Excessive refrigerant.
- 7 Faulty outdoor high pressure sensor.
- 8 Faulty outdoor unit PCB (main).

Troubleshooting:



Caution

For safety reason and to prevent component breakdown, always switch off the power before remove and connect the component.

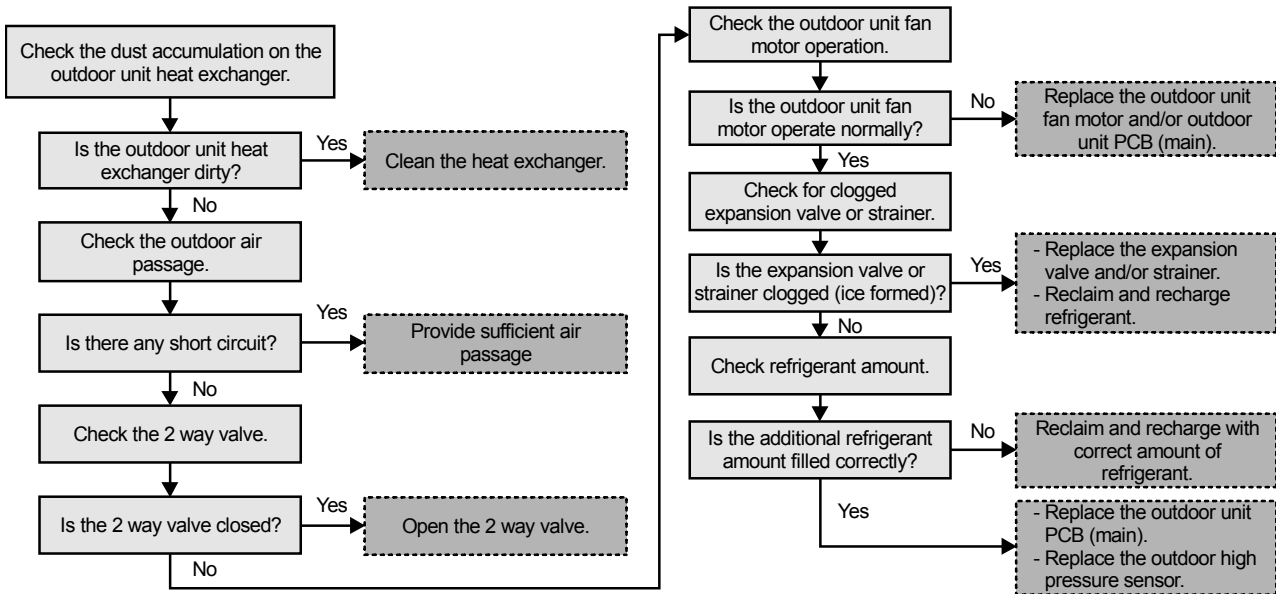

18. Disassembly and Assembly Instructions

 **WARNING**

High Voltage are generated in the electrical parts area by the capacitor. Ensure that the capacitor has discharged sufficiently before proceeding with repair work. Failure to heed this caution may result in electric shocks.

18.1 To Remove Front Plate and Top Plate

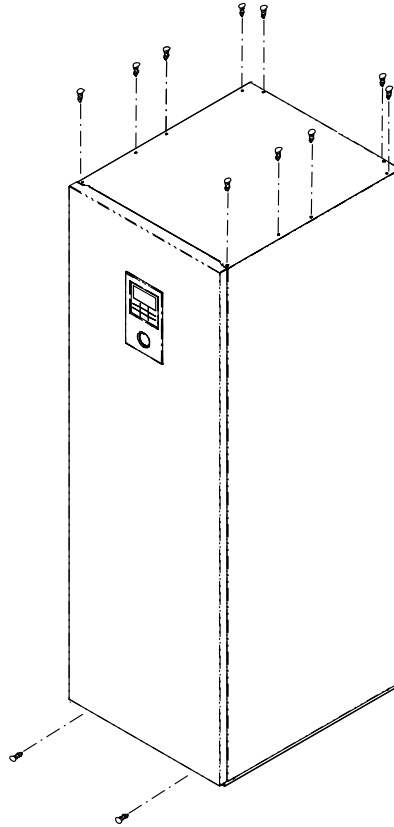

- 1 Remove 2 screws at the bottom to remove the Front Plate.
- 2 Remove 10 screws at the top to remove the Top Plate.

18.2 To Remove Pressure Gauge

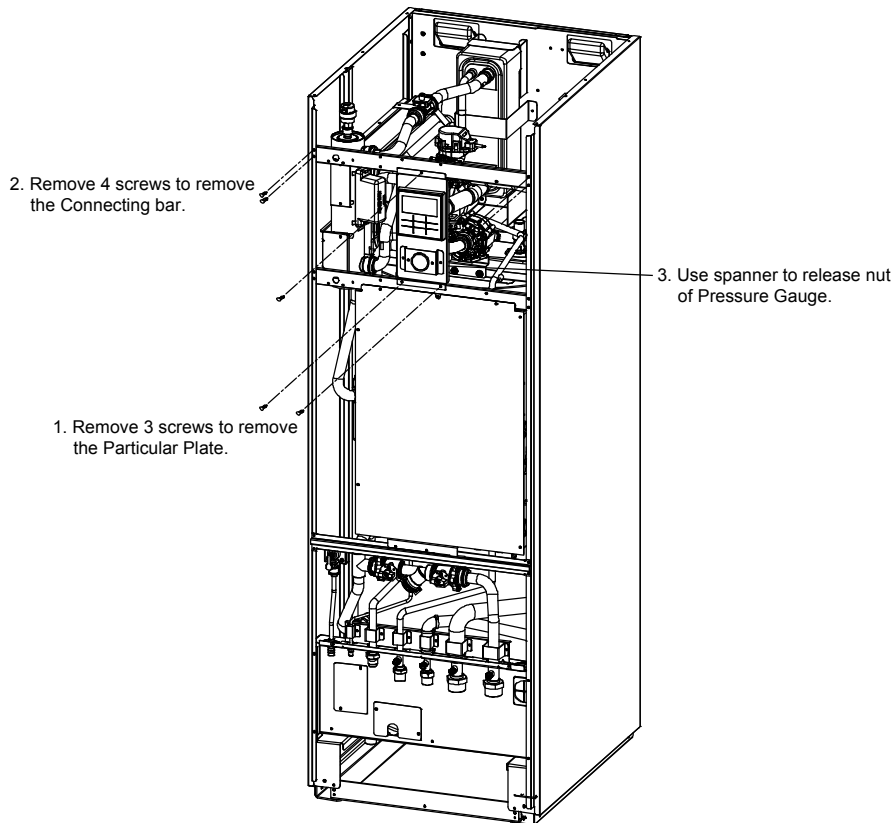

18.3 To Remove Remote Control

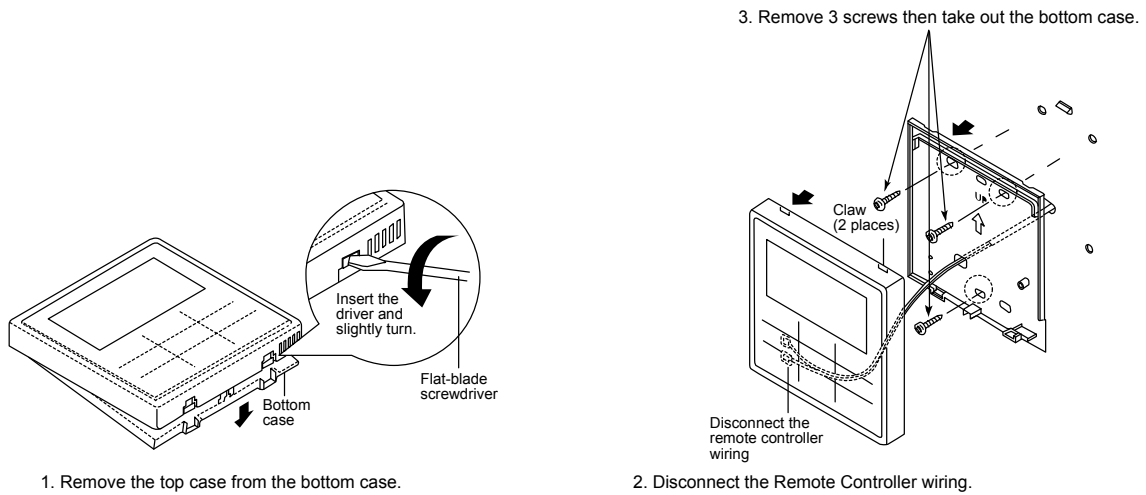

18.4 To Remove RCCB

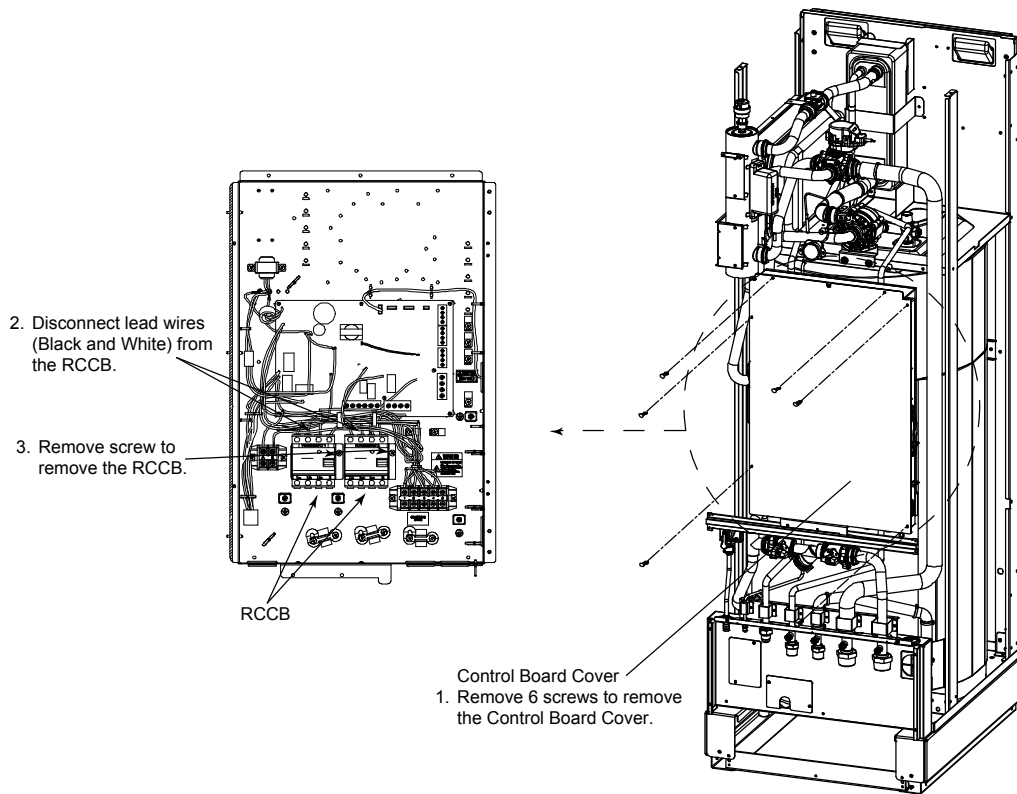

18.5 To Remove Electronic Controller

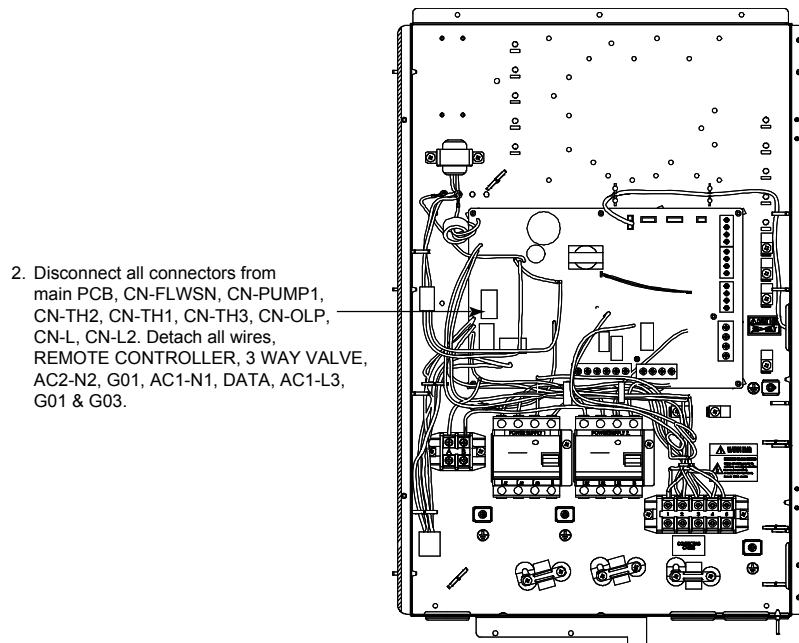

18.6 To Remove Flow Switch and Air Purge Valve

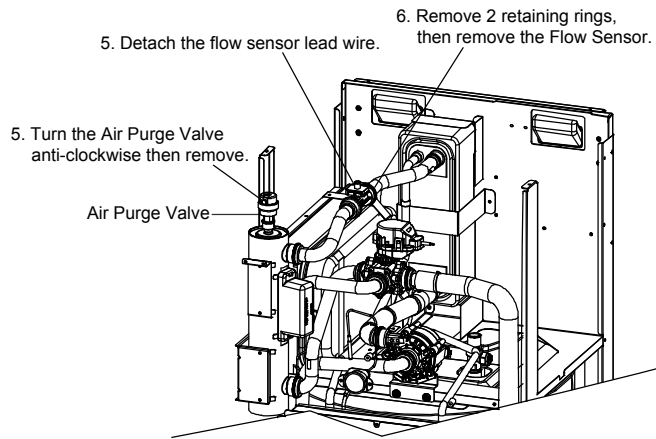

⚠ When reinstall Flow Switch, ensure the arrow on the flow switch is parallel with the pipe shaft and is facing in the direction of flow.

⚠ During reinstall Air Purge Valve.

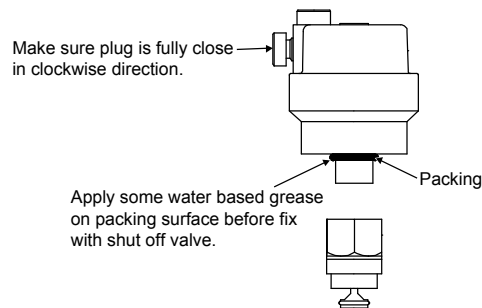

18.7 To Remove Water Pump

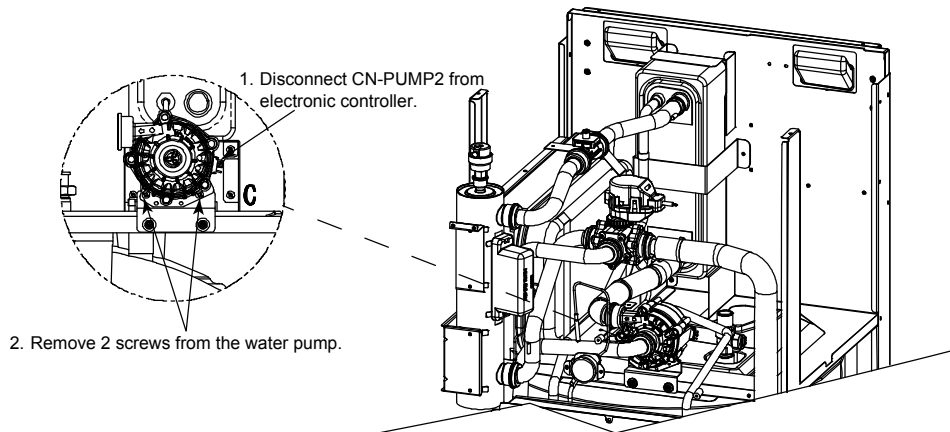

18.8 To Remove Bottle Complete

1. Disconnect the connector CN_OLP1 from the Electronic Controller and detached the lead wire HT1-L3 (Red) and AC2-L3 (Black).

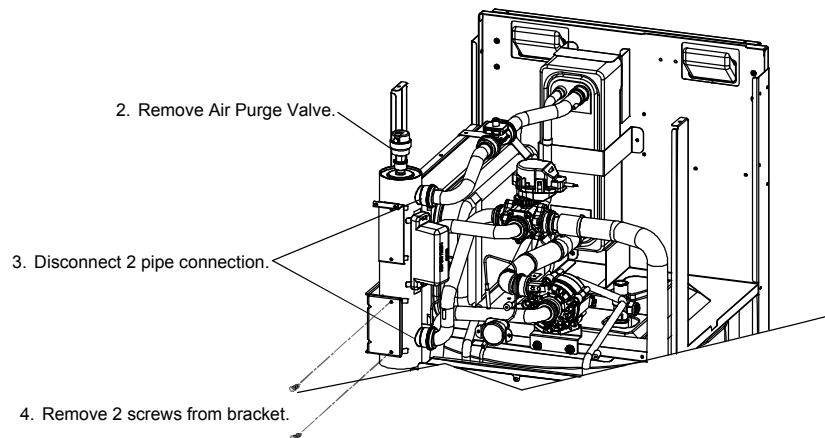

18.9 To Remove Water Filter

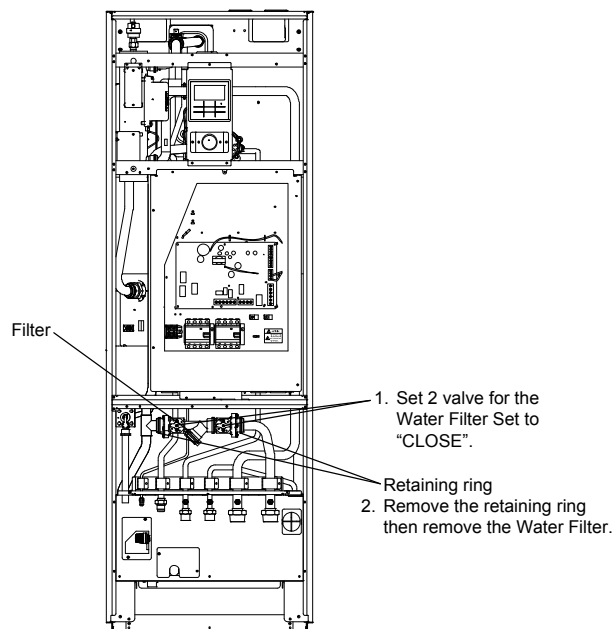

19. Technical Data

19.1 Operation Characteristics

19.1.1 WH-ADC0916H9E8 WH-UQ09HE8

Heating Characteristics at Different Outdoor Air Temperature

Condition

Outdoor air temperature : 7°C (DBT), 6°C (WBT)

Indoor water inlet temperature : 30°C

Indoor water outlet temperature : 35°C

Piping length : 7 m

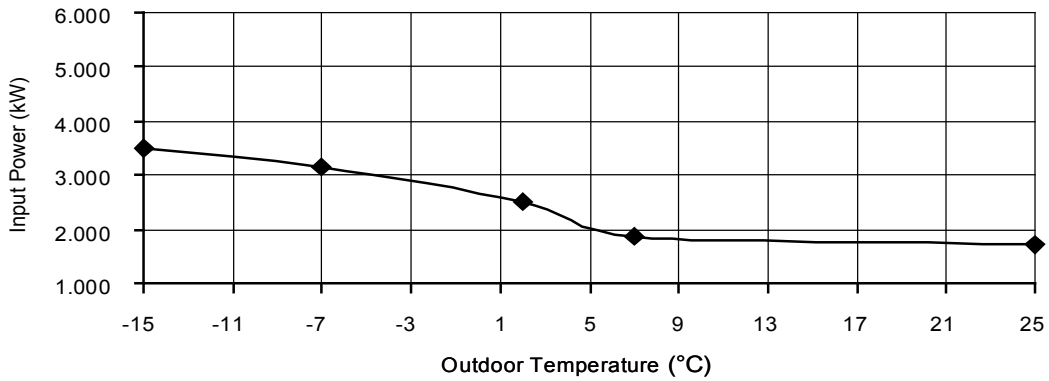
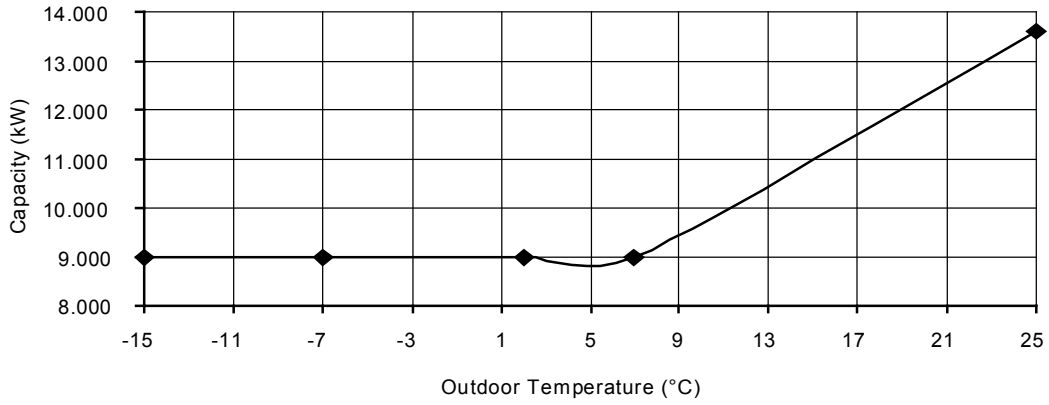

Cooling Characteristics at Different Outdoor Air Temperature

Condition

Outdoor air temperature : 35°C (DBT), -°C (WBT)

Indoor water inlet temperature : 12°C

Indoor water outlet temperature : 7°C

Piping length : 7 m

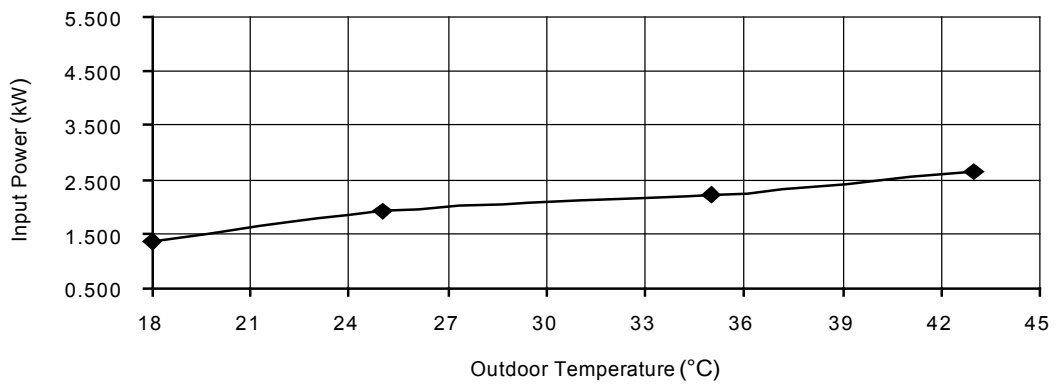
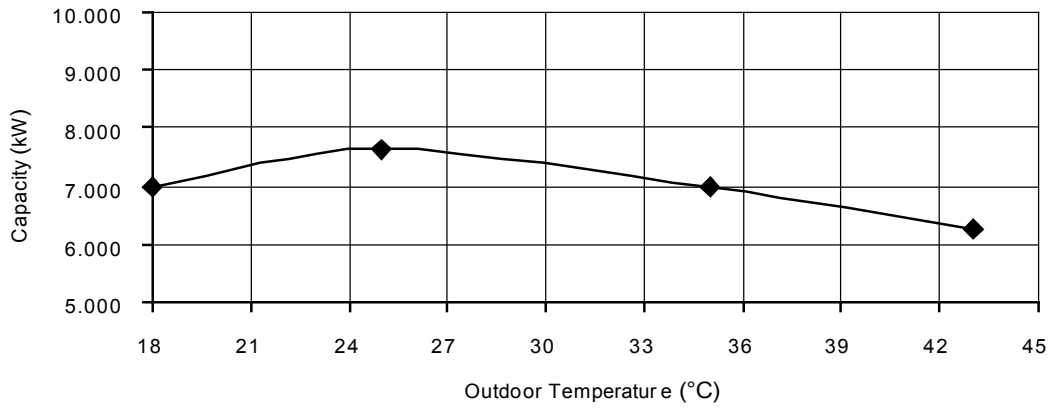

Heating Characteristics at Different Piping Length

Condition

Outdoor air temperature : 7°C (DBT), 6°C (WBT)

Indoor water inlet temperature : 30°C

Indoor water outlet temperature : 35°C

Piping length : 7 m

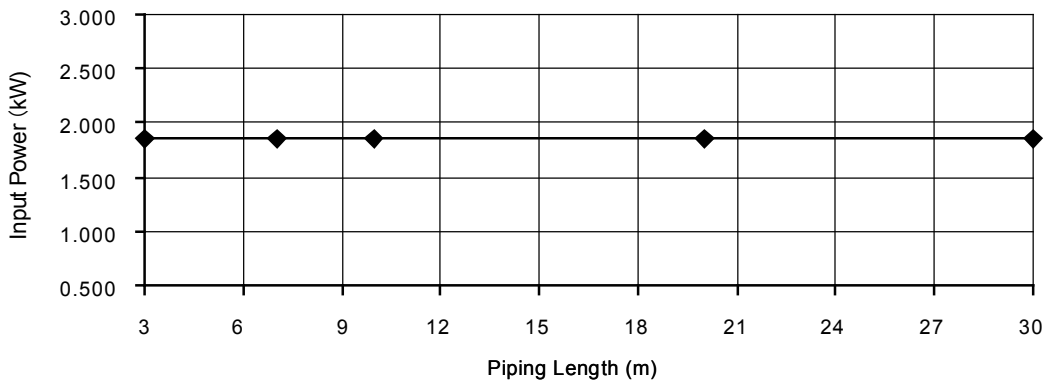
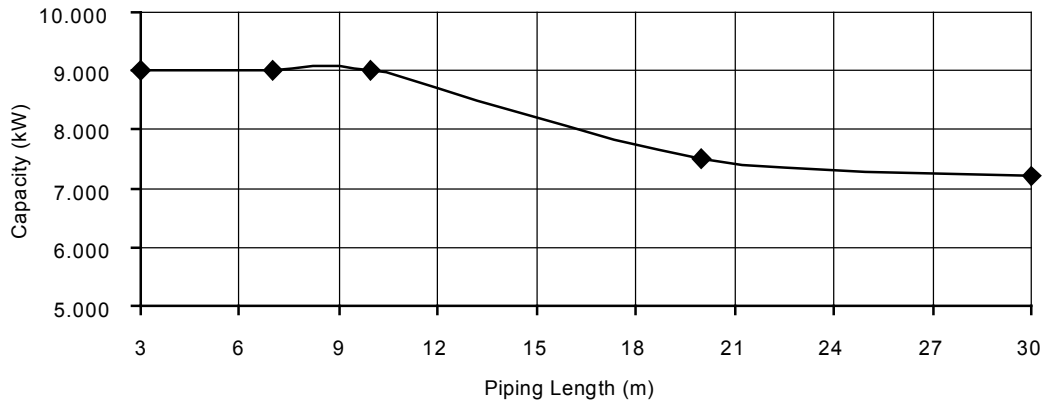

Cooling Characteristics at Different Piping Length

Condition

Outdoor air temperature : 35°C (DBT), -°C (WBT)

Indoor water inlet temperature : 12°C

Indoor water outlet temperature : 7°C

Piping length : 7 m

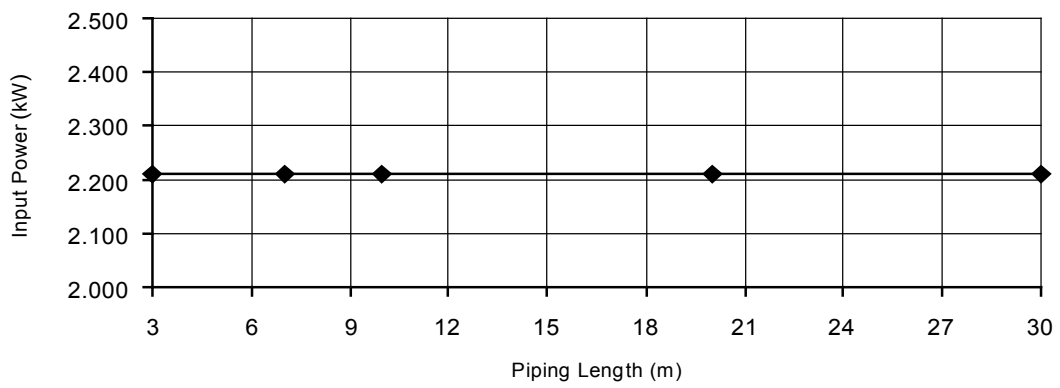
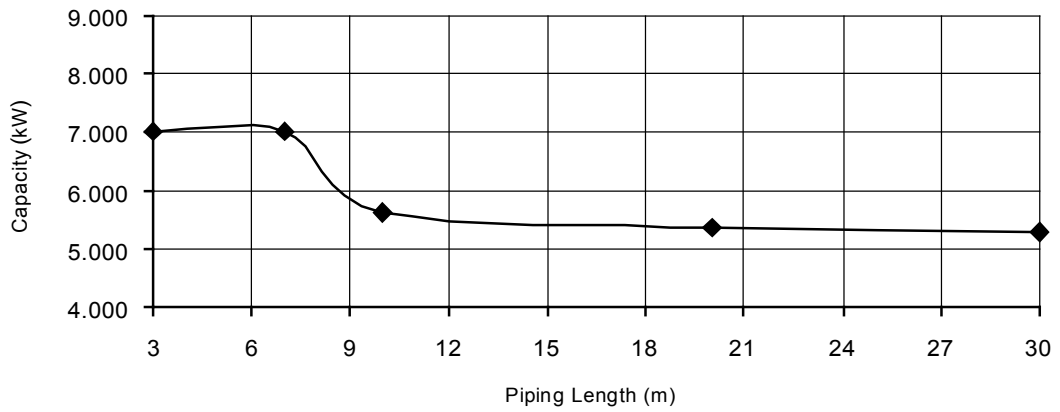

19.1.2 WH-ADC0916H9E8 WH-UQ12HE8

Heating Characteristics at Different Outdoor Air Temperature

Condition

Outdoor air temperature : 7°C (DBT), 6°C (WBT)

Indoor water inlet temperature : 30°C

Indoor water outlet temperature : 35°C

Piping length : 7 m

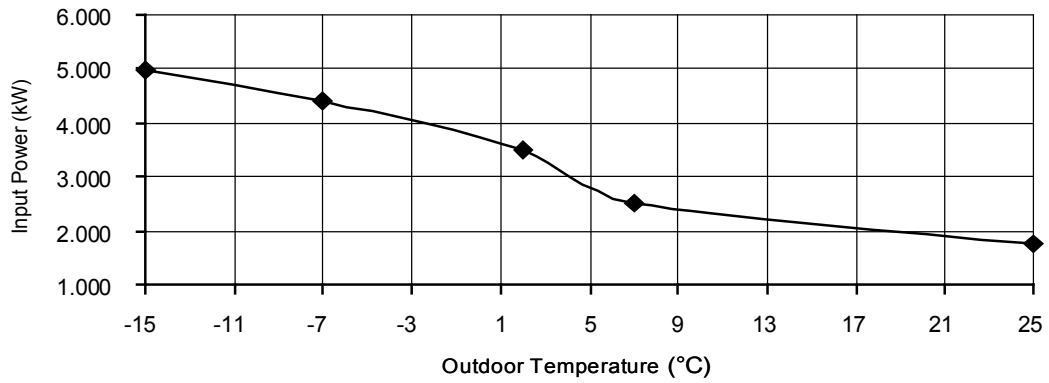
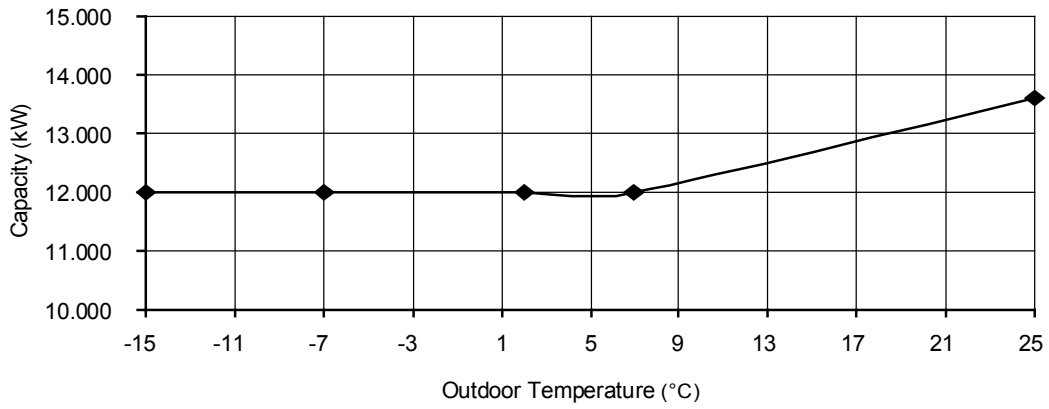

Cooling Characteristics at Different Outdoor Air Temperature

Condition

Outdoor air temperature : 35°C (DBT), -°C (WBT)

Indoor water inlet temperature : 12°C

Indoor water outlet temperature : 7°C

Piping length : 7 m

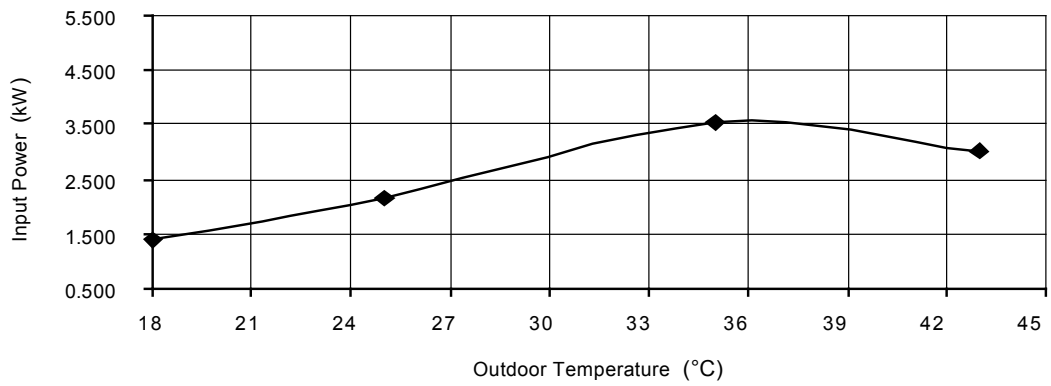
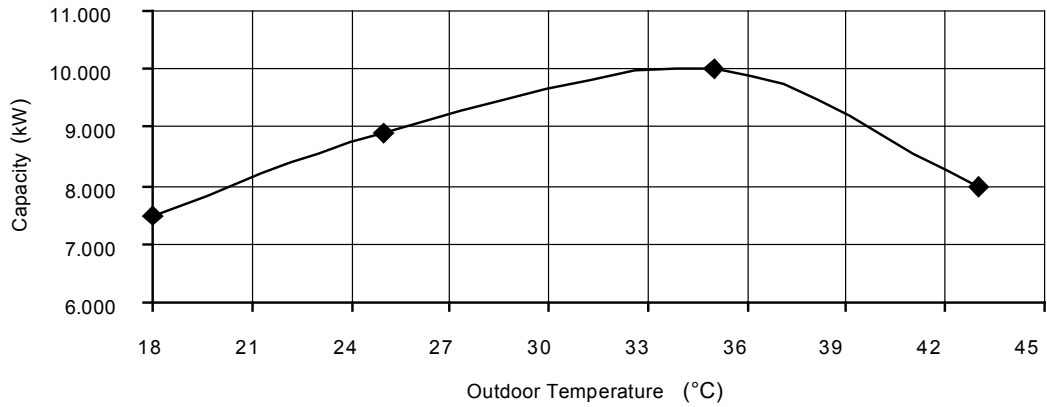

Heating Characteristics at Different Piping Length

Condition

Outdoor air temperature : 7°C (DBT), 6°C (WBT)

Indoor water inlet temperature : 30°C

Indoor water outlet temperature : 35°C

Piping length : 7 m

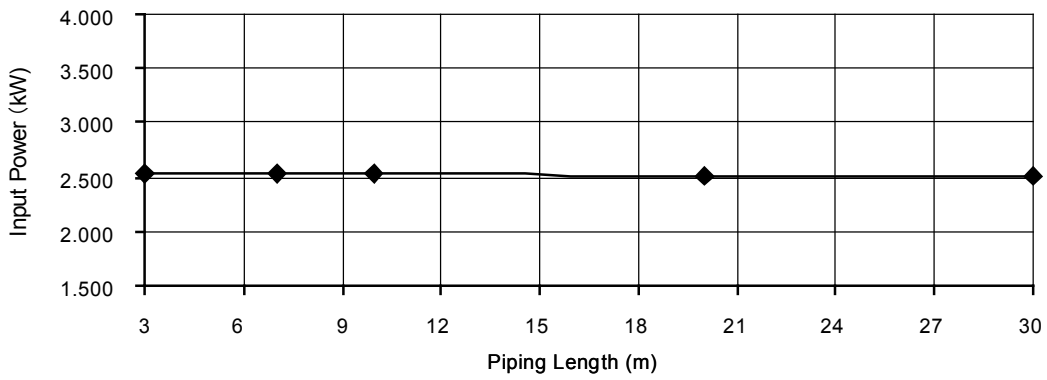
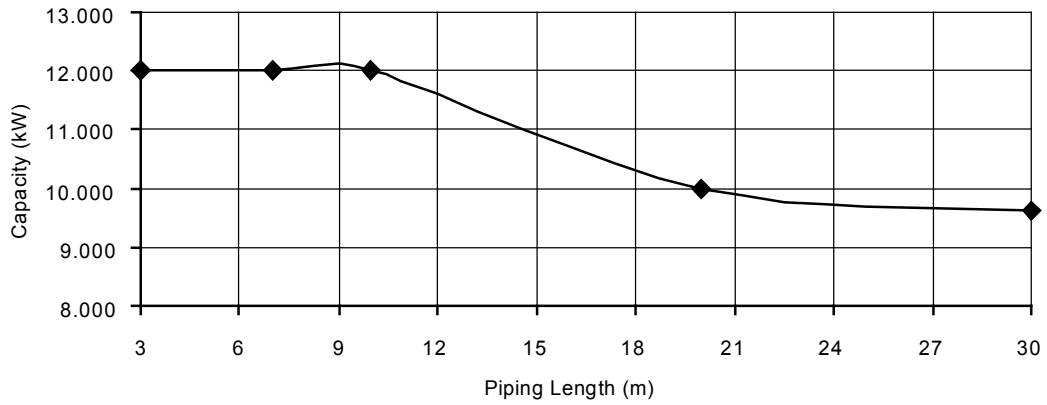

Cooling Characteristics at Different Piping Length

Condition

Outdoor air temperature : 35°C (DBT), -°C (WBT)

Indoor water inlet temperature : 12°C

Indoor water outlet temperature : 7°C

Piping length : 7 m

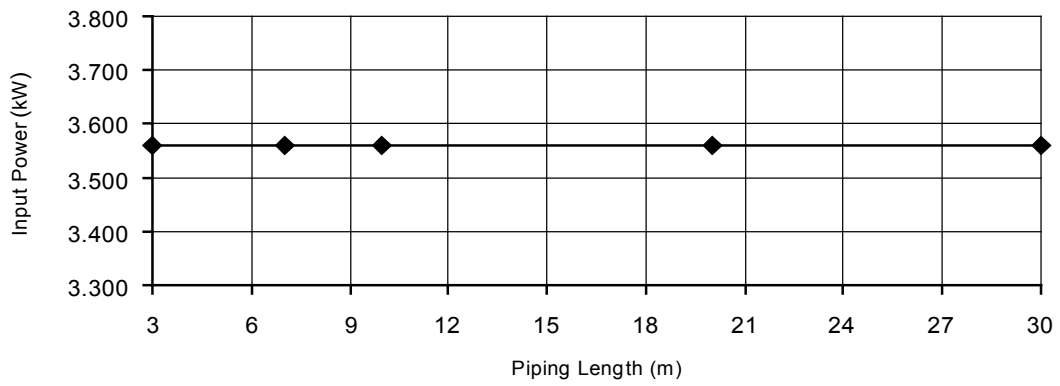
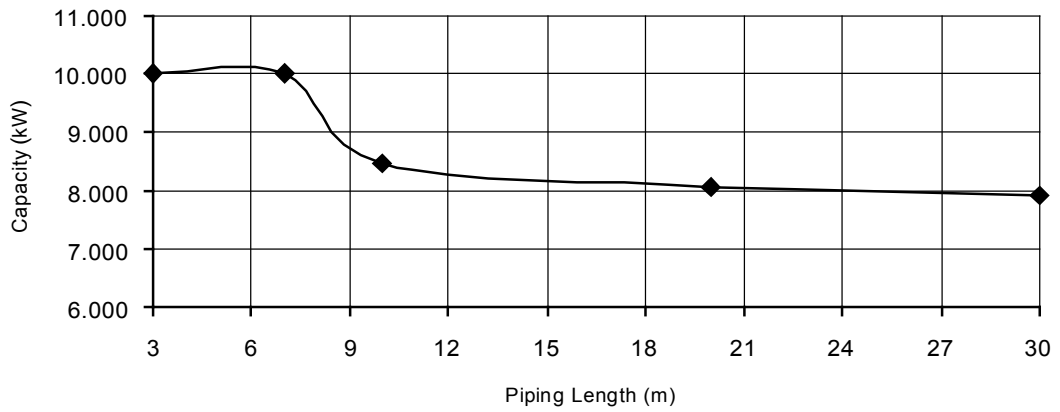

19.1.3 WH-ADC0916H9E8 WH-UQ16HE8

Heating Characteristics at Different Outdoor Air Temperature

Condition

Outdoor air temperature : 7°C (DBT), 6°C (WBT)

Indoor water inlet temperature : 30°C

Indoor water outlet temperature : 35°C

Piping length : 7 m

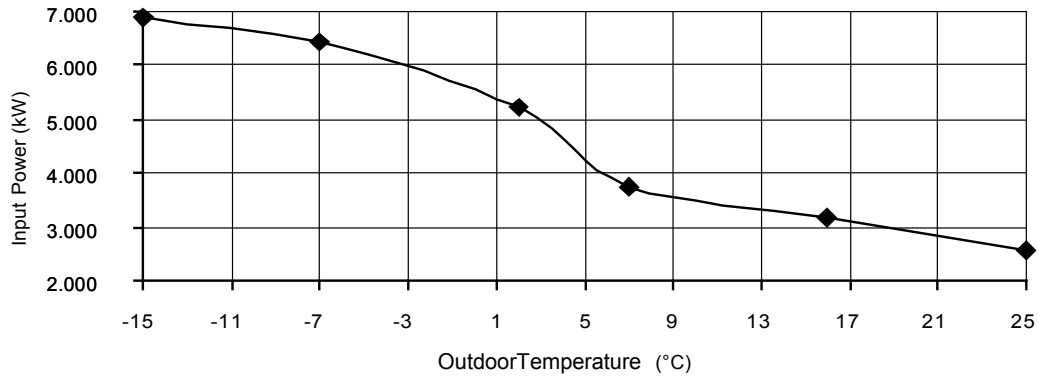
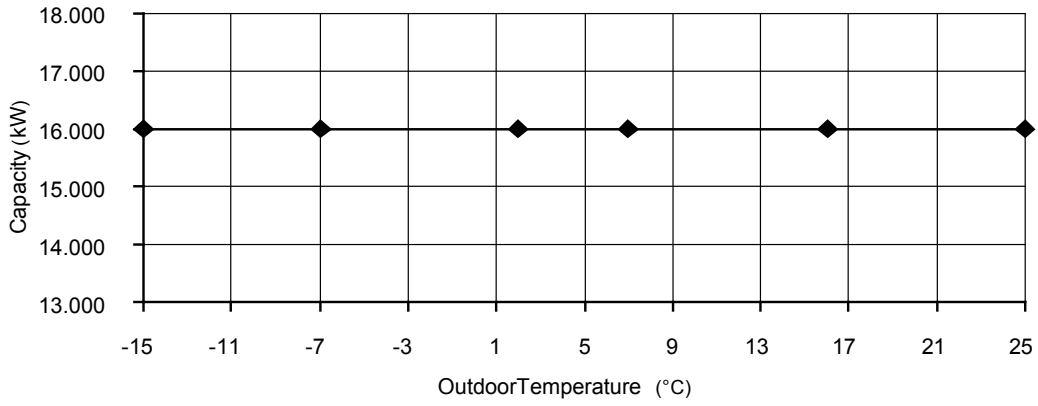

Cooling Characteristics at Different Outdoor Air Temperature

Condition

Outdoor air temperature : 35°C (DBT), -°C (WBT)

Indoor water inlet temperature : 12°C

Indoor water outlet temperature : 7°C

Piping length : 7 m

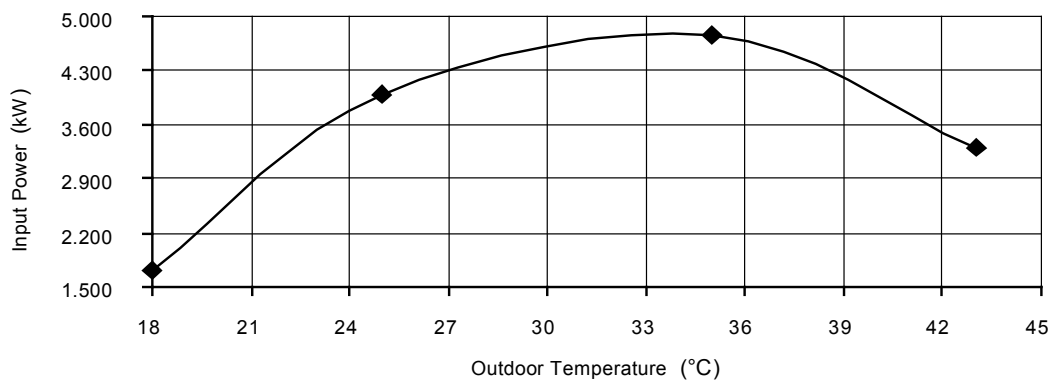
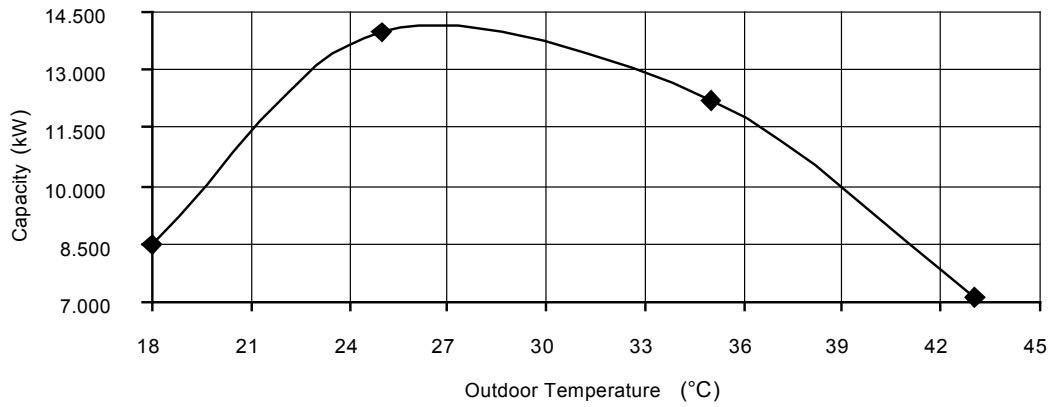

Cooling Characteristics at Different Outdoor Air Temperature

Condition

Outdoor air temperature : 35°C (DBT), -°C (WBT)

Indoor water inlet temperature : 12°C

Indoor water outlet temperature : 18°C

Piping length : 7 m

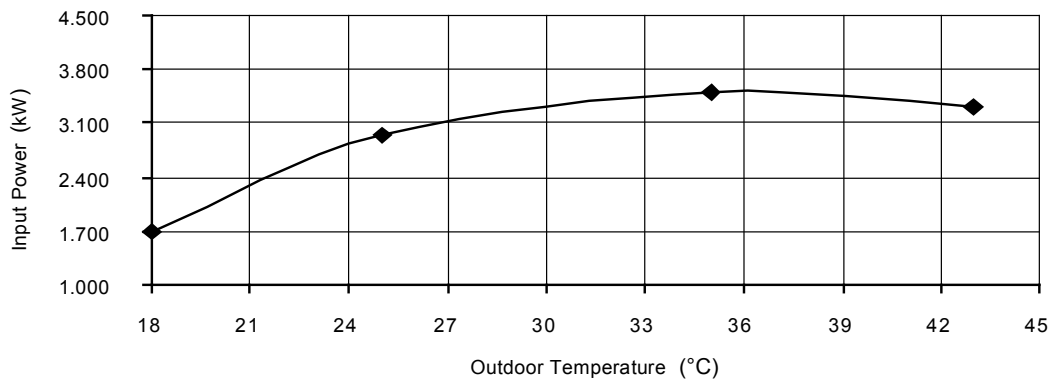
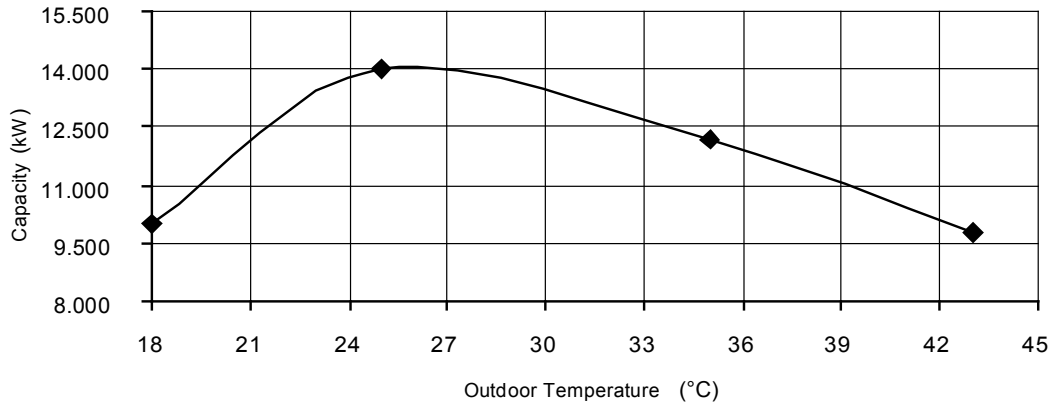

Heating Characteristics at Different Piping Length

Condition

Outdoor air temperature : 7°C (DBT), 6°C (WBT)

Indoor water inlet temperature : 30°C

Indoor water outlet temperature : 35°C

Piping length : 7 m

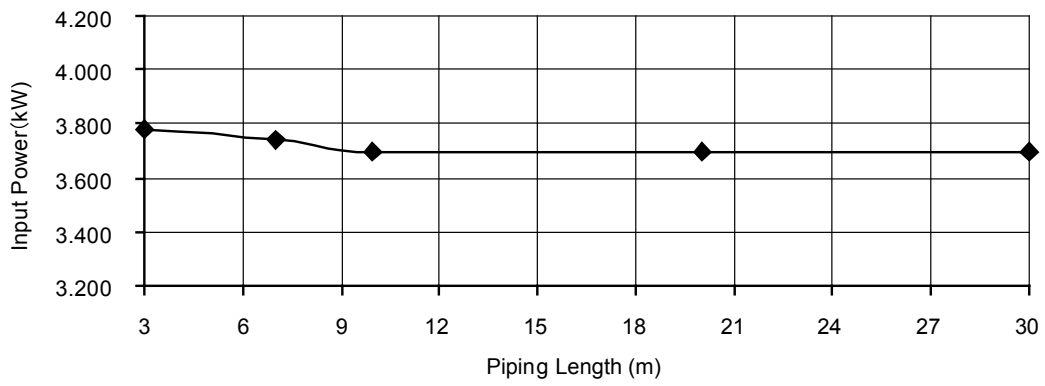
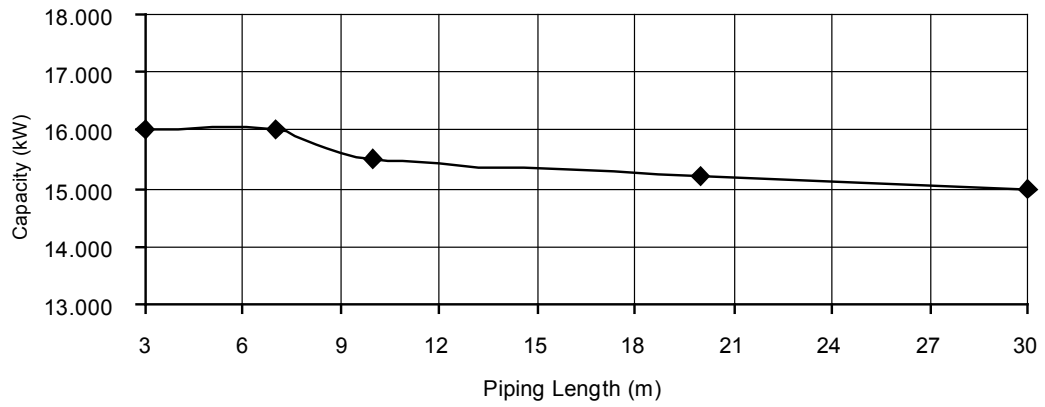

Cooling Characteristics at Different Piping Length

Condition

Outdoor air temperature : 35°C (DBT), -°C (WBT)

Indoor water inlet temperature : 12°C

Indoor water outlet temperature : 7°C

Piping length : 7 m

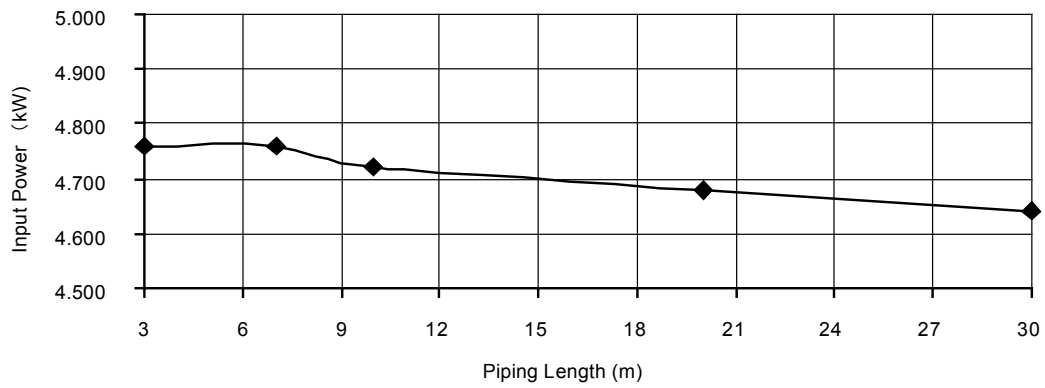
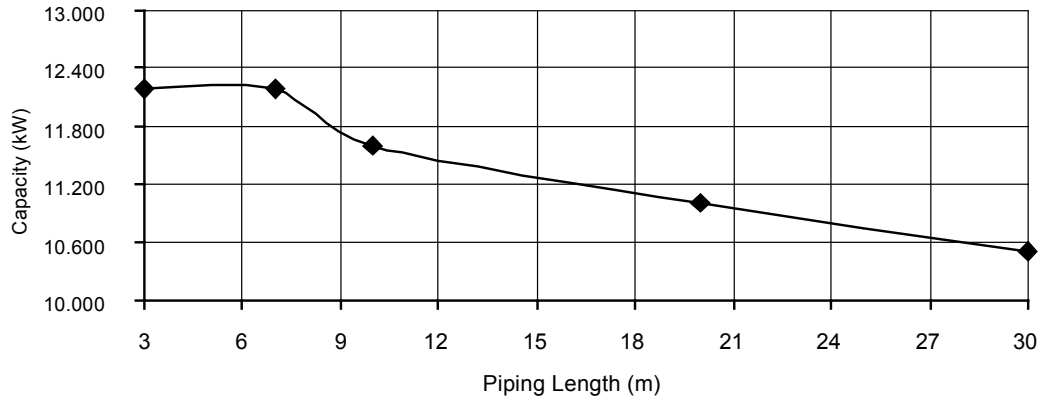

19.1.4 WH-ADC0916H9E8 WH-UX09HE8

Heating Characteristics at Different Outdoor Air Temperature

Condition

Outdoor air temperature : 7°C (DBT), 6°C (WBT)

Indoor water inlet temperature : 30°C

Indoor water outlet temperature : 35°C

Piping length : 7 m

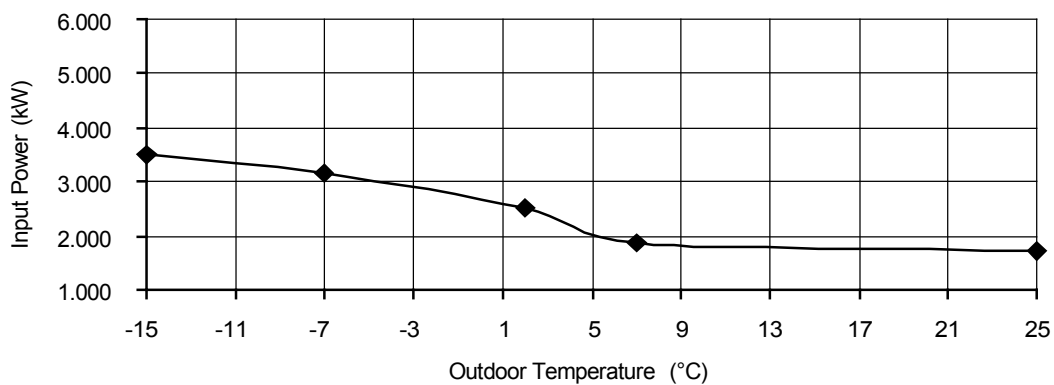
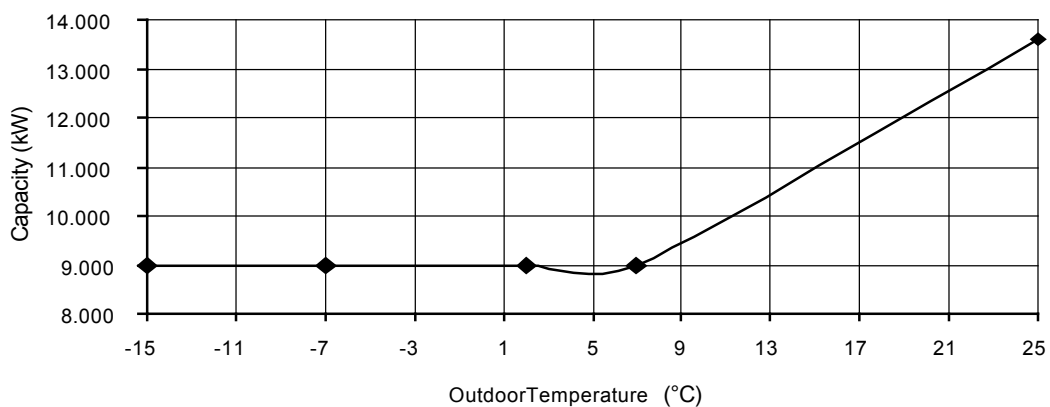

Cooling Characteristics at Different Outdoor Air Temperature

Condition

Outdoor air temperature : 35°C (DBT), -°C (WBT)

Indoor water inlet temperature : 12°C

Indoor water outlet temperature : 7°C

Piping length : 7 m

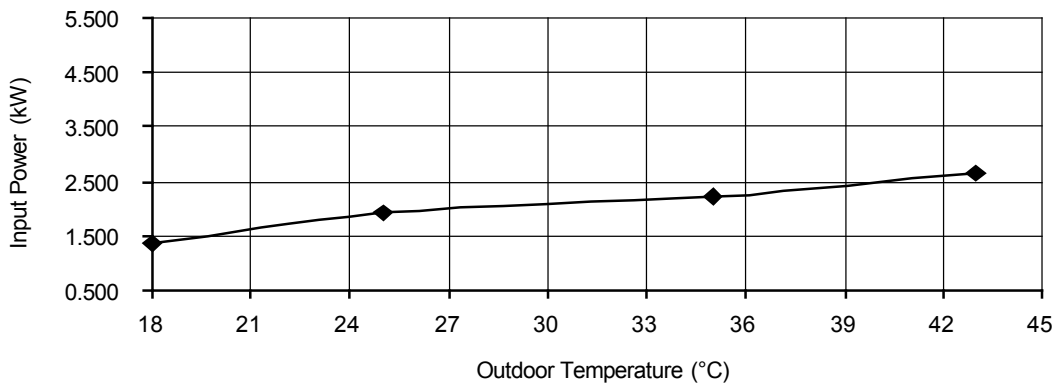
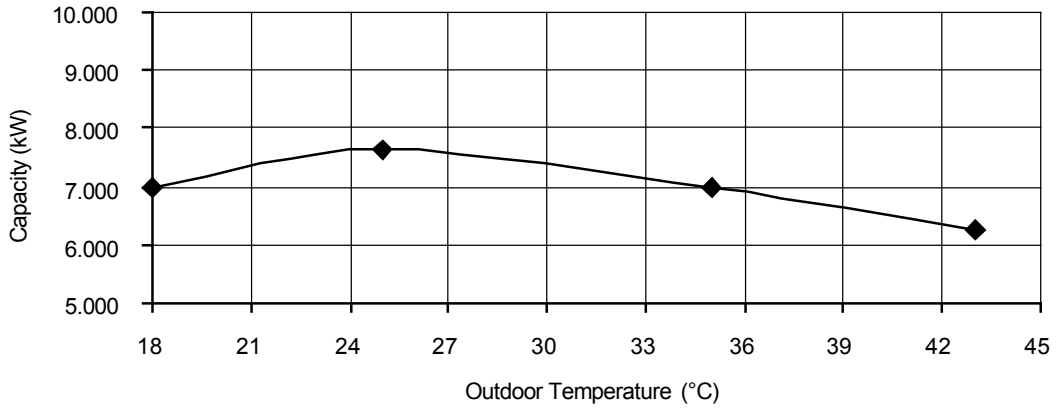

Heating Characteristics at Different Piping Length

Condition

Outdoor air temperature : 7°C (DBT), 6°C (WBT)

Indoor water inlet temperature : 30°C

Indoor water outlet temperature : 35°C

Piping length : 7 m

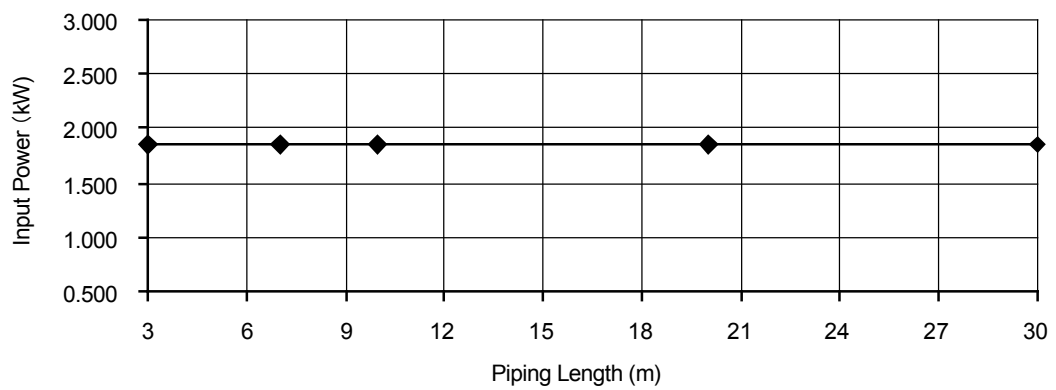
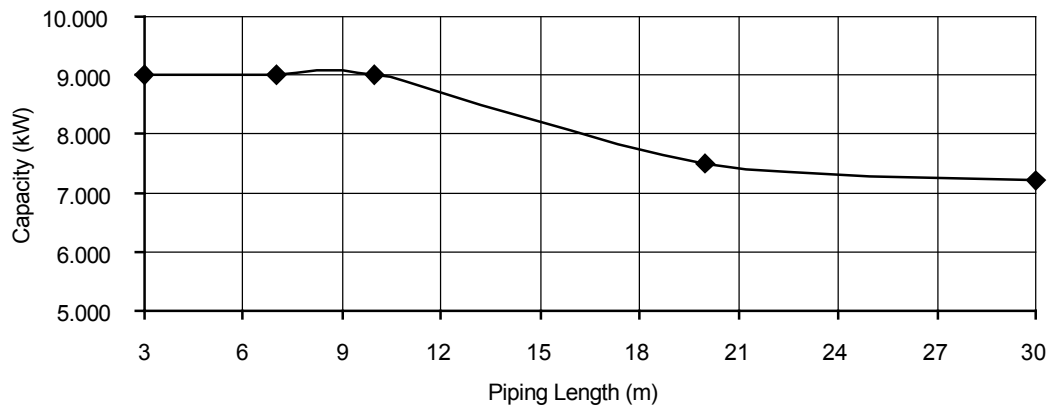

Cooling Characteristics at Different Piping Length

Condition

Outdoor air temperature : 35°C (DBT), -°C (WBT)

Indoor water inlet temperature : 12°C

Indoor water outlet temperature : 7°C

Piping length : 7 m

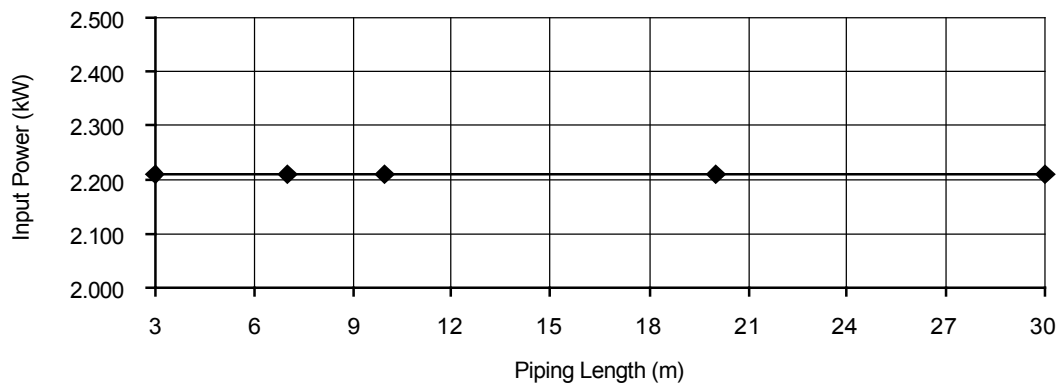
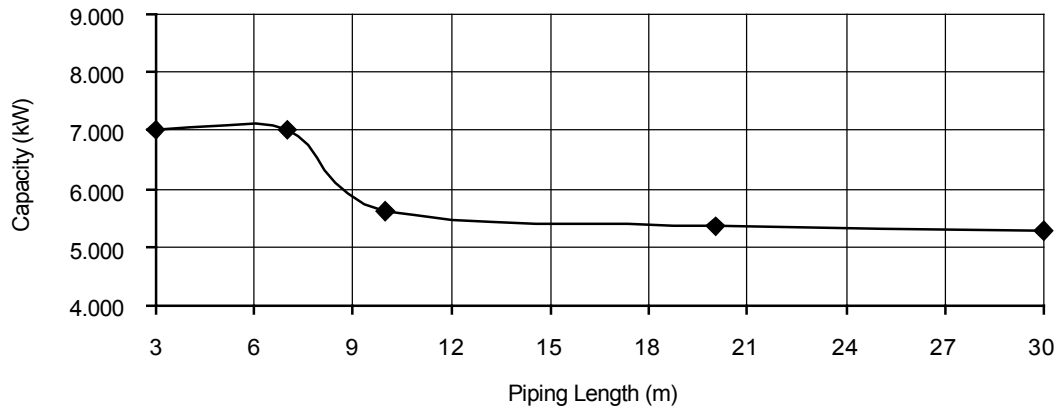

19.1.5 WH-ADC0916H9E8 WH-UX12HE8

Heating Characteristics at Different Outdoor Air Temperature

Condition

Outdoor air temperature : 7°C (DBT), 6°C (WBT)

Indoor water inlet temperature : 30°C

Indoor water outlet temperature : 35°C

Piping length : 7 m

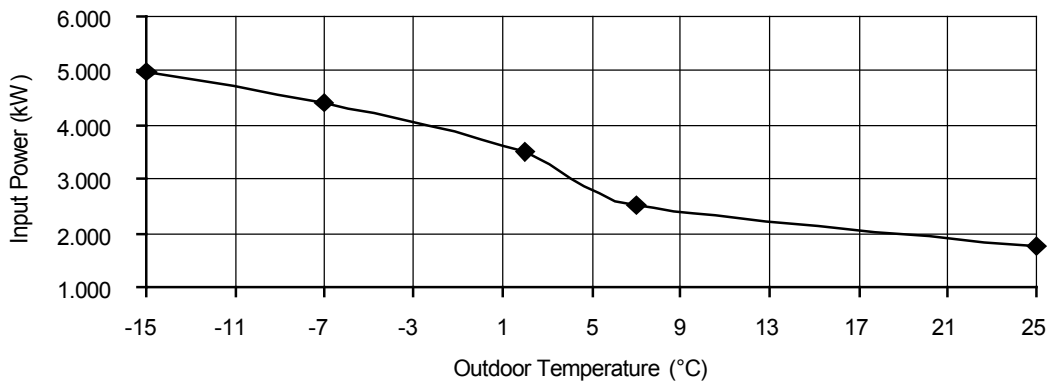
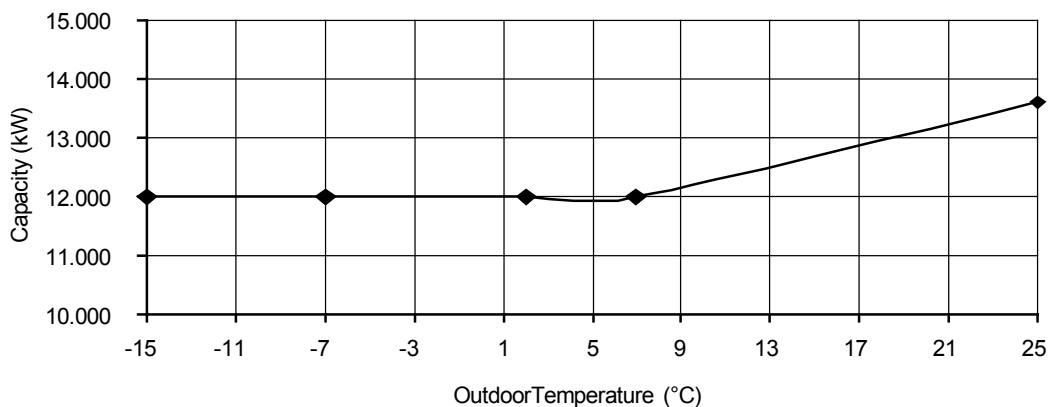

Cooling Characteristics at Different Outdoor Air Temperature

Condition

Outdoor air temperature : 35°C (DBT), -°C (WBT)

Indoor water inlet temperature : 12°C

Indoor water outlet temperature : 7°C

Piping length : 7 m

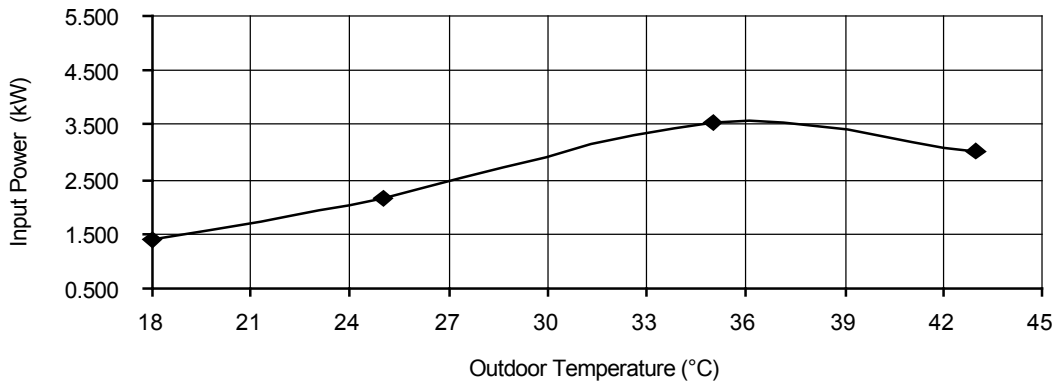
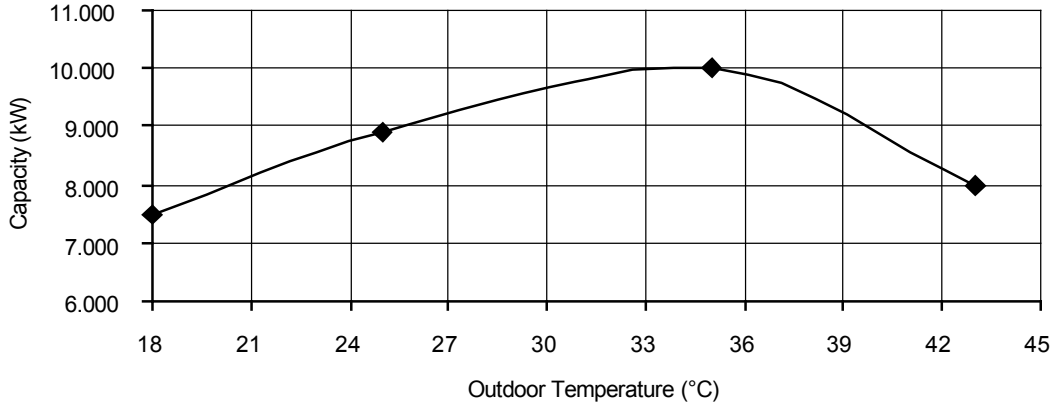

Heating Characteristics at Different Piping Length

Condition

Outdoor air temperature : 7°C (DBT), 6°C (WBT)

Indoor water inlet temperature : 30°C

Indoor water outlet temperature : 35°C

Piping length : 7 m

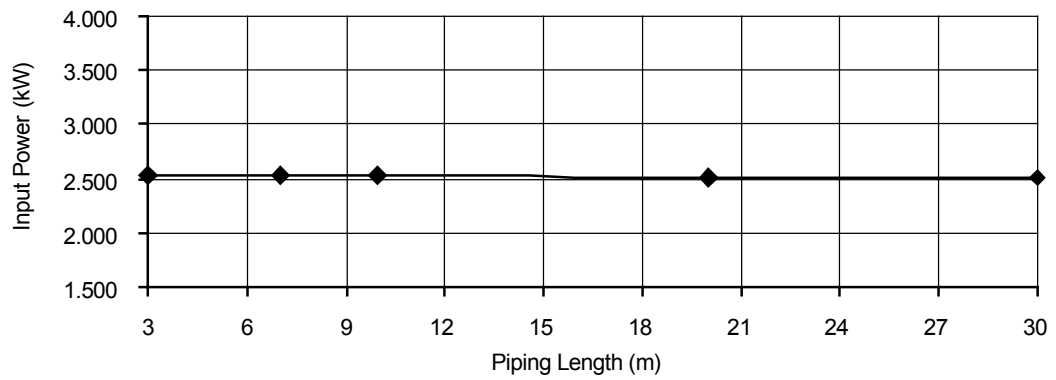
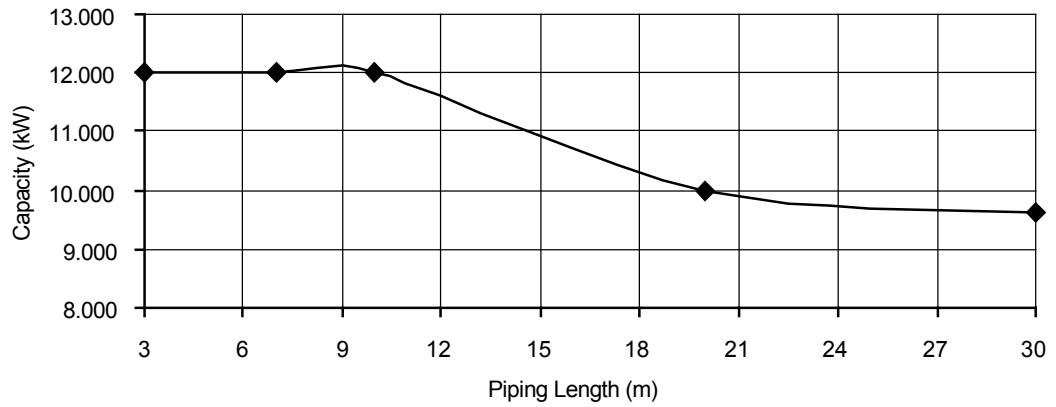

Cooling Characteristics at Different Piping Length

Condition

Outdoor air temperature : 35°C (DBT), -°C (WBT)

Indoor water inlet temperature : 12°C

Indoor water outlet temperature : 7°C

Piping length : 7 m

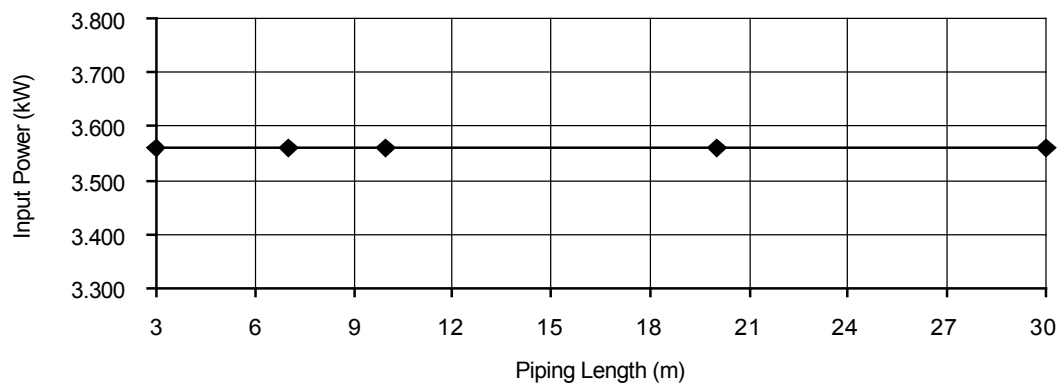
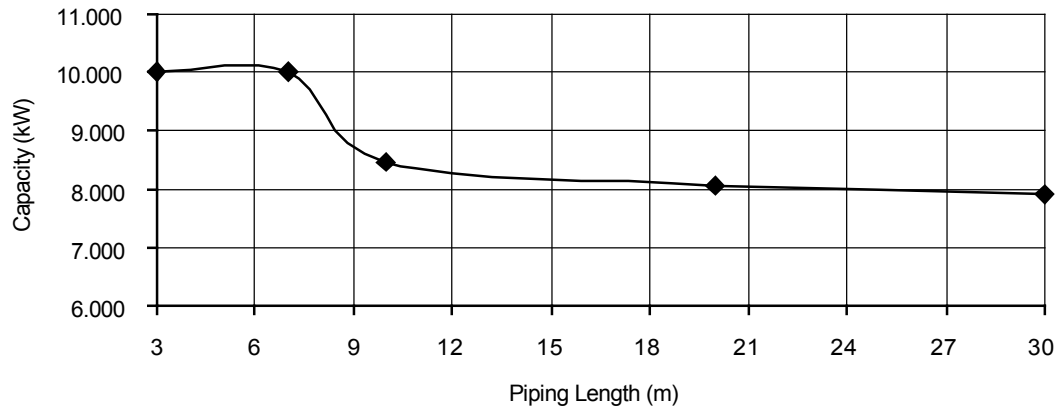

19.1.6 WH-ADC0916H9E8 WH-UX16HE8

Heating Characteristics at Different Outdoor Air Temperature

Condition

Outdoor air temperature : 7°C (DBT), 6°C (WBT)

Indoor water inlet temperature : 30°C

Indoor water outlet temperature : 35°C

Piping length : 7 m

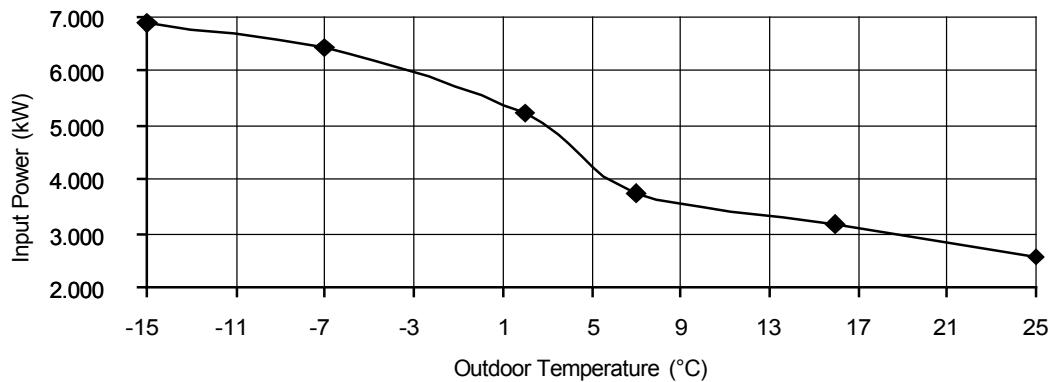
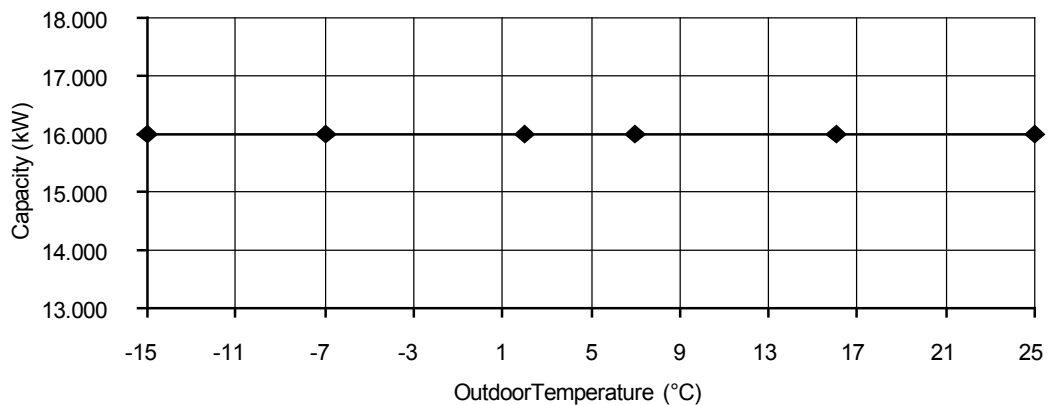

Cooling Characteristics at Different Outdoor Air Temperature

Condition

Outdoor air temperature : 35°C (DBT), -°C (WBT)

Indoor water inlet temperature : 12°C

Indoor water outlet temperature : 7°C

Piping length : 7 m

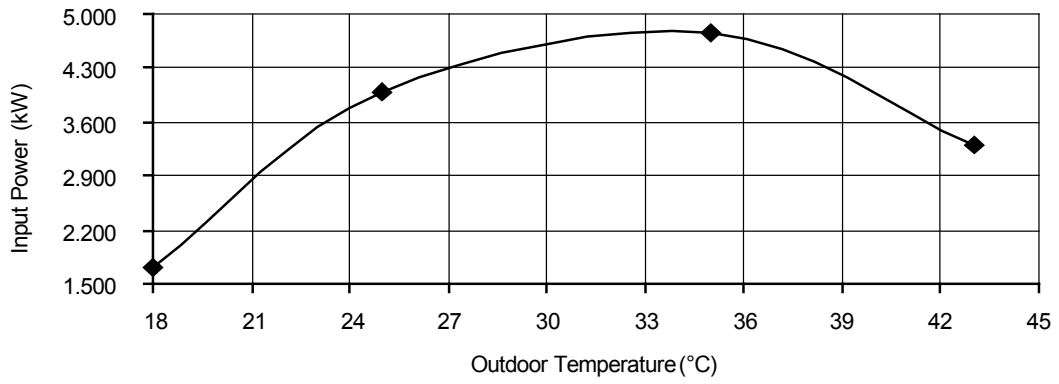
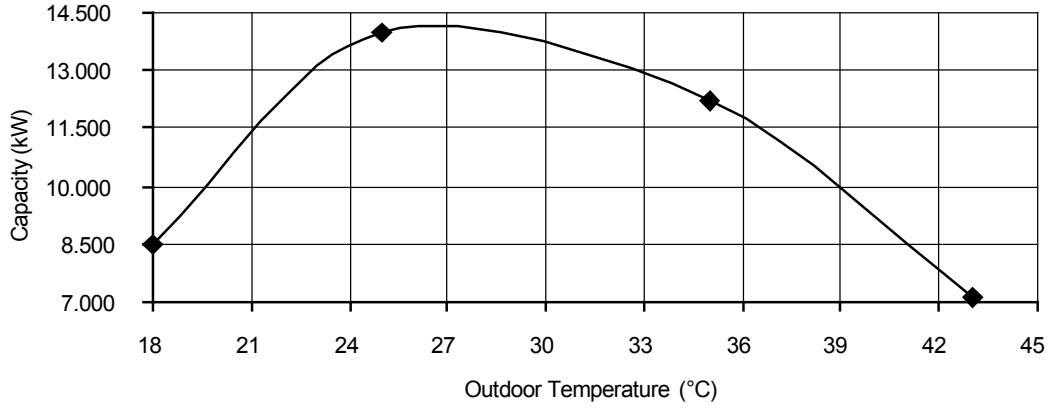

Cooling Characteristics at Different Outdoor Air Temperature

Condition

Outdoor air temperature : 35°C (DBT), -°C (WBT)

Indoor water inlet temperature : 12°C

Indoor water outlet temperature : 18°C

Piping length : 7 m

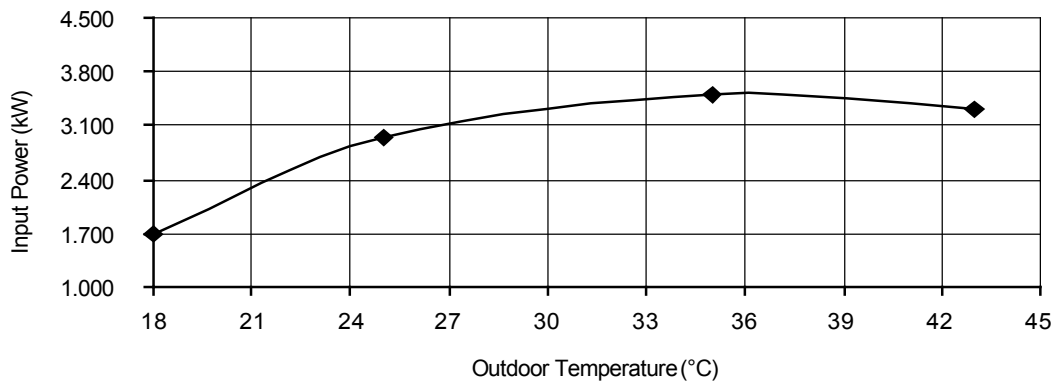
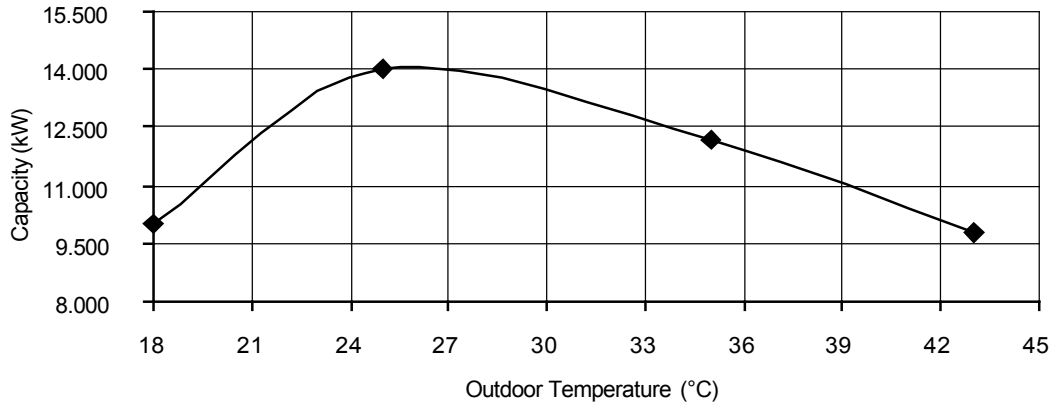

Heating Characteristics at Different Piping Length

Condition

Outdoor air temperature : 7°C (DBT), 6°C (WBT)

Indoor water inlet temperature : 30°C

Indoor water outlet temperature : 35°C

Piping length : 7 m

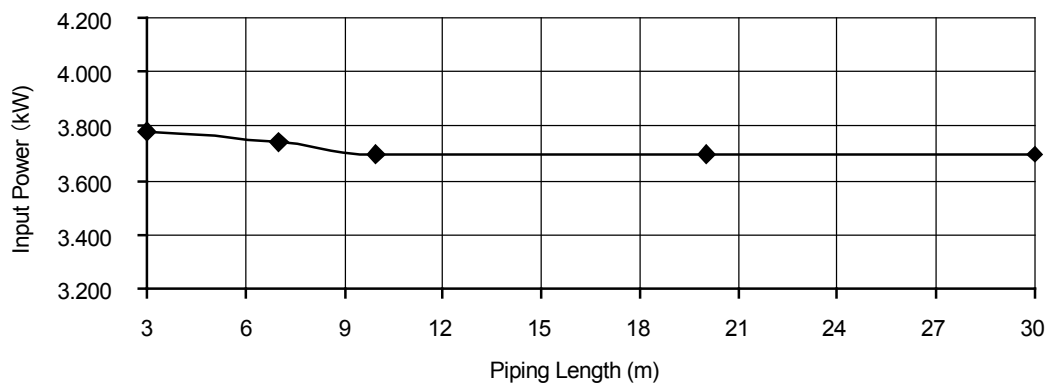
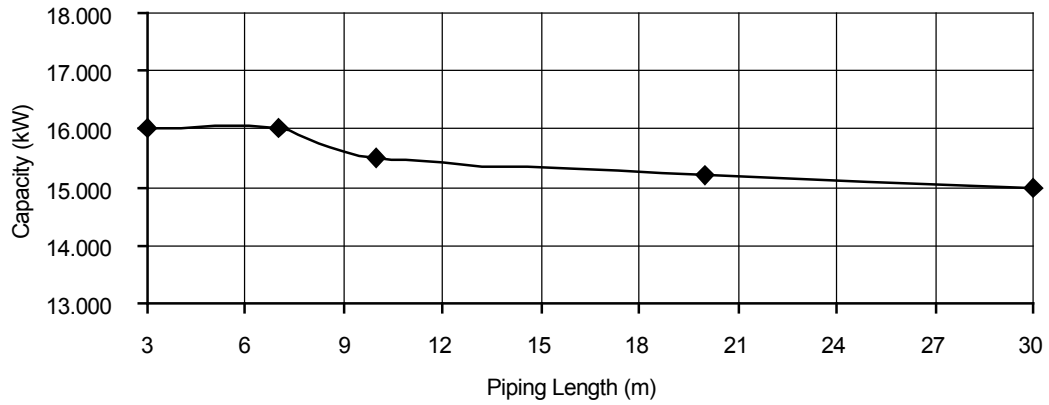

Cooling Characteristics at Different Piping Length

Condition

Outdoor air temperature : 35°C (DBT), -°C (WBT)

Indoor water inlet temperature : 12°C

Indoor water outlet temperature : 7°C

Piping length : 7 m

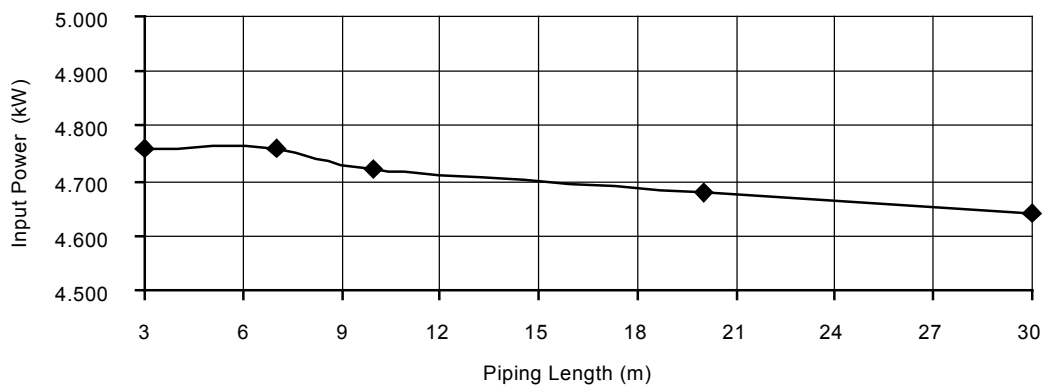
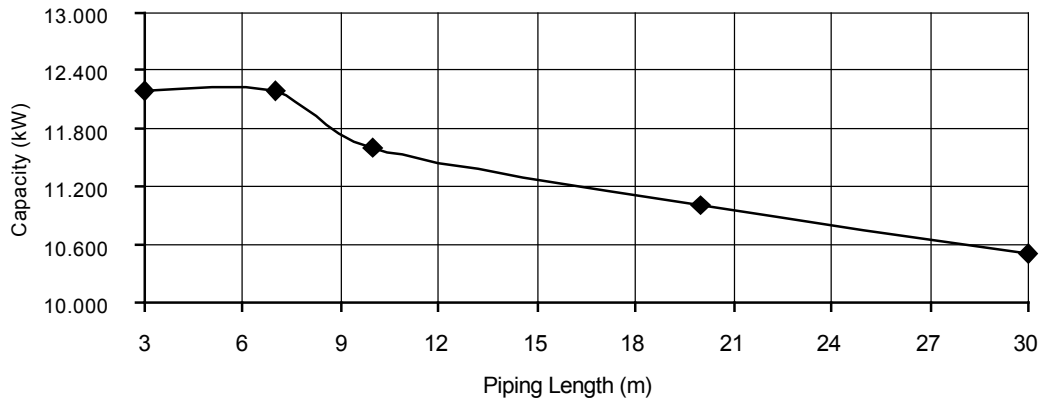

19.1.7 WH-ADC0916H9E8 WH-UD09HE8

Heating Characteristics at Different Outdoor Air Temperature

Condition

Outdoor air temperature : 7°C (DBT), 6°C (WBT)

Indoor water inlet temperature : 30°C

Indoor water outlet temperature : 35°C

Piping length : 7 m

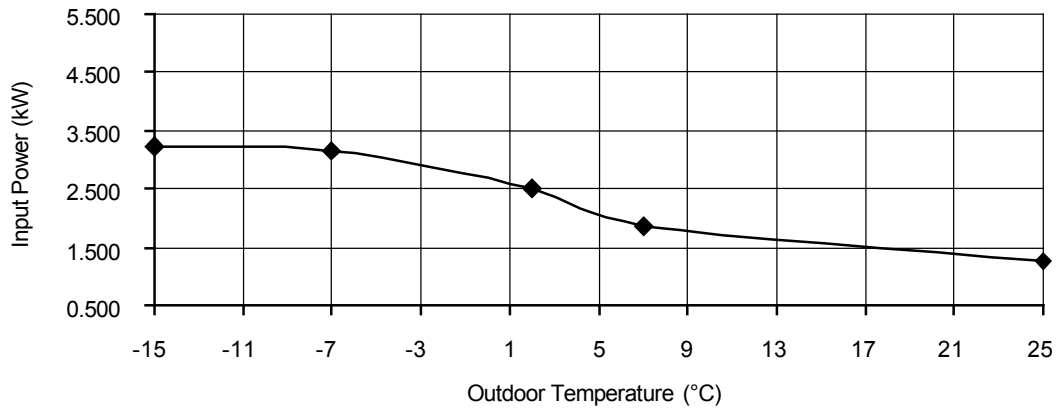
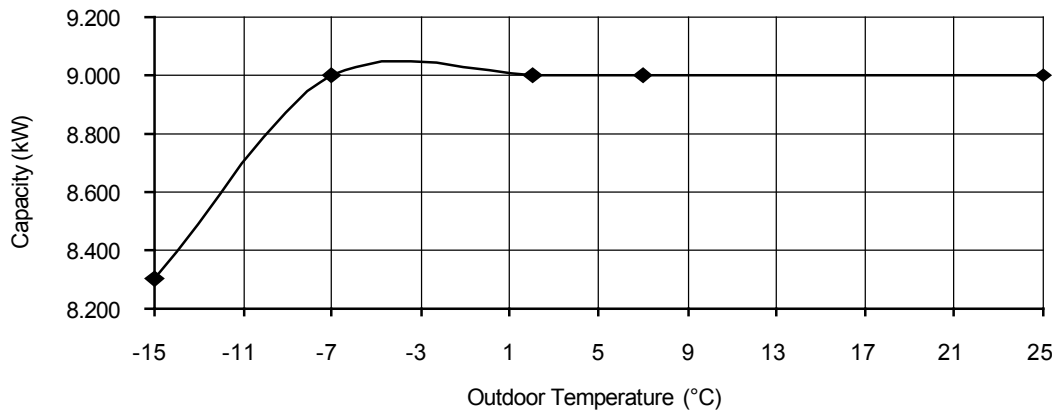

Cooling Characteristics at Different Outdoor Air Temperature

Condition

Outdoor air temperature : 35°C (DBT), -°C (WBT)

Indoor water inlet temperature : 12°C

Indoor water outlet temperature : 7°C

Piping length : 7 m

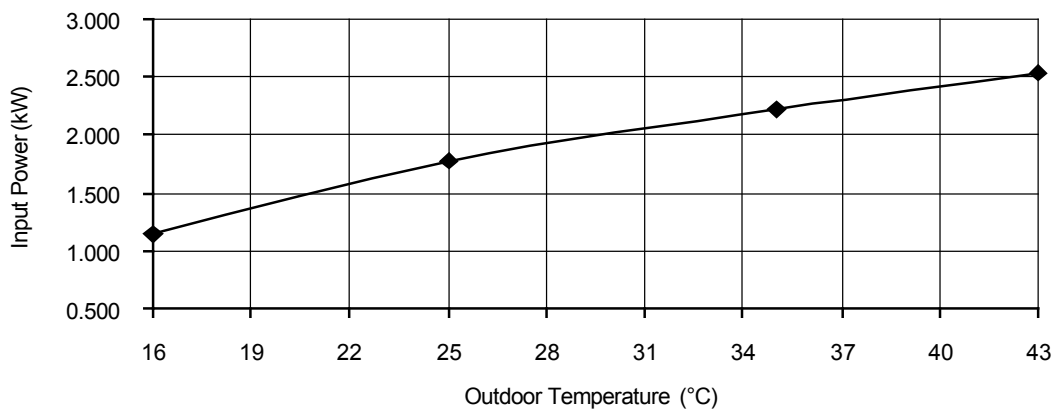
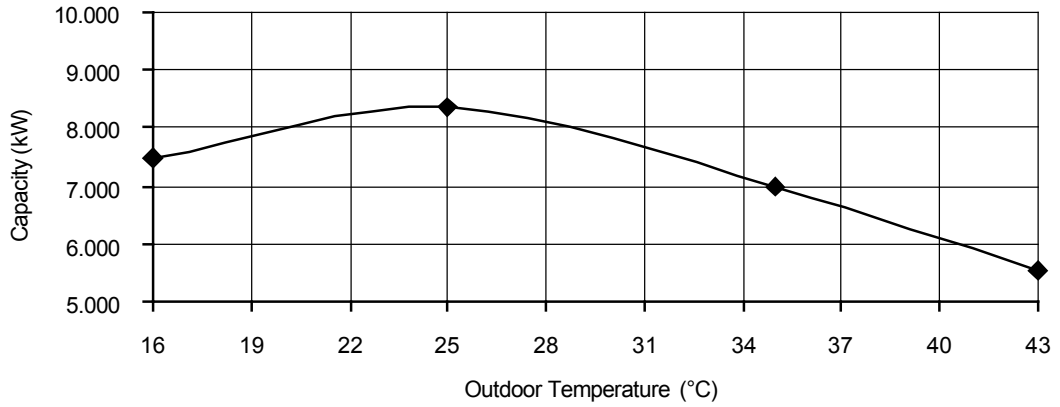

Cooling Characteristics at Different Outdoor Air Temperature

Condition

Outdoor air temperature : 35°C (DBT), -°C (WBT)

Indoor water inlet temperature : 19°C

Indoor water outlet temperature : 14°C

Piping length : 7 m

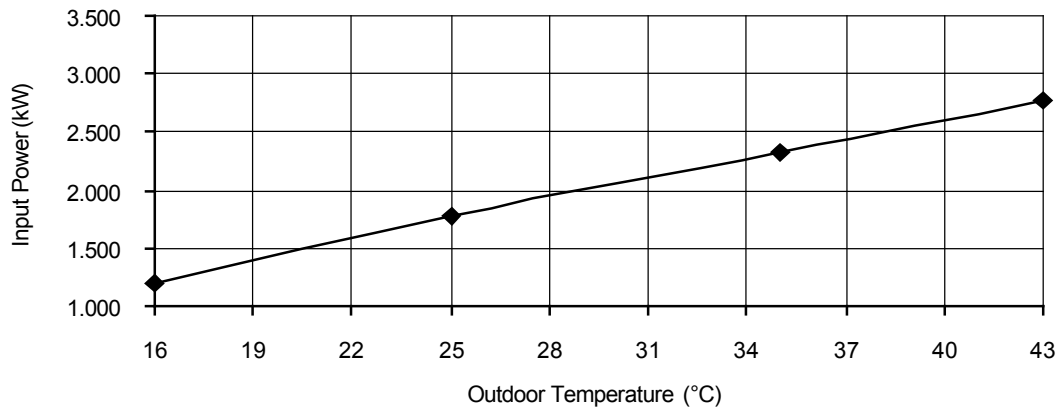
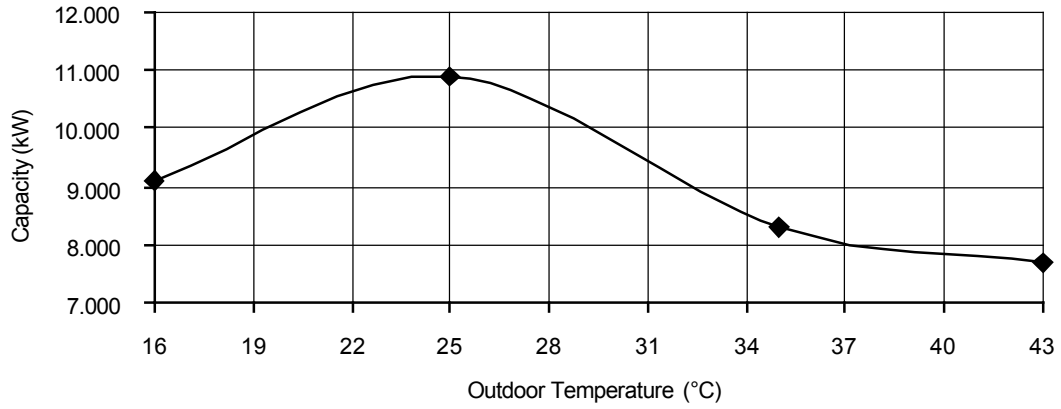

Cooling Characteristics at Different Outdoor Air Temperature

Condition

Outdoor air temperature : 35°C (DBT), -°C (WBT)

Indoor water inlet temperature : 23°C

Indoor water outlet temperature : 18°C

Piping length : 7 m

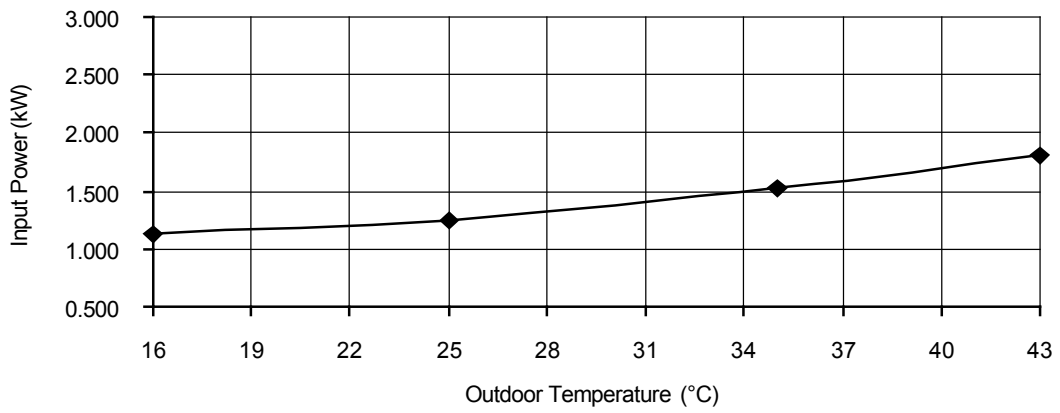
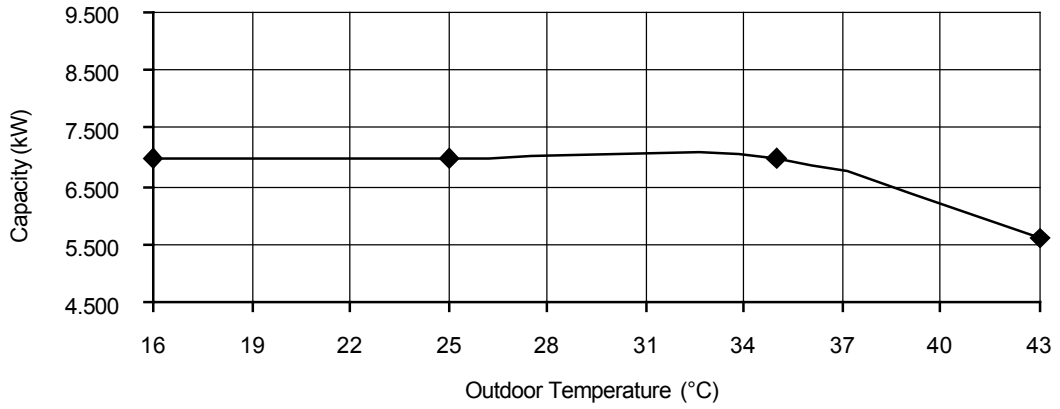

Heating Characteristics at Different Piping Length

Condition

Outdoor air temperature : 7°C (DBT), 6°C (WBT)

Indoor water inlet temperature : 30°C

Indoor water outlet temperature : 35°C

Piping length : 7 m

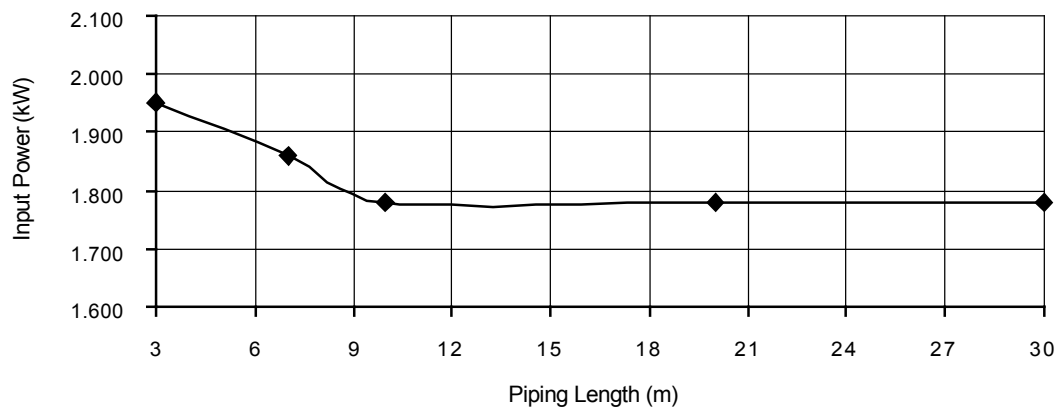
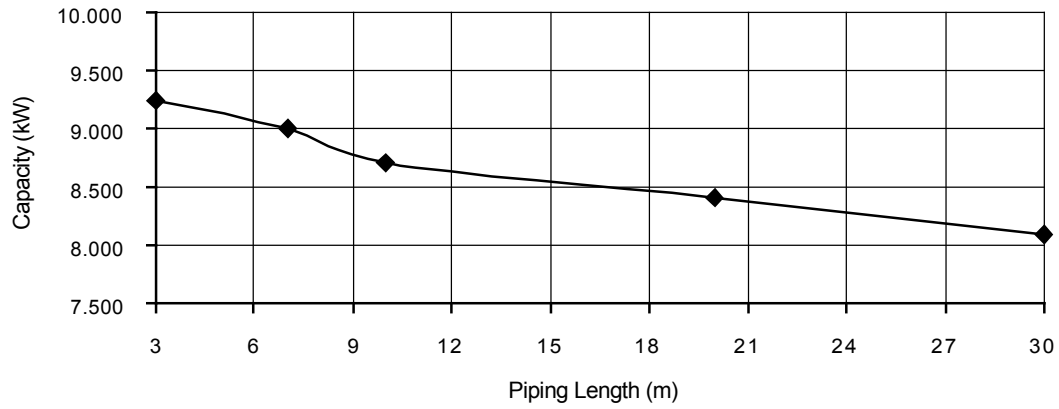

Cooling Characteristics at Different Piping Length

Condition

Outdoor air temperature : 35°C (DBT), -°C (WBT)

Indoor water inlet temperature : 12°C

Indoor water outlet temperature : 7°C

Piping length : 7 m

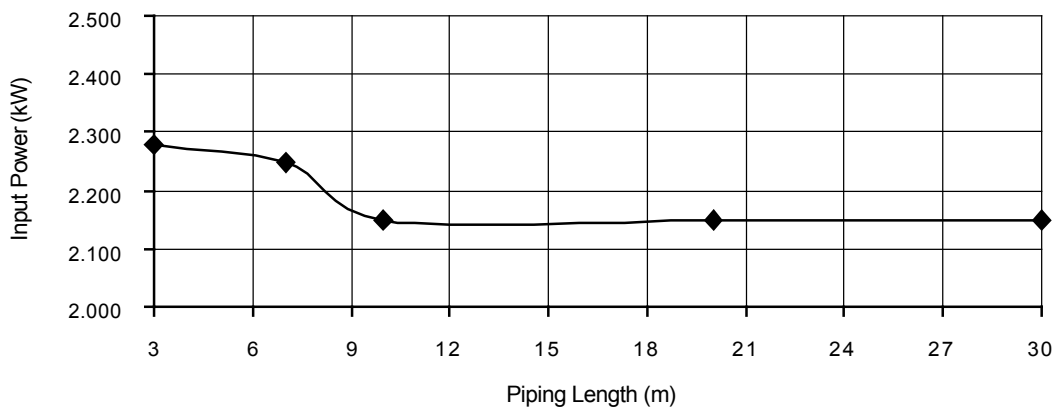
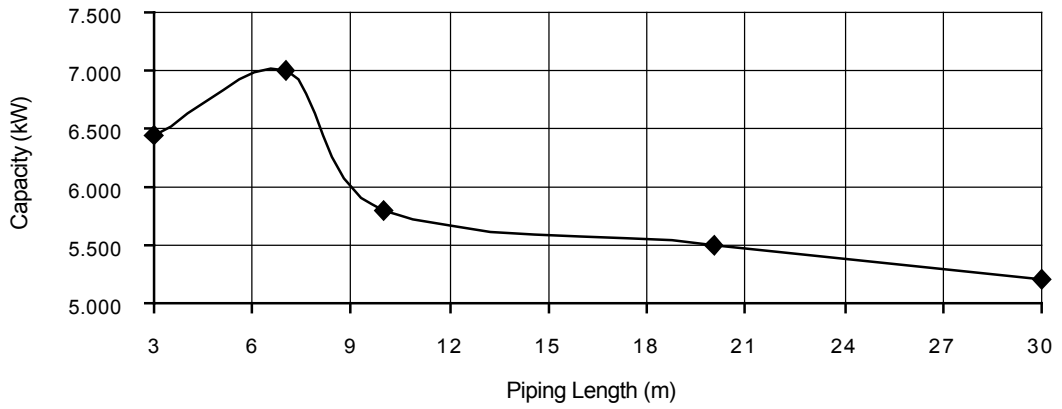

19.1.8 WH-ADC0916H9E8 WH-UD12HE8

Heating Characteristics at Different Outdoor Air Temperature

Condition

Outdoor air temperature : 7°C (DBT), 6°C (WBT)

Indoor water inlet temperature : 30°C

Indoor water outlet temperature : 35°C

Piping length : 7 m

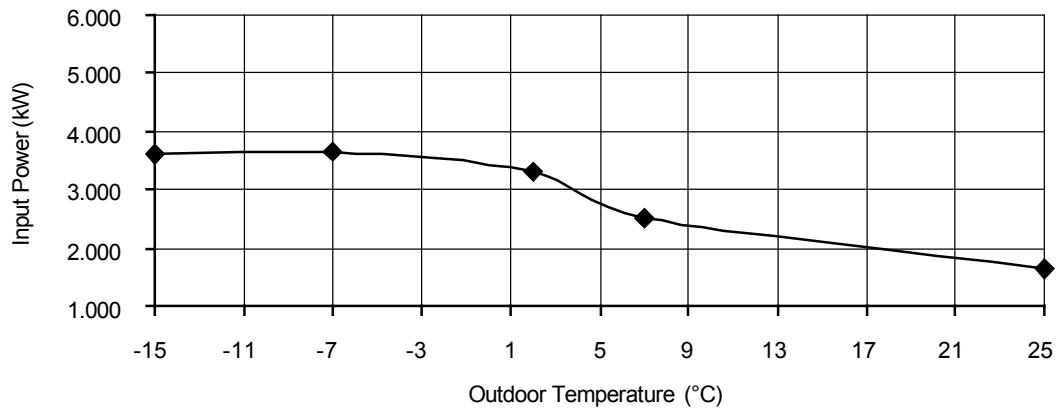
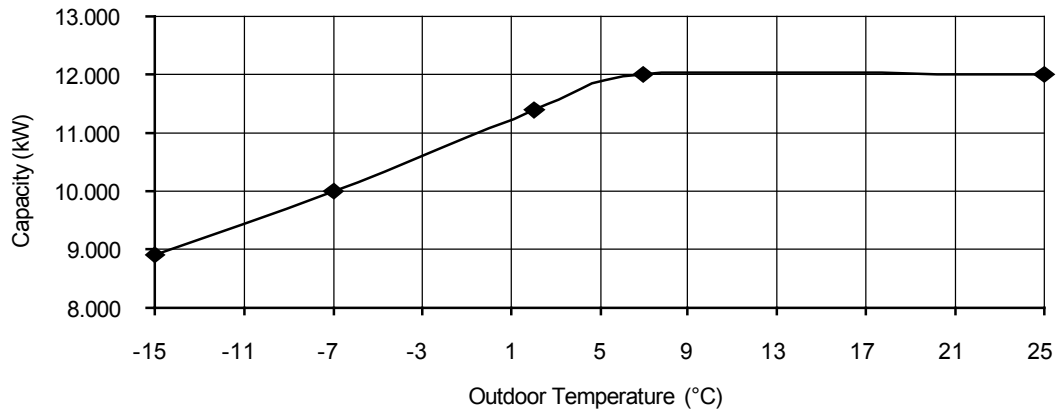

Cooling Characteristics at Different Outdoor Air Temperature

Condition

Outdoor air temperature : 35°C (DBT), -°C (WBT)

Indoor water inlet temperature : 12°C

Indoor water outlet temperature : 7°C

Piping length : 7 m

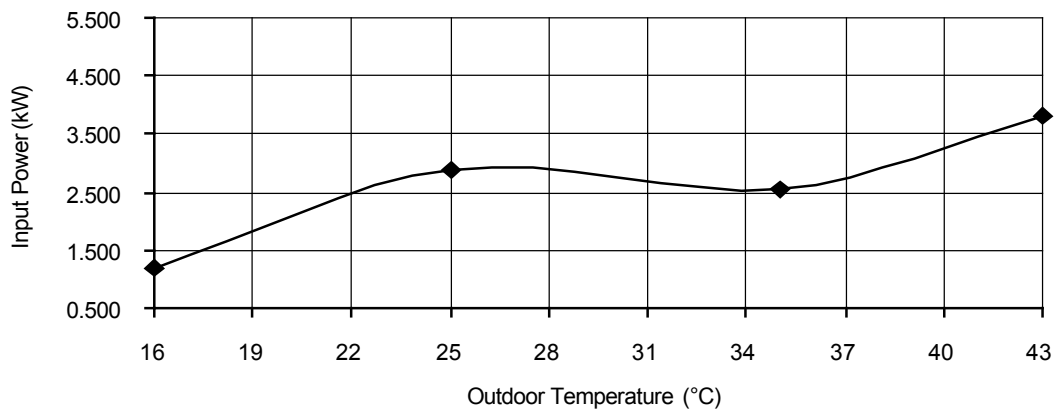
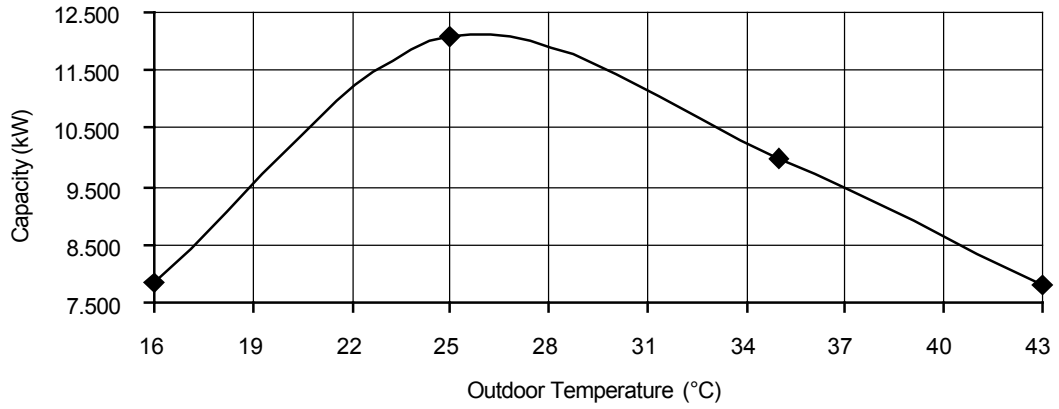

Cooling Characteristics at Different Outdoor Air Temperature

Condition

Outdoor air temperature : 35°C (DBT), -°C (WBT)

Indoor water inlet temperature : 19°C

Indoor water outlet temperature : 14°C

Piping length : 7 m

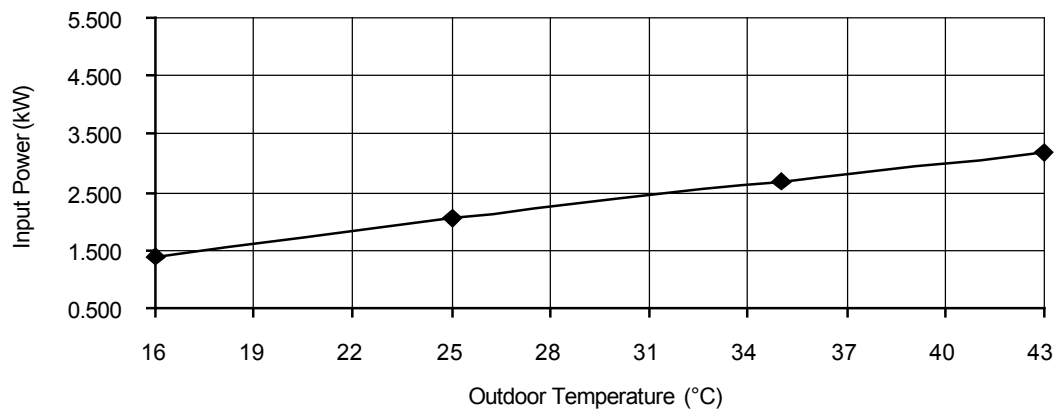
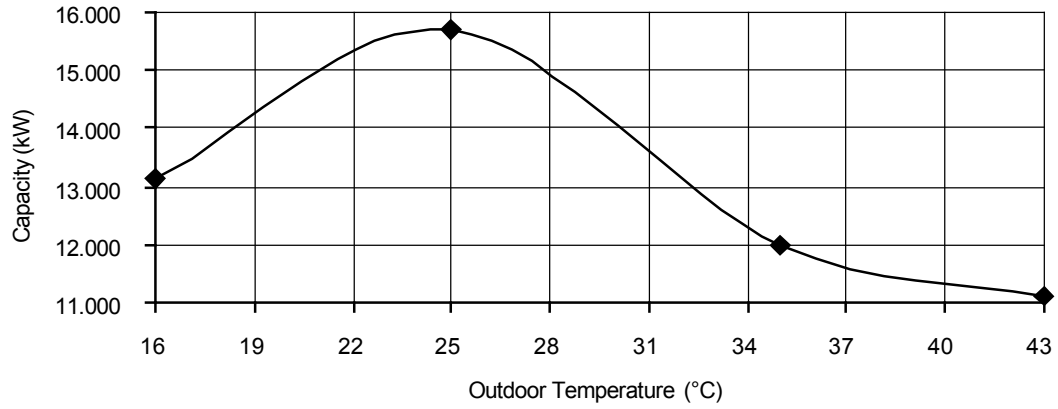

Cooling Characteristics at Different Outdoor Air Temperature

Condition

Outdoor air temperature : 35°C (DBT), -°C (WBT)

Indoor water inlet temperature : 23°C

Indoor water outlet temperature : 18°C

Piping length : 7 m

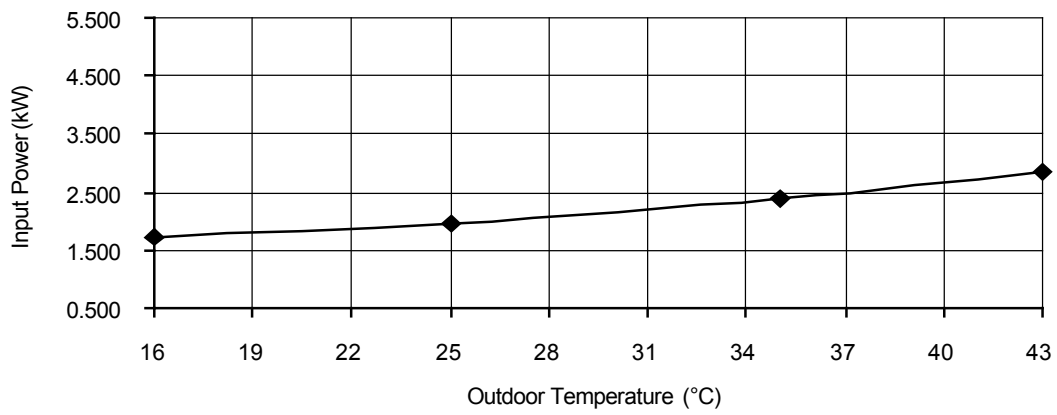
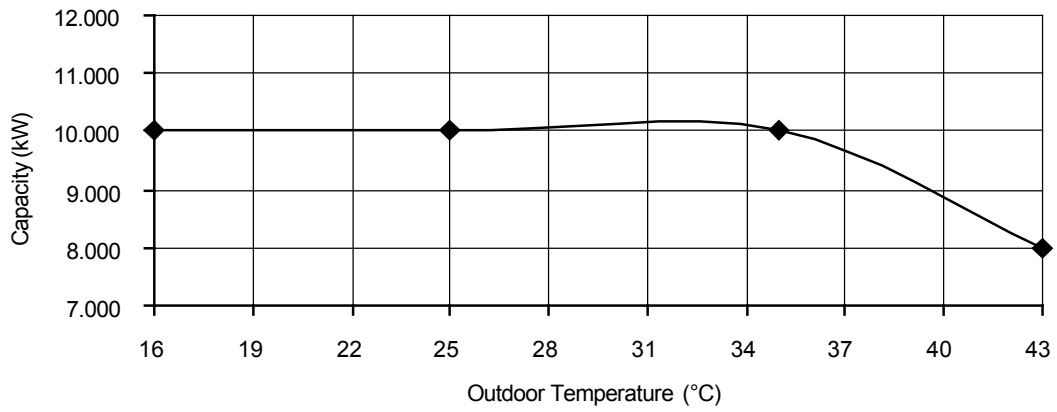

Heating Characteristics at Different Piping Length

Condition

Outdoor air temperature : 7°C (DBT), 6°C (WBT)

Indoor water inlet temperature : 30°C

Indoor water outlet temperature : 35°C

Piping length : 7 m

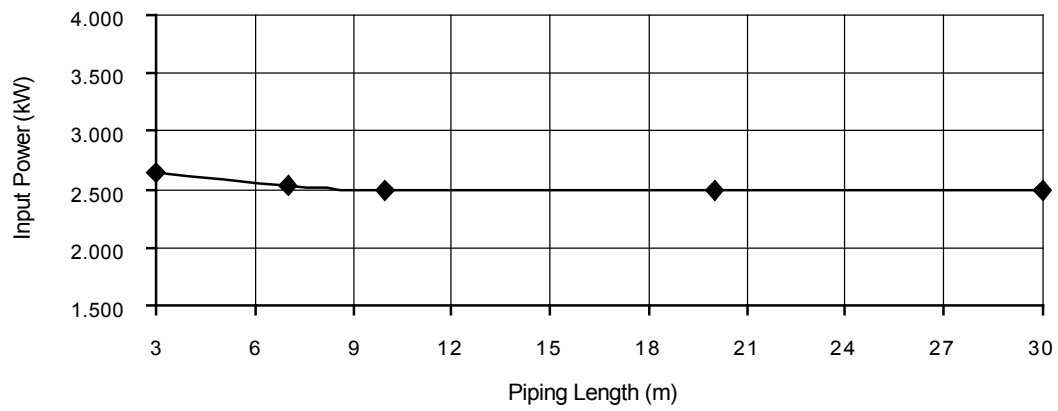
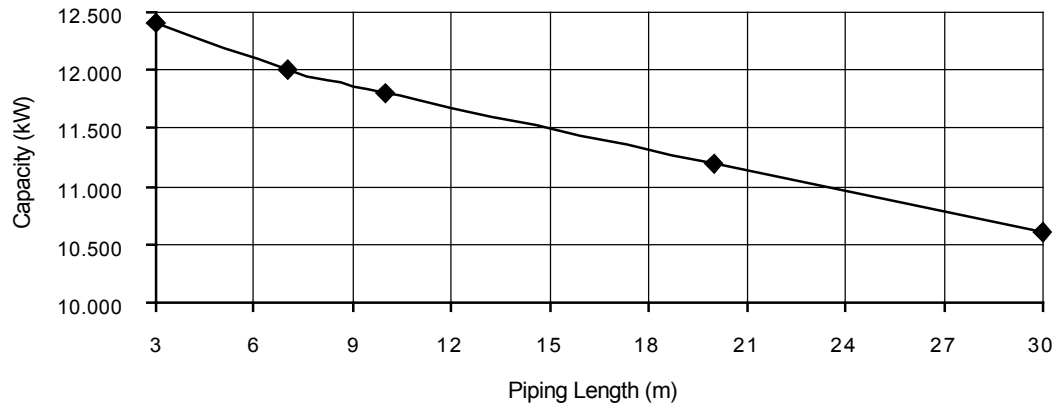

Cooling Characteristics at Different Piping Length

Condition

Outdoor air temperature : 35°C (DBT), -°C (WBT)

Indoor water inlet temperature : 12°C

Indoor water outlet temperature : 7°C

Piping length : 7 m

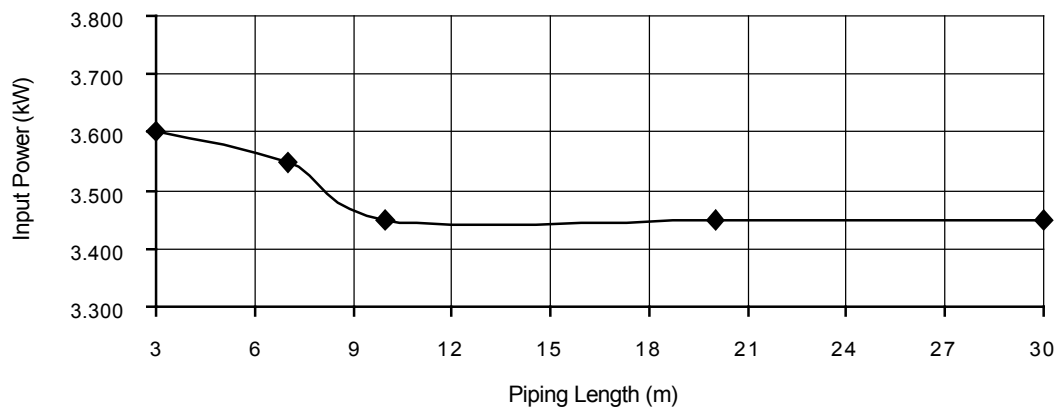
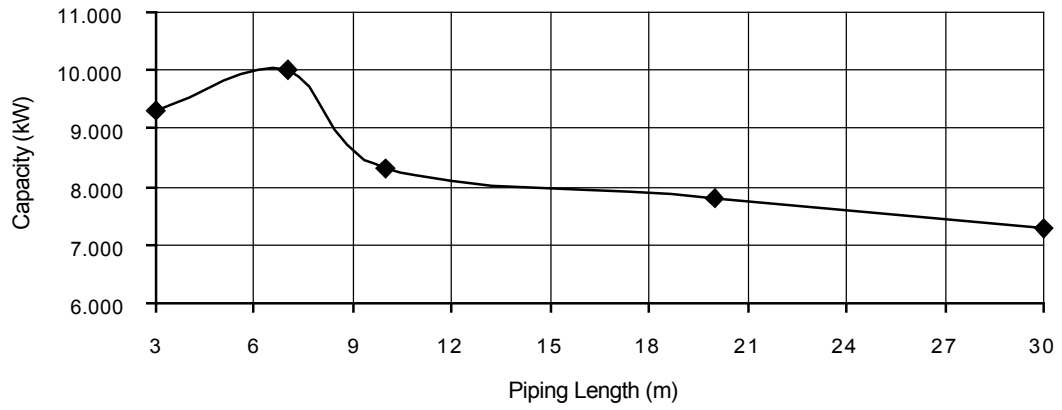

19.1.9 WH-ADC0916H9E8 WH-UD16HE8

Heating Characteristics at Different Outdoor Air Temperature

Condition

Outdoor air temperature : 7°C (DBT), 6°C (WBT)

Indoor water inlet temperature : 30°C

Indoor water outlet temperature : 35°C

Piping length : 7 m

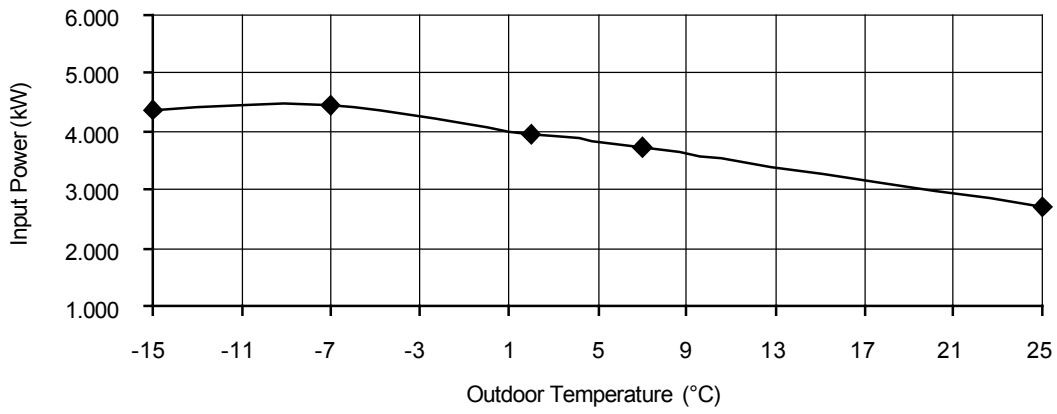
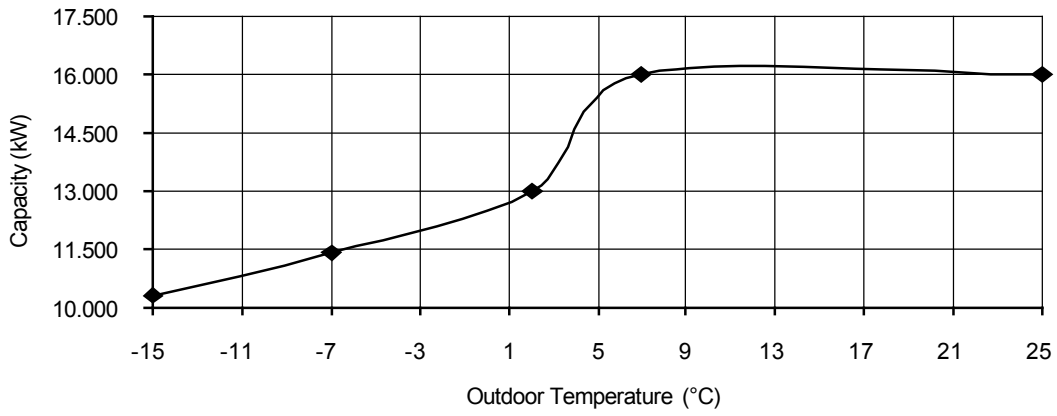

Cooling Characteristics at Different Outdoor Air Temperature

Condition

Outdoor air temperature : 35°C (DBT), -°C (WBT)

Indoor water inlet temperature : 12°C

Indoor water outlet temperature : 7°C

Piping length : 7 m

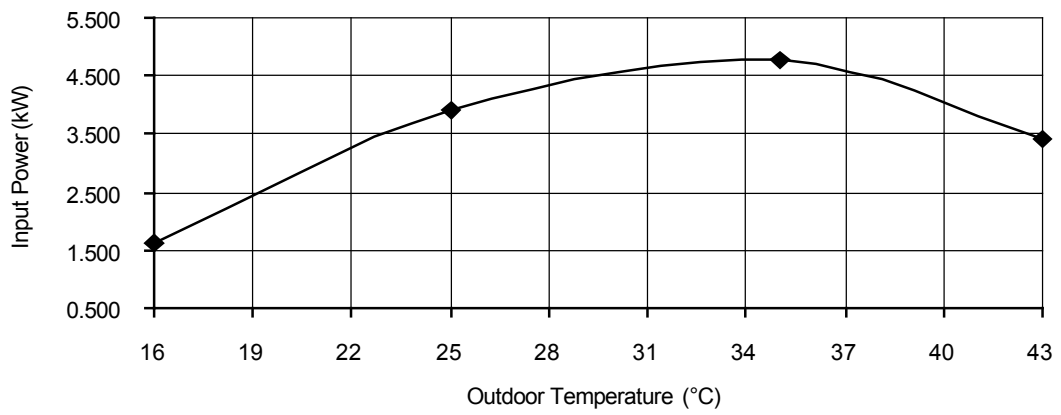
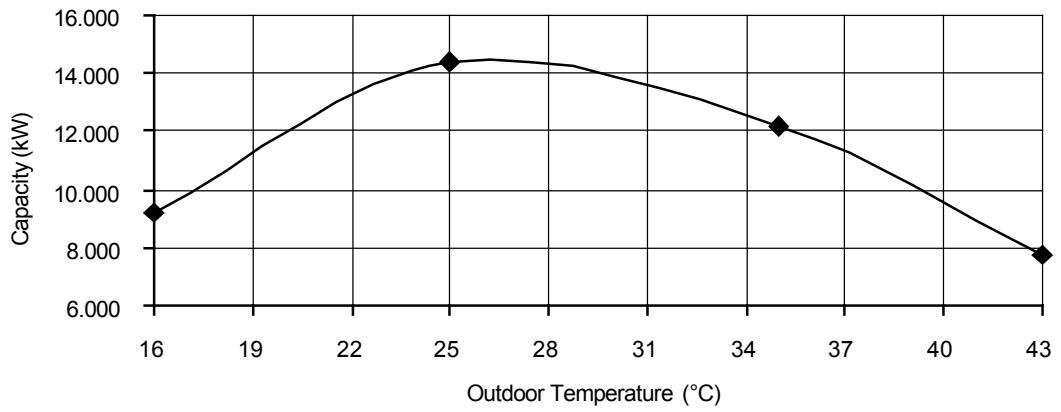

Cooling Characteristics at Different Outdoor Air Temperature

Condition

Outdoor air temperature : 35°C (DBT), -°C (WBT)

Indoor water inlet temperature : 19°C

Indoor water outlet temperature : 14°C

Piping length : 7 m

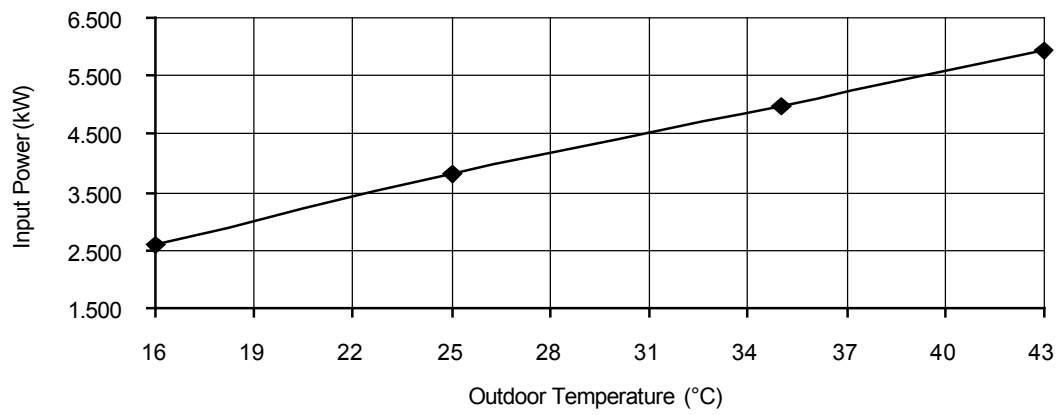
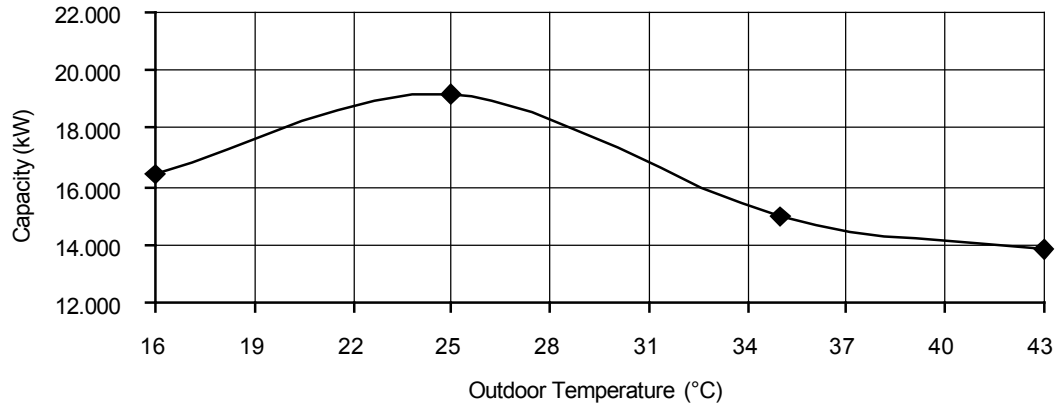

Cooling Characteristics at Different Outdoor Air Temperature

Condition

Outdoor air temperature : 35°C (DBT), -°C (WBT)

Indoor water inlet temperature : 23°C

Indoor water outlet temperature : 18°C

Piping length : 7 m

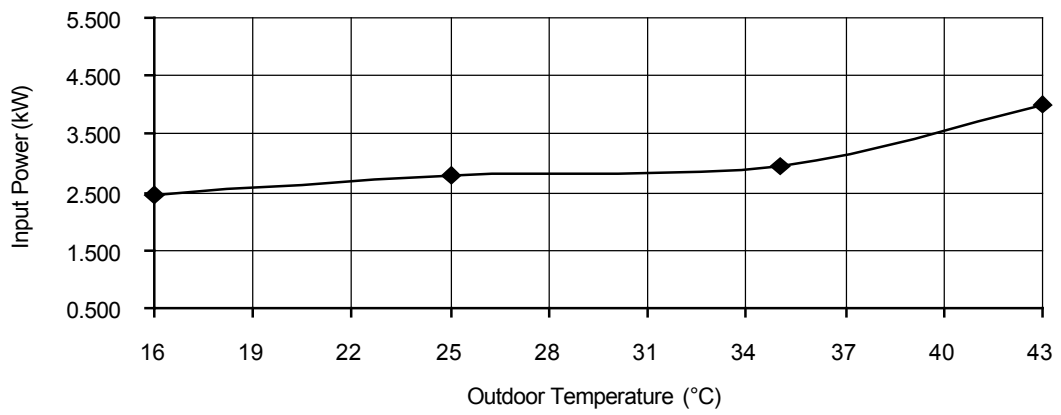
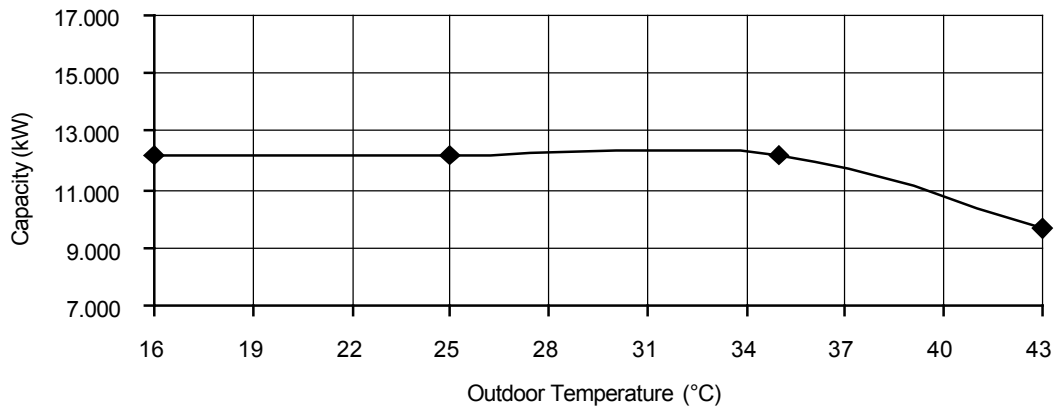

Heating Characteristics at Different Piping Length

Condition

Outdoor air temperature : 7°C (DBT), 6°C (WBT)

Indoor water inlet temperature : 30°C

Indoor water outlet temperature : 35°C

Piping length : 7 m

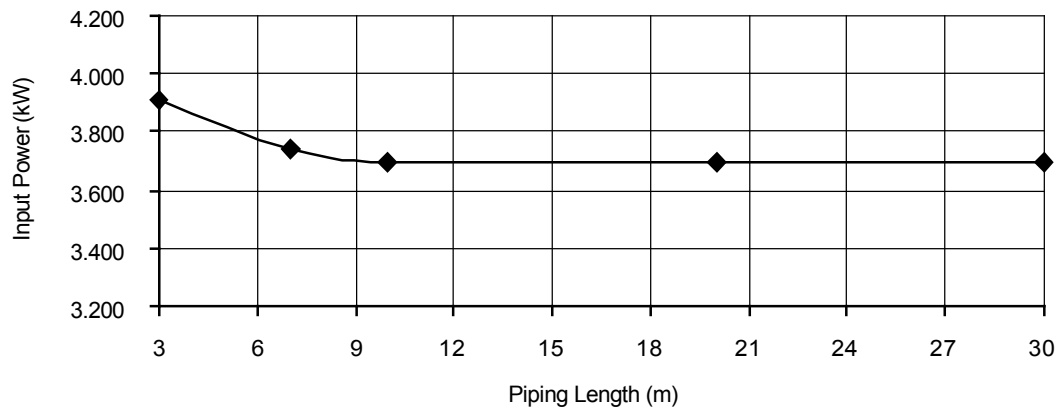
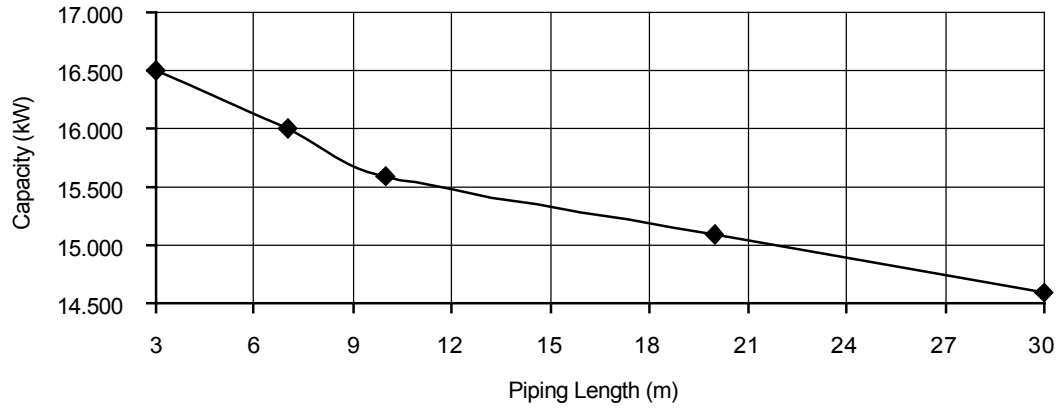

Cooling Characteristics at Different Piping Length

Condition

Outdoor air temperature : 35°C (DBT), -°C (WBT)

Indoor water inlet temperature : 12°C

Indoor water outlet temperature : 7°C

Piping length : 7 m

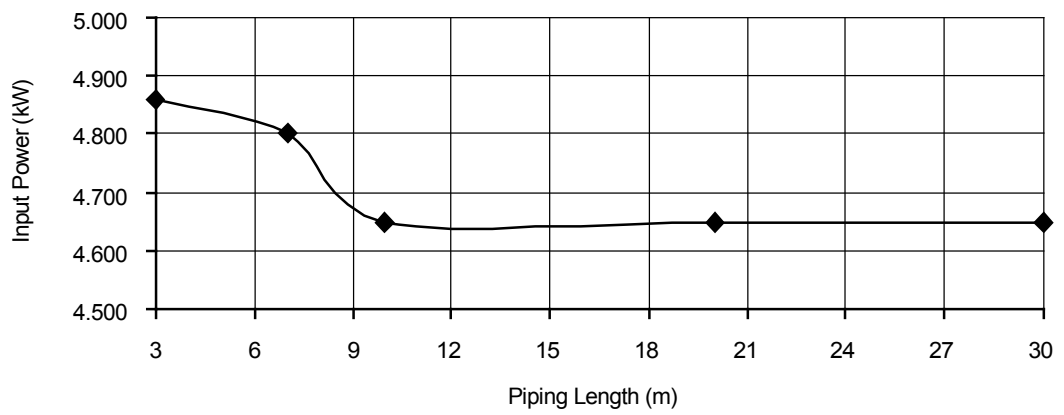
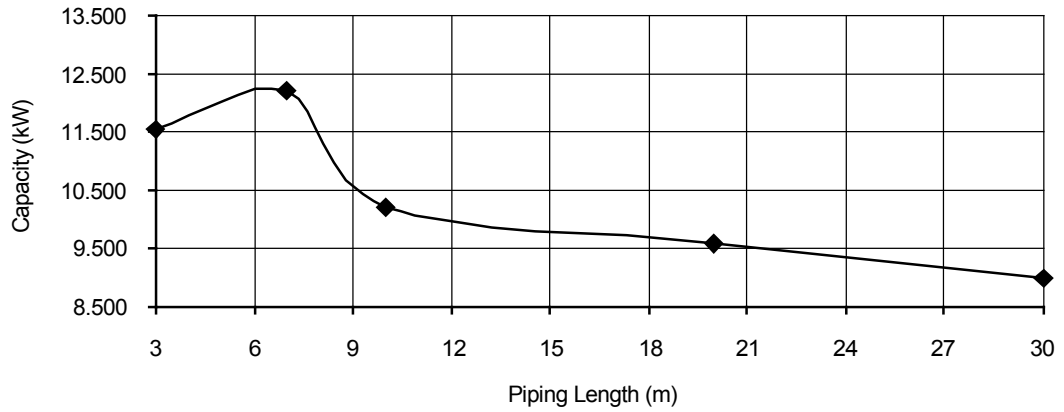

19.2 Heating Capacity Table

19.2.1 WH-UQ09HE8

Water Out (°C)	30		35		40		45		50		55	
Outdoor Air (°C)	Capacity (W)	Input Power (W)	Capacity (W)	Input Power (W)	Capacity (W)	Input Power (W)	Capacity (W)	Input Power (W)	Capacity (W)	Input Power (W)	Capacity (W)	Input Power (W)
-15	9000	3240	9000	3510	9000	3910	9000	4300	9000	4730	9000	5160
-7	9000	2710	9000	3160	9000	3620	9000	4070	9000	4270	9000	4460
2	9000	2360	9000	2510	9000	2780	9000	3050	9000	3560	9000	4070
7	9000	1640	9000	1860	9000	2160	9000	2460	9000	2760	9000	3060
25	13600	1500	13600	1710	13200	1930	12800	2140	12000	2410	11200	2670

19.2.2 WH-UQ12HE8

Water Out (°C)	30		35		40		45		50		55	
Outdoor Air (°C)	Capacity (W)	Input Power (W)	Capacity (W)	Input Power (W)	Capacity (W)	Input Power (W)	Capacity (W)	Input Power (W)	Capacity (W)	Input Power (W)	Capacity (W)	Input Power (W)
-15	12000	4750	12000	4960	12000	5410	12000	5860	11800	6240	11600	6620
-7	12000	3850	12000	4410	12000	4980	12000	5540	12000	5900	12000	6260
2	12000	3190	12000	3490	12000	3870	12000	4250	12000	4860	12000	5470
7	12000	2180	12000	2530	12000	2960	12000	3390	12000	3780	12000	4160
25	13600	1550	13600	1760	13400	2100	13200	2430	12600	2660	12000	2890

19.2.3 WH-UQ16HE8

Water Out (°C)	30		35		40		45		50		55	
Outdoor Air (°C)	Capacity (W)	Input Power (W)	Capacity (W)	Input Power (W)	Capacity (W)	Input Power (W)	Capacity (W)	Input Power (W)	Capacity (W)	Input Power (W)	Capacity (W)	Input Power (W)
-15	16000	6300	16000	6890	16000	7450	16000	8100	16000	8480	15200	8960
-7	16000	5850	16000	6420	16000	7000	16000	7570	16000	8100	16000	8620
2	16000	4670	16000	5210	16000	5740	16000	6310	16000	6900	16000	7500
7	16000	3350	16000	3740	16000	4300	16000	4800	16000	5430	16000	5910
16	16000	2590	16000	3180	16000	3710	16000	4270	16000	4860	16000	5220
25	16000	2020	16000	2580	16000	2910	16000	3360	16000	3740	16000	4000

19.2.4 WH-UX09HE8

Water Out (°C)	30		35		40		45		50		55	
Outdoor Air (°C)	Capacity (W)	Input Power (W)	Capacity (W)	Input Power (W)	Capacity (W)	Input Power (W)	Capacity (W)	Input Power (W)	Capacity (W)	Input Power (W)	Capacity (W)	Input Power (W)
-15	9000	3240	9000	3510	9000	3910	9000	4300	9000	4730	9000	5160
-7	9000	2710	9000	3160	9000	3620	9000	4070	9000	4270	9000	4460
2	9000	2360	9000	2510	9000	2780	9000	3050	9000	3560	9000	4070
7	9000	1640	9000	1860	9000	2160	9000	2460	9000	2760	9000	3060
25	13600	1500	13600	1710	13200	1930	12800	2140	12000	2410	11200	2670

19.2.5 WH-UX12HE8

Water Out (°C)	30		35		40		45		50		55	
Outdoor Air (°C)	Capacity (W)	Input Power (W)	Capacity (W)	Input Power (W)	Capacity (W)	Input Power (W)	Capacity (W)	Input Power (W)	Capacity (W)	Input Power (W)	Capacity (W)	Input Power (W)
-15	12000	4750	12000	4960	12000	5410	12000	5860	11800	6240	11600	6620
-7	12000	3850	12000	4410	12000	4980	12000	5540	12000	5900	12000	6260
2	12000	3190	12000	3490	12000	3870	12000	4250	12000	4860	12000	5470
7	12000	2180	12000	2530	12000	2960	12000	3390	12000	3780	12000	4160
25	13600	1550	13600	1760	13400	2100	13200	2430	12600	2660	12000	2890

19.2.6 WH-UX16HE8

Water Out (°C)	30		35		40		45		50		55	
Outdoor Air (°C)	Capacity (W)	Input Power (W)	Capacity (W)	Input Power (W)	Capacity (W)	Input Power (W)	Capacity (W)	Input Power (W)	Capacity (W)	Input Power (W)	Capacity (W)	Input Power (W)
-15	16000	6300	16000	6890	16000	7450	16000	8100	16000	8480	15200	8960
-7	16000	5850	16000	6420	16000	7000	16000	7570	16000	8100	16000	8620
2	16000	4670	16000	5210	16000	5740	16000	6310	16000	6900	16000	7500
7	16000	3350	16000	3740	16000	4300	16000	4800	16000	5430	16000	5910
16	16000	2590	16000	3180	16000	3710	16000	4270	16000	4860	16000	5220
25	16000	2020	16000	2580	16000	2910	16000	3360	16000	3740	16000	4000

19.2.7 WH-UD09HE8

Water Out (°C)	30		35		40		45		50		55	
Outdoor Air (°C)	Capacity (W)	Input Power (W)	Capacity (W)	Input Power (W)	Capacity (W)	Input Power (W)	Capacity (W)	Input Power (W)	Capacity (W)	Input Power (W)	Capacity (W)	Input Power (W)
-15	8650	3060	8300	3210	7950	3410	7600	3610	7150	3710	6700	3810
-7	9350	2910	9000	3160	8850	3540	8700	3920	8300	3890	7900	3860
2	9310	2350	9000	2510	9000	2780	9000	3050	8900	3490	8800	3940
7	9000	1540	9000	1860	9000	2160	9000	2460	9000	2760	9000	3060
25	9000	1050	9000	1240	8730	1440	8460	1640	8280	1820	8100	2000

19.2.8 WH-UD12HE8

Water Out (°C)	30		35		40		45		50		55	
Outdoor Air (°C)	Capacity (W)	Input Power (W)	Capacity (W)	Input Power (W)	Capacity (W)	Input Power (W)	Capacity (W)	Input Power (W)	Capacity (W)	Input Power (W)	Capacity (W)	Input Power (W)
-15	9300	3460	8900	3620	8500	3790	8100	3950	7500	4050	7000	4160
-7	10400	3370	10000	3660	9600	3950	9200	4240	8700	4260	8200	4270
2	11800	3100	11400	3310	11000	3530	10600	3740	9800	3940	9100	4140
7	12000	2100	12000	2530	12000	2960	12000	3390	12000	3780	12000	4160
25	12000	1380	12000	1660	11800	1940	11700	2230	11500	2490	11400	2740

19.2.9 WH-UD16HE8

Water Out (°C)	30		35		40		45		50		55	
Outdoor Air (°C)	Capacity (W)	Input Power (W)	Capacity (W)	Input Power (W)	Capacity (W)	Input Power (W)	Capacity (W)	Input Power (W)	Capacity (W)	Input Power (W)	Capacity (W)	Input Power (W)
-15	10600	4090	10300	4380	10000	4670	9700	4960	8800	4940	7900	4910
-7	11900	4030	11400	4430	10800	4830	10300	5220	9600	5090	9000	4950
2	13500	3740	13000	3960	12400	4180	11900	4400	10800	4460	9800	4510
7	16000	3210	16000	3740	16000	4270	16000	4800	15200	5110	14500	5410
25	16000	2310	16000	2960	16000	3070	16000	3450	16000	3670	15900	3890

19.3 Cooling Capacity Table

19.3.1 WH-ADC0916H9E8 WH-UQ09HE8 WH-ADC0916H9E8 WH-UQ12HE8

Outdoor Air (°C)	WH-UQ09HE8		WH-UQ12HE8	
	Capacity (W)	Input Power (W)	Capacity (W)	Input Power (W)
18	7000	1360	7500	1410
25	7650	1910	8900	2160
35	7000	2210	10000	3560
43	6250	2660	8000	3010

19.3.2 WH-ADC0916H9E8 WH-UQ16HE8

Outdoor Air (°C)	7		18	
	Capacity (W)	Input Power (W)	Capacity (W)	Input Power (W)
18	8500	1700	10000	1700
25	14000	4000	14000	2940
35	12200	4760	12200	3500
43	7100	3310	9800	3310

19.3.3 WH-ADC0916H9E8 WH-UX09HE8

Outdoor Air (°C)	Capacity (W)	Input Power (W)
18	7000	1360
25	7650	1910
35	7000	2210
43	6250	2660

19.3.4 WH-ADC0916H9E8 WH-UX12HE8

Outdoor Air (°C)	Capacity (W)	Input Power (W)
18	7500	1410
25	8900	2160
35	10000	3560
43	8000	3010

19.3.5 WH-ADC0916H9E8 WH-UX16HE8

Outdoor Air (°C)	7		18	
	Capacity (W)	Input Power (W)	Capacity (W)	Input Power (W)
18	8500	1700	10000	1700
25	14000	4000	14000	2940
35	12200	4760	12200	3500
43	7100	3310	9800	3310

19.3.6 WH-ADC0916H9E8 WH-UD09HE8

Water In (°C)	12		19		23	
Water Out (°C)	7		14		18	
Outdoor Air (°C)	Capacity (W)	Input Power (W)	Capacity (W)	Input Power (W)	Capacity (W)	Input Power (W)
16	7500	1150	9100	1200	7000	1130
25	8350	1770	10900	1780	7000	1240
35	7000	2230	8300	2320	7000	1520
43	5520	2540	7690	2770	5600	1800

19.3.7 WH-ADC0916H9E8 WH-UD12HE8

Water In (°C)	12		19		23	
Water Out (°C)	7		14		18	
Outdoor Air (°C)	Capacity (W)	Input Power (W)	Capacity (W)	Input Power (W)	Capacity (W)	Input Power (W)
16	7860	1180	13150	1400	10000	1730
25	12080	2900	15700	2050	10000	1970
35	10000	2560	12000	2670	10000	2400
43	7800	3800	11100	3190	8000	2850

19.3.8 WH-ADC0916H9E8 WH-UD16HE8

Water In (°C)	12		19		23	
Water Out (°C)	7		14		18	
Outdoor Air (°C)	Capacity (W)	Input Power (W)	Capacity (W)	Input Power (W)	Capacity (W)	Input Power (W)
16	9200	1620	16400	2580	12200	2450
25	14400	3920	19200	3830	12200	2790
35	12200	4760	15000	4980	12200	2960
43	7750	3400	13800	5950	9700	4000

20. Exploded View and Replacement Parts List

20.1 Indoor Unit

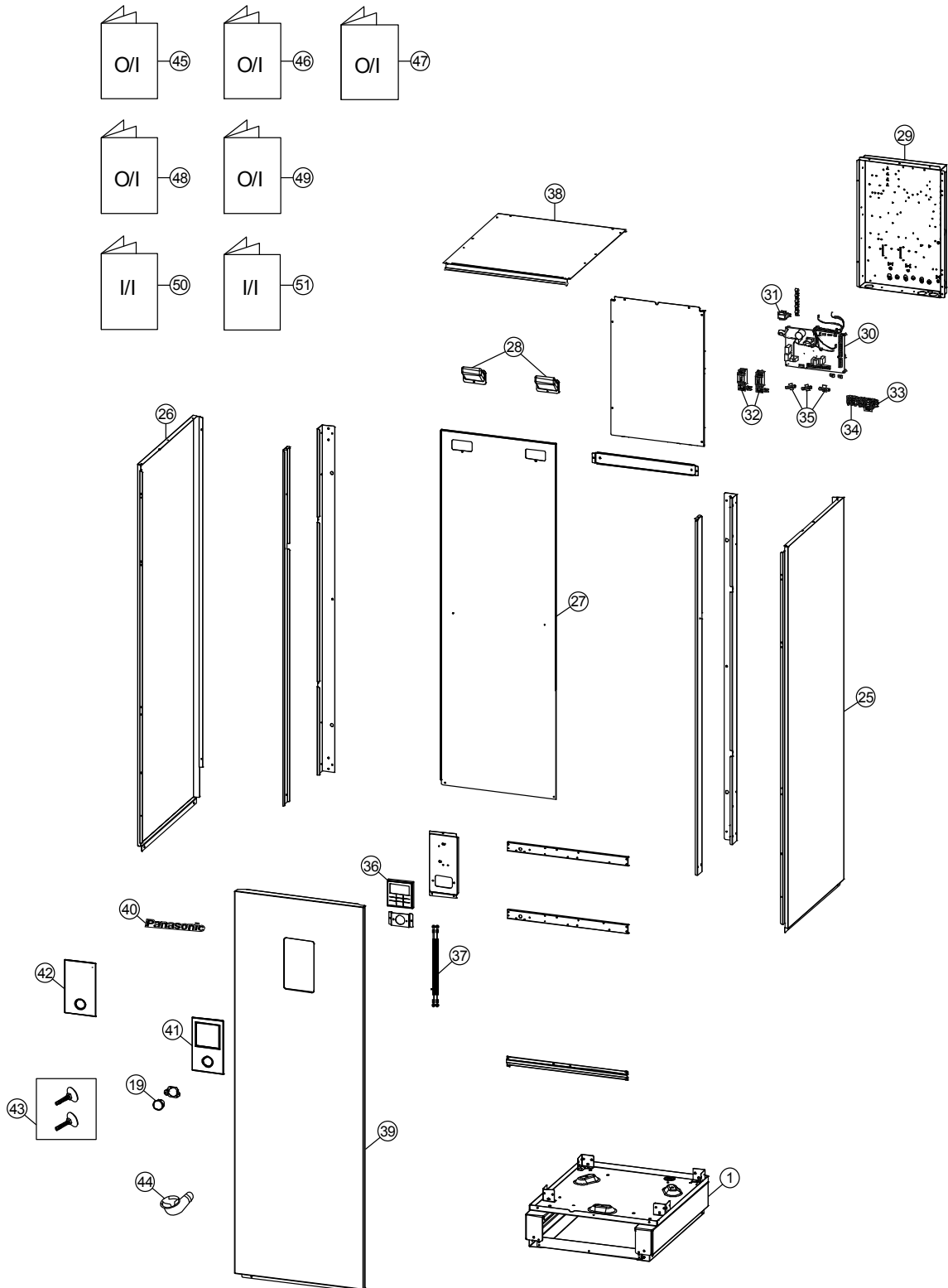

Note:

- The above exploded view is for the purpose of parts disassembly and replacement.
- The non-numbered parts are not kept as standard service parts.

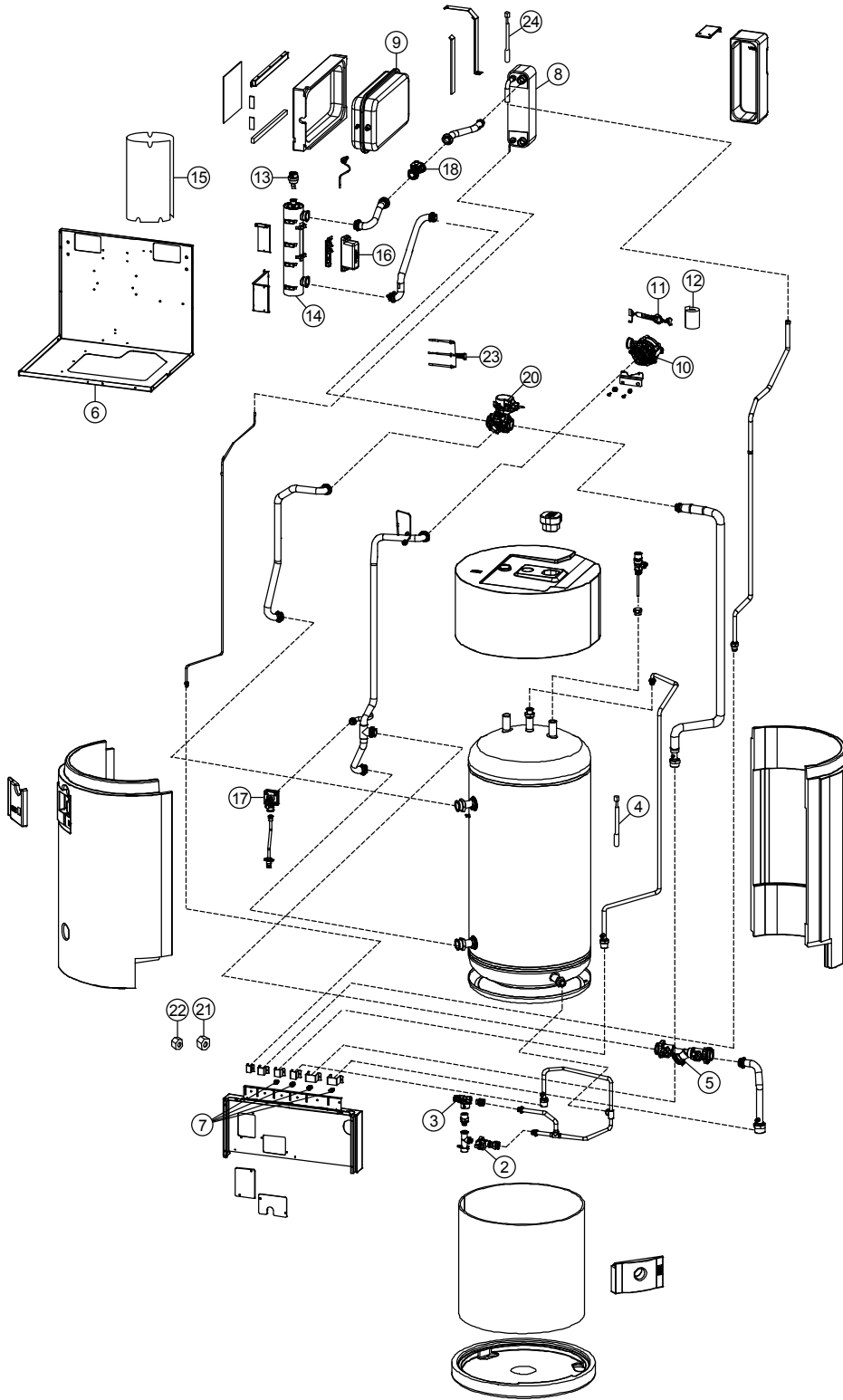

Note:

- The above exploded view is for the purpose of parts disassembly and replacement.
- The non-numbered parts are not kept as standard service parts.

SAFETY	REF. NO.	DESCRIPTION	QTY.	WH-ADC0916H9E8	REMARK
	1	CHASSIS-COMPLETE	1	ACXD50C00250	
	2	DRAIN VALVE	1	CWB65C1026	O
	3	PRESSURE AND TEMP RELIEF VALVE (TANK)	1	ACXB62-00110	O
	4	SENSOR CO. (TANK TEMP CN-TH2)	1	CWA50C3257	O
	5	FILTER COMPLETE	1	CWB51C1021	
	6	BASE PAN (HEATER)	1	ACXD52-00260	
	7	PURGE PLUG	4	CWB821027	O
	8	HOT WATER COIL-COMPLETE	1	ACXB90C00420	
	9	RECEIVER	1	CWB141073	
△	10	WATER PUMP	1	CWB532116	O
	11	LEAD WIRE FOR WATER PUMP	1	ACXA60C06140	
	12	FERRITE CORE	1	CWA431122	O
	13	AIR PURGE VALVE	1	ACXB62-00130	O
	14	HEATER ASS'Y	1	ACXA34K00090	
	15	SOUND PROOF MATERIAL	1	ACXG30-00680	
	16	THERMOSTAT	4	CWA151074	O
	17	PRESSURE RELIEF VALVE	1	CWB621136	O
	18	FLOW SWITCH	1	CWB621137	O
	19	PRESSURE GAUGE	1	CWB070003	
	20	3 WAY VALVE (WATER)	1	ACXB62-00090	
	21	FLARE NUT (5/8)	1	CWT251064	
	22	FLARE NUT (1/4)	1	CWT251063	
	23	SENSOR-CO. (WATER IN OUT, REF TEMP SENSOR CN-TH1)	1	ACXA50C00650	O
	24	SENSOR-CO. (HEX WATER OUTLET TEMP CN-TH3)	1	ACXA50C00660	O
	25	CABINET SIDE PLATE (R)	1	ACXE04-00400A	
	26	CABINET SIDE PLATE (L)	1	ACXE04-00390A	
	27	CABINET REAR PLATE	1	ACXE02-00070	
	28	HANDLE	2	CWE161014	
	29	CONTROL BOARD	1	ACXH10-00710	
△	30	ELECTRONIC CONTROLLER-MAIN	1	ACXA73C11340	O
△	31	REACTOR	1	G0C103Z00003	O
△	32	RESIDUAL CURRENT-CIRCUIT BREAKER	2	CWA181008	O
△	33	TERMINAL BOARD ASSY (1, 2, 3)	1	CWA28K1240	O
△	34	TERMINAL BOARD ASSY (A, B)	1	CWA28K1238	O
	35	HOLDER-P.S. CORD	3	CWH31103	
	36	REMOTE CONTROL COMPLETE	1	CWA75C4681	O
	37	LEAD WIRE FOR REMOTE CONTROL	1	ACXA60C04350	
	38	CABINET TOP PLATE	1	ACXE03K00040	
	39	CABINET FRONT PLATE	1	ACXE06-00030A	
	40	PANASONIC BADGE	1	CWE375343	
	41	DECORATION BASE ASS'Y	1	CWE35K1285	
	42	ACCESSORY-CO. (DECORATION BASE ASS'Y)	1	CWH82C2174	
	43	ACCESSORY ADJUSTABLE FEET	1	CWH82C2112	
	44	ACCESSORY CO. (DRAIN ELBOW)	1	CWG87C900	
	45	OPERATING INSTRUCTION	1	ACXF55-04210	
	46	OPERATING INSTRUCTION	1	ACXF55-04220	
	47	OPERATING INSTRUCTION	1	ACXF55-04230	
	48	OPERATING INSTRUCTION	1	ACXF55-04240	
	49	OPERATING INSTRUCTION	1	ACXF55-04250	
	50	INSTALLATION INSTRUCTION	1	ACXF60-04180	
	51	INSTALLATION INSTRUCTION	1	ACXF60-03260	

Note:

- All parts are supplied from PAPAMY, Malaysia (Vendor Code: 00029488) except (*).
- "O" marked parts are recommended to be kept in stock.
- (*) supplied by PCSE (Hamburg).

20.2 Outdoor Unit

20.2.1 WH-UQ09HE8 WH-UQ12HE8

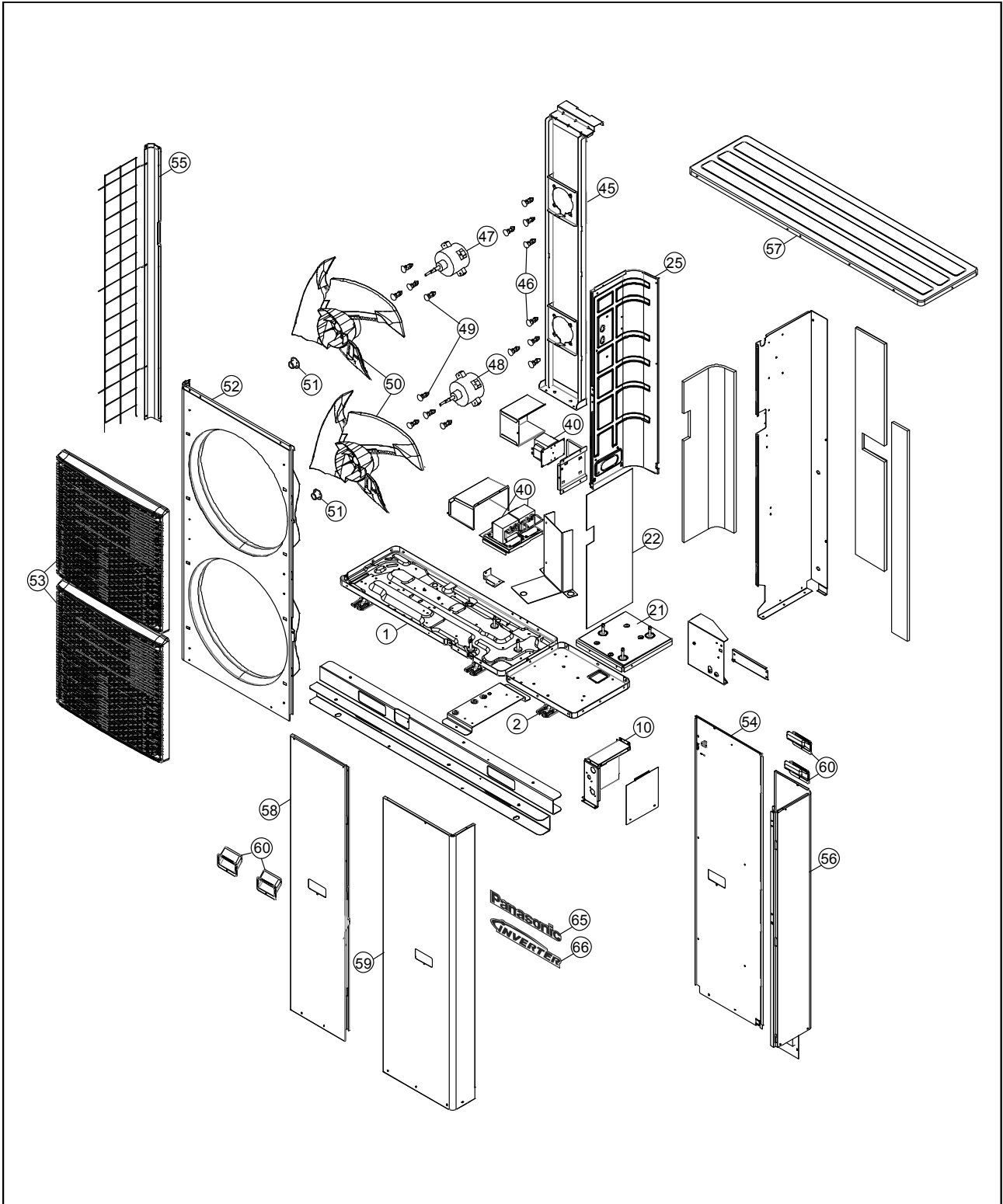

Note:

- The above exploded view is for the purpose of parts disassembly and replacement.
- The non-numbered parts are not kept as standard service parts.

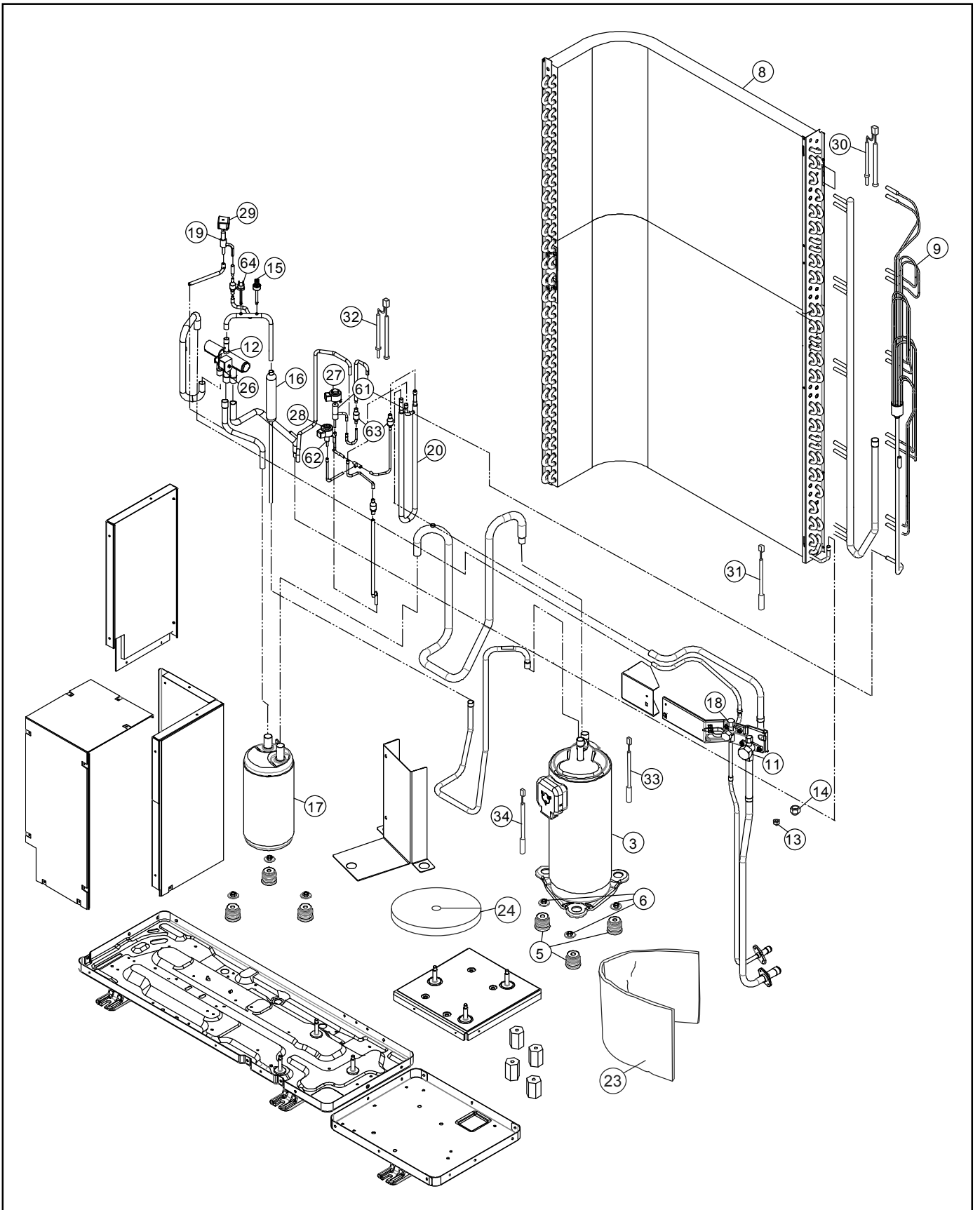

Note:

- The above exploded view is for the purpose of parts disassembly and replacement.
- The non-numbered parts are not kept as standard service parts.

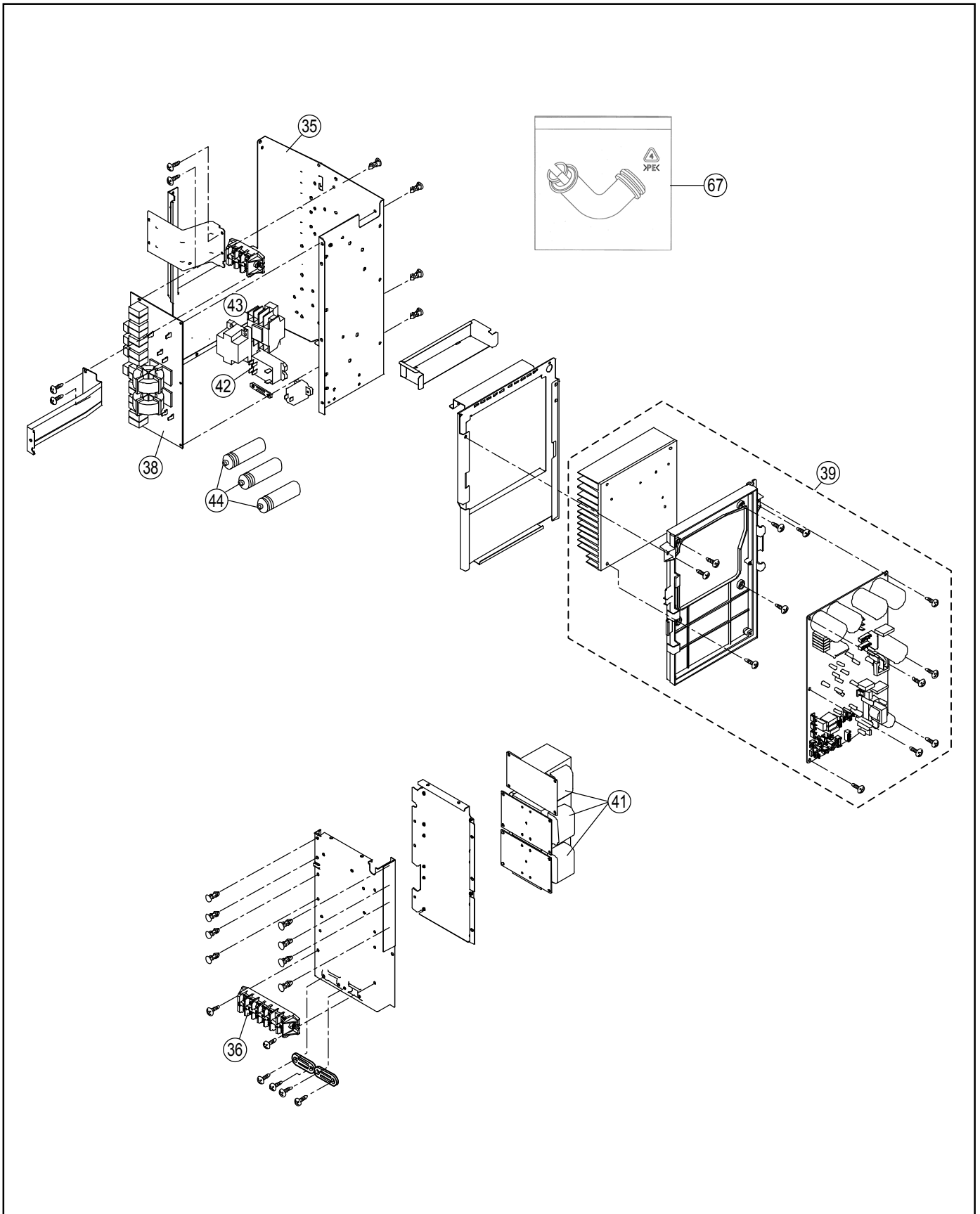

Note:

- The above exploded view is for the purpose of parts disassembly and replacement.
- The non-numbered parts are not kept as standard service parts.

<Model: WH-UQ09HE8 WH-UQ12HE8>

SAFETY	REF. NO.	DESCRIPTION & NAME	QTY.	WH-UQ09HE8	WH-UQ12HE8	REMARK
	1	BASE PAN ASS'Y	1	ACXD52K00240	←	
	2	BASE PAN ASS'Y	1	ACXD52K00250	←	
⚠	3	COMPRESSOR	1	5JD420XBA22	←	O
	5	BUSHING - COMPRESSOR MOUNT	3	CWH50055	←	
	6	NUT - COMPRESSOR MOUNT	3	CWH561049	←	
	8	CONDENSER COMPLETE	1	CWB32C3986	←	
	9	TUBE ASSY (CAP.TUBE)	1	CWT07K1606	←	
	10	HOLDER - COUPLING	1	ACXH35-00070	←	
	11	3 - WAYS VALVE (GAS)	1	CWB011700	←	O
	12	4 - WAYS VALVE	1	CWB001046	←	O
	13	FLARE NUT	1	CWT251061	←	
	14	FLARE NUT	1	CWT251064	←	
	15	HIGH PRESSURE SENSOR	1	CWA501463	←	O
	16	DISCHARGE MUFFLER	1	CWB121014	←	
	17	ACCUMULATOR	1	CWB131026A	←	
	18	3 - WAYS VALVE	1	ACXB01-00420	←	O
	19	2 - WAYS VALVE	1	CWB021637	←	O
	20	SUB COOLER TUBE HEAT	1	CWB361003	←	O
	21	SOUND PROOF MATERIAL	1	ACXG30-00710	←	
	22	SOUND PROOF MATERIAL	1	ACXG30-00800	←	
	23	SOUND PROOF MATERIAL	1	ACXG30-04700	←	
	24	SOUND PROOF MATERIAL	1	CWG302266	←	
	25	SOUND PROOF BOARD	1	CWH151243	←	
⚠	26	V-COIL COMPLETE (4-WAY VALVE)	1	CWA43C2169J	←	O
⚠	27	V-COIL COMPLETE (MAIN EXPANSION VALVE)	1	CWA43C2602	←	O
⚠	28	V-COIL COMPLETE (BYPASS EXPANSION VALVE)	1	CWA43C2335	←	O
⚠	29	V-COIL COMPLETE (2 WAY VALVE)	1	CWA43C2607	←	O
	30	SENSOR-COMP. (OUTDOOR AIR TEMP SENSOR)	1	CWA50C2730	←	O
	31	SENSOR-COMP. (DEFROST TEMP SENSOR)	1	CWA50C2577	←	O
	32	SENSOR-COMP. (BYPASS AND EVA EXIT TEMP)	1	CWA50C3165	←	O
	33	SENSOR-COMP. (DISCHARGE TEMP SENSOR)	1	ACXA50C00810	←	O
	34	SENSOR-COMP. (COMPRESSOR TANK TEMP)	1	ACXA50C00820	←	O
	35	CONTROL BOARD CASING	1	CWH10K1049	←	
⚠	36	TERMINAL BOARD ASS'Y	1	CWA28K1214	←	O
⚠	38	ELECTRONIC CONTROLLER - NF	1	CWA747838	←	O
⚠	39	ELECTRONIC CONTROLLER (MAIN)	1	ACXA73C21810R	ACXA73C21820R	O
⚠	40	REACTOR	3	G0C293J00001	←	O
⚠	41	REACTOR	3	G0C153J00009	←	O
⚠	42	ELECTRO MAGNETIC SWITCH	1	K6C2AGA00002	←	O
⚠	43	ELECTRO MAGNETIC SWITCH	1	K6C4E8A00001	←	O
⚠	44	CAPACITOR	3	DS441205NPQA	←	O
	45	FAN MOTOR BRACKET	1	CWD54K1084	←	
	46	SCREW - FAN MOTOR BRACKET	8	CWH551040J	←	
⚠	47	FAN MOTOR (UPPER)	1	EHDS83CAC	←	O
⚠	48	FAN MOTOR (LOWER)	1	EHDS83DAC	←	O
	49	SCREW - FAN MOTOR MOUNT	8	CWH551323	←	
	50	PROPELLER FAN ASSY	2	CWH00K1006	←	
	51	NUT	2	CWH561092	←	
	52	CABINET FRONT PLATE	1	CWE061098A	←	
	53	DISCHARGE GRILLE	2	CWE201073	←	
	54	CABINET REAR PLATE - COMPLETE	1	ACXE02C00050	←	
	55	CABINET SIDE PLATE ASSY	1	CWE04K1023A	←	
	56	CABINET SIDE PLATE - COMPLETE	1	ACXE04C00470	←	

SAFETY	REF. NO.	DESCRIPTION & NAME	QTY.	WH-UQ09HE8	WH-UQ12HE8	REMARK
	57	CABINET TOP PLATE CO.	1	CWE03C1105	←	
	58	CABINET FRONT PLATE CO.	1	ACXE06C00150	←	
	59	CABINET FRONT PLATE CO.	1	ACXE06C00160	←	
	60	HANDLE	4	CWE161010	←	
	61	EXPANSION VALVE (1)	1	CWB051049	←	O
	62	EXPANSION VALVE (2)	1	CWB051029	←	O
	63	STRAINER	2	CWB111032	←	
	64	PRESSURE SWITCH	1	CWA101007	←	O
	65	PANASONIC BADGE	1	CWE373439	←	
	66	INVERTER BADGE	1	CWE373441	←	
	67	ACCESSORY CO. (DRAIN ELBOW)	1	CWG87C900	←	

Note:

- All parts are supplied from PAPAMY, Malaysia (Vendor Code: 00029488).
- "O" marked parts are recommended to be kept in stock.

20.2.2 WH-UQ16HE8

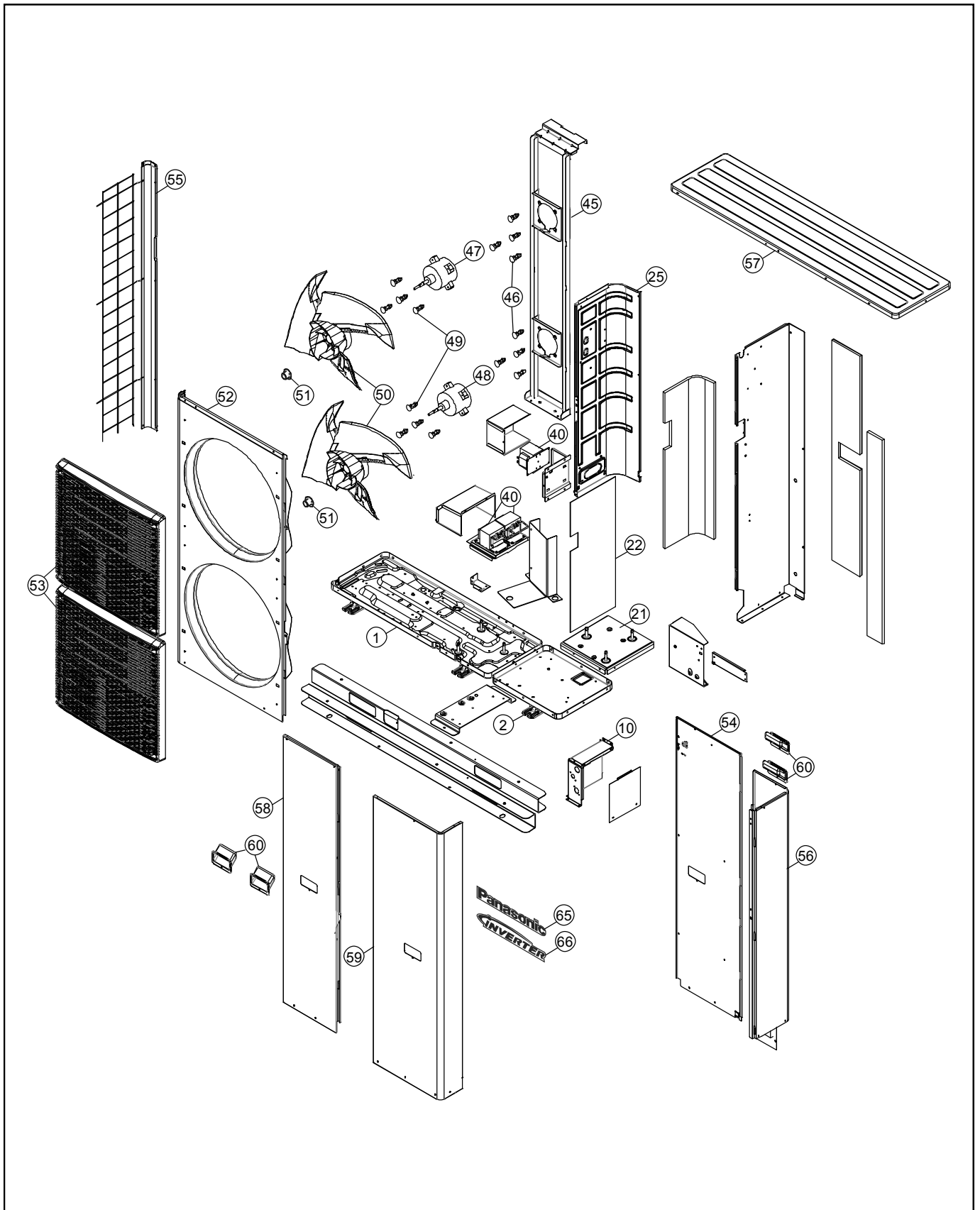

Note:

- The above exploded view is for the purpose of parts disassembly and replacement.
- The non-numbered parts are not kept as standard service parts.

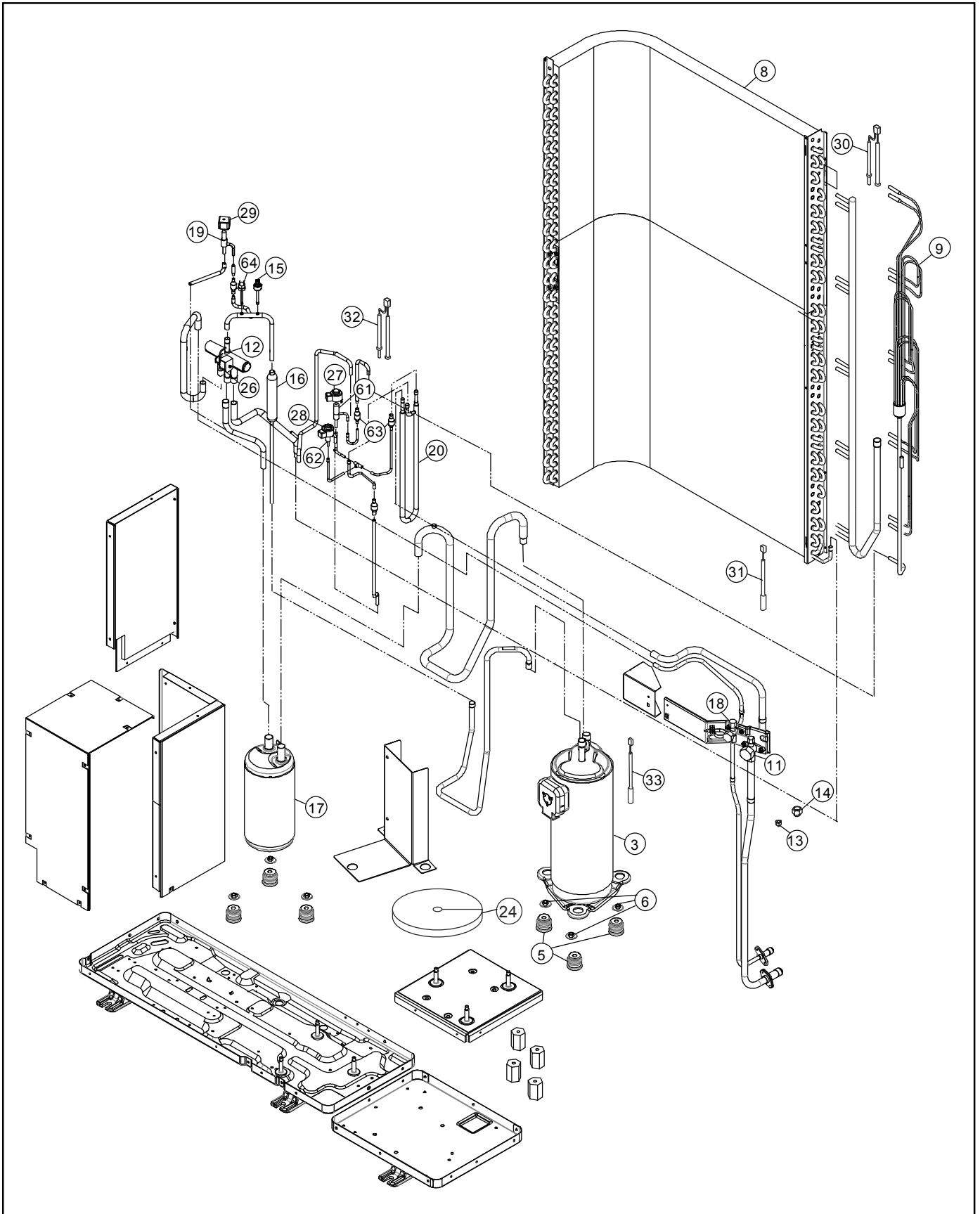

Note:

- The above exploded view is for the purpose of parts disassembly and replacement.
- The non-numbered parts are not kept as standard service parts.

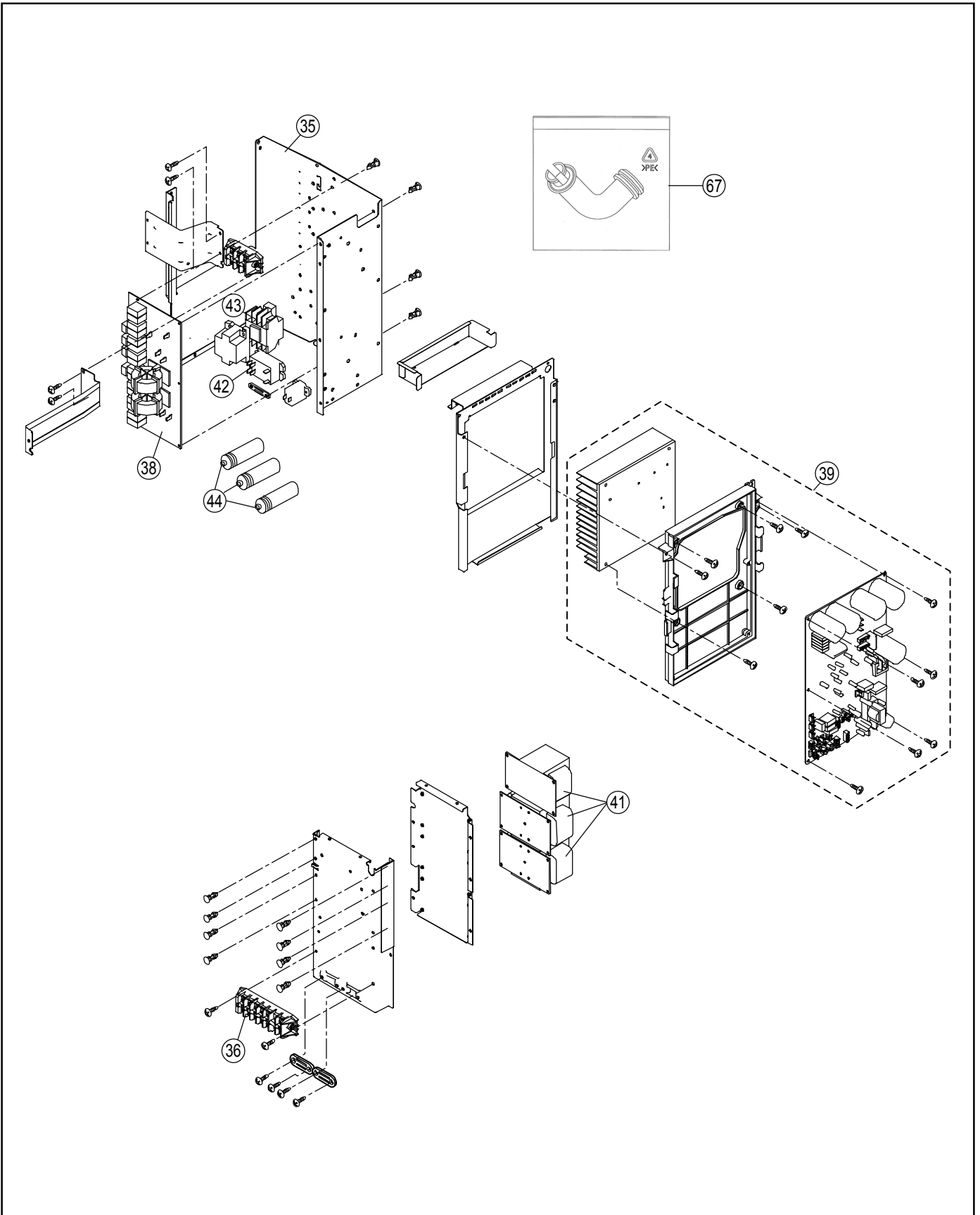

Note:

- The above exploded view is for the purpose of parts disassembly and replacement.
- The non-numbered parts are not kept as standard service parts.

<Model: WH-UQ16HE8>

SAFETY	REF. NO.	DESCRIPTION & NAME	QTY.	WH-UQ16HE8	REMARK
	1	BASE PAN ASS'Y	1	ACXD52K00240	
	2	BASE PAN ASS'Y	1	ACXD52K00250	
⚠	3	COMPRESSOR	1	5JD650XBA22	O
	5	BUSHING - COMPRESSOR MOUNT	3	CWH50055	
	6	NUT - COMPRESSOR MOUNT	3	CWH561049	
	8	CONDENSER COMPLETE	1	ACXB32C0001	
	9	TUBE ASSY (CAP.TUBE)	1	CWT07K1742	
	10	HOLDER - COUPLING	1	ACXH35-00070	
	11	3 - WAYS VALVE (GAS)	1	CWB011700	O
	12	4 - WAYS VALVE	1	CWB001046	O
	13	FLARE NUT	1	CWT251061	
	14	FLARE NUT	1	CWT251064	
	15	HIGH PRESSURE SENSOR	1	CWA501463	O
	16	DISCHARGE MUFFLER	1	CWB121014	
	17	ACCUMULATOR	1	CWB131026A	
	18	3 - WAYS VALVE	1	ACXB01-00420	O
	19	2 - WAYS VALVE	1	CWB021637	O
	20	SUB COOLER TUBE HEAT	1	CWB361003	O
	21	SOUND PROOF MATERIAL	1	ACXG30-00720	
	22	SOUND PROOF MATERIAL	1	ACXG30-00800	
	24	SOUND PROOF MATERIAL	1	CWG302266	
	25	SOUND PROOF BOARD	1	CWH151243	
⚠	26	V-COIL COMPLETE (4-WAY VALVE)	1	CWA43C2169J	O
⚠	27	V-COIL COMPLETE (MAIN EXPANSION VALVE)	1	CWA43C2602	O
⚠	28	V-COIL COMPLETE (BYPASS EXPANSION VALVE)	1	CWA43C2335	O
⚠	29	V-COIL COMPLETE (2 WAY VALVE)	1	CWA43C2607	O
	30	SENSOR-COMP. (OUTDOOR AIR TEMP SENSOR)	1	CWA50C2730	O
	31	SENSOR-COMP. (DEFROST TEMP SENSOR)	1	CWA50C2577	O
	32	SENSOR-COMP. (BYPASS AND EVA EXIT TEMP)	1	CWA50C3165	O
	33	SENSOR-COMP. (DISCHARGE TEMP SENSOR)	1	ACXA50C00810	O
	35	CONTROL BOARD CASING	1	CWH10K1228	
⚠	36	TERMINAL BOARD ASS'Y	1	CWA28K1214	O
⚠	38	ELECTRONIC CONTROLLER - NF	1	CWA747735	O
⚠	39	ELECTRONIC CONTROLLER (MAIN)	1	ACXA73C21830R	O
⚠	40	REACTOR	3	G0C213J00001	O
⚠	41	REACTOR	3	G0C353J00001	O
⚠	42	ELECTRO MAGNETIC SWITCH	1	K6C2AGA00002	O
⚠	43	ELECTRO MAGNETIC SWITCH	1	K6C4E8A00001	O
⚠	44	CAPACITOR	3	DS451605DPQB	O
	45	FAN MOTOR BRACKET	1	CWD54K1024	
	46	SCREW - FAN MOTOR BRACKET	8	CWH551040J	
⚠	47	FAN MOTOR (UPPER)	1	EHDS83CAC	O
⚠	48	FAN MOTOR (LOWER)	1	EHDS83DAC	O
	49	SCREW - FAN MOTOR MOUNT	8	CWH551323	
	50	PROPELLER FAN ASSY	2	CWH00K1006	
	51	NUT	2	CWH561092	
	52	CABINET FRONT PLATE	1	CWE061098A	
	53	DISCHARGE GRILLE	2	CWE201073	
	54	CABINET REAR PLATE - COMPLETE	1	ACXE02C00050	
	55	CABINET SIDE PLATE ASSY	1	CWE04K1023A	
	56	CABINET SIDE PLATE - COMPLETE	1	ACXE04C00470	
	57	CABINET TOP PLATE CO.	1	CWE03C1105	
	58	CABINET FRONT PLATE CO.	1	ACXE06C00150	

SAFETY	REF. NO.	DESCRIPTION & NAME	QTY.	WH-UQ16HE8	REMARK
	59	CABINET FRONT PLATE CO.	1	ACXE06C00160	
	60	HANDLE	4	CWE161010	
	61	EXPANSION VALVE (1)	1	CWB051049	O
	62	EXPANSION VALVE (2)	1	CWB051029	O
	63	STRAINER	2	CWB111032	
	64	PRESSURE SWITCH	1	CWA101007	O
	65	PANASONIC BADGE	1	CWE373439	
	66	INVERTER BADGE	1	CWE373441	
	67	ACCESSORY CO. (DRAIN ELBOW)	1	CWG87C900	

Note:

- All parts are supplied from PAPAMY, Malaysia (Vendor Code: 00029488).
- "O" marked parts are recommended to be kept in stock.

20.2.3 WH-UX09HE8 WH-UX12HE8

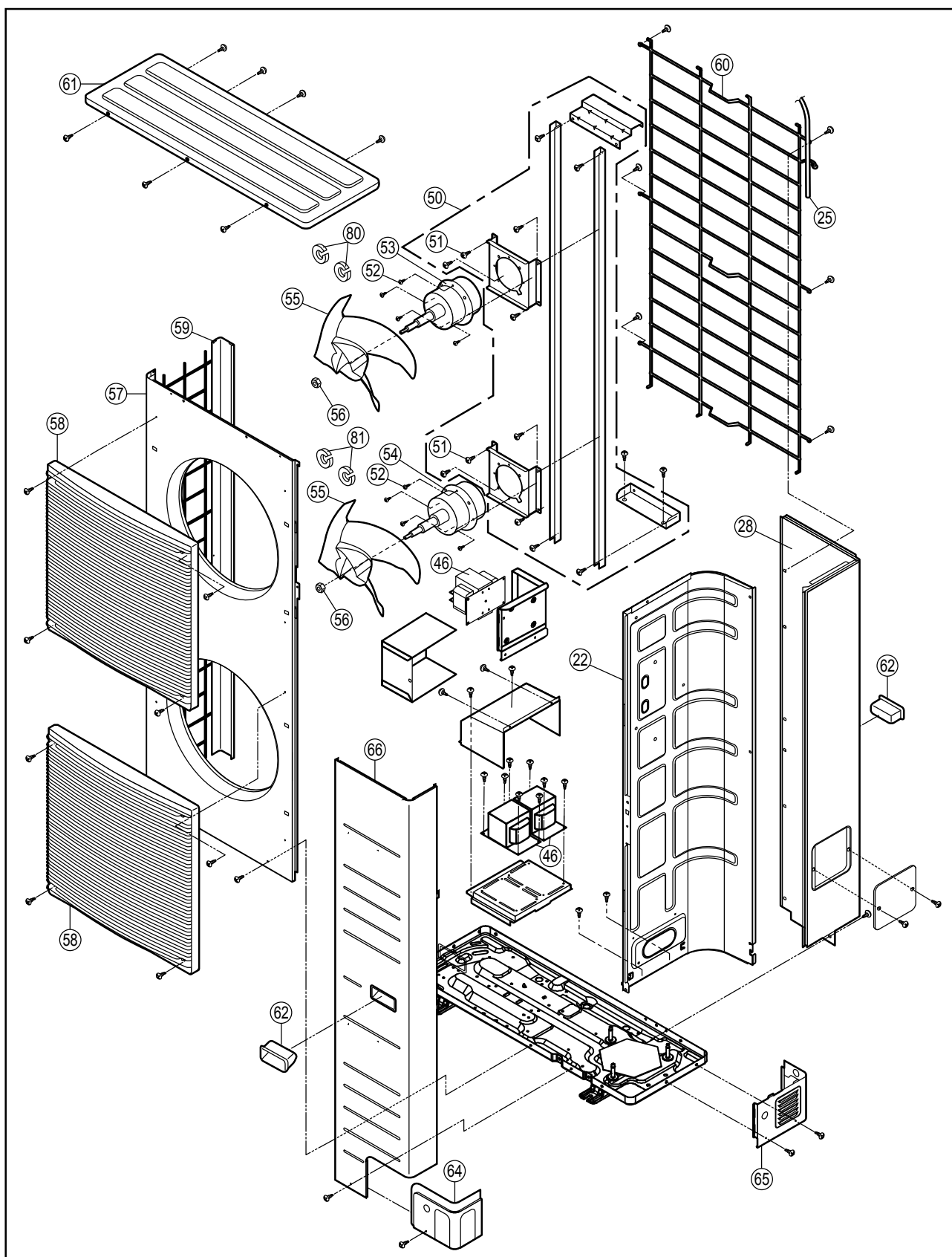

Note:

- The above exploded view is for the purpose of parts disassembly and replacement.
- The non-numbered parts are not kept as standard service parts.

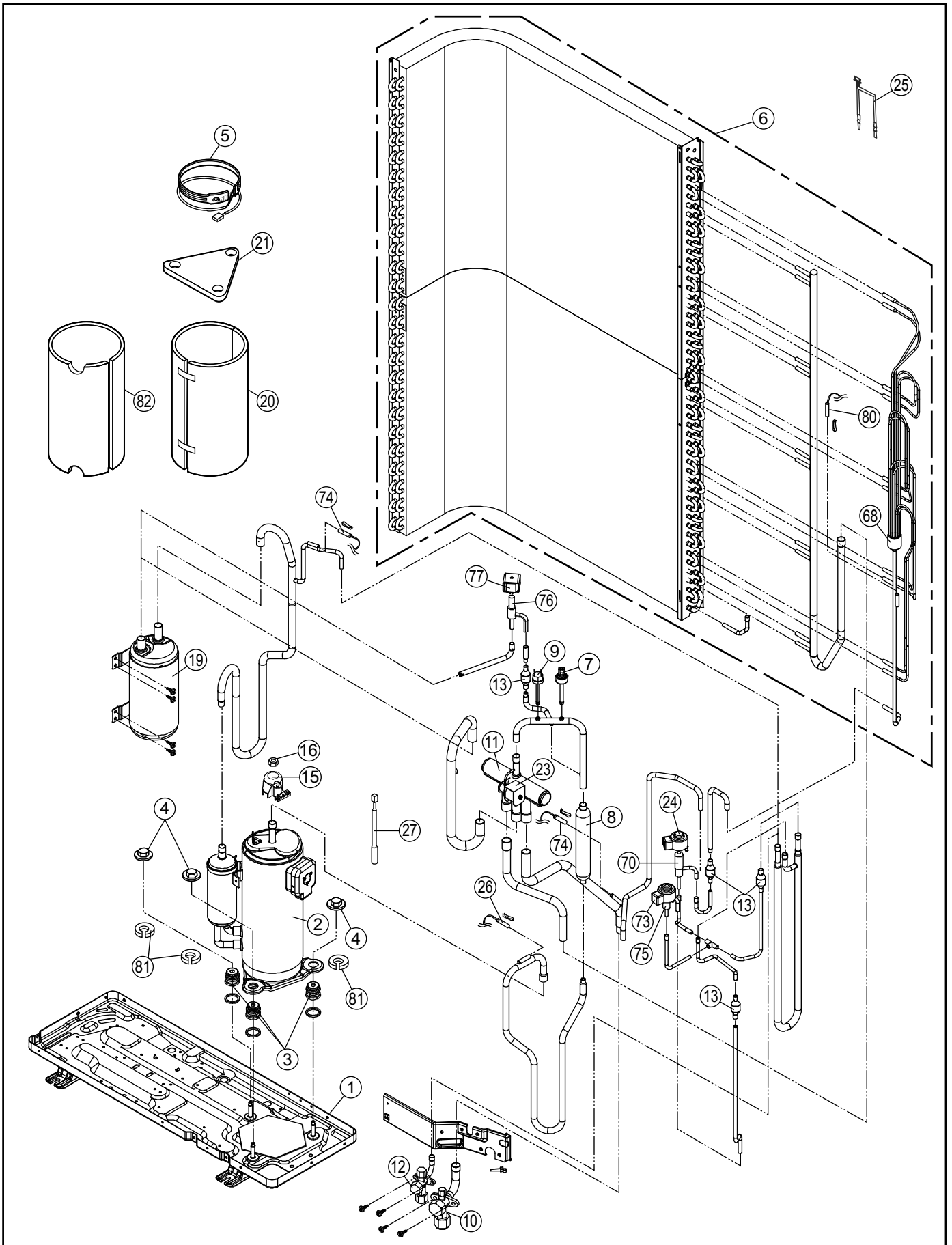

Note:

- The above exploded view is for the purpose of parts disassembly and replacement.
- The non-numbered parts are not kept as standard service parts.

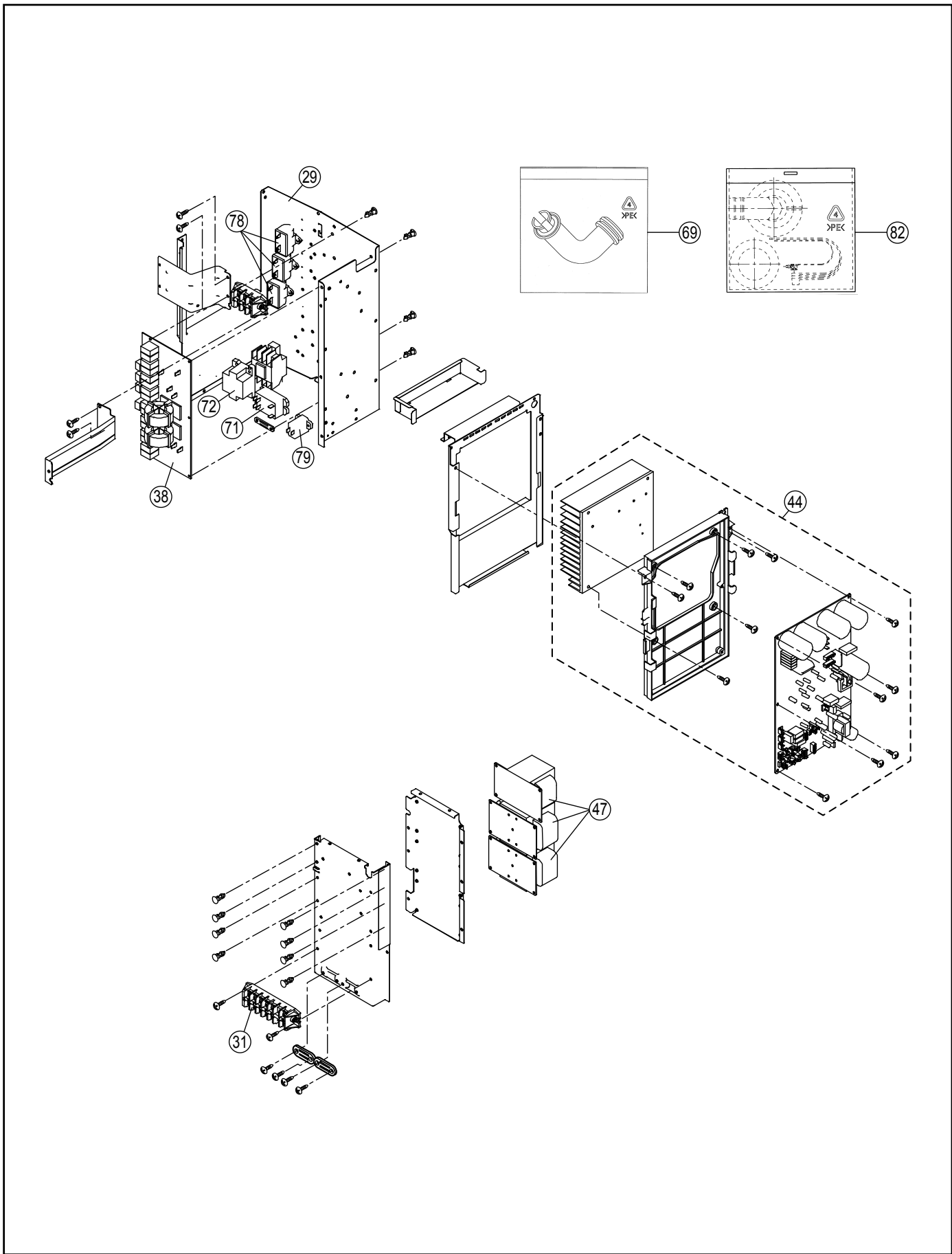

Note:

- The above exploded view is for the purpose of parts disassembly and replacement.
- The non-numbered parts are not kept as standard service parts.

<Model: WH-UX09HE8 WH-UX12HE8>

SAFETY	REF. NO.	DESCRIPTION & NAME	QTY.	WH-UX09HE8	WH-UX12HE8	REMARK
	1	BASE PAN ASS'Y	1	ACXD52K00260	←	
⚠	2	COMPRESSOR	1	5JD420XBA22	←	O
	3	BUSHING - COMPRESSOR MOUNT	3	CWH50055	←	
	4	NUT-COMPRESSOR MOUNT	3	CWH561049	←	
	5	CRANKCASE HEATER	1	ACXA34-00110	←	
	6	CONDENSER COMPLETE	1	CWB32C3986	←	
	7	HIGH PRESSURE SENSOR	1	CWA501463	←	O
	8	DISCHARGE MUFFLER	1	CWB121014	←	
	9	PRESSURE SWITCH	1	CWA101013	←	O
	10	3-WAYS VALVE (GAS)	1	CWB011251	←	O
	11	4-WAYS VALVE	1	CWB001046	←	O
	12	3-WAYS VALVE (LIQUID)	1	ACXB01-00040	←	O
	13	STRAINER	4	CWB111032	←	
	15	TERMINAL COVER	1	CWH171039A	←	
	16	NUT-TERMINAL COVER	1	CWH7080300J	←	
	19	ACCUMULATOR	1	CWB131026A	←	
	20	SOUND PROOF MATERIAL	1	ACXG30-00850	←	
	21	SOUND PROOF MATERIAL	1	CWG302266	←	
	22	SOUND PROOF BOARD	1	CWH15K1031	←	
⚠	23	V-COIL CO. (4-WAY VALVE) CN-HOT	1	CWA43C2169J	←	O
⚠	24	V-COIL CO. (MAIN EXP VALVE) CN-EV1	1	CWA43C2602	←	O
	25	SENSOR -C OMP. (OUTDOOR AIR PIPE) CN-TH1	1	CWA50C2730	←	O
	26	SENSOR - COMP. (DISCHARGE)	1	CWA50C2576	←	O
	27	SENSOR - TANK	1	CWA50C2629	←	O
	28	CABINET REAR PLATE - COMPLETE	1	CWE02C1064	←	
	29	CONTROL BOARD CASING	1	CWH10K1049	←	
⚠	31	TERMINAL BOARD ASS'Y	1	CWA28K1214	←	O
⚠	38	ELECTRONIC CONTROLLER - NF	1	CWA747838	←	O
⚠	44	ELECTRONIC CONTROLLER (MAIN)	1	ACXA73C08120R	ACXA73C08130R	O
⚠	46	REACTOR	3	G0C293J00001	←	O
⚠	47	REACTOR	3	G0C153J00009	←	O
⚠	50	FAN MOTOR BRACKET	1	CWD54K1084	←	
	51	SCREW-FAN MOTOR BRACKET	8	CWH551040J	←	
	52	SCREW-FAN MOTOR MOUNT	8	CWH551323	←	
	53	FAN MOTOR (UPPER)	1	EHDS83CAC	←	O
	54	FAN MOTOR (LOWER)	1	EHDS83DAC	←	O
	55	PROPELLER FAN ASSY	2	CWH00K1006	←	
	56	NUT	2	CWH561092	←	
	57	CABINET FRONT PLATE	1	CWE061098A	←	
	58	DISCHARGE GRILLE	2	CWE201073	←	
	59	CABINET SIDE PLATE ASSY	1	CWE04K1023A	←	
	61	CABINET TOP PLATE CO.	1	CWE03C1096	←	
	62	HANDLE	2	CWE161008	←	
	64	PIPE COVER (FRONT)	1	CWD601074A	←	
	65	PIPE COVER (BACK)	1	CWD601075A	←	
	66	CABINET FRONT PLATE CO.	1	CWE06C1091	←	
	68	TUBE ASSY (CAP.TUBE)	1	CWT07K1606	←	
	69	ACCESSORY CO. (DRAIN ELBOW)	1	CWG87C900	←	
	70	EXPANSION VALVE	1	CWB051049	←	
	71	ELECTRO MAGNETIC SWITCH	1	K6C2AGA00002	←	O
	72	ELECTRO MAGNETIC SWITCH	1	K6C4E8A00001	←	O
⚠	73	V-COIL CO. (BYPASS EXP VALVE) CN-EV2	1	CWA43C2335	←	O
	74	SENSOR- COMP. (BYPASS, EVA EXIT TEMP) CN-TH3	1	CWA50C3165	←	O

SAFETY	REF. NO.	DESCRIPTION & NAME	QTY.	WH-UX09HE8	WH-UX12HE8	REMARK
	75	EXPANSION VALVE	1	CWB051029	←	O
	76	2-WAYS VALVE	1	CWB021637	←	O
⚠	77	V-COIL CO. (2 WAY VALVE) CN-V1	1	CWA43C2607	←	O
⚠	78	CAPACITOR - FM (3.5MF/440V)	3	DS441205NPQA	←	O
	79	PTC THERMISTORS	1	D4DDG1010001	←	O
	80	SENSOR - COMP. (DEFROST TEMP) CN-TH2	1	CWA50C2577	←	O
	81	GASKET FOR TERMINAL COVER	3	CWB811017	←	
	82	ACCESSORY - COMPLETE	1	CWH82C2031	←	

Note:

- All parts are supplied from PAPAMY, Malaysia (Vendor Code: 00029488).
- "O" marked parts are recommended to be kept in stock.

20.2.4 WH-UX16HE8

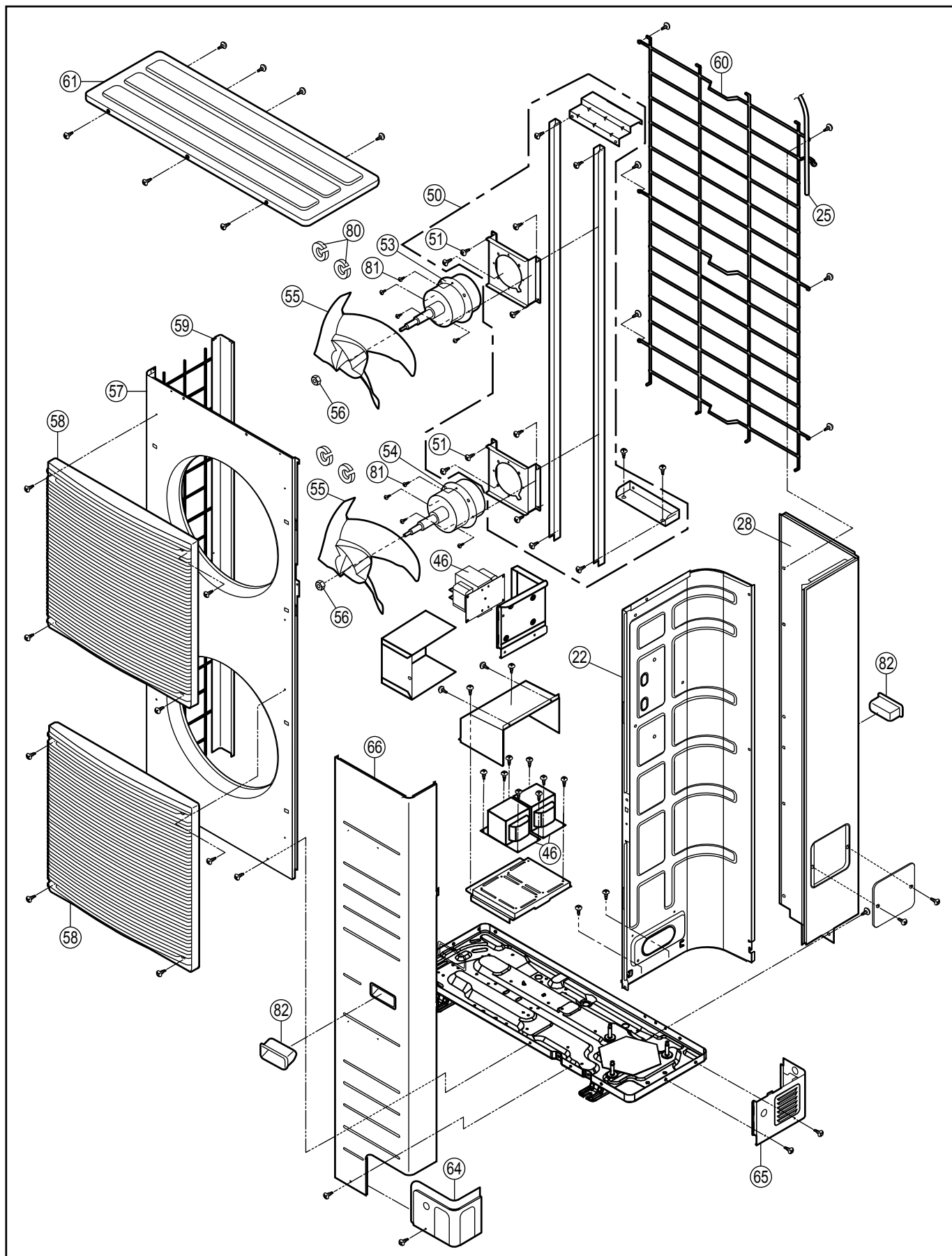

Note:

- The above exploded view is for the purpose of parts disassembly and replacement.
- The non-numbered parts are not kept as standard service parts.

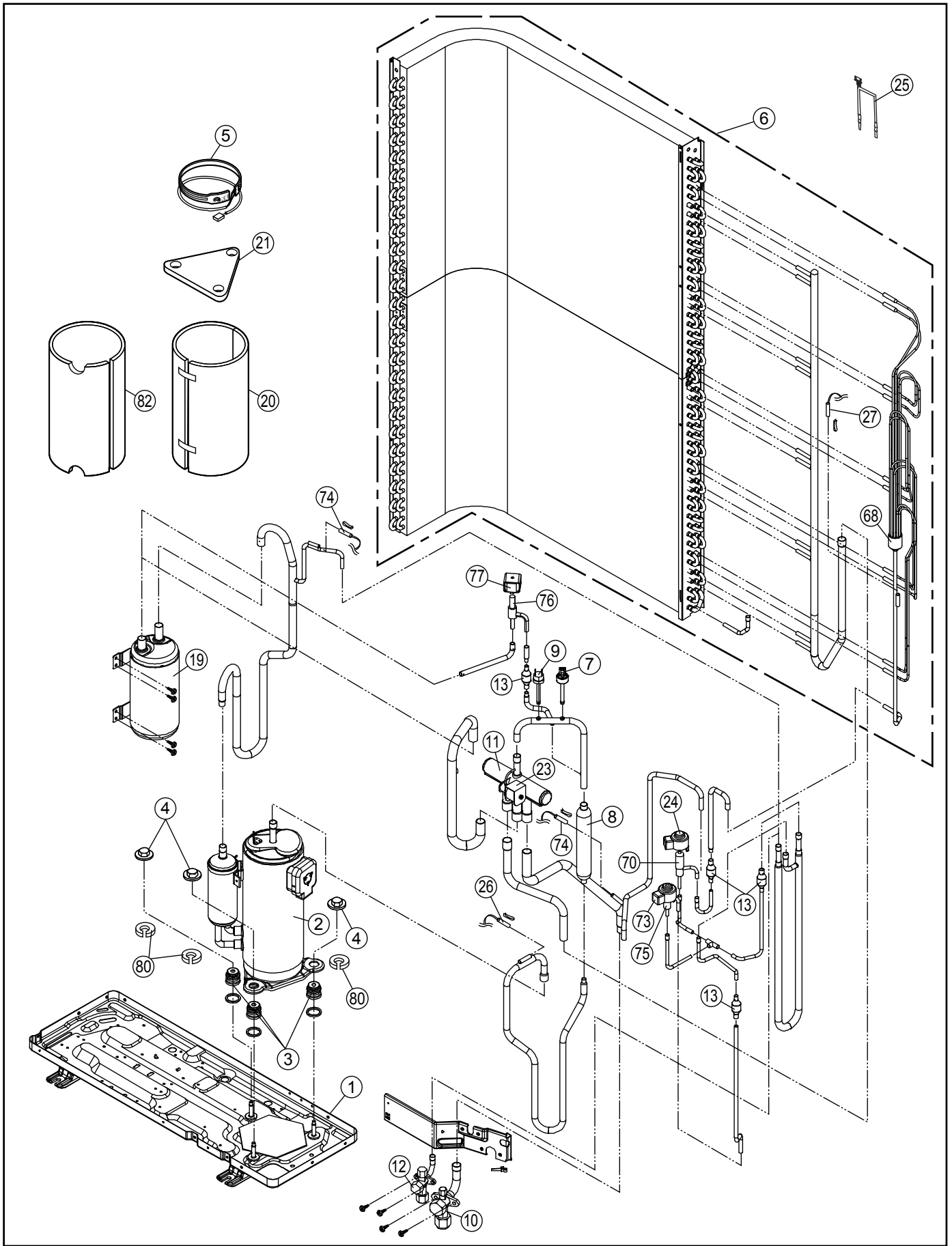

Note:

- The above exploded view is for the purpose of parts disassembly and replacement.
- The non-numbered parts are not kept as standard service parts.

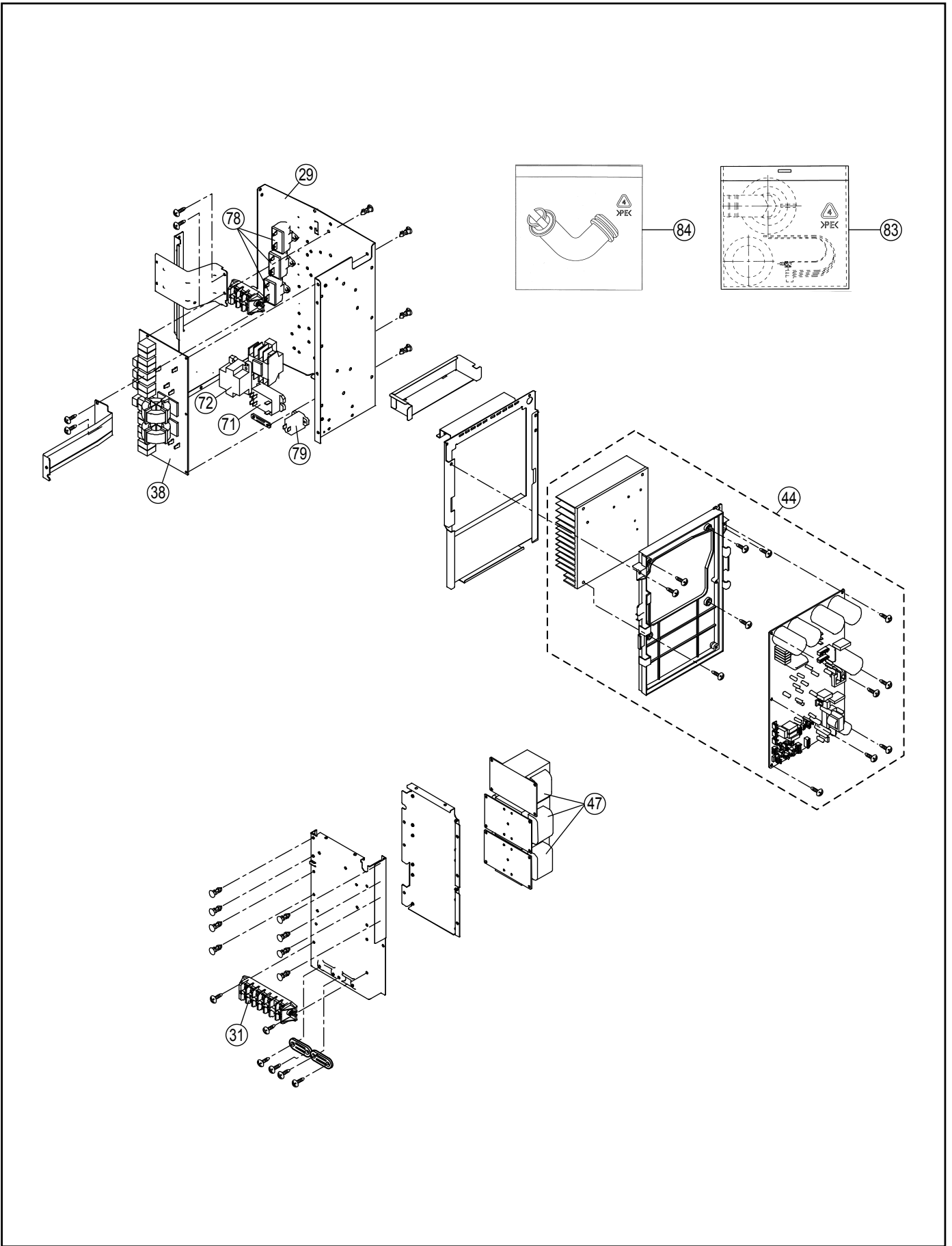

Note:

- The above exploded view is for the purpose of parts disassembly and replacement.
- The non-numbered parts are not kept as standard service parts.

<Model: WH-UX16HE8>

SAFETY	REF. NO.	DESCRIPTION & NAME	QTY.	WH-UX16HE8	REMARK
	1	BASE PAN ASS'Y	1	ACXD52K00260	
△	2	COMPRESSOR	1	5JD650XBA22	O
	3	BUSHING - COMPRESSOR MOUNT	3	CWH50055	
	4	NUT-COMPRESSOR MOUNT	3	CWH561049	
	5	CRANKCASE HEATER	1	ACXA34-00110	
	6	CONDENSER COMPLETE	1	ACXB32C0001	
	7	HIGH PRESSURE SENSOR	1	CWA501463	O
	8	DISCHARGE MUFFLER	1	CWB121014	
	9	PRESSURE SWITCH	1	CWA101013	O
	10	3-WAYS VALVE (GAS)	1	CWB011251	O
	11	4-WAYS VALVE	1	CWB001046	O
	12	3-WAYS VALVE (LIQUID)	1	ACXB01-00040	O
	13	STRAINER	4	CWB111032	
	19	ACCUMULATOR	1	CWB131026A	
	20	SOUND PROOF MATERIAL	1	CWG302795	
	21	SOUND PROOF MATERIAL	1	CWG302266	
	22	SOUND PROOF BOARD	1	CWH15K1031	
△	23	V-COIL CO. (4-WAY VALVE) CN-HOT	1	CWA43C2169J	O
△	24	V-COIL CO. (MAIN EXP VALVE) CN-EV1	1	CWA43C2602	O
	25	SENSOR - COMP. (OUTDOOR AIR PIPE) CN-TH1	1	CWA50C2730	O
	26	SENSO R- COMP. (DISCHARGE)	1	CWA50C2576	O
	27	SENSOR - COMP. (DEFROST TEMP) CN-TH2	1	CWA50C2577	O
	28	CABINET REAR PLATE - COMPLETE	1	CWE02C1077	
	29	CONTROL BOARD CASING	1	CWH10K1228	
△	31	TERMINAL BOARD ASS'Y	1	CWA28K1214	O
△	38	ELECTRONIC CONTROLLER - NF	1	CWA747735	O
△	44	ELECTRONIC CONTROLLER (MAIN)	1	ACXA73C08140R	O
△	46	REACTOR	3	G0C213J00001	O
△	47	REACTOR	3	G0C353J00001	O
△	50	FAN MOTOR BRACKET	1	CWD54K1024	
	51	SCREW-FAN MOTOR BRACKET	8	CWH551040J	
	53	FAN MOTOR (UPPER)	1	EHDS83CAC	O
	54	FAN MOTOR (LOWER)	1	EHDS83DAC	O
	55	PROPELLER FAN ASSY	2	CWH00K1006	
	56	NUT	2	CWH561092	
	57	CABINET FRONT PLATE	1	CWE061098A	
	58	DISCHARGE GRILLE	2	CWE201073	
	59	CABINET SIDE PLATE ASSY	1	CWE04K1023A	
	61	CABINET TOP PLATE CO.	1	CWE03C1096	
	64	PIPE COVER (FRONT)	1	CWD601074A	
	65	PIPE COVER (BACK)	1	CWD601075A	
	66	CABINET FRONT PLATE CO.	1	CWE06C1091	
	68	TUBE ASSY (CAP.TUBE)	1	CWT07K1742	
	70	EXPANSION VALVE	1	CWB051049	
	71	ELECTRO MAGNETIC SWITCH	1	K6C2AGA00002	O
	72	ELECTRO MAGNETIC SWITCH	1	K6C4E8A00001	O
△	73	V-COIL CO. (BYPASS EXP VALVE) CN-EV2	1	CWA43C2335	O
	74	SENSOR - COMP. (BYPASS, EVA EXIT TEMP) CN-TH3	1	CWA50C2807	O
	75	EXPANSION VALVE	1	CWB051029	O
	76	2-WAYS VALVE	1	CWB021637	O
△	77	V-COIL CO. (2 WAY VALVE) CN-V1	1	CWA43C2607	O
△	78	CAPACITOR - FM (3.5MF/440V)	3	DS451605DPQB	O
	79	PTC THERMISTORS	1	D4DDG1010001	O

SAFETY	REF. NO.	DESCRIPTION & NAME	QTY.	WH-UX16HE8	REMARK
	80	GASKET FOR TERMINAL COVER	3	CWB811017	
	81	SCREW - FAN MOTOR MOUNT	8	CWH551323	
	82	HANDLE	2	CWE161008	
	83	ACCESSORY - COMPLETE	1	CWH82C2031	
	84	ACCESSORY CO. (DRAIN ELBOW)	1	CWG87C900	

Note:

- All parts are supplied from PAPAMY, Malaysia (Vendor Code: 00029488).
- "O" marked parts are recommended to be kept in stock.

20.2.5 WH-UD09HE8 WH-UD12HE8 WH-UD16HE8

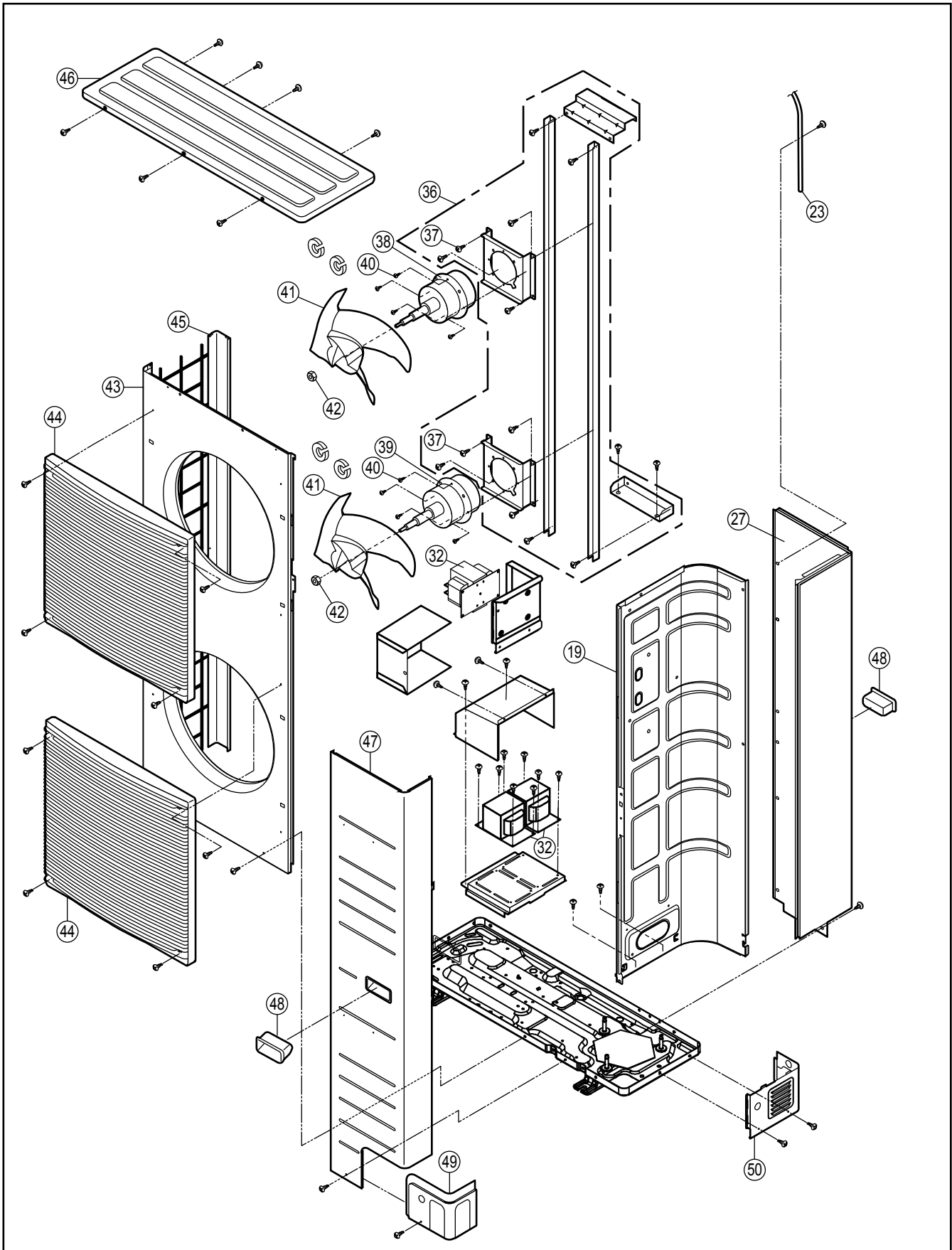

Note:

- The above exploded view is for the purpose of parts disassembly and replacement.
- The non-numbered parts are not kept as standard service parts.

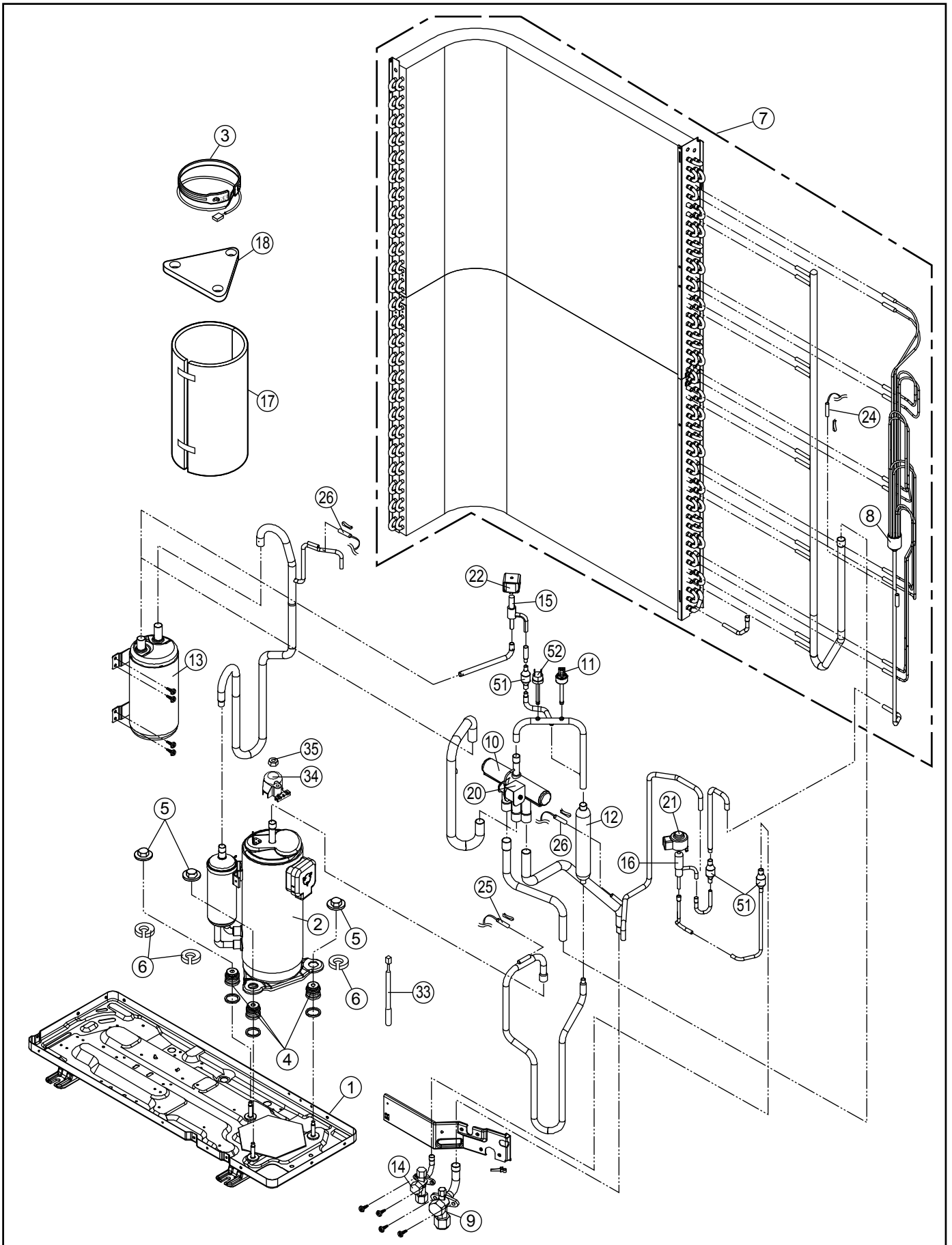

Note:

- The above exploded view is for the purpose of parts disassembly and replacement.
- The non-numbered parts are not kept as standard service parts.

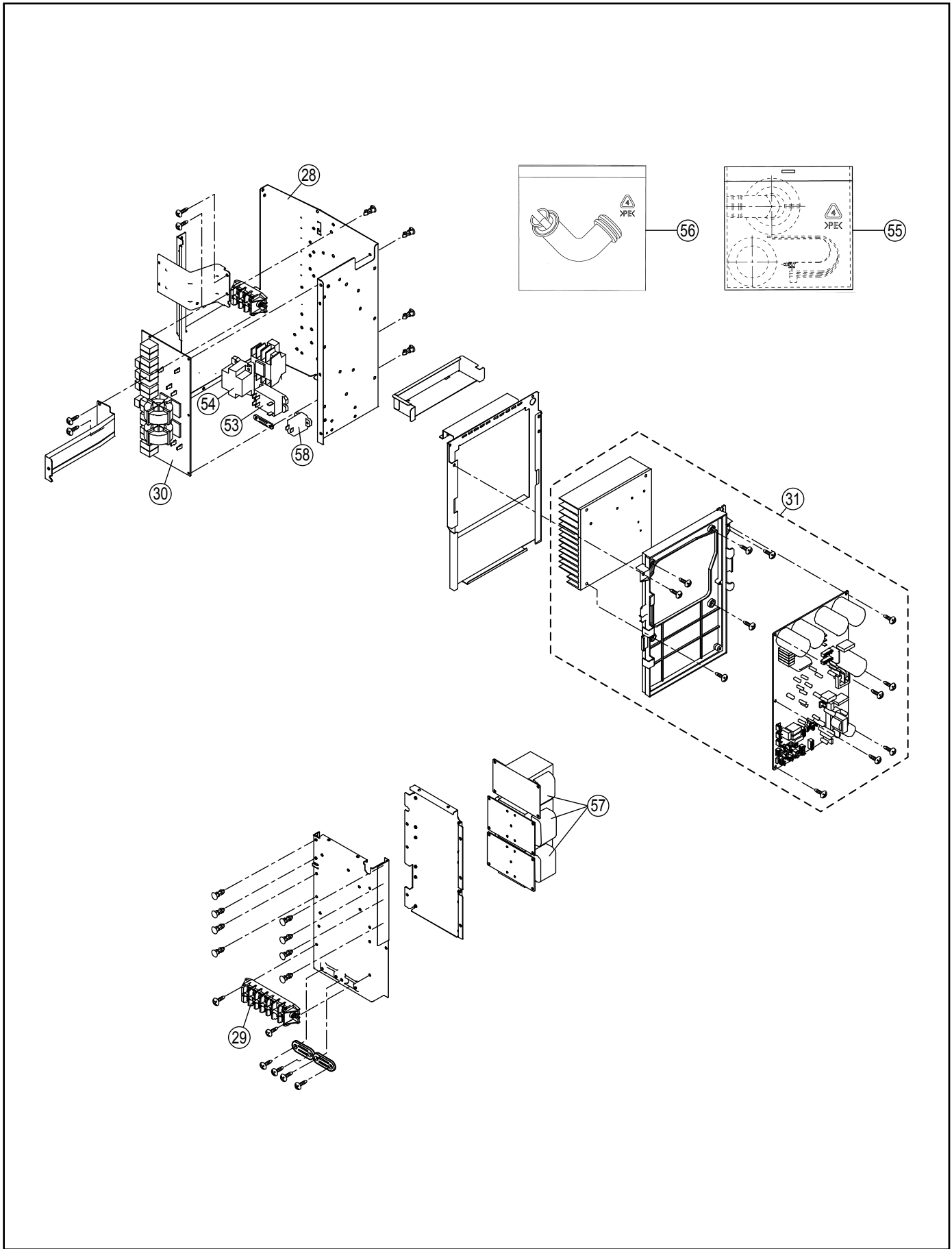

Note:

- The above exploded view is for the purpose of parts disassembly and replacement.
- The non-numbered parts are not kept as standard service parts.

<Model: WH-UD09HE8 WH-UD12HE8 WH-UD16HE8>

SAFETY	REF. NO.	DESCRIPTION & NAME	QTY.	WH-UD09HE8	WH-UD12HE8	WH-UD16HE8	REMARK
	1	BASE PAN ASS'Y	1	ACXD52K00260	←	←	
⚠	2	COMPRESSOR	1	5JD420XBA22	←	←	O
	3	CRANKCASE HEATER	1	CWA341053	←	←	
	4	BUSHING - COMPRESSOR MOUNT	3	CWH50055	←	←	
	5	NUT - COMPRESSOR MOUNT	3	CWH561049	←	←	
	6	GASKET FOR TERMINAL COVER	3	CWB811017	←	←	
	7	CONDENSER COMPLETE	1	CWB32C3986	←	←	
	8	TUBE ASSY (CAP.TUBE)	1	CWT07K1606	←	←	
	9	3-WAYS VALVE (GAS)	1	CWB011251	←	←	O
	10	4-WAYS VALVE	1	CWB001046	←	←	O
	11	HIGH PRESSURE SENSOR	1	CWA501463	←	←	O
	12	DISCHARGE MUFFLER	1	CWB121014	←	←	
	13	ACCUMULATOR	1	CWB131026A	←	←	
	14	3-WAYS VALVE	1	ACXB01-00040	←	←	O
	15	2-WAYS VALVE	1	CWB021637	←	←	O
	16	EXPANSION VALVE	1	CWB051049	←	←	
	17	SOUND PROOF MATERIAL	1	ACXG30-00850	←	←	
	18	SOUND PROOF MATERIAL	1	CWG302266	←	←	
	19	SOUND PROOF BOARD	1	CWH15K1031	←	←	
⚠	20	V-COIL COMP. (4-WAY VALVE)	1	CWA43C2169J	←	←	O
⚠	21	V-COIL COMP. (EXPANSION VALVE)	1	CWA43C2602	←	←	O
⚠	22	V-COIL COMP. (2 WAY VALVE)	1	CWA43C2607	←	←	O
	23	SENSOR - COMP. (OUTDOOR AIR PIPE TEMP CN-TH1)	1	CWA50C2730	←	←	O
	24	SENSOR - COMP. (DEFROST TEMO CN-TH2)	1	CWA50C2577	←	←	O
	25	SENSOR-COMP. (DISCHARGE TEMP CN-DIS)	1	CWA50C2576	←	←	O
	26	SENSOR - COMP. (EVA EXIT TEMP CN-TH3)	1	CWA50C3204	←	←	O
	27	CABINET REAR PLATE-COMplete	1	CWE02C1059	←	←	
	28	CONTROL BOARD CASING	1	CWH10K1049	←	←	
⚠	29	TERMINAL BOARD ASS'Y	1	CWA28K1214	←	←	O
⚠	30	ELECTRONIC CONTROLLER - NF	1	CWA747838	←	←	O
⚠	31	ELECTRONIC CONTROLLER (MAIN)	1	ACXA73C08820R	ACXA73C08830R	ACXA73C08840R	O
⚠	32	REACTOR	3	G0C293J00001	←	←	O
	33	SENSOR - (COMP TANK TEMP CN-TANK)	1	CWA50C2629	←	←	O
	34	TERMINAL COVER	1	CWH171039A	←	←	
	35	NUT-TERMINAL COVER	1	CWH7080300J	←	←	
	36	FAN MOTOR BRACKET	1	CWD54K1084	←	←	
	37	SCREW-FAN MOTOR BRACKET	8	CWH551040J	←	←	
⚠	38	FAN MOTOR (UPPER)	1	EHDS83CAC	←	←	O
⚠	39	FAN MOTOR (LOWER)	1	EHDS83DAC	←	←	O
	40	SCREW - FAN MOTOR MOUNT	8	CWH551323	←	←	
	41	PROPELLER FAN ASSY	2	CWH00K1006	←	←	
	42	NUT	2	CWH561092	←	←	
	43	CABINET FRONT PLATE	1	CWE061098A	←	←	
	44	DISCHARGE GRILLE	2	CWE201073	←	←	
	45	CABINET SIDE PLATE ASSY	1	CWE04K1023A	←	←	

SAFETY	REF. NO.	DESCRIPTION & NAME	QTY.	WH-UD09HE8	WH-UD12HE8	WH-UD16HE8	REMARK
	45	CABINET SIDE PLATE ASSY	1	CWE04K1023A	←	←	
	46	CABINET TOP PLATE CO.	1	CWE03C1096	←	←	
	47	CABINET FRONT PLATE CO.	1	CWE06C1091	←	←	
	48	HANDLE	2	CWE161008	←	←	
	49	PIPE COVER (FRONT)	1	CWD601074A	←	←	
	50	PIPE COVER (BACK)	1	CWD601075A	←	←	
	51	STRAINER	2	CWB111032	←	←	
	52	PRESSURE SWITCH	1	CWA101013	←	←	O
⚠	53	ELECTRO MAGNETIC SWITCH	1	K6C2AGA00002	←	←	O
⚠	54	ELECTRO MAGNETIC SWITCH	1	K6C4E8A00001	←	←	O
	55	ACCESSORY - COMPLETE	1	CWH82C2031	←	←	
	56	ACCESSORY CO. (DRAIN ELBOW)	1	CWG87C900	←	←	
⚠	57	REACTOR	3	G0C153J00009	←	←	O
	58	PTC THERMISTORS	1	D4DDG1010001	←	←	O

Note:

- All parts are supplied from PAPAMY, Malaysia (Vendor Code: 00029488).
- "O" marked parts are recommended to be kept in stock.