

Features of your new air conditioner

Cool Summer Offer

On those hot sweltering summer days and long restless nights, there is no better escape from the heat than the cool comforts of home. Your new air conditioner brings an end to exhausting hot summer days and lets you rest.

This summer, beat the heat with your own air conditioner.

Cost Efficient System

Your new air conditioner not only provides maximum cooling power in the summer, but can also be an efficient heating method in the winter with the advanced "Heat pump" system. This technology is up to 300% more efficient than electrical heating, so you can further reduce its running cost. Now, meet year-round needs with one air conditioner.

Contents

Safety precautions	3
Checking before use	10
Viewing the parts	13
Cleaning and maintaining the air conditioner.....	14
Appendix	17
Installation parts	20



Correct Disposal of This Product (Waste Electrical & Electronic Equipment)

(Applicable in the countries with separate collection systems)

This marking on the product, accessories or literature indicates that the product and its electronic accessories (e.g. charger, headset, USB cable) should not be disposed of with other household waste at the end of their working life. To prevent possible harm to the environment or human health from uncontrolled waste disposal, please separate these items from other types of waste and recycle them responsibly to promote the sustainable reuse of material resources.

Household users should contact either the retailer where they purchased this product, or their local government office, for details of where and how they can take these items for environmentally safe recycling.

Business users should contact their supplier and check the terms and conditions of the purchase contract. This product and its electronic accessories should not be mixed with other commercial wastes for disposal.







For information on Samsung's environmental commitments and product specific regulatory obligations e.g. REACH visit: samsung.com/uk/aboutsamsung/samsungelectronics/corporatecitizenship/data_corner.html

Safety precautions

Before using your new air conditioner, please read this manual thoroughly to ensure that you know how to safely and efficiently operate the extensive features and functions of your new appliance.

Because the following operating instructions cover various models, the characteristics of your air conditioner may differ slightly from those described in this manual. If you have any questions, call your nearest contact center or find help and information online at www.samsung.com.

Important safety symbols and precautions:

 WARNING	Hazards or unsafe practices that may result in severe personal injury or death .
 CAUTION	Hazards or unsafe practices that may result in minor personal injury or property damage .
	Follow directions.
	Do NOT attempt.
	Make sure the machine is grounded to prevent electric shock.
	Unplug the power plug from the wall socket.
	Do NOT disassemble.

Safety precautions

FOR INSTALLATION

WARNING

- !** Use the power line with the power specifications of the product or higher and use the power line for this appliance only. In addition, do not use an extension line.
 - ▶ Extending the power line may result in electric shock or fire.
 - ▶ Do not use an electric transformer. It may result in electric shock or fire.
 - ▶ If the voltage/frequency/rated current condition is different, it may cause fire.**The installation of this appliance must be performed by a qualified technician or service company.**
 - ▶ Failing to do so may result in electric shock, fire, explosion, problems with the product, or injury.**Install a switch and circuit breaker dedicated to the air conditioner.**
 - ▶ Failing to do so may result in electric shock or fire.**Fix the outdoor unit firmly so that the electric part of the outdoor unit is not exposed.**
 - ▶ Failing to do so may result in electric shock or fire.

FOR INSTALLATION

WARNING

- ⊘** Do not install this appliance near a heater, inflammable material. Do not install this appliance in a humid, oily or dusty location, in a location exposed to direct sunlight and water (rain drops). Do not install this appliance in a location where gas may leak.
 - ▶ This may result in electric shock or fire.**Never install the outdoor unit in a location such as on a high external wall where it could fall.**
 - ▶ If the outdoor unit falls, it may result in injury, death or property damage.
- ⚡** This appliance must be properly grounded. Do not ground the appliance to a gas pipe, plastic water pipe, or telephone line.
 - ▶ Failure to do so may result in electric shock, fire, an explosion, or other problems with the product.
 - ▶ Never plug the power cord into a socket that is not grounded correctly and make sure that it is in accordance with local and national codes.

FOR INSTALLATION **CAUTION**

-  **Install your appliance on a level and hard floor that can support its weight.**
 - ▶ Failing to do so may result in abnormal vibrations, noise, or problems with the product.

Install the draining hose properly so that water is drained correctly.



- ▶ Failing to do so may result in water overflowing and property damage.

When installing the outdoor unit, make sure to connect the draining hose so that draining is performed correctly.

- ▶ The water generated during the heating operation by the outdoor unit may overflow and result in property damage.

In particular, in winter, if a block of ice falls, it may result in injury, death or property damage.

FOR POWER SUPPLY **WARNING**

-  **When the circuit breaker is damaged, contact your nearest service center.**
-  **Do not pull or excessively bend the power line. Do not twist or tie the power line. Do not hook the power line over a metal object, place a heavy object on the power line, insert the power line between objects, or push the power line into the space behind the appliance.**
 - ▶ This may result in electric shock or fire.

FOR POWER SUPPLY **CAUTION**

-  **When not using the air conditioner for a long period of time or during a thunder/lightning storm, cut the power at the circuit breaker.**
 - ▶ Failing to do so may result in electric shock or fire.

Safety precautions

FOR USING

WARNING



If the appliance is flooded, please contact your nearest service center.

- ▶ Failing to do so may result in electric shock or fire.

If the appliance generates a strange noise, a burning smell or smoke, unplug the power plug immediately and contact your nearest service center.

- ▶ Failing to do so may result in electric shock or fire.

In the event of a gas leak (such as propane gas, LP gas, etc.), ventilate immediately without touching the power line.

Do not touch the appliance or power line.

- ▶ Do not use a ventilating fan.
- ▶ A spark may result in an explosion or fire.

To reinstall the air conditioner, please contact your nearest service center.

- ▶ Failing to do so may result in problems with the product, water leakage, electric shock, or fire.
- ▶ A delivery service for the product is not provided. If you reinstall the product in another location, additional construction expenses and an installation fee will be charged.
- ▶ Especially, when you wish to install the product in an unusual location such as in an industrial area or near the seaside where it is exposed to the salt in the air, please contact your nearest service center.

FOR USING

WARNING



Do not touch the circuit breaker with wet hands.

- ▶ This may result in electric shock.

Do not strike or pull the air conditioner with excessive force.

- ▶ This may result in fire, injury, or problems with the product.

Do not place an object near the outdoor unit that allows children to climb onto the machine.

- ▶ This may result in children seriously injuring themselves.

Do not turn the air conditioner off with the circuit breaker while it is operating.

- ▶ Turning the air conditioner off and then on again with the circuit breaker may cause a spark and result in electric shock or fire.

After unpacking the air conditioner, keep all packaging materials well out of the reach of children, as packaging materials can be dangerous to children.

- ▶ If a child places a bag over its head, it may result in suffocation.

Do not insert your fingers or foreign substances into the outlet when the air conditioner is operating or the front panel is closing.

- ▶ Take special care that children do not injure themselves by inserting their fingers into the product.

Do not touch the front panel with your hands or fingers during the heating operation.

- ▶ This may result in electric shock or burns.

Do not insert your fingers or foreign substances into the air inlet/outlet of the air conditioner.

- ▶ Take special care that children do not injure themselves by inserting their fingers into the product.

Do not use this air conditioner for long periods of time in badly ventilated locations or near infirm people.

- ▶ Since this may be dangerous due to a lack of oxygen, open a window at least once an hour.

FOR USING



WARNING



If any foreign substance such as water has entered the appliance, cut the power by unplugging the power plug and turning the circuit breaker off and then contact your nearest service center.

- ▶ Failing to do so may result in electric shock or fire.



Do not attempt to repair, disassemble, or modify the appliance yourself.

- ▶ Do not use any fuse (such as cooper, steel wire, etc.) other than the standard fuse.
- ▶ Failing to do so may result in electric shock, fire, problems with the product, or injury.

Safety precautions

FOR USING

CAUTION

- !** **Do not place objects or devices under the indoor unit.**
 - ▶ Water dripping from the indoor unit may result in fire or property damage.
Check that the installation frame of the outdoor unit is not broken at least once a year.
 - ▶ Failing to do so may result in injury, death or property damage.
Max current is measured according to IEC standard for safety and current is measured according to ISO standard for energy efficiency.

- ⊘** **Do not stand on top of the appliance or place objects (such as laundry, lighted candles, lighted cigarettes, dishes, chemicals, metal objects, etc.) on the appliance.**
 - ▶ This may result in electric shock, fire, problems with the product, or injury.
Do not operate the appliance with wet hands.
 - ▶ This may result in electric shock.
Do not spray volatile material such as insecticide onto the surface of the appliance.
 - ▶ As well as being harmful to humans, it may also result in electric shock, fire or problems with the product.
Do not drink the water from the air conditioner.
 - ▶ The water may be harmful to humans.
Do not apply a strong impact to the remote controller and do not disassemble the remote controller.
 - ▶ **Do not touch the pipes connected with the product.**
 - ▶ This may result in burns or injury.

FOR USING

CAUTION

- ⊘** **Do not use this air conditioner to preserve precision equipment, food, animals, plants or cosmetics, or for any other unusual purposes.**
 - ▶ This may result in property damage.
Avoid directly exposing humans, animals or plants from the air flow from the air conditioner for long periods of time.
 - ▶ This may result in harm to humans, animals or plants.

This appliance is not intended for use by persons (including children) with reduced physical, sensory or mental capabilities, or lack of experience and knowledge, unless they have been given supervision or instruction concerning use of the appliance by a person responsible for their safety. Children should be supervised to ensure that they do not play with the appliance.

For use in Europe : This appliance can be used by children aged from 8 years and above and persons with reduced physical, sensory or mental capabilities or lack of experience and knowledge if they have been given supervision or instruction concerning use of the appliance in a safe way and understand the hazards involved. Children shall not play with the appliance. Cleaning and user maintenance shall not be made by children without supervision.

FOR CLEANING



WARNING

- ⊘ **Do not clean the appliance by spraying water directly onto it. Do not use benzene, thinner or alcohol to clean the appliance.**
 - ▶ This may result in discoloration, deformation, damage, electric shock or fire.
- Before cleaning or performing maintenance, unplug the air conditioner from the wall socket and wait until the fan stops.**
- ▶ Failing to do so may result in electric shock or fire.

FOR CLEANING



CAUTION

- ⓘ **Take care when cleaning the surface of the heat exchanger of the outdoor unit since it has sharp edges.**
 - ▶ To avoid cutting your fingers, wear thick cotton gloves when cleaning it.
- ⊘ **Do not clean the inside of the air conditioner by yourself.**
 - ▶ For cleaning inside the appliance, contact your nearest service center.
 - ▶ When cleaning the internal filter, refer to the descriptions in the 'Cleaning and maintaining the air conditioner' section.
 - ▶ Failure to do so may result in damage, electric shock or fire.

Checking before use

Operation ranges

The table below indicates the temperature and humidity ranges the air conditioner can be operated within.

Refer to the table for efficient use.

MODE	OPERATIONAL TEMPERATURE		INDOOR HUMIDITY	IF OUT OF CONDITIONS
	INDOOR	OUTDOOR		
COOLING	18°C to 32°C	-5°C to 48°C	80% or less	Condensation may occur on the indoor unit with risk to have either water blow off or drops on the floor.
HEATING	27°C or less	-20°C to 24°C	-	Internal protection triggers and the air conditioner will stop.
DRYING	18°C to 32°C	-5°C to 48°C	-	Condensation may occur on the indoor unit with risk to have either water blow off or drops on the floor.



NOTE

- The standardized temperature for heating is 7°C/45°F. If the outdoor temperature drops to 0°C/32°F or below, the heating capacity can be reduced depending on the temperature condition.
If the cooling operation is used at over 32°C/90°F (indoor temperature), it does not cool at its full capacity.



CAUTION

- The use of the air conditioner at a relative humidity above the expected one (80%) may cause the formation of condensate and the leakage of water drops on the floor.

Maintaining your air conditioner

Internal protections via the unit control system

- This internal protection operates if an internal fault occurs in the air conditioner.

Type	Description
Against cold air	The internal fan will be off to against cold air when the heat pump is heating.
De-ice cycle (Defrost cycle)	The internal fan will be off to against cold air when the heat pump is heating.
Protect compressor	The air conditioner does not start operating immediately to protect the compressor of the outdoor unit after it has been started.



NOTE

- If the heat pump is operating in Heat mode, De-ice cycle is actuated to remove frost from an outdoor unit that may have deposited at low temperatures.
The internal fan is switched off automatically and restarted only after the de-ice cycle is completed.

Tips on using air conditioner

Here are some tips that you would follow when using your air conditioner.

TOPIC	RECOMMENDATION
Cooling	<ul style="list-style-type: none">• If current outside temperatures are much higher than the selected indoor temperature, it may take time to bring the inner temperature to the desired coolness.• Avoid drastically turning down the temperature. Energy is wasted and the room does not cool faster.
Heating	<ul style="list-style-type: none">• Since the air conditioner heats the room by taking heat energy from outdoor air, the heating capacity may decrease when outdoor temperatures are extremely low. If you feel the air conditioner insufficiently heats, using an additional heating appliance in combination with the air conditioner is recommended.
Frost & De-ice	<ul style="list-style-type: none">• When the air conditioner runs in Heat mode, due to temperature difference between the unit and the outside air, frost will form. If this happens:<ul style="list-style-type: none">- The air conditioner stops heating.- The air conditioner will operate automatically in De-ice mode for 10 minutes.- The steam produced on the outdoor unit in De-ice mode is safe.No intervention is required; after about 10 minutes, the air conditioner operates again normally. <p>✳The unit will not operate when it starts to de-ice.</p>
Fan	<ul style="list-style-type: none">• Fan may not operate for about 3~5 minutes at the beginning to prevent any cold blasts while the air conditioner is warming up.
High indoor/ outdoor temperatures	<ul style="list-style-type: none">• If both indoor and outdoor temperatures are high and the air conditioner is running in Heat mode, the outdoor unit's fan and compressor may stop at times. This is normal; wait until the air conditioner turns on again.
Power failure	<ul style="list-style-type: none">• If a power failure occurs during the operation of the air conditioner, the operating immediately stops and unit will be off. When power returns, the air conditioner will run automatically.
Protection mechanism	<ul style="list-style-type: none">• If the air conditioner has just been turned on after operation stops or being plugged in, cool/warm air does not come out for 3 minutes to protect the compressor of the outdoor unit.

Checking before use

Selecting the best location

You may set up your air conditioner under the ceiling.

Consider interior design, available space and the origin of cool air to select the best location.

※ This product must be installed on the ceiling. (Do not make it stand up for use.)

Under the ceiling

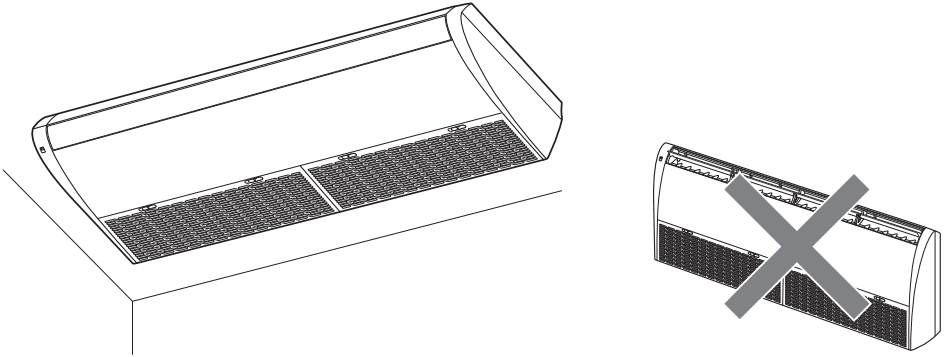

Adjusting the air flow direction

You may set up your air conditioner under the ceiling.

Move the each set of inner air flow blades left or right to keep the air flow direction in a constant position you prefer.

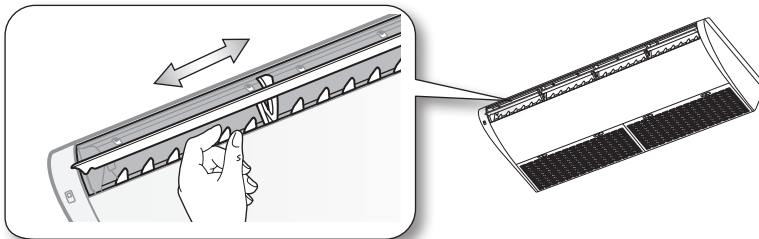

- Be extremely careful with your fingers while adjusting the Horizontal air flow direction. There is a potential risk of personal injury when the unit is mishandled.

Viewing the parts

Congratulations on the purchase of the air conditioner. We hope you enjoy the features of your air conditioner and stay cool with optimal efficiency.

Please read the user manual to get started and to make the best use of the air conditioner.

Main parts

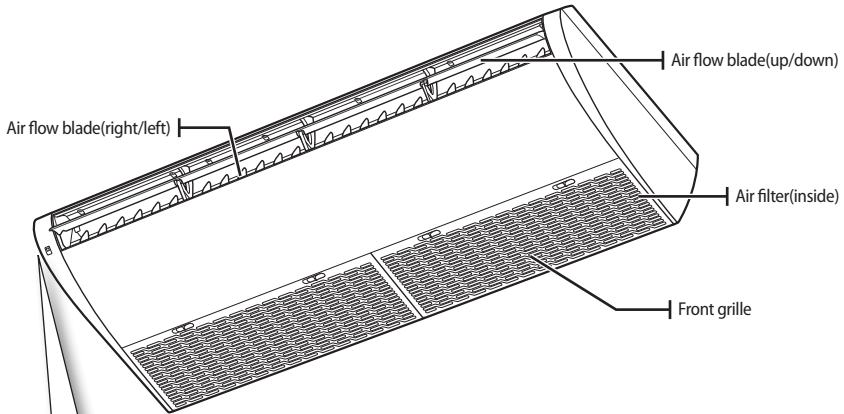

Display

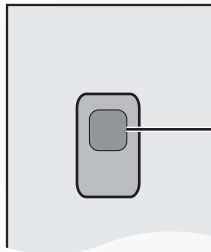

- Blue : Operating indicator
- Orange : Filter indicator
- Green : Schedule indicator
- Red : Error indicator



• Your air conditioner and display may look slightly different from the illustration shown above depending on your model.

Cleaning and maintaining the air conditioner

For the best performance from your air conditioner, clean it periodically. When cleaning, make sure to unplug from the unit for user's safety.

Cleaning the exterior

When cleaning the exterior, make sure to unplug the power from the unit. No special tools are needed to clean it. Wipe the surface of the unit with a slightly wet or dry cloth when needed. Wipe off dirt of odd-shaped area by using a soft brush.



- Do not use Benzene or Thinner (Organic solvent). They may damage the surface of the air conditioner and can create a risk of fire.

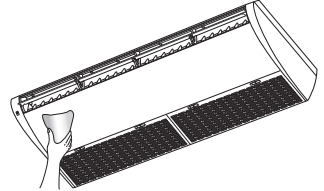

Cleaning the filter

When cleaning the filter, make sure to unplug the power from the unit. Washable foam based Air filter captures large particles from the air. The filter is cleaned with a vacuum or by hand washing.

1. Open the front grille.

Slide the both hooks and unscrew two screws by screw driver from both of front grille.

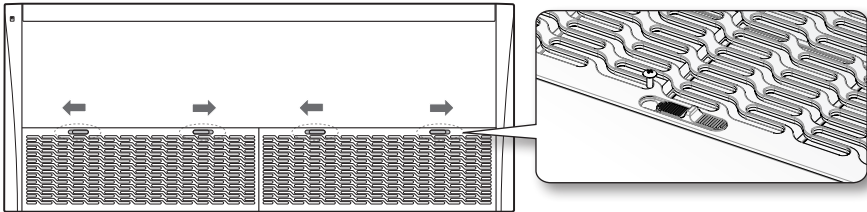

2. Detach the front grille.

Open the grill and push it gently (over 100°) to detach the grille. Then, lift up the front grille.

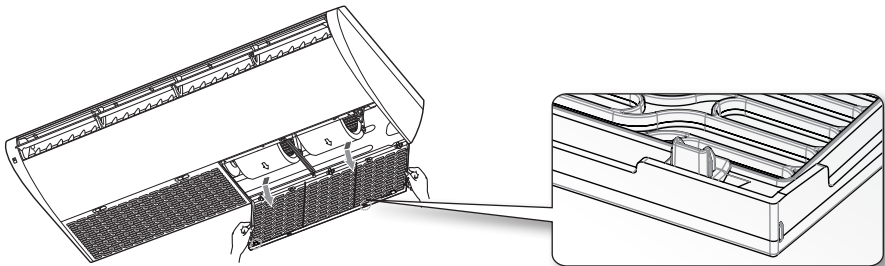

3. Pull out the Air filter.

Slightly press the air filter and then pull the air filter out.

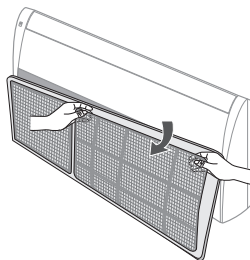

4. Clean the Air filter with a vacuum cleaner or soft brush. If dust is too heavy, then rinse it with running water and dry it in a ventilated area.

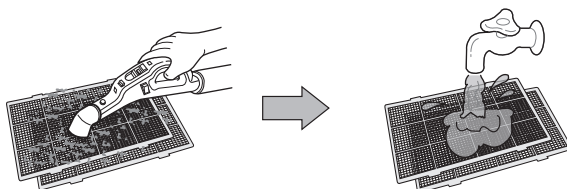

5. Insert the Air filter back in its original position.

6. Close the front grille.



NOTE

- The illustration shown above may differ from yours depending on your model.
- After cleaning the filter, press the **Filter Reset** button on the remote control for 2 seconds to reset the filter schedule. Filter sign indicator will be on for cleaning time.

Cleaning and maintaining the air conditioner

If the air conditioner will not be used for an extended period of time, dry the air conditioner to maintain it in best condition.

- ▶ Dry the air conditioner thoroughly by operating in Fan mode for 3 to 4 hours and disconnect the power plug. There may be internal damage if moisture is left in components.
- ▶ Before using the air conditioner again, dry the inner components of the air conditioner again by running in Fan mode for 3 to 4 hours. This helps remove odors which may have generated from dampness.

Periodical checks

Refer to the following chart to maintain the air conditioner properly.

Type	Description	Monthly	Every 2 months	Every 6 months	Once a year
Indoor unit	Clean the air filter	●			
	Clean the condensate drain pan			●	
	Thoroughly clean the heat exchanger			●	
	Clean the condensate drain pipe		●		
	Replace the remote control batteries				●
Outdoor unit	Clean the heat exchanger on the outside of the unit		●		
	Clean the heat exchanger on the inside of the unit			●	
	Verify that all the electric components are firmly tightened			●	
	Clean the fan			●	
	Verify that all the fan assembly is firmly tightened			●	
	Clean the condensate drain pan			●	

● : This check mark requires checking the indoor/outdoor unit periodically, following to the description to maintain the air conditioner properly.



• The described operations should be performed more frequently if the area of installation is very dusty.



• These operations must always be performed by qualified personnel. For more detailed information, see the installation part in the manual.

Appendix

Troubleshooting

Refer to the following chart if the air conditioner operates abnormally. This may save time and unnecessary expenses.

PROBLEM	SOLUTION
The air conditioner does not operate immediately after it has been restarted.	<ul style="list-style-type: none">• Because of the protective mechanism, the appliance does not start operating immediately to keep the unit from overloading. The air conditioner will start in 3 minutes.
The air conditioner does not work at all.	<ul style="list-style-type: none">• Check that the power plug is properly connected. Insert the power plug into the wall socket correctly.• Check if the circuit breaker is switched off.• Check if there is a power failure.• Check your fuse. Make sure it is not blown out.
The temperature does not change.	<ul style="list-style-type: none">• Check if you selected Fan mode. Press the Mode button on the remote control to select another mode.
The cool (warm) air does not come out of the air conditioner.	<ul style="list-style-type: none">• Check if the set temperature is higher (lower) than the current temperature. Press the Temperature button on the remote control to change the set temperature. Press the Temperature button to decrease or increase the temperature.• Check if the air filter is blocked by dirt. Clean the air filter once a month.• Check if the air conditioner has just been turned on. If so, wait 3 minutes. Cool air does not come out to protect the compressor of the outdoor unit.• Check if the air conditioner is installed in a place with a direct exposure to sunlight. Hang curtains on windows to boost cooling efficiency.• Check if the cover or any obstacle is not near the outdoor unit.• Check if the refrigerant pipe is too long.• Check if the air conditioner is only available in Cool mode.• Check if the remote control is only available for cooling model.

Appendix

PROBLEM	SOLUTION
The fan speed does not change.	<ul style="list-style-type: none">• Check if you selected Auto or Dry mode. The air conditioner automatically adjusts the fan speed to Auto in Auto/Dry mode.
Timer function does not set.	<ul style="list-style-type: none">• Check if you press the Power button on the remote control after you have set the time.
Odors permeate in the room during operation.	<ul style="list-style-type: none">• Check if the appliance is running in a smoky area or if there is a smell entering from outside. Operate the air conditioner in Fan mode or open the windows to air out the room.
The air conditioner makes a bubbling sound.	<ul style="list-style-type: none">• A bubbling sound may be heard when the refrigerant is circulating through the compressor. Let the air conditioner operate in a selected mode.• When you press the Power button on the remote control, noise may be heard from the drain pump inside the air conditioner.
Water is dripping from the air flow blades.	<ul style="list-style-type: none">• Check if the air conditioner has been cooling for an extended period of time with the air flow blades pointed downwards. Condensation may generate due to the difference in temperature.
Remote control is not working.	<ul style="list-style-type: none">• Check if your batteries are depleted.• Make sure batteries are correctly installed.• Make sure nothing is blocking your remote control sensor.• Check that there are strong lighting apparatus near the air conditioner. Strong light which comes from fluorescent bulbs or neon signs may interrupt the electric waves.
The air conditioner does not turn on or off with the wired remote control.	<ul style="list-style-type: none">• Check if you set the wired remote control for group control.
The wired remote control does not operate.	<ul style="list-style-type: none">• Check if TEST indicator is displayed on the wired remote control. If so, turn off the unit and switch off the circuit breaker. Call your nearest contact center.
The indicators of the digital display flashes.	<ul style="list-style-type: none">• Press the Power button on the remote control to turn the unit off and switch the circuit breaker off. Then, switch it on again.

Model specification (Dimension and weight)

Dimension and weight			
Type	Model	Net dimension (WxDxH) (mm)	Net weight(kg)
Indoor Unit	AM112JNCDKH	1350 x 235 x 675	33.5
	AM140JNCDKH	1650 x 235 x 675	42.5

Ceiling installation

1 Select pipe directions.

When the directions are selected, drill 3-1/8"-(100mm, for pipe and cables) and 1-3/4"-(40mm, for drain hose) diameter holes on the wall so that it slants slightly downwards toward the outdoor for smooth water flow.

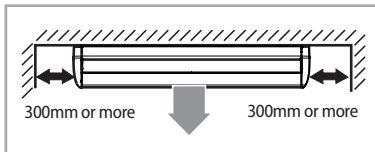

Use the template to select pipe directions.

2 Drill holes for anchor bolts according to the distance and mount them.

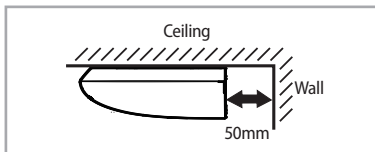

Use the template.

3 Install the unit onto the ceiling. Be sure to arrange the drain hose so that it is leveled lower than the drain hose connecting port of the indoor unit.

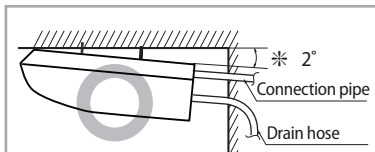

For proper drainage of condensate, give a 2° (The gap between the lower end of the indoor unit and the ceiling should be 23 mm or more.) slant to the side of the unit which will be connected with the drain hose as shown in the figure.

* 2° (The gap between the lower end of the indoor unit and the ceiling should be 23 mm or more.)



- Ensure that the ceiling is strong enough to support the weight of the indoor unit.
- Before hanging the unit, test the strength of each attached suspension bolt.
- Install the drain hose from the rear of the unit.

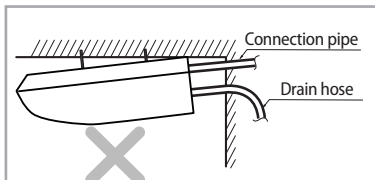

Give a 1° slant to the right side of the unit.

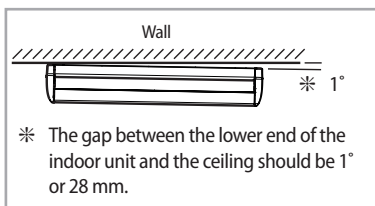

* The gap between the lower end of the indoor unit and the ceiling should be 1° or 28 mm.

Performing leak test & insulation

Leak test

LEAK TEST WITH NITROGEN (before opening valves)

In order to detect basic refrigerant leaks, before recreating the vacuum and recirculating the R-410A, it's responsible of installer to pressurize the whole system with nitrogen (using a cylinder with pressure reducer) at a pressure above 40 bar (gauge).

LEAK TEST WITH R-410A (after opening valves)

Before opening valves, discharge all the nitrogen into the system and create vacuum. After opening valves check leaks using a leak detector for refrigerant R410A.

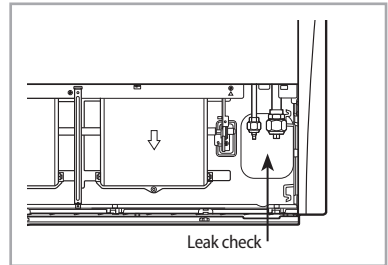

※ The designs and shape are subject to change according to the model.

Insulation

Once you have checked that there are no leaks in the system, you can insulate the piping and hose.

- 1 To avoid condensation problems, place Acrylonitrile Butadien Rubber separately around each refrigerant pipe.



Always make the seam of pipes face upwards.

- 2 Wind insulating tape around the pipes and drain hose avoiding to compress the insulation too much.

- 3 Finish wrapping insulating tape around the rest of the pipes leading to the outdoor unit.

- 4 The pipes and electrical cables connecting the indoor unit with the outdoor unit must be fixed to the wall with suitable ducts.

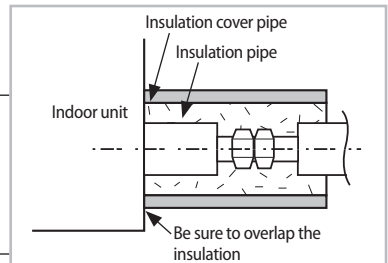
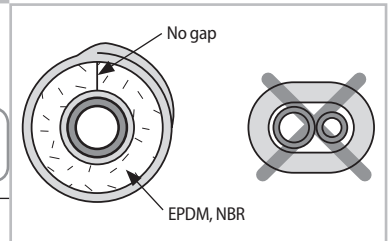

Must fit tightly against body without any gap.



All refrigerant connection must be accessible, in order to permit either unit maintenance or removing it completely.

Performing leak test & insulation

5 Select the insulation of the refrigerant pipe.

- ▶ Insulate the gas side and liquid side pipe referring to the thickness according to the pipe size.
- ▶ Indoor temperature of 30 °C and humidity of 85 % is the standard condition.

If installing in a high humidity condition, use one grade thicker insulator by referring to the table below.

If installing in an unfavorable conditions, use thicker one.

- ▶ Insulator's heat-resistance temperature should be more than 120 °C.

Pipe	Pipe size	Insulation Type (Heating/Cooling)		Remarks
		Standard [30 °C, 85 %]	High humidity [30 °C, over 85 %]	
EPDM, NBR				
Liquid pipe	Ø 6.35 ~ Ø 9.52	9 t	9 t	Internal temperature is higher than 120 °C
	Ø 12.7 ~ Ø 19.05	13 t	13 t	
Gas pipe	Ø 6.35	13 t	19 t	
	Ø 9.52	19 t	25 t	
	Ø 12.70			
	Ø 15.88			
	Ø 19.05			

- ▶ When installing insulation in places and conditions below, use the same insulation that is used for high humidity conditions.

<Geological condition>

- High humidity places such as shoreline, hot spring, near lake or river, and ridge (when the part of the building is covered by earth and sand.)

<Operation purpose condition>

- Restaurant ceiling, sauna, swimming pool etc.

<Building construction condition>

- The ceiling frequently exposed to moisture and cooling is not covered.
- e.g. The pipe installed at a corridor of a dormitory and studio or near an exit that opens and closes frequently.
- The place where the pipe is installed is highly humid due to the lack of ventilation system.



- Install the insulation not to get wider and use the adhesives on the connection part of it to prevent moisture from entering.
- Wind the refrigerant pipe with insulation tape if it is exposed to outside sunlight.
- Install the refrigerant pipe respecting that the insulation does not get thinner on the bent part or hanger of pipe.
- Add the additional insulation if the insulation plate gets thinner.

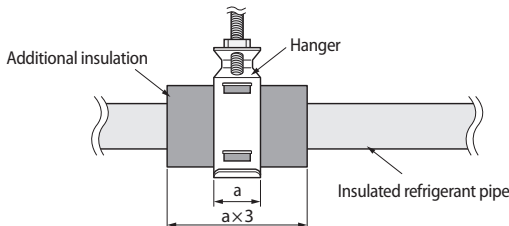

Drain hose installation

Care must be taken when installing the drain hose from the indoor unit to ensure that any condensate water is correctly drained outside.

The drain hose can be installed to the right of the base pan.

- 1 Installing the drain hose should be the shorter, the better.
 - ▶ In order to discharge condensate water, a downward gradient should be maintained.
 - ▶ Fix the drain hose with Cable-Tie, so that it will not separate from the machine.

- 2 Insulate and fix the drain hose according to the figure.
 - ▶ Insert the drain hose to bottom of the outfall of water basin.
 - ▶ Lock flexible hose clamp of the drain hose according to the figure.
 - ▶ Wind and wrap flexible hose clamp and drain hose fully with thermal insulation sponge; fix both ends of external layer with ribbon for thermal insulation.
 - ▶ After being installed, drain hose must be insulated fully by heat insulating material. (To be provided at site.)

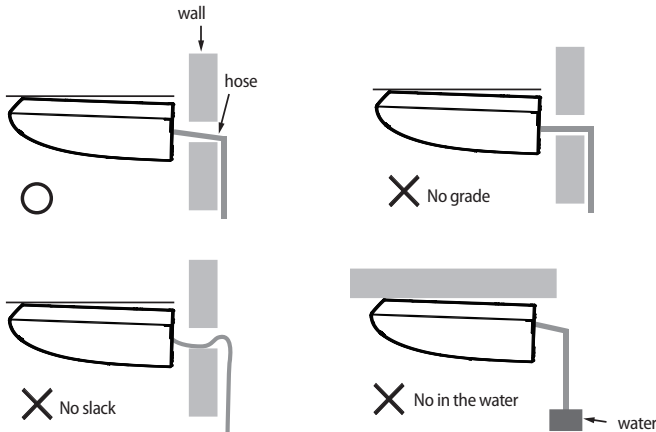
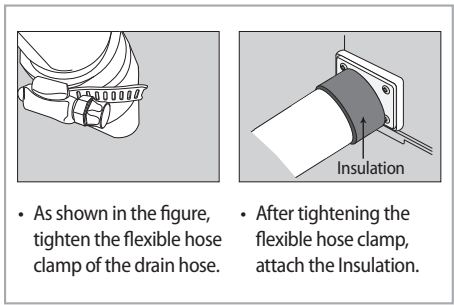
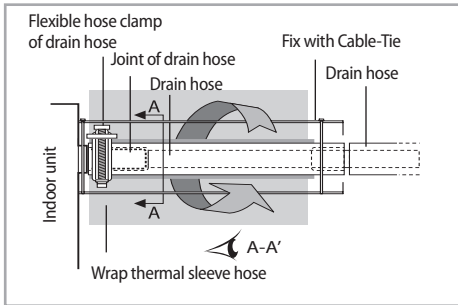

Wiring work

Power and communication cable connection

1. Before wiring work, you must turn off all power source.
2. Indoor unit power should be supplied through the breaker(ELCB or MCCB+ELB) separated by the outdoor power.
ELCB : Earth Leakage Circuit Breaker
MCCB : Molded Case Circuit Breaker
ELB : Earth Leakage Breaker
3. The power cable should be used only copper wires.
4. Connect the power cable{1(L), 2(N)} among the units within maximum length and communication cable(F1, F2) each.
5. Connect F3, F4(for communication) when installing the wired remote control.

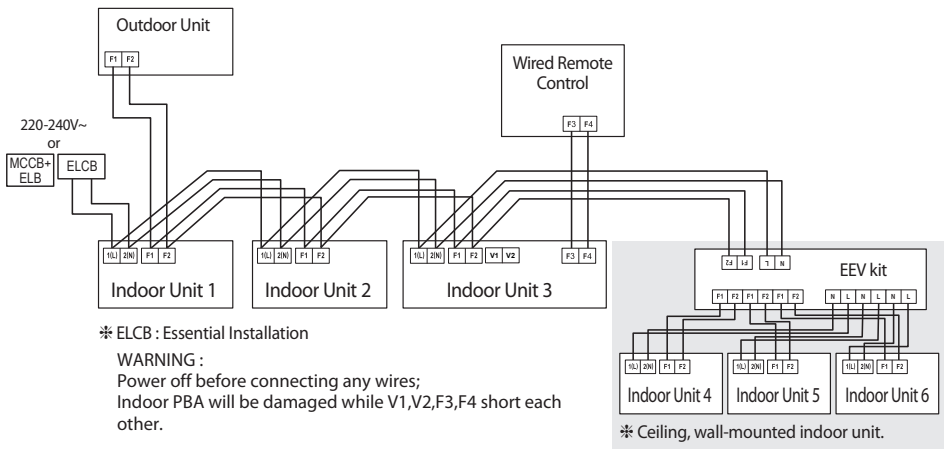

Selecting compressed ring terminal

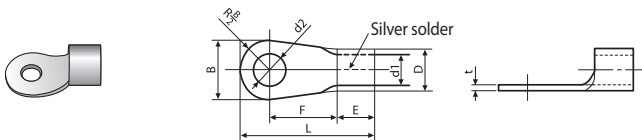

Nominal dimensions for cable (mm ²)	Nominal dimensions for screw (mm)	B		D		d1		E	F	L	d2		t
		Standard dimension (mm)	Allowance (mm)	Standard dimension (mm)	Allowance (mm)	Standard dimension (mm)	Allowance (mm)				Standard dimension (mm)	Allowance (mm)	
1.5	4	6.6	±0.2	3.4	+0.3 -0.2	1.7	±0.2	4.1	6	16	4.3	+0.2 0	0.7
	8												
2.5	4	6.6	±0.2	4.2	+0.3 -0.2	2.3	±0.2	6	6	17.5	4.3	+0.2 0	0.8
	8.5												
4	4	9.5	±0.2	5.6	+0.3 -0.2	3.4	±0.2	6	5	20	4.3	+0.2 0	0.9

Specification of electronic wire

Power supply	MCCB	ELB or ELCB	Power cable	Earth cable	Communication cable
Max : 242V Min : 198V	X A	X A, 30mmA 0.1 s	2.5mm ²	2.5mm ²	0.75~1.5mm ²

- ◆ Decide the capacity of ELCB(or MCCB+ELB) by below formula.
- ◆ Power supply cords of parts of appliances for outdoor use shall not be lighter than polychloroprene sheathed flexible cord.
(Code designation IEC:60245 IEC 57 / CENELEC: H05RN-F or IEC:60245 IEC 66 / CENELEC: H07RN-F)

$$\text{The capacity of ELCB(or MCCB+ELB) } X [A] = 1.25 \times 1.1 \times \sum A_i$$

- * X : The capacity of ELCB(or MCCB+ELB).
- * $\sum A_i$: Sum of Rating currents of each indoor unit.
- * Refer to each installation manual about the rating current of indoor unit.

- ◆ Decide the power cable specification and maximum length within 10% power drop among indoor units.

$$\sum_{k=1}^n \left(\frac{\text{Coef} \times 35.6 \times L_k \times i_k}{1000 \times A_k} \right) < 10\% \text{ of input voltage [V]}$$

- * coef: 1.55
- * Lk: Distance among each indoor unit[m], Ak: Power cable specification[mm²]
- ik: Running current of each unit[A]



- ! In case of extending the electric wire, please DO NOT use a round-shaped pressing socket.
- Incomplete wire connections can cause electric shock or a fire.

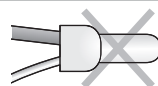

Setting an indoor unit address and installation option

Set the indoor unit address and installation option with remote controller option.

Set the each option separately since you cannot set the ADDRESS setting and indoor unit installation setting option at the same time. You need to set twice when setting indoor unit address and installation option.

The procedure of option setting

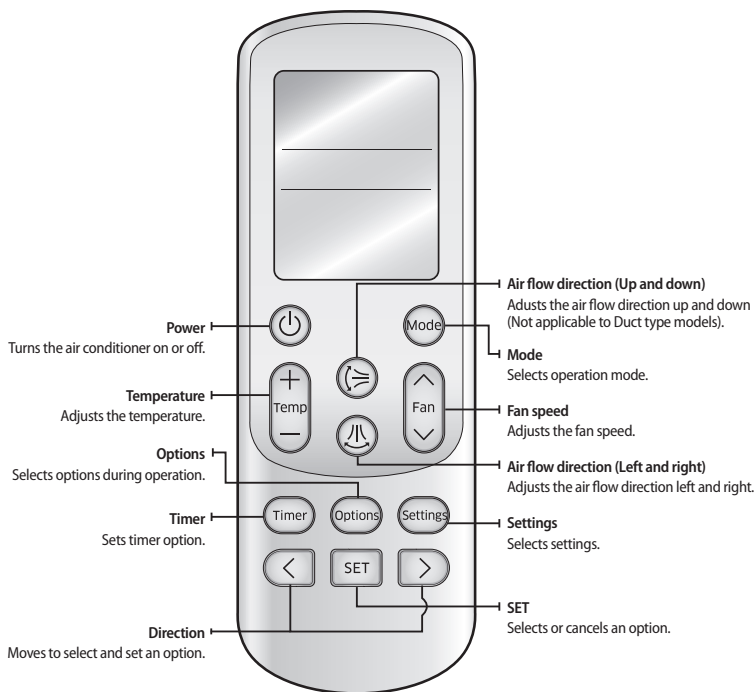

Step 1. Entering mode to set option

1. Remove batteries from the remote controller.
2. Insert batteries and enter the option setting mode while pressing High Temp button and Low Temp button.

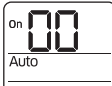
3.  Check if you have entered the option setting status.

Step 2. The procedure of option setting









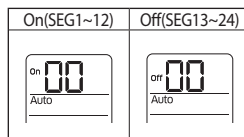

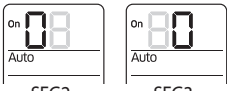
After entering the option setting status, select the option as listed below.

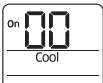
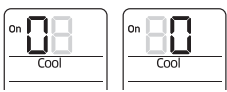

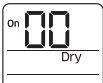
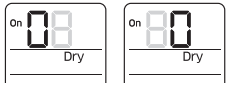

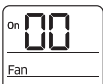
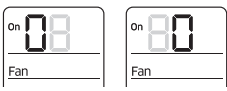

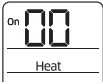
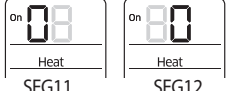

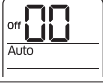
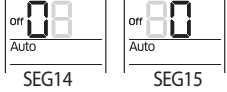



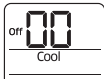



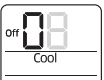
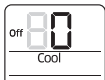

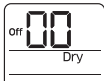



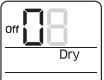
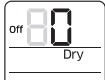

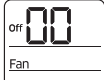
- Option setting is available from SEG1 to SEG 24
- SEG1, SEG7, SEG13, SEG19 are not set as page option.
- Set the SEG2~SEG6, SEG8~SEG12 as ON status and SEG14~18, SEG20~24 as OFF status.

SEG1	SEG2	SEG3	SEG4	SEG5	SEG6	SEG7	SEG8	SEG9	SEG10	SEG11	SEG12
0	X	X	X	X	X	1	X	X	X	X	X
SEG13	SEG14	SEG15	SEG16	SEG17	SEG18	SEG19	SEG20	SEG21	SEG22	SEG23	SEG24
2	X	X	X	X	X	3	X	X	X	X	X

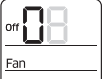
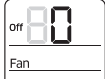

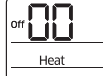
Option setting	Status
<p>1. Setting SEG2, SEG3 option</p> <p>Press Low Fan button(∨) to enter SEG2 value.</p> <p>Press High Fan button(∧) to enter SEG3 value.</p> <p>Each time you press the button, 0 → 1 → ... → E → F will be selected in rotation.</p>	 <p>SEG2 SEG3</p>
<p>2. Setting Cool mode</p> <p> Press Mode button to be changed to Cool mode in the ON status.</p>	
<p>3. Setting SEG4, SEG5 option</p> <p>Press Low Fan button(∨) to enter SEG4 value.</p> <p>Press High Fan button(∧) to enter SEG5 value.</p> <p>Each time you press the button, 0 → 1 → ... → E → F will be selected in rotation.</p>	 <p>SEG4 SEG5</p>
<p>4. Setting Dry mode</p> <p> Press Mode button to be changed to DRY mode in the ON status.</p>	
<p>5. Setting SEG6, SEG8 option</p> <p>Press Low Fan button(∨) to enter SEG6 value.</p> <p>Press High Fan button(∧) to enter SEG8 value.</p> <p>Each time you press the button, 0 → 1 → ... → E → F will be selected in rotation.</p>	 <p>SEG6 SEG8</p>
<p>6. Setting Fan mode</p> <p> Press Mode button to be changed to FAN mode in the ON status.</p>	
<p>7. Setting SEG9, SEG10 option</p> <p>Press Low Fan button(∨) to enter SEG9 value.</p> <p>Press High Fan button(∧) to enter SEG10 value.</p> <p>Each time you press the button, 0 → 1 → ... → E → F will be selected in rotation.</p>	 <p>SEG9 SEG10</p>
<p>8. Setting Heat mode</p> <p> Press Mode button to be changed to HEAT mode in the ON status.</p>	
<p>9. Setting SEG11, SEG12 option</p> <p>Press Low Fan button(∨) to enter SEG11 value.</p> <p>Press High Fan button(∧) to enter SEG12 value.</p> <p>Each time you press the button, 0 → 1 → ... → E → F will be selected in rotation.</p>	 <p>SEG11 SEG12</p>
<p>10. Setting Auto mode</p> <p> Press Mode button to be changed to AUTO mode in the OFF status.</p>	
<p>11. Setting SEG14, SEG15 option</p> <p>Press Low Fan button(∨) to enter SEG14 value.</p> <p>Press High Fan button(∧) to enter SEG15 value.</p> <p>Each time you press the button, 0 → 1 → ... → E → F will be selected in rotation.</p>	 <p>SEG14 SEG15</p>

Setting an indoor unit address and installation option

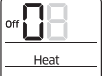
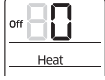
Option setting	Status
<p>12. Setting Cool mode</p> <p> Press Mode button to be change to Cool mode in the OFF status.</p>	
<p>13. Setting SEG16, SEG17 option</p> <p>Press Low Fan button(∨) to enter SEG16 value. Press High Fan button(∧) to enter SEG17 value. Each time you press the button,  →  → ...  →  will be selected in rotation.</p>	  <p style="text-align: center;">SEG16 SEG17</p>
<p>14. Setting Dry mode</p> <p> Press Mode button to be change to Dry mode in the OFF status.</p>	
<p>15. Setting SEG18, SEG20 option</p> <p>Press Low Fan button(∨) to enter SEG18 value. Press High Fan button(∧) to enter SEG20 value. Each time you press the button,  →  → ...  →  will be selected in rotation.</p>	  <p style="text-align: center;">SEG18 SEG20</p>
<p>16. Setting Fan mode</p> <p> Press Mode button to be change to Fan mode in the OFF status.</p>	
<p>17. Setting SEG21, SEG22 option</p> <p>Press Low Fan button(∨) to enter SEG21 value. Press High Fan button(∧) to enter SEG22 value. Each time you press the button,  →  → ...  →  will be selected in rotation.</p>	  <p style="text-align: center;">SEG21 SEG22</p>
<p>18. Setting Heat mode</p> <p> Press Mode button to be change to HEAT mode in the OFF status.</p>	
<p>19. Setting SEG23, SEG24 mode</p> <p>Press Low Fan button(∨) to enter SEG23 value. Press High Fan button(∧) to enter SEG24 value. Each time you press the button,  →  → ...  →  will be selected in rotation.</p>	  <p style="text-align: center;">SEG23 SEG24</p>

Step 3. Check the option you have set

After setting option, press  button to check whether the option code you input is correct or not.

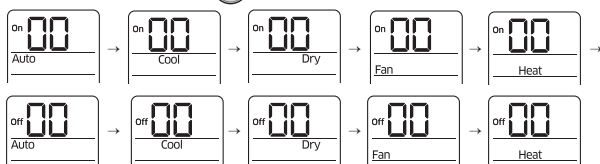

Step 4. Input option

Press operation button  with the direction of remote control for set.
For the correct option setting, you must input the option twice.

Step 5. Check operation

1. Reset the indoor unit by pressing the RESET button of indoor unit or outdoor unit.
2. Take the batteries out of the remote controller and insert them again and then press the operation button.

Setting an indoor unit address (MAIN/RMC)

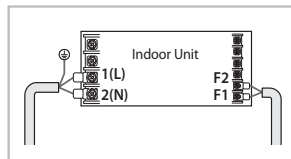

1. Check whether power is supplied or not.
 - When the indoor unit is not plugged in, there should be additional power supply in the indoor unit.
2. The panel(display) should be connected to an indoor unit to receive option.
3. Before installing the indoor unit, assign an address to the indoor unit according to the air conditioning system plan.
4. Assign an indoor unit address by wireless remote controller.
 - The initial setting status of indoor unit ADDRESS(MAIN/RMC) is "0A0000-100000-200000-300000".

Option No. : 0AXXXX-1XXXXX-2XXXXX-3XXXXX

Option	SEG1		SEG2		SEG3		SEG4		SEG5		SEG6	
Explanation	PAGE		Mode		Setting Main address		100-digit of indoor unit address		10-digit of indoor unit		The unit digit of an indoor unit	
Remote Controller Display												
Indication and Details	Indication	Details	Indication	Details	Indication	Details	Indication	Details	Indication	Details	Indication	Details
	0		A		0	No Main address	0~9	100-digit	0~9	10-digit	0~9	A unit digit
				1	Main address setting mode							
Option	SEG7		SEG8		SEG9		SEG10		SEG11		SEG12	
Explanation	PAGE				Setting RMC address				Group channel(*16)		Group address	
Remote Controller Display												
Indication and Details	Indication	Details	—		Indication	Details	—		Indication	Details	Indication	Details
	1				0	No RMC address			RMC1	0~F	RMC2	0~F
					1	RMC address setting mode						



- When "A"~"F" is entered to SEG5~6, the indoor unit MAIN ADDRESS is not changed.
- If you set the SEG 3 as 0, the indoor unit will maintain the previous MAIN ADDRESS even if you input the option value of SEG5~6.
- If you set the SEG 9 as 0, the indoor unit will maintain previous RMC ADDRESS even if you input the option value of SEG11~12.
- You cannot set SEG11 and SEG12 as F value at the same time.

Setting an indoor unit address and installation option

Setting an indoor unit installation option (suitable for the condition of each installation location)

- Check whether power is supplied or not.
 - When the indoor unit is not plugged in, there should be additional power supply in the indoor unit.
- The panel(display) should be connected to an indoor unit to receive option.
- Set the installation option according to the installation condition of an air conditioner.
 - The default setting of an indoor unit installation option is "020010-100000- 200000-300000".
 - Individual control of a remote controller(SEG20) is the function that controls an indoor unit individually when there is more than one indoor unit.
- Set the indoor unit option by wireless remote controller.

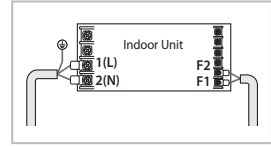

02 series installation option

SEG1	SEG2	SEG3	SEG4	SEG5	SEG6
0	2	--	External room temperature sensor / Minimizing fan operation when thermostat is off	Central control	FAN RPM compensation
SEG7	SEG8	SEG9	SEG10	SEG11	SEG12
1	Drain pump	Hot water heater	--	EEV Step when heating stops	--
SEG13	SEG14	SEG15	SEG16	SEG17	SEG18
2	External control	External control output / External heater On or Off signal	S-Plasma ion	Buzzer	Number of hours using filter
SEG19	SEG20	SEG21	SEG22	SEG23	SEG24
3	Individual control of a remote controller	Heating setting compensation / Removing condensated water in heating mode	EEV Step of stopped unit during oil return/ defrost mode	Motion detect sensor	--

- ◆ 1WAY/2WAY/4WAY MODEL : Drain pump(SEG8) will be set to 'USE + 3minute delay' even if the drain pump is set to 0.
- ◆ 1 WAY/2WAY/4WAY,DUCT MODEL : Number of hours using filter(SEG18) will be set to '1000hour' even if the SEG18 is set to except for 2 or 6.
- ◆ When setting the option other than above SEG values, the option will be set as "0".
- ◆ SEG5 central control option is basically set as 1 (Use), so you don't need to set the central control option additionally.
However, if the central control is not connected but it doesn't indicate an error message, you need to set the central control option as 0 (Disuse) to exclude the indoor unit from the central control.

- ◆ The output of hot water heater in SEG9 is generated from the hot coil part of the terminal board in duct models.

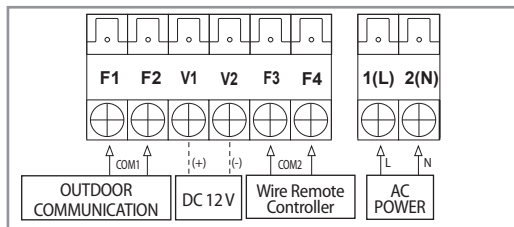

* The output of hot coil terminal is AC 220V / 230 V
(The same as Indoor Unit's input Power)

- ◆ The external output of SEG15 is generated by MIM-B14 connection. (Refer to the manual of MIM-B14.)

■ 02 series installation option(Detailed)

Option No. : 02XXXX-1XXXX-2XXXX-3XXXX

Option	SEG1	SEG2	SEG3	SEG4	SEG5	SEG6							
Explanation	PAGE	MODE	Use of robot cleaning	Use of external room temperature sensor / Minimizing fan operation when thermostat is off	Use of central control	FAN RPM compensation							
Remote Controller Display													
Indication and Details	Indication	Details	Indication	Details	Indication	Details	Indication	Details	Indication	Details	Indication	Details	
	0		2	0	Disuse	0	Disuse	0	Disuse	0	Disuse	0	Disuse
				1	Use	1	Use	1	Use	1	Use	1	RPM compensation
				2	Disuse	2	Disuse	2	Use (*)	2	Use (*)	2	High ceiling KIT
				3	Use	3	Use	3	Use (*)	3	Use (*)	3	Use (*)
Option	SEG7	SEG8	SEG9	SEG10	SEG11	SEG12							
Explanation	PAGE	Use of drain pump	Use of hot water heater		EEV Step when heating stops								
Remote Controller Display													
Indication and Details	Indication	Details	Indication	Details	Indication	Details	Indication	Details	Indication	Details	Indication	Details	
	1		0	Disuse	0	Disuse	0	Default value	0	Default value	0	Default value	
			1	Use	1	Use (*)	1	Noise decreasing setting	1	Noise decreasing setting	1	Noise decreasing setting	
			2	When an indoor unit stops, drain pump will operate for 3min	2	--	2		2		2		
			3		3	Use (*)	3		3		3		

Setting an indoor unit address and installation option

Option	SEG13	SEG14		SEG15			SEG16		SEG17		SEG18			
Explanation	PAGE	Use of external control		Setting the output of external control / External heater On/Off signal			S-Plasma ion		Buzzer control		Hours of filter usage			
Remote Controller Display														
Indication and Details	Indication	Details	Indication	Details	Indication	Details		Indication	Details	Indication	Details	Indication	Details	
						Setting the output of external control	External heater On/Off signal							
	2	0	Disuse	0	Thermo on	-	0	Disuse	0	Use buzzer	2	1000 Hour		
		1	ON/OFF control	1	Operation on	-	1	Use	1	Disuse buzzer	6	2000 Hour		
		2	OFF control	2	-	Use ^(*)								
3	Window ON/OFF control	3	-	Use ^(*)										
Option	SEG19	SEG20		SEG21			SEG22		SEG23		SEG24			
Explanation	PAGE	Individual control of a remote controller		Heating setting compensation / Removing condensated water in heating mode			EEV Step of stopped unit during oil return/ defrost mode		Motion detect sensor		-			
Remote Controller Display														
Indication and Details	Indication	Details	Indication	Details	Indication	Details		Indication	Details	Indication	Details			
						Heating Setting Compensation	Removing Condensated Water in Heating Mode							
	3	0 or 1	channel 1	0	Default ^(*)	Disuse	0	Default value	0	Disuse	1	Turn out in 30min. without motion		
			channel 2	1	2°C	Disuse			1	Oil return or Noise decreasing in defrost mode	2	Turn out in 60min. without motion		
			channel 3	2	5°C	Disuse					3	Turn out in 120min. without motion		
		4	channel 4	3	Default ^(*)	Use ^(*)	1	Oil return or Noise decreasing in defrost mode	4	Turn out in 180min. without motion				
				4	2°C	Use ^(*)			5	Turn out in 30min. without motion or *advanced function				
				5	5°C	Use ^(*)			6	Turn out in 60min. without motion or *advanced function				
										7	Turn out in 120min. without motion or *advanced function			
										8	Turn out in 180min. without motion or *advanced function			

* Advanced function: Controlling cooling/heating current or power saving with motion detect.

(*1) Minimizing fan operation when thermostat is off

- Fan operates for 20 seconds at an interval of 5 minutes in heat mode.

(*2) 1: Fan is turned on continually when the hot water heater is turned on,

3: Fan is turned off when the hot water heater is turned on with cooling only indoor unit

Cooling only indoor unit: To use this option, install the Mode Select switch(MCM-C200) on the outdoor unit and fix it as cool mode.

(*3) When the following 2 or 3 is used as external heater On/Off signal, the signal for monitoring external contact control will not be output.

2: Fan is turned on continually when the external heater is turned on,

3: Fan is turned off when the external heater is turned on with cooling only indoor unit

Cooling only indoor unit: To use this option, install the Mode Select switch(MCM-C200) on the outdoor unit and fix it as cool mode.

- If Fan is set to off for cooling only indoor unit by setting the SEG9=3 or SEG15=3, you need to use an external sensor or wired remote controller sensor to detect indoor temperature exactly.

(*4) Default setting value

- 4Way Cassette, Mini 4Way Cassette: 5 °C

- Other indoor units: 2 °C

(*5) This function can be applied to 4 Way Cassette and Mini 4 Way Cassette only. If the air conditioner operates the heating mode

immediately after finishing the cooling mode, the condensed water in the drain pan becomes water vapor by the heat of the indoor

unit heat exchanger. Since the water vapor might be condensed on the indoor unit, which may fall into a living space, use this function to

get rid of the water vapor out of the indoor unit by operating the fan (for maximum 20 minutes) even when the indoor unit is turned off

after cooling mode is turned to heating mode.

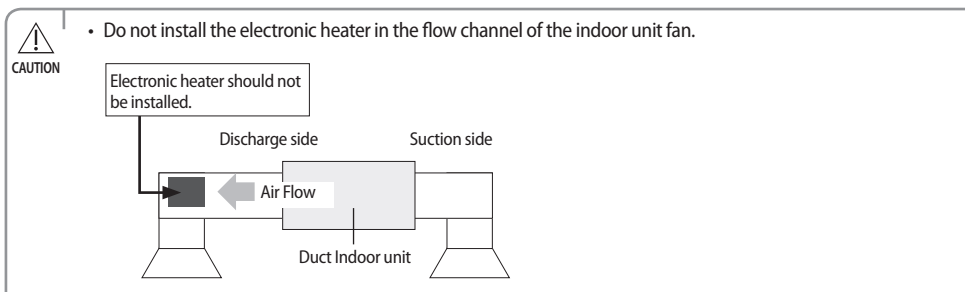









■ 05 series installation option

SEG1	SEG2	SEG3	SEG4	SEG5	SEG6
0	5	Use of Auto Change Over for HR only in Auto mode	(When setting SEG3) Standard heating temp. Offset	(When setting SEG3) Standard cooling temp. Offset	(When setting SEG3) Standard for mode change Heating → Cooling
SEG7	SEG8	SEG9	SEG10	SEG11	SEG12
1	(When setting SEG3) Standard for mode change Cooling → Heating	(When setting SEG3) Time required for mode change	Compensation option for Long pipe or height difference between indoor units	-	-
SEG13	SEG14	SEG15	SEG16	SEG17	SEG18
2	-	-	-	-	Control variables when using hot water / external heater
SEG19	SEG20	SEG21	SEG22	SEG23	SEG24
3	-	-	-	-	-

Setting an indoor unit address and installation option

■ 05 series installation option(Detailed)

Option No. : 05XXXX-1XXXXX-2XXXXX-3XXXXX

Option	SEG1		SEG2		SEG3		SEG4		SEG5		SEG6		
Explanation	PAGE		MODE		Use of Auto Change Over for HR only in Auto mode		(When setting SEG3) Standard heating temp. Offset		(When setting SEG3) Standard cooling temp. Offset		(When setting SEG3) Standard for mode change Heating – Cooling		
Remote Controller Display													
Indication and Details	Indication	Details	Indication	Details	Indication	Details	Indication	Details	Indication	Details	Indication	Details	
	0		5		0	Follow product option	0	0°C	0	0°C	0	1°C	
					1	Use Auto Change Over for HR only	1	0.5°C	1	0.5°C	1	1.5°C	
							2	1°C	2	1°C	2	2°C	
							3	1.5°C	3	1.5°C	3	2.5°C	
							4	2°C	4	2°C	4	3°C	
							5	2.5°C	5	2.5°C	5	3.5°C	
							6	3°C	6	3°C	6	4°C	
7							3.5°C	7	3.5°C	7	4.5°C		
Option	SEG7		SEG8		SEG9		SEG10		SEG11		SEG12		
Explanation	PAGE		(When setting SEG3) Standard for mode changing Cooling → Heating mode		(When setting SEG3) Time required for mode change		Compensation option for Long pipe or height difference between indoor units						
Remote Controller Display													
Indication and Details	Indication	Details	Indication	Details	Indication	Details	Indication	Details					
	1		0	1°C	0	5 min.	0	Use default value	1	1)Height difference ¹⁾ is more than 30m or 2)Distance ²⁾ is longer than 110m			
			1	1.5°C	1	7 min.							
			2	2°C	2	9 min.							
			3	2.5°C	3	11 min.	2	1)Height difference ¹⁾ is 15~30m or 2)Distance ²⁾ is 50~110m					
			4	3°C	4	13 min.							
			5	3.5°C	5	15 min.							
			6	4°C	6	20 min.							
7			4.5°C	7	30 min.								

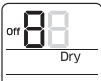
Option	SEG13	SEG14	SEG15	SEG16	SEG17	SEG18 ^{(*)3}					
Explanation						Control variables when using hot water / external heater					
Remote Controller Display											
Indication and Details	2							Indication	Details		
									Set temp. for heater On/Off		Delay time for heater On
									0	At the same time as thermo on	No delay
									1	At the same time as thermo on	10 minutes
									2	At the same time as thermo on	20 minutes
									3	1.5 °C	No delay
									4	1.5 °C	10 minutes
									5	1.5 °C	20 minutes
									6	3.0 °C	No delay
									7	3.0 °C	10 minutes
									8	3.0 °C	20 minutes
									9	4.5 °C	No delay
									A	4.5 °C	10 minutes
									B	4.5 °C	20 minutes
									C	6.0 °C	No delay
D	6.0 °C	10 minutes									
E	6.0 °C	20 minutes									

(*1) Height difference : The difference of the height between the corresponding indoor unit and the indoor unit installed at the lowest place.
 For example, When the indoor unit is installed 40m higher than the indoor unit installed at the lowest place, select the option "1".

(*2) Distance: The difference between the pipe length of the indoor unit installed at farthest place from an outdoor unit and the pipe length of the corresponding indoor unit from an outdoor unit.
 For example, when the farthest pipe length is 100 m(328 ft) and the corresponding indoor unit is 40 m away from an outdoor unit, select the option "2".
 (100 - 40 = 60m)

(*3) Heater operation when the SEG9 of 02 series installation option is set to using hot water heater or when SEG15 is set to using external heater

- e.g. 1) Setting 02 series SEG9 = "1" / Setting 05 series SEG18 = "0": Hot water heater is turned on at the same time as the heating thermostat is on, and turned off when the heating thermostat is off.
- e.g. 2) Setting 02 series SEG15 = "2" / Setting 05 series SEG18 = "A":
 Room temp. ≤ set temp. + f(heating compensation temp.)
 - External heater is turned on when the temperature is maintained as 4.5 °C for 10 minutes.
 Room temp. > set temp. + f(heating compensation temp.)
 - External heater is turned off when the temperature is maintained as 4.5 °C + 1 °C (1 °C is the Hysteresis for On/Off selection.)

Setting an indoor unit address and installation option

SEG 3, 4, 5, 6, 8, 9 additional information



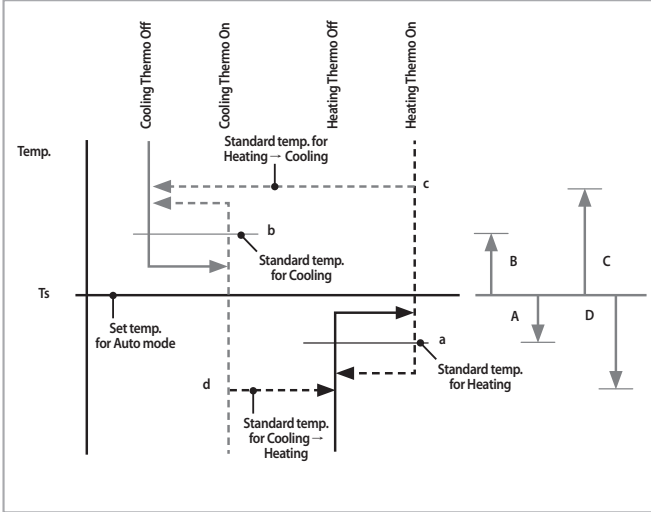

When the SEG 3 is set as "1" and follow Auto Change Over for HR only operation, it will operate as follows.



Cooling/Heating mode can be changed when Thermo Off status is maintained during the time with SEG9.

Changing a particular option

You can change each digit of set option.

Option	SEG1		SEG2		SEG3		SEG4		SEG5		SEG6	
Explanation	PAGE		MODE		The option mode you want to change		The tens' digit of an option SEG you will change		The unit digit of an option SEG you will change		Changed value	
Remote Controller Display												
Indication and Details	Indication	Details	Indication	Details	Indication	Details	Indication	Details	Indication	Details	Indication	Details
	0		D		Option mode	1~6	Tens' digit of SEG	0~9	Unit digit of SEG	0~9	The changed value	0~F



NOTE

- When changing a digit of an indoor unit address setting option, set the SEG3 as 'A'.
- When changing a digit of indoor unit installation option, set the SEG3 as '2'.

Ex) When setting the 'buzzer control' into disuse status.

Option	SEG1	SEG2	SEG3	SEG4	SEG5	SEG6
Explanation	PAGE	MODE	The option mode you want to change	The tens' digit of an option SEG you will change	The unit digit of an option SEG you will change	Changed value
Indication	0	D	2	1	7	1



CAUTION

- If you are using heat pump model, mixed operation mode (two or more indoor units operating in different operation mode simultaneously) is not available when the indoor units are connected to same outdoor unit. If you set the master indoor unit with a remote controller, outdoor unit will operate in the mode which was set in the master indoor unit.

QUESTIONS OR COMMENTS?

COUNTRY	CALL	OR VISIT US ONLINE AT	COUNTRY	CALL	OR VISIT US ONLINE AT
AUSTRIA	0800-SAMSUNG (0800-7267864) [Only for Premium HA] 0800-366661 [Only for Dealers] 0810-112233	www.samsung.com/at/support	UKRAINE	0-800-502-000	www.samsung.com/ua/support (Ukrainian) www.samsung.com/ua_ru/support (Russian)
BELGIUM	02-201-24-18	www.samsung.com/be/support (Dutch) www.samsung.com/be_fr/support (French)	MOLDOVA	0-800-614-40	www.samsung.com/support
BOSNIA	055 233 999	www.samsung.com/support	U.A.E	800-SAMSUNG (800 - 726 7864)	
BULGARIA	*3000 Цена в мрежката 0800 111 31 , Безплатна телефонна линия	www.samsung.com/bg/support	OMAN	800-SAMSUNG (800 - 726 7864)	
CROATIA	072 726 786	www.samsung.com/hr/support	KUWAIT	183-CALL (183-2255)	www.samsung.com/ae/support (English) www.samsung.com/ae_ar/support (Arabic)
CZECH	800 - SAMSUNG (800-726786)	www.samsung.com/cz/support	BAHRAIN	8000-GSAM (8000-4726)	
DENMARK	70 70 19 70	www.samsung.com/dk/support	QATAR	800-CALL (800-2255)	
FINLAND	030-6227 515	www.samsung.com/fi/support	EGYPT	08000-726786 16580	www.samsung.com/eg/support
FRANCE	01 48 63 00 00	www.samsung.com/fr/support	ALGERIA	3004	www.samsung.com/n_alfica/support
GERMANY	0180 6 SAMSUNG bzw. 0180 6 7267864* *(0,20 €/Anruf aus dem dt. Festnetz, aus dem Mobilfunk max. 0,60 €/Anruf) [HHP] 0180 6 M SAMSUNG bzw. 0180 6 67267864* *(0,20 €/Anruf aus dem dt. Festnetz, aus dem Mobilfunk max. 0,60 €/Anruf)	www.samsung.com/de/support	PAKISTAN	0800-Samsung (72678)	www.samsung.com/pk/support
CYPRUS	8009 4000 only from landline, toll free		TUNISIA	80 1000 12	www.samsung.com/n_alfica/support
GREECE	80111-SAMSUNG (80111 726 7864) only from land line (+30) 210 6897691 from mobile and land line	www.samsung.com/gr/support	JORDAN	0800-22273 06 5777444	www.samsung.com/levant
HUNGARY	0680SAMSUNG (0680-726-786) 0680PREMIUM (0680-773-648)	www.samsung.com/hu/support	SYRIA	962 5777444	
ITALIA	800-SAMSUNG (800.7267864)	www.samsung.com/it/support	IRAN	021-8255 [CE] 021-42132 [HHP]	www.samsung.com/iran/support
LUXEMBURG	261 03 710	www.samsung.com/be_fr/support	MOROCCO	080 100 22 55	www.samsung.com/n_alfica/support
MONTENEGRO	020 405 888	www.samsung.com/support	SAUDI ARABIA	800 247 3457 (800 24/7 HELP)	www.samsung.com/sa/home www.samsung.com/sa_en
SLOVENIA	0800 697 267 (brezplačna številka)	www.samsung.com/si	TURKEY	444 77 11	www.samsung.com/tr/support
NETHERLANDS	0900-SAMSUNG (0900-7267864) (€ 0,10/Min)	www.samsung.com/nl/support	ARGENTINE	0800-555-SAMSUNG(7267)	www.samsung.com/ar
NORWAY	815 56480	www.samsung.com/no/support	URUGUAY	0800-SAMS(7267)	www.samsung.com/uy
POLAND	801-172-678* lub +48 22 607-93-33* Dedykowana infolinia do obsługi zapytań dotyczących telefonów komórkowych: 801-672-678* lub +48 22 607-93-33* * (koszt połączenia według taryfy operatora)	www.samsung.com/pl/support	PARAGUAY	0800-11-SAMS(7267)	www.samsung.com/py
PORTUGAL	808 20 7267	www.samsung.com/pt/support	BRAZIL	0800-124-421 (Demais cidades e regiões) 4004-0000 (Capitais e grandes centros)	www.samsung.com/br/support
ROMANIA	*8000 (apel in retea) 08008-726-78-64 (08008-SAMSUNG) Apel GRATUIT	www.samsung.com/ro/support	CHILE	800-SAMSUNG(726-7864) [HHP] 02-24828200	www.samsung.com/cl/support
SERBIA	011 321 6899	www.samsung.com/rs/support	BOLIVIA	800-10-7260	www.samsung.com/cl/support
SLOVAKIA	0800 - SAMSUNG(800-726 786)	www.samsung.com/sk/support	COLOMBIA	Bogotá en el 600 12 72 Sin costo en todo el país 01 8000 112 112 Y desde tu celular *726	www.samsung.com/co/support
SPAIN	0034902172678 [HHP] 0034902167267	www.samsung.com/es/support	COSTA RICA	00-800-1-SAMSUNG (726-7864)	
SWEDEN	0771 726 7864 (0771-SAMSUNG)	www.samsung.com/se/support	DOMINICAN REPUBLIC	1-800-751-2676	
SWITZERLAND	0800 726 78 64 (0800-SAMSUNG)	www.samsung.com/ch/support (German) www.samsung.com/ch_fr/support (French)	ECUADOR	1-800-SAMSUNG (72-6786)	www.samsung.com/latin/support (Spanish) www.samsung.com/latin_en/support (English)
UK	0330 SAMSUNG (7267864)	www.samsung.com/uk/support	EL SALVADOR	8000-SAMSUNG (726-7864)	
EIRE	0818 717100	www.samsung.com/ie/support	GUATEMALA	1-800-299-0033	
LITHUANIA	8-800-7777	www.samsung.com/lt/support	HONDURAS	800-2791-9111	
LATVIA	8000-7267	www.samsung.com/lv/support	JAMAICA	1-800-SAMSUNG (726-7864)	www.samsung.com/latin_en/support (English)
ESTONIA	800-7267	www.samsung.com/ee/support	NICARAGUA	001-800-5077267	
RUSSIA	8-800-555-55-55 (VIP care 8-800-555-55-88)	www.samsung.com/ru/support	PANAMA	800-0101	www.samsung.com/latin/support (Spanish) www.samsung.com/latin_en/support (English)
GEORGIA	0-800-555-555	www.samsung.com/support	PUERTO RICO	1-800-682-3180	
ARMENIA	0-800-05-555	www.samsung.com/support	TRINIDAD & TOBAGO	1-800-SAMSUNG(726-7864)	
AZERBAIJAN	0-88-555-55-55	www.samsung.com/support	PERU	08007708 Desde teléfonos fijos ó públicos 7116800 Desde teléfonos celulares	www.samsung.com/pe/support
KAZAKHSTAN	8-10-800-500-55-500 (GSM: 7799, VIP care 7700)	www.samsung.com/kz_ru/support	VENEZUELA	0-800-SAMSUNG (726-7864)	www.samsung.com/latin/support (Spanish) www.samsung.com/latin_en/support (English)
UZBEKISTAN	00-800-500-55-500 (GSM: 7799)	www.samsung.com/support	AUSTRALIA	1300 362 603	www.samsung.com/au/support
KYRGYZSTAN	00-800-500-55-500 (GSM: 9977)	www.samsung.com/support		1-800-10-726-7864 [PLDT Toll Free] 1-800-8-726-7864 [Globe Landline and Mobile] 02-422-2111 [Standard Landline]	PHILIPPINES
TAJIKISTAN	8-10-800-500-55-500	www.samsung.com/support		1-800-10-726-7864 [PLDT Toll Free] 1-800-8-726-7864 [Globe Landline and Mobile] 02-422-2111 [Standard Landline]	PHILIPPINES
MONGOLIA	+7-495-363-17-00	www.samsung.com/support		1800-SAMSUNG(726-7864)	SINGAPORE
BELARUS	810-800-500-55-500	www.samsung.com/support		1-800-10-726-7864 [PLDT Toll Free] 1-800-8-726-7864 [Globe Landline and Mobile] 02-422-2111 [Standard Landline]	PHILIPPINES
				1800-SAMSUNG(726-7864)	SINGAPORE

SAMSUNG ELECTRONICS CO., LTD.

No.501 Suhong East Road,Suzhou Industrial Park,Jiangsu Province,P.R.China

Samsung Electronics (UK) Ltd, Euro QA Lab.

Blackbushe Business Park, Saxony Way, Yateley, Hampshire. GU46 6GG United Kingdom



Ceiling Type Series
AM***JNCDKH

Air Conditioner user manual

imagine the possibilities

Thank you for purchasing this Samsung product.



EN ES FR IT PT DE EL NL PL HU RU DB68-05054A-02

SAMSUNG