

Air conditioner

Installation manual

AC***MNJDKH

- Thank you for purchasing this Samsung air conditioner.
- Before operating this unit, please read this manual carefully and retain it for future reference.



SAMSUNG

Contents

Safety Information	3
---------------------------	----------

Installation Procedure	5
-------------------------------	----------

- Step 1 Checking and preparing accessories
- Step 2 Choosing the installation location
- Step 3 Installing refnet joint
- Step 4 Purging inert gas from the indoor unit
- Step 5 Connecting the assembly pipes to the refrigerant pipes
- Step 6 Cutting and flaring the pipes
- Step 7 Performing the gas leak test
- Step 8 Insulating the refrigerant pipes
- Step 9 Installing the drain hose and drain pipe
- Step 10 Optional: Installing DPM
- Step 11 Connecting the power and communication cables
- Step 12 Optional: Extending the power cable
- Step 13 Setting the indoor unit addresses and the installation options

Appendix	26
-----------------	-----------

Troubleshooting

Safety Information

WARNING

- Hazards or unsafe practices that may result in severe personal injury or death.

CAUTION

- Hazards or unsafe practices that may result in minor personal injury or property damage.
- Carefully follow the precautions listed below because they are essential to guarantee the safety of the equipment.

WARNING

- Always disconnect the air conditioner from the power supply before servicing it or accessing its internal components.
- Verify that installation and testing operations are performed by qualified personnel.
- Verify that the air conditioner is not installed in an easily accessible area.

General information

WARNING

- Carefully read the content of this manual before installing the air conditioner and store the manual in a safe place in order to be able to use it as reference after installation.
- For maximum safety, installers should always carefully read the following warnings.
- Store the operation and installation manual in a safe location and remember to hand it over to the new owner if the air conditioner is sold or transferred.
- This manual explains how to install an indoor unit with a split system with two SAMSUNG units. The use of other types of units with different control systems may damage the units and invalidate the warranty. The manufacturer shall not be responsible for damages arising from the use of non compliant units.

- The manufacturer shall not be responsible for damage originating from unauthorized changes or the improper connection of electric and requirements set forth in the "Operating limits" table, included in the manual, shall immediately invalidate the warranty.
- The air conditioner should be used only for the applications for which it has been designed: the indoor unit is not suitable to be installed in areas used for laundry.
- Do not use the units if damaged. If problems occur, switch the unit off and disconnect it from the power supply.
- In order to prevent electric shocks, fires or injuries, always stop the unit, disable the protection switch and contact SAMSUNG's technical support if the unit produces smoke, if the power cable is hot or damaged or if the unit is very noisy.
- Always remember to inspect the unit, electric connections, refrigerant tubes and protections regularly. These operations should be performed by qualified personnel only.
- The unit contains moving parts, which should always be kept out of the reach of children.
- Do not attempt to repair, move, alter or reinstall the unit. If performed by unauthorized personnel, these operations may cause electric shocks or fires.
- Do not place containers with liquids or other objects on the unit.
- All the materials used for the manufacture and packaging of the air conditioner are recyclable.
- The packing material and exhaust batteries of the remote controller(optional) must be disposed of in accordance with current laws.
- The air conditioner contains a refrigerant that has to be disposed of as special waste. At the end of its life cycle, the air conditioner must be disposed of in authorised centres or returned to the retailer so that it can be disposed of correctly and safely.

Safety Information

Installing the unit

WARNING

IMPORTANT: When installing the unit, always remember to connect first the refrigerant tubes, then the electrical lines.

- Always disassemble the electric lines before the refrigerant tubes.
- Upon receipt, inspect the product to verify that it has not been damaged during transport. If the product appears damaged, DO NOT INSTALL it and immediately report the damage to the carrier or retailer (if the installer or the authorized technician has collected the material from the retailer.)
- After completing the installation, always carry out a functional test and provide the instructions on how to operate the air conditioner to the user.
- Do not use the air conditioner in environments with hazardous substances or close to equipment that release free flames to avoid the occurrence of fires, explosions or injuries.
- Our units should be installed in compliance with the spaces shown in the installation manual, to ensure accessibility from both sides and allow repairs or maintenance operations to be carried out. The unit's components should be accessible and easy to disassemble without endangering people and objects. For this reason, when provisions of the installation manual are not complied with, the cost required to access and repair the units (in SAFETY CONDITIONS, as set out in prevailing regulations) with harnesses, ladders, scaffolding or any other elevation system will NOT be considered part of the warranty and will be charged to the end customer.

Power supply line, fuse or circuit breaker

WARNING

- Always make sure that the power supply is compliant with current safety standards. Always install the air conditioner in compliance with current local safety standards.
- Always verify that a suitable grounding connection is available.
- Verify that the voltage and frequency of the power supply comply with the specifications and that the installed power is sufficient to ensure the operation of any other domestic appliance connected to the same electric lines.
- Always verify that the cut-off and protection switches are suitably dimensioned.
- Verify that the air conditioner is connected to the power supply in accordance with the instructions provided in the wiring diagram included in the manual.
- Always verify that electric connections (cable entry, section of leads, protections...) are compliant with the electric specifications and with the instructions provided in the wiring scheme. Always verify that all connections comply with the standards applicable to the installation of air conditioners.
- Devices disconnected from the power supply should be completely disconnected in the condition of overvoltage category.
- Be sure not to perform power cable modification, midway wiring, and multiple wire connection.
 - It may cause electric shock or fire due to poor connection or insulation and current limit override.
 - When midway wiring is required due to power line damage, refer to "Step 11 Optional: Extending the power cable" in the installation manual.

CAUTION

Make sure that you earth the cables.

- Do not connect the earth wire to the gas pipe, water pipe, lighting rod or telephone wire. If earthing is not complete, electric shock or fire may occur.

Install the circuit breaker.

- If the circuit breaker is not installed, electric shock or fire may occur.

Make sure that the condensed water dripping from the drain hose runs out properly and safely.

Install the power cable and communication cable of the indoor and outdoor unit at least 1m away from the electric appliance.

Install the indoor unit away from lighting apparatus using the ballast.

- If you use the wireless remote control, reception error may occur due to the ballast of the lighting apparatus.





Do not install the air conditioner in following places.



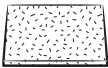

- Place where there is mineral oil or arsenic acid. Resin parts flame and the accessories may drop or water may leak. The capacity of the heat exchanger may reduce or the air conditioner may be out of order.
- The place where corrosive gas such as sulphuric acid gas generates from the vent pipe or air outlet.
- The copper pipe or connection pipe may corrode and refrigerant may leak.
- The place where there is a machine that generates electromagnetic waves. The air conditioner may not operate normally due to control system.
- The place where there is a danger of existing combustible gas, carbon fibre or flammable dust.
- The place where thinner or gasoline is handled. Gas may leak and it may cause fire.

Installation Procedure

Step 1 Checking and preparing accessories

The following accessories are supplied with the indoor unit. The type and quantity may differ, depending on the specifications.

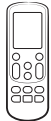
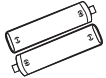
User's manual(1)	Installation manual (1)
	
Insulation Install Outlet (1)	Insulation Install SVC (1)
	

Bracket Hanger (1)	Cable-tie (8)
	
Wireless remote control (1)	Battery (2)
	
Drain Hose (1)	M4x12 tapped screw(2)
	

Installation Procedure

Step 2 Choosing the installation location

General requirements for installation location

Do not install the air conditioner in a location where it will come into contact with the following elements:

- Combustible gases
- Saline air
- Machine oil
- Sulphide gas
- Special environmental conditions

Avoid installing the air conditioner in a location with the following conditions:

- In areas where it is exposed to direct sunlight. Close to heat sources.
- In damp areas or locations where it could come into contact with water. (for example rooms used for laundry)
- In areas where curtains and furniture could affect the supply and discharge of air.
- Without leaving the required minimum space around the unit. (as shown in the drawing)
- In scarcely ventilated areas.
- On surfaces that are unable to support the weight of the unit without deforming, breaking or causing vibrations during the use of the air conditioner.
- In a position that does not enable the condensate drainage pipe to be correctly installed. (at the end of the installation. It is always essential to check the efficiency of the drainage system)

Indoor unit installation requirement

- This unit has to be installed as floor type only.
- There must be no obstacles near the air inlet and outlet.
- Select a convenient location that permits the air to reach every corner of the area to be cooled.
- Pre-plan for easy and short routing of the refrigerant tubing and wiring to the outdoor unit.
- There should be no flammable gas, alkaline, substances present in the air.
- Maintain sufficient clearance around the indoor unit.
- Make sure that the water dripping from the drain hose runs away correctly and safely.
- Do not install the unit where it will be exposed to direct sunlight.

CAUTION

- Our units should be installed in compliance with the spaces shown in the installation manual, to ensure accessibility from both sides and allow repairs or maintenance operations to be carried out. The unit's components should be accessible and easy to disassemble without endangering people and objects.
- For this reason, when provisions of the installation manual are not complied with, the cost required to access and repair the units (in SAFETY CONDITIONS, as set out in prevailing regulations) with harnesses, ladders, scaffolding or any other elevation system will NOT be considered part of the warranty and will be charged to the end customer.

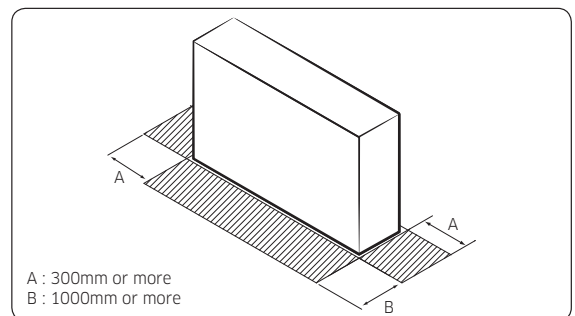

Indoor unit dimensions

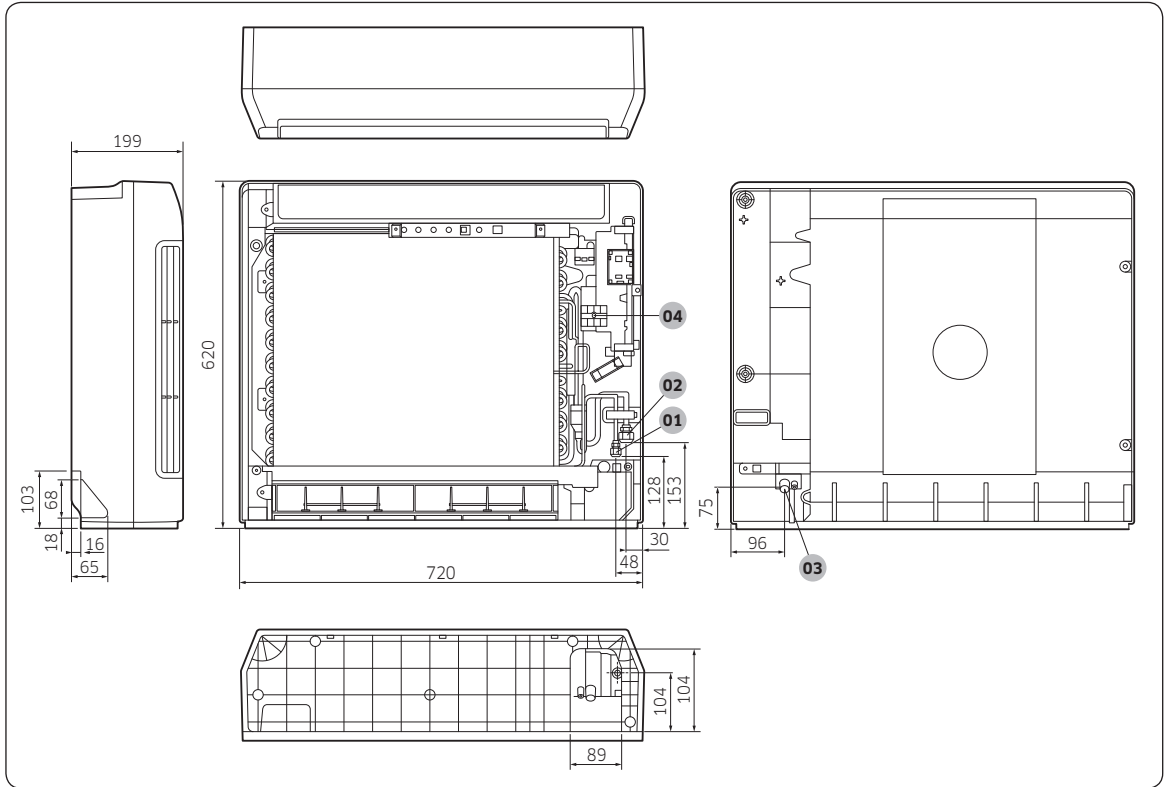

No.	Name	MODEL	
		026 / *035*	*052*
01	Liquid pipe connection	Ø6.35(1/4")	Ø6.35(1/4")
02	Gas pipe connection	Ø9.52(3/8")	Ø12.70(1/2")
03	Drainpipe connection	ID : Ø12 ; OD : Ø18	
04	Power supply connection	0.75~1.5mm ² , 3wires	

Installation Procedure

Step 3 Installing refnet joint

1 When you install the indoor with side-pipe connection, please make space more than 300mm from the wall.

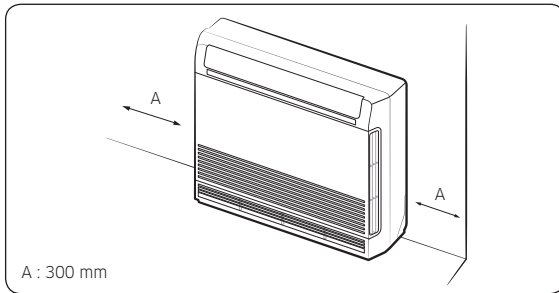

2 When you install the indoor with side-pipe connection, please make space more than 300mm from the wall.

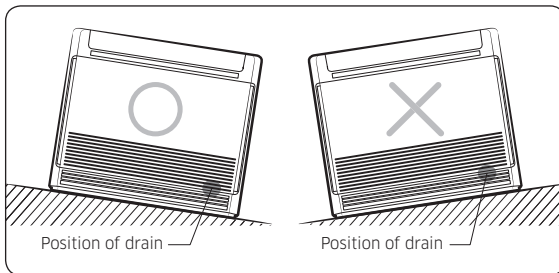

3 Please remove the items when set is installed.
(*026/035*: 6 Items / *052*: 7 Items)

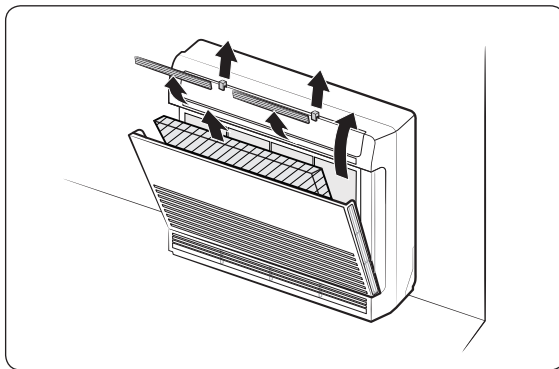

4 The body front should be opened to connect pipes. Please release the 4 screws of body front and then pull it out from the bottom of the set.

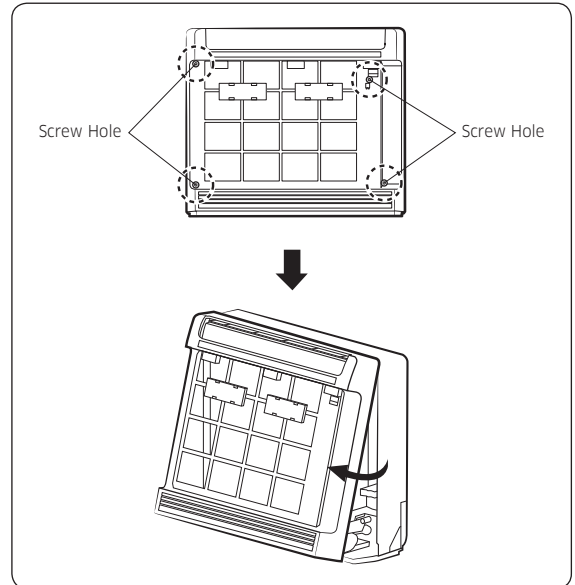

5 Make a hole on the wall.

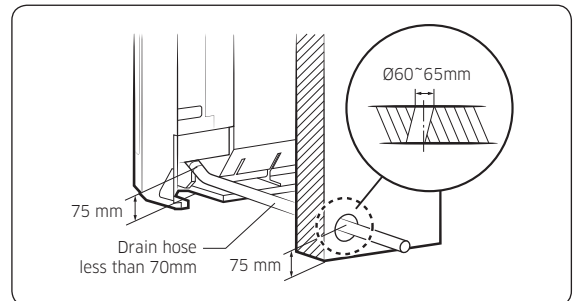

6 The pipes & cable should be gone through the bottom back hole.

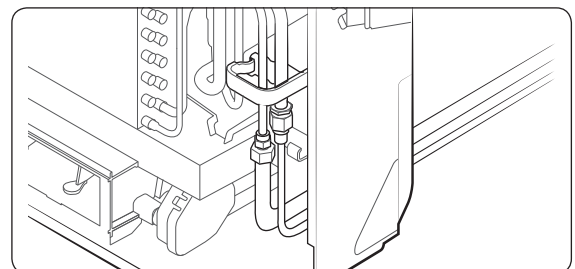

7 Hanging the indoor unit on the Bracket Hanger, then fix the Indoor Unit by using 4 Screws.

- Case 1. Installing on the floor : Must fix 4 screws on the wall, make the indoor not to fall down(For safety installation) .
- Case 2. Hanging on the wall : Follow the installation guide supplied in the accessory part.
 - Screw positions are specified on the installation guide.

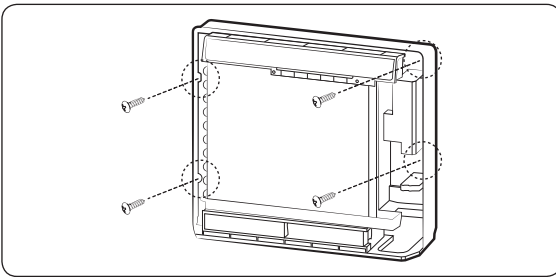

Step 4 Purging inert gas from the indoor unit

From factory the unit is supplied and set with a pre-charge of nitrogen gas (inert gas). Therefore, all inert gas must be purged before connecting the assembly piping. Unscrew the pinch pipe at the end of each refrigerant pipe.

- Result: All inert gas escapes from the indoor unit.

NOTE

To prevent dirt or foreign objects from getting into the pipes during installation, do NOT remove the pinch pipe completely until you are ready to connect the piping.

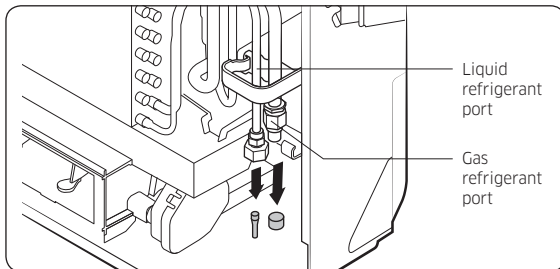

The designs and shape are subject to change according to the model.

Step 5 Connecting the assembly pipes to the refrigerant pipes

There are two refrigerant pipes of different diameters :

- A smaller one for the liquid refrigerant.
- A larger one for the gas refrigerant. The inside of copper pipe must be clean and has no dust.

1 Remove the pinch pipe on the pipes and connect the assembly pipes to each pipe, tightening the nuts, first manually and then with a torque wrench, a spanner applying the following torque.

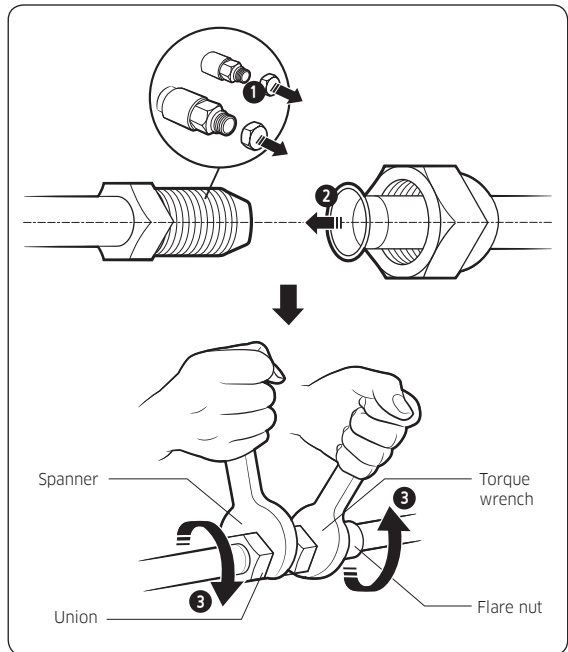

Outer Diameter (mm)	Torque (N•m)
Ø6.35	14 to 18
Ø9.52	34 to 42
Ø12.70	49 to 61
Ø15.88	68 to 82
Ø19.05	100 to 120

(1 N•m=10 kgf•cm)

NOTE

- If the pipes must be shortened, see **Step 6 Cutting and flaring the pipes** on page 10.

Installation Procedure

- 2 Be sure to use an insulator thick enough to cover the refrigerant tube to protect the condensate water on the outside of the pipe falling onto the floor and to improve the efficiency of the unit.
- 3 Cut off any excess foam insulation.
- 4 Make sure that there are no cracks or waves on the bent area.
- 5 It would be necessary to double the insulation thickness (10 mm or more) to prevent condensation even on the insulator when if the installed area is warm and humid.
- 6 Do not use joints or extensions for the pipes that connect the indoor and outdoor unit. The only permitted connections are those for which the units are designed.

⚠ CAUTION

- Connect the indoor and outdoor units using pipes with flared connections (not supplied). For the lines, use insulated, unwelded, degreased and deoxidized copper pipe (Cu DHP type to ISO 1337 or UNI EN 12735-1), suitable for operating pressures of at least 4200kPa and for a burst pressure of at least 20700kPa. Copper pipe for hydro-sanitary applications is completely unsuitable.
- For sizing and limits (height difference, line length, max. bends, refrigerant charge, etc.) see the outdoor unit installation manual.
- All refrigerant connection must be accessible, in order to permit either unit maintenance or removing it completely.

Step 6 Cutting and flaring the pipes

- 1 Make sure that you have the required tools available. (pipe cutter, reamer, flaring tool and pipe holder)
- 2 If you wish to shorten the pipes, cut it with a pipe cutter, taking care to ensure that the cut edge remains at a 90° angle with the side of the pipe. Refer to the illustrations below for examples of edges cut correctly and incorrectly.

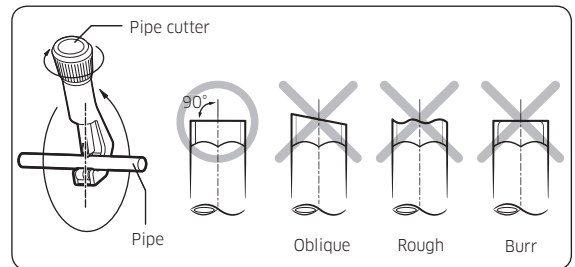

- 3 To prevent any gas from leaking out, remove all burrs at the cut edge of the pipe, using a reamer.
- 4 Slide a flare nut on to the pipe and modify the flare.

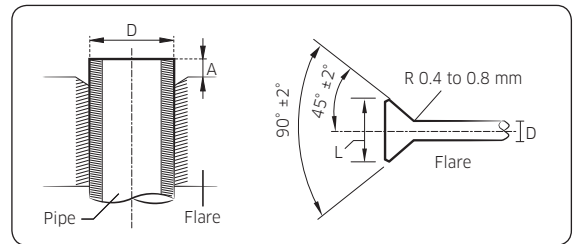

Outer Diameter (D, mm)	Depth (A, mm)	Flare dimension (L, mm)
Ø6.35	1.3	8.7 to 9.1
Ø9.52	1.8	12.8 to 13.2
Ø12.70	2.0	16.2 to 16.6
Ø15.88	2.2	19.3 to 19.7
Ø19.05	2.2	23.6 to 24.0

- 5 Check that the flaring is correct, referring to the illustrations below for examples of incorrect flaring.

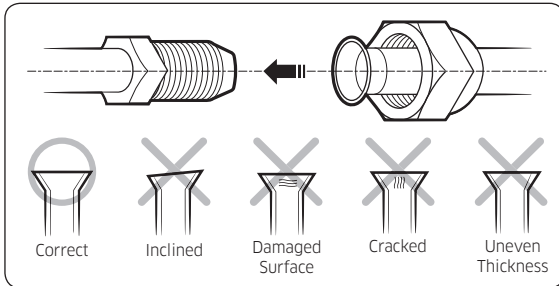

⚠ CAUTION

- If the pipes require brazing ensure that OFN (Oxygen Free Nitrogen) is flowing through the system.
- Nitrogen blowing pressure range is 0.02 ~ 0.05MPa.

Step 7 Performing the gas leak test

To identify potential gas leaks on the indoor unit, inspect the connection area of each refrigerant pipe using a leak detector for R-410A.

Before recreating the vacuum and recirculating the refrigerant gas, pressurize the whole system with nitrogen (using a cylinder with a pressure reducer) at a pressure above 4 MPa in order to immediately detect leaks on the refrigerant fittings.

Made vacuum for 15 minutes and pressurizing system with nitrogen.

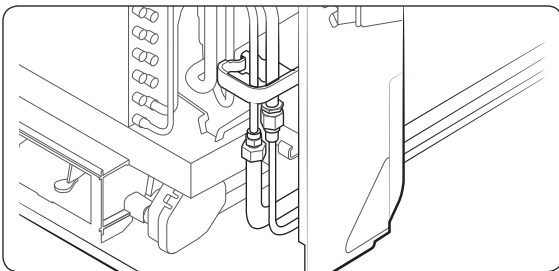

⚠ CAUTION

- If the pipes require brazing ensure that OFN (Oxygen Free Nitrogen) is flowing through the system.

Step 8 Insulating the refrigerant pipes

Once you have checked that there are no leaks in the system, you can insulate the piping and hose.

- 1 To avoid condensation problems, place Acrylonitrile Butadiene Rubber separately around each refrigerant pipe.

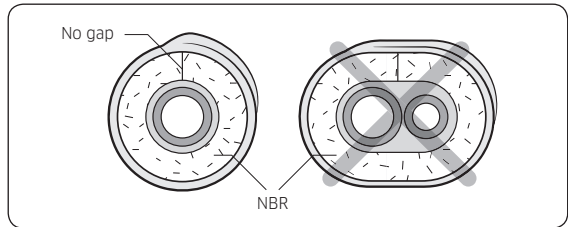

📖 NOTE

- Always make the seam of pipes face upwards.

⚠ CAUTION

- The insulation has to be produced in full compliance of European regulation reg. EEC / EU 2037/ 2000 that requires the use of sheaths insulation form without using CFC and HCFC gases for health and the environment.
- 2 Wind insulating tape around the pipes and drain hose avoiding compressing the insulation too much.

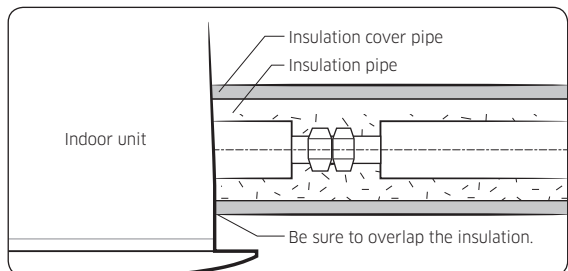

⚠ CAUTION

- Be sure to wrap insulation tightly without any gaps.

Installation Procedure

- 3 Finish wrapping insulating tape around the rest of the pipes leading to the outdoor unit.
- 4 The pipes and electrical cables connecting the indoor unit with the outdoor unit must be fixed to the wall with suitable ducts.
- 5 Select the insulation of the refrigerant pipe.
 - Insulate the gas side and liquid side pipe, noting the insulation thickness that must differ according to the pipe size.
 - Standard: Less than an indoor temperature of 30°C, with humidity at 85%. If installing in a high humidity environment, use one grade thicker insulator by referring to the table below. If installing in an unfavourable environment, use thicker one.
 - The heat-resistance temperature of the insulator must be more than 120°C.

CAUTION

- Make sure that all refrigerant connection must be accessible for easy maintenance and detachment.

Pipe	Pipe size	Insulation type (heating/cooling)		Remarks
		Standard (Less than 30°C, 85%)	High humidity (Over 30°C, 85%)	
		EPDM, NBR		
Liquid pipe	Ø6.35 to Ø9.52	9t	9t	The internal temperature is higher than 120°C.
	Ø12.7 to Ø19.05	13t	13t	
Gas pipe	Ø6.35	13t	19t	
	Ø9.52	19t	25t	
	Ø12.70			
	Ø15.88			
	Ø19.05			

- When installing insulation in the places and conditions below, use the same insulation that is used for high humidity conditions.

<Geological condition>
High humidity locations such as shorelines, hot springs, lake or riversides, and ridges (when part of the building is covered by earth and sand)
<Operation purpose condition>
Restaurant ceiling, sauna, swimming pool etc.
<Building construction condition>
Ceilings frequently exposed to moisture and cooling are not covered. For example, pipes installed at a corridor of a dormitory and studio or near an exit that opens and closes frequently. Places (where the pipes are installed) that are highly humid due to a lack of ventilation.

Step 9 Installing the drain hose and drain pipe

When installing the drain hose for the indoor unit, check if condensation draining is adequate. When passing the drain hose through the 65-mm hole drilled in the wall, check the following:

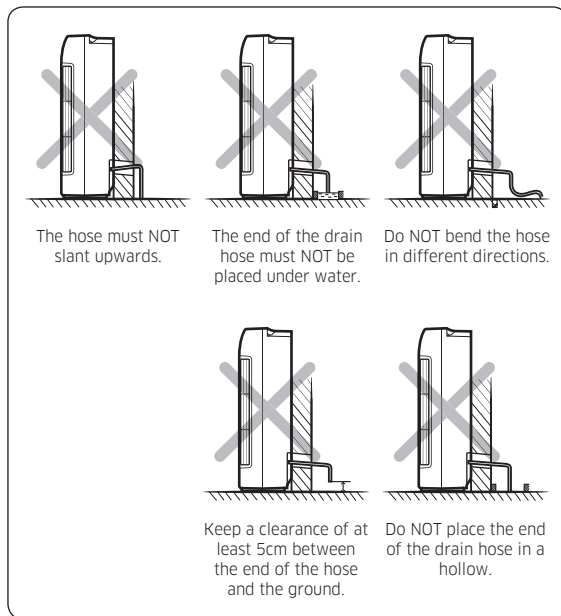

- 1 If necessary, connect the 2-meter extension drain hose to the drain hose.

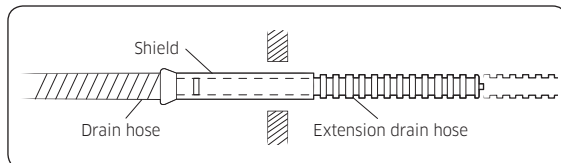

- 2 If you use the extension drain hose, insulate the inside of the extension drain hose with a shield.
- 3 Fit the drain hose into 1 of 2 drain hose holes, then fix the end of the drain hose tightly with a clamp.
 - If you don't use the other drain hose hole, block it with a rubber stopper.
- 4 Pass the drain hose under the refrigerant pipe, keeping the drain hose tight.
- 5 Pass the drain hose through the hole in the wall. Check if it slants downwards as seen in the picture.

6-ways for drain hose and drain pipe connection

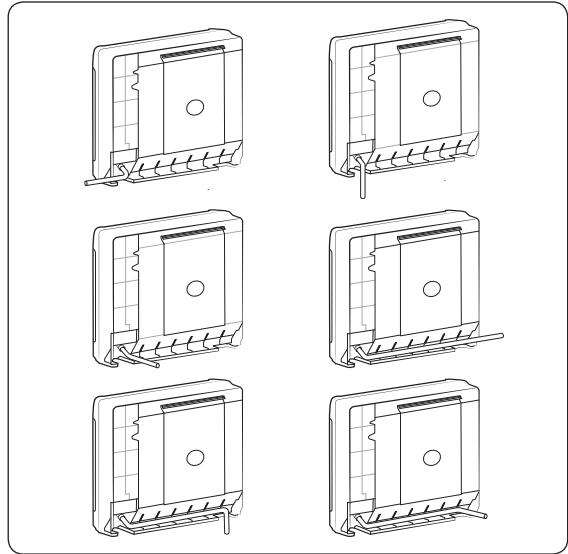

Knock out

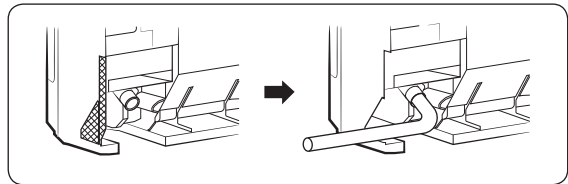

NOTE

- The hose will be fixed permanently into position after finishing the installation and the gas leak test; refer to page 12 for further details.

Step 10 Optional: Installing DPM

- When installing DPM, you should set "DPM setting" to the outdoor unit.
- If DPM model is not set, communication error may occur.
- While the outdoor unit is tracking the indoor unit for one minute after the power supply is turned on, the operation may stop if the remote control reception signal of the installed indoor unit is different.
- When DPM is installed, Automatic Air-Volume function cannot be performed simultaneously for all indoor units. Automatic Air-Volume function must be performed for each indoor unit with the wired remote control attached.

Installation Procedure

Step 11 Connecting the power and communication cables

⚠ CAUTION

- Always remember to connect the refrigerant pipes before performing the electric connections. When disconnecting the system, always disconnect the electric cables before disconnecting the refrigerant pipes.

⚠ CAUTION

- Always remember to connect the air conditioner to the grounding system before performing the electric connections. Use a crimp ring terminal at the end of each wire.

The indoor unit is powered through the outdoor unit by means of a HO7 RN-F connection cable (or a more power model), with insulation in synthetic rubber and a jacket in polychloroprene (neoprene), in accordance with the requirements specified in the standard EN 60335-2-40.

- Remove the screw on the electrical component box and remove the cover plate.
- Route the connection cord through the side of the indoor unit and connect the cable to the terminals refer to the figure below.
- Route the other end of the cable to the outdoor unit through the ceiling & the hole on the wall.
- Reassemble the electrical component box cover, carefully tightening the screw.

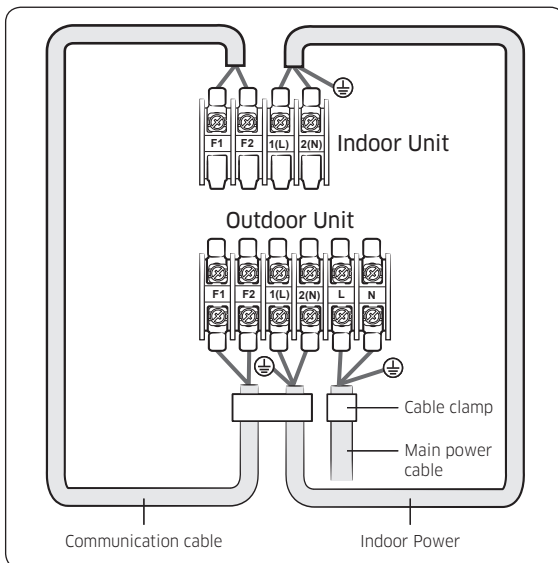

Indoor power supply		
Power supply	Max/Min(V)	Indoor power cable
220 to 240V, 50 Hz	±10%	0.75 to 1.5 mm ² , 3 wires
Communication cable		
0.75 to 1.5 mm ² , 2 wires		

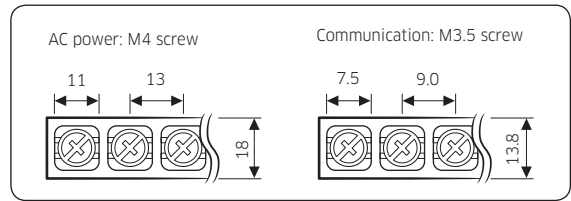

Tightening torque (kgf • cm)	
M3.5	8.0 to 12.0
M4	12.0 to 18.0

- 1 N·m = 10 kgf·cm
- Power supply cords of parts of appliances for outdoor use shall not be lighter than polychloroprene sheathed flexible cord. (Code designation IEC:60245 IEC 57 / CENELEC: H05RN-F or IEC:60245 IEC 66 / CENELEC: H07RN-F)
- Screws on terminal block must not be unscrewed with the torque less than 12 kgf·cm.
- Since it has the external power supply, refer to the outdoor unit installation manual for MAIN POWER.

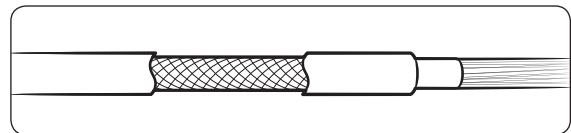





⚠ CAUTION

- When installing the indoor unit in a computer room or network room, use the double shielded communication cable (tape aluminum / polyester braid + copper) of FROHH2R type.

Step 12 Optional: Extending the power cable

1 Prepare the following tools.

Tools	Spec	Shape
Crimping pliers	MH-14	
Connection sleeve (mm)	20xØ6.5 (HxOD)	
Insulation tape	Width 19 mm	
Contraction tube (mm)	70xØ8.0 (LxOD)	

2 As shown in the figure, peel off the shields from the rubber and wire of the power cable.

- Peel off 20 mm of cable shields from the pre-installed tube.

⚠ CAUTION

- For information about the power cable specifications for indoor and outdoor units, refer to the installation manual.
- After peeling off cable wires from the pre-installed tube, insert a contraction tube.

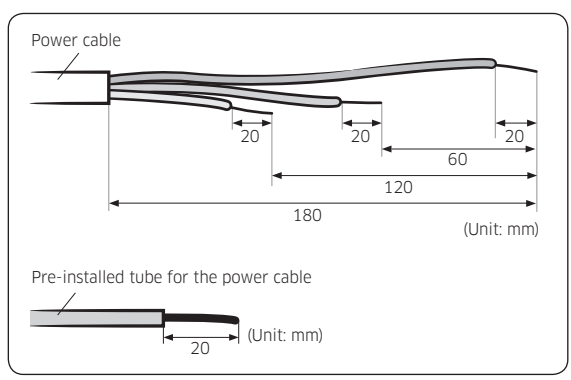

3 Insert both sides of core wire of the power cable into the connection sleeve.

- **Method 1:** Push the core wire into the sleeve from both sides.
- **Method 2:** Twist the wire cores together and push it into the sleeve.

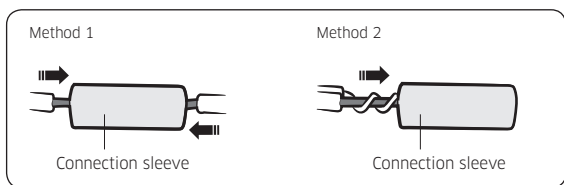

4 Using a crimping tool, compress the two points and flip it over and compress another two points in the same location.

- The compression dimension should be 8.0.

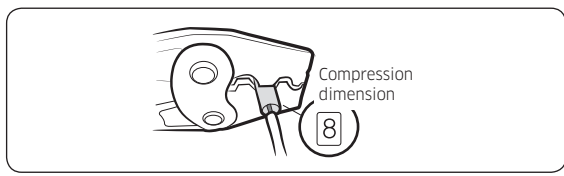

- After compressing it, pull both sides of the wire to make sure it is firmly pressed.

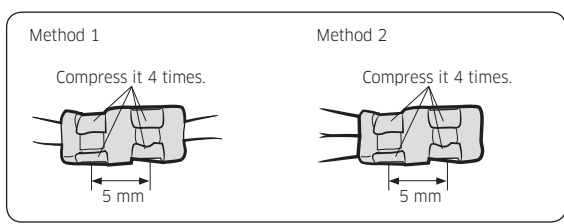

5 Wrap it with the insulation tape twice or more and position your contraction tube in the middle of the insulation tape.

Three or more layers of insulation are required.

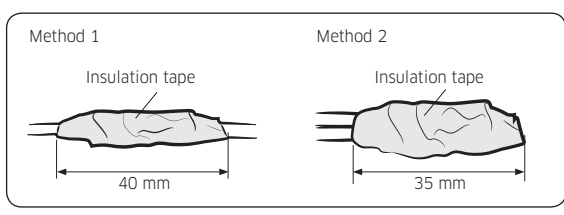

Installation Procedure

6 Apply heat to the contraction tube to contract it.

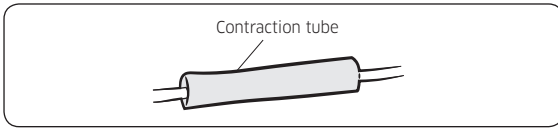

7 After tube contraction work is completed, wrap it with the insulation tape to finish.

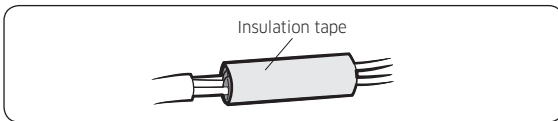

CAUTION

- Make sure that the connection parts are not exposed to outside.
- Be sure to use insulation tape and a contraction tube made of approved reinforced insulating materials that have the same level of withstand voltage with the power cable. (Comply with the local regulations on extensions.)

WARNING

- In case of extending the electric wire, please DO NOT use a round-shaped Pressing socket.
 - Incomplete wire connections can cause electric shock or a fire.

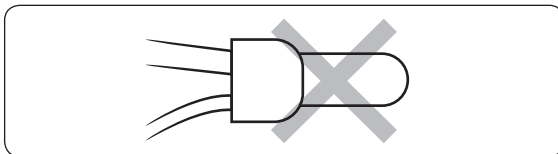

Step 13 Setting the indoor unit addresses and the installation options

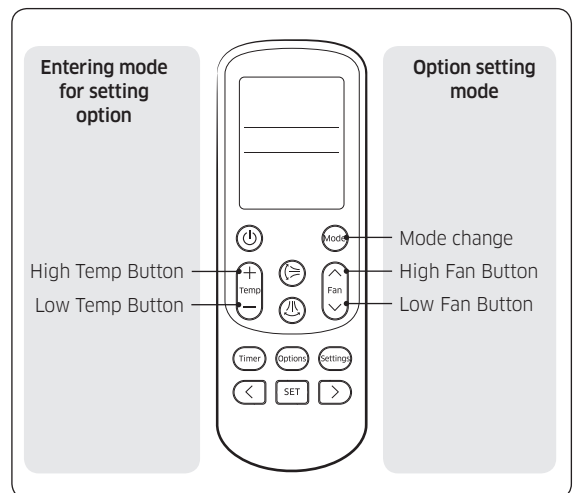

- Set the indoor unit address and installation option with remote controller option. Set the each option separately since you cannot set the ADDRESS setting and indoor unit installation setting option at the same time. You need to set twice when setting indoor unit address and installation option.
- Please use the proper wireless remote controller which can set 24 digit option code.
- Please refer to the wired remote controller installation manual for setting with the wired remote controller.

Common steps for setting the addresses and options



NOTE

- The remote control display and buttons may vary depending on the model.

- 1 Enter the mode for setting the options:
 - a Remove the batteries from the remote control, and then insert them again.
 - b While holding down the  (High Temp) and  (Low Temp) buttons simultaneously, insert the batteries into the remote control.
 - c Make sure that you are entered to the mode for setting the options:

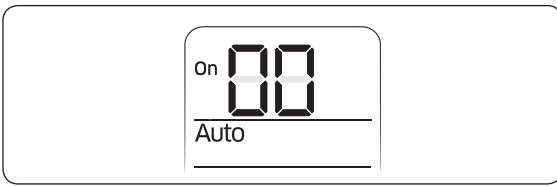

- 2 Set the option values.

CAUTION





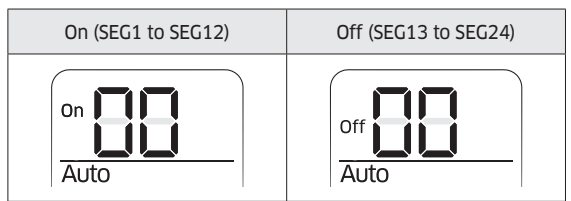

- The total number of available options are 24: SEG1 to SEG24.
- Because SEG1, SEG7, SEG13, and SEG19 are the page options used by the previous remote control models, the modes to set values for these options are skipped automatically.

- Set a 2-digit value for each option pair in the following order: SEG2 and SEG3 → SEG4 and SEG5 → SEG6 and SEG8 → SEG9 and SEG10 → SEG11 and SEG12 → SEG14 and SEG15 → SEG16 and SEG17 → SEG18 and SEG20 → SEG21 and SEG22 → SEG23 and SEG24



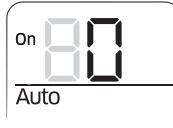

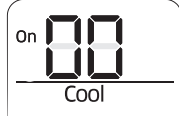

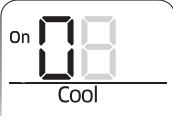
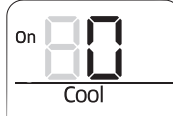











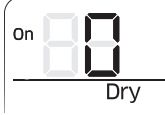









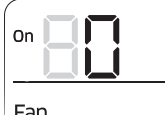

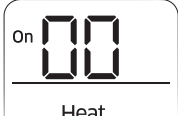





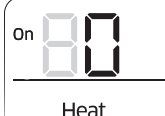

SEG1	SEG2	SEG3	SEG4	SEG5	SEG6
0	X	X	X	X	X
SEG7	SEG8	SEG9	SEG10	SEG11	SEG12
1	X	X	X	X	X
SEG13	SEG14	SEG15	SEG16	SEG17	SEG18
2	X	X	X	X	X
SEG19	SEG20	SEG21	SEG22	SEG23	SEG24
3	X	X	X	X	X













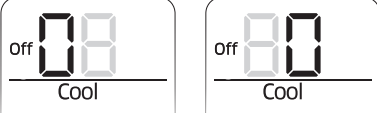

Take the steps presented in the following table:

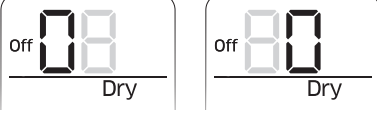
Option setting	Status
1 Setting SEG2, SEG3 option Press Low Fan button  to enter SEG2 value. Press High Fan button  to enter SEG3 value. Each time you press the button, → → ... → → will be selected in rotation.	  SEG2 SEG3
2 Setting Cool mode  Press Mode button to be changed to Cool mode in the ON status.	
3 Setting SEG4, SEG5 option Press Low Fan button  to enter SEG4 value. Press High Fan button  to enter SEG5 value. Each time you press the button, → → ... → → will be selected in rotation.	  SEG4 SEG5

Installation Procedure

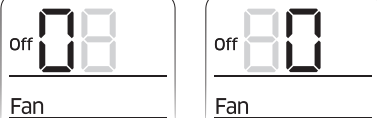
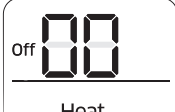
Option setting	Status
<p>4 Setting Dry mode</p> <p> Press Mode button to be changed to DRY mode in the ON status.</p>	
<p>5 Setting SEG6, SEG8 option</p> <p>Press Low Fan button  to enter SEG6 value.</p> <p>Press High Fan button  to enter SEG8 value.</p> <p>Each time you press the button,  →  → ... →  →  will be selected in rotation.</p>	 
<p>6 Setting Fan mode</p> <p> Press Mode button to be changed to FAN mode in the ON status.</p>	
<p>7 Setting SEG9, SEG10 option</p> <p>Press Low Fan button  to enter SEG9 value.</p> <p>Press High Fan button  to enter SEG10 value.</p> <p>Each time you press the button,  →  → ... →  →  will be selected in rotation.</p>	 
<p>8 Setting Heat mode</p> <p> Press Mode button to be changed to HEAT mode in the ON status.</p>	
<p>9 Setting SEG11, SEG12 option</p> <p>Press Low Fan button  to enter SEG11 value.</p> <p>Press High Fan button  to enter SEG12 value.</p> <p>Each time you press the button,  →  → ... →  →  will be selected in rotation.</p>	 
<p>10 Setting Auto mode</p> <p> Press Mode button to be changed to AUTO mode in the OFF status.</p>	
<p>11 Setting SEG14, SEG15 option</p> <p>Press Low Fan button  to enter SEG14 value.</p> <p>Press High Fan button  to enter SEG15 value.</p> <p>Each time you press the button,  →  → ... →  →  will be selected in rotation.</p>	 

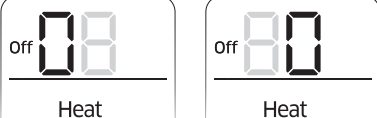
Option setting	Status
<p>12 Setting Cool mode</p> <p>⊙ Press Mode button to be changed to Cool mode in the OFF status.</p>	
<p>13 Setting SEG16, SEG17 option</p> <p>Press Low Fan button  to enter SEG16 value.</p> <p>Press High Fan button  to enter SEG17 value.</p> <p>Each time you press the button, $\square \rightarrow \updownarrow \rightarrow \dots \text{E} \rightarrow \text{F}$ will be selected in rotation.</p>	 <p style="text-align: center;">SEG16 SEG17</p>
<p>14 Setting Dry mode</p> <p>⊙ Press Mode button to be changed to Dry mode in the OFF status.</p>	
<p>15 Setting SEG18, SEG20 option</p> <p>Press Low Fan button  to enter SEG18 value.</p> <p>Press High Fan button  to enter SEG20 value.</p> <p>Each time you press the button, $\square \rightarrow \updownarrow \rightarrow \dots \text{E} \rightarrow \text{F}$ will be selected in rotation.</p>	 <p style="text-align: center;">SEG18 SEG20</p>
<p>16 Setting Fan mode</p> <p>⊙ Press Mode button to be changed to Fan mode in the OFF status.</p>	
<p>17 Setting SEG21, SEG22 option</p> <p>Press Low Fan button  to enter SEG21 value.</p> <p>Press High Fan button  to enter SEG22 value.</p> <p>Each time you press the button, $\square \rightarrow \updownarrow \rightarrow \dots \text{E} \rightarrow \text{F}$ will be selected in rotation.</p>	 <p style="text-align: center;">SEG21 SEG22</p>
<p>18 Setting Heat mode</p> <p>⊙ Press Mode button to be changed to HEAT mode in the OFF status.</p>	
<p>19 Setting SEG23, SEG24 option</p> <p>Press Low Fan button  to enter SEG23 value.</p> <p>Press High Fan button  to enter SEG24 value.</p> <p>Each time you press the button, $\square \rightarrow \updownarrow \rightarrow \dots \text{E} \rightarrow \text{F}$ will be selected in rotation.</p>	 <p style="text-align: center;">SEG23 SEG24</p>

Installation Procedure

3 Check whether the option values that you have set are correct by pressing the  button repeatedly.

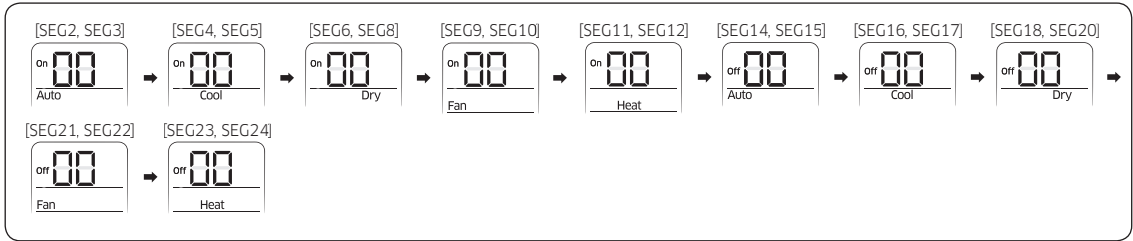

4 Save the option values into the indoor unit:

Press the  button with the direction of remote control for set. For correcting option values, input the option values twice.

5 Check whether the air conditioner operates in accordance with the option values you have set:

- a Reset the indoor unit by pressing the Reset button on the indoor or outdoor unit.
- b Remove the batteries from the remote control, insert them again, and then press the  button on the remote control.

Setting the indoor unit addresses

- 1 Make sure that the power is supplied to the indoor unit. If the indoor unit is not plugged in, it must include a power supply.
- 2 The panel(display) should be connected to an indoor unit to receive option.
- 3 Before installing the indoor unit, assign an address to the indoor unit according to the air conditioning system plan.
- 4 Assign an indoor unit address by wireless remote controller.
 - The initial indoor unit ADDRESS is set as "MAIN : 0, RMC : 0".
 - Set Main and RMC Address only the setting is required.
 - There is no need to assign the indoor unit Main Address if the outdoor unit is addressing automatically. The indoor unit Main address will follow the outdoor unit's automatically.
 - Assign 12 digit when setting the indoor unit address.
 - No need to assign SEG4, 5, 8, 10 which are non applicable. Even though those segments are set, they will be ignored.
 - If you set the applicable segments with numbers other than the indicated, the initial setting will be maintained.

Option No. : 0AXXXX-1XXXXX-2XXXXX-3XXXXX

Option	SEG1		SEG2		SEG3		SEG4	SEG5	SEG6	
Explanation	PAGE		MODE		Setting Main address		RESERVED	RESERVED	The unit digit of an indoor unit	
Indication and Details	Indication	Details	Indication	Details	Indication	Details			Indication	Details
	0		A		0	No Main address			0~3(ACN*)	A single digit
				1	Main address setting mode	0~4 (AJN*)				

Option	SEG7		SEG8	SEG9		SEG10	SEG11		SEG12	
Explanation	PAGE		RESERVED	Setting RMC address		RESERVED	Group channel(*16)		Group address	
Indication and Details	Indication	Details		0	No RMC address		RMC1	0~2	RMC2	0~F
	1			1	RMC address setting mode					

*SEG6: AJN** models should check maximum installation indoor unit number of outdoor unit.
(Indoor1: 0, Indoor2: 1, ~)

CAUTION

- When "A"~"F" is entered to SEG5~6, the indoor unit MAIN ADDRESS is not changed.
- If you set the SEG 3 as 0, the indoor unit will maintain the previous MAIN ADDRESS even if you input the option value of SEG6.
- If you set the SEG 9 as 0, the indoor unit will maintain previous RMC ADDRESS even if you input the option value of SEG11~12.

Example) If you want to set as "MAIN: 3, CHANNEL: 1, RMC: B",

SEG1	SEG2	SEG3	SEG4	SEG5	SEG6
0	A	1	-	-	3
SEG7	SEG8	SEG9	SEG10	SEG11	SEG12
1	-	1	-	1	B

assign option codes except SEG 1, 7 which are page options.

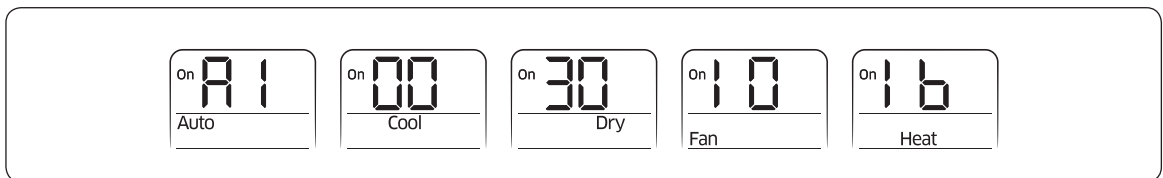

Installation Procedure

Setting the installation options in a batch

- 1 Make sure that the power is supplied to the indoor unit. If the indoor unit is not plugged in, it must include a power supply.
- 2 The panel(display) should be connected to an indoor unit to receive option.
- 3 Set the installation option according to the installation condition of an air conditioner.
 - The default setting of an indoor unit installation option is "02000-100000-200000-300000".
 - Individual control of a remote controller(SEG20) is the function that controls an indoor unit individually when there is more than one indoor unit.
 - No need to assign SEG3, 6, 9, 10, 11, 16, 21, 22, 23, 24 which are non applicable. Even though those segments are set, they will be ignored.
 - If you set the applicable segments with numbers other than the indicated, the initial setting will be maintained.
- 4 Set the indoor unit option by wireless remote controller.

Option No. : 02XXXX-1XXXXX-2XXXXX-3XXXXX

Option	SEG1		SEG2		SEG3	SEG4		SEG5		SEG6
Explanation	PAGE		MODE		RESERVED	Use of external temperature sensor		Indoor unit number		RPM setting compensation
Indication and details	Indication	Details	Indication	Details		Indication	Details	Indication	Details	0. Not used 1. High ceiling mode 2. High ceiling kit 3. Low noise operation mode
	0		A			0	Disuse	0	Disuse	
					1	Use	1	Use		
Option	SEG7		SEG8		SEG9	SEG10	SEG11		SEG12	
Explanation	PAGE		Use of drain pump		RESERVED	RESERVED	RESERVED	Group address		
Indication and details	Indication	Details	Indication	Details				Indication	Details	
	1		0	Disuse				0	slave	
			1	Use				1	master	
			2	Use + 3minute delay						

Option	SEG13		SEG14			SEG15		SEG16		SEG17		SEG18		
Explanation	PAGE		Use of external control			Setting RMC address		Setting RMC address		Group channel (x16)		Group address		
Indication and details	Indication	Details	Indication	Details		Indication	Details	Indication	Details	Indication	Details	Indication	Details	
	2	0	Disuse	0	On/Off control	Slave (disable Level control*)	1	Thermo on	0	Disuse	0	Mixed operation control 1/Use buzzer	2	1000 Hour
		1	On/Off control											
		2	Off control											
		3	Window on/off control	1	Use	1					Mixed operation control 1/Disuse of buzzer			
		4	Disuse			2					Mixed operation control 2/Use buzzer			
		5	On/Off control											
		6	Off control											
7	Window on/off control	3	Mixed operation control 2/Disuse of buzzer	6	2000 Hour									
Option	SEG19		SEG20			SEG21		SEG22		SEG23		SEG24		
Explanation	PAGE		Individual control of a remote controller			Setting RMC address				Motion detect sensor		Group address		
Indication and details	Indication	Details	Indication	Details		Indication	Details	RESERVED		Indication	Details	RESERVED		
	3	0 or 1	Indoor 1	0	Disuse	1	2°C			0	No Use (Factory Setting)			
		2	Indoor 2							1	Standard Mode/ Auto Set OFF30 Min.			
		3	Indoor 3							2	Standard Mode/ Auto Set OFF60 Min.			
	4	Indoor 4	2	5°C	3					Standard Mode/ Auto Set OFF 120 Min.				
4					Standard Mode/ Auto Set OFF 180 Min.									
				5	Premium Mode/ Auto Set OFF30 Min.									
				6	Premium Mode/ Auto Set OFF60 Min.									
				7	Premium Mode/ Auto Set OFF 120 Min.									
				8	Premium Mode/ Auto Set OFF 180 Min.									

Installation Procedure

If you input a number other than 0~4 on the individual control of the indoor unit(SEG 20), the indoor is set as "Indoor 1".

Example) If you want to set as "Exterior temperature sensor : USE, External control : USE, Number of hours using filter : 2000hr",

SEG1	SEG2	SEG3	SEG4	SEG5	SEG6
0	2	-	1	0	-
SEG7	SEG8	SEG9	SEG10	SEG11	SEG12
1	0	-	-	-	0
SEG13	SEG14	SEG15	SEG16	SEG17	SEG18
2	1	0	-	0	6
SEG19	SEG20	SEG21	SEG22	SEG23	SEG24
3	0	-	-	-	-

assign option codes except SEG 1, 7, 13, 19 which are page options.

* Level control : The centralized controller can limit the functions and inputs of connected products with this function enabled.

[Example: Operation mode limit (Cooling only/Heating only/No limitation), Heating temperature upper limit, Cooling temperature lower limit]

To enable 'Level control' when applying the DPM with the centralized controller, appoint the master (Set 'Use of external control [SEG14] option to 4 or higher).

Example : When installing DPM (1 Outdoor unit with 4 indoor units)

Condition		SEG 14 Setting				Result
External control	Level control	Indoor 1	Indoor 2	Indoor 3	Indoor 4	
Default		Not set (0)				Slave (All)
Disuse	Use	4	Not set (0)	Not set (0)	Not set (0)	Master (Indoor 1), Slave (Indoor 2,3,4)
Use (Indoor 3)	Disuse	Not set (0)	Not set (0)	1~3	Not set (0)	Slave (All)
Use (Indoor 4)	Use	Not set (0)	Not set (0)	Not set (0)	5~7	Master (Indoor 4), Slave (Indoor 1,2,3)

Changing the addresses and options individually

Example) If you want to set as "MAIN : 3, CHANNEL : 1, RMC : B",

Option	SEG1		SEG2		SEG3		SEG4		SEG5		SEG6	
Explanation	PAGE		MODE		The option mode you want to change		The tens' digit of an option SEG you will change		The unit digit of an option SEG you will change		The changed value	
Indication and Details	Indication	Details	Indication	Details	Indication	Details	Indication	Details	Indication	Details	Indication	Details
	0		D		Option mode	0~F	Tens' digit of SEG	0~9	Unit digit of SEG	0~9	The changed value	0~F

NOTE

- When changing a digit of an indoor unit address setting option, set the SEG3 as 'A'.
- When changing a digit of indoor unit installation option, set the SEG3 as '2'.

Example) When setting the 'buzzer control' into disuse status.

Option	SEG1		SEG2		SEG3		SEG4		SEG5		SEG6	
Explanation	PAGE		MODE		The option mode you want to change		The tens' digit of an option SEG you will change		The unit digit of an option SEG you will change		The changed value	
Indication	0		D		2		1		7		1	

Troubleshooting

- If an error occurs during the operation, one or more LED flickers and the operation is stopped except the LED.
- If you re-operate the air conditioner, it operates normally at first, then detect an error again.

Abnormal condition	Error code	LED Display				
Error on indoor temperature sensor (Short or Open)	E121	×	×	●	×	×
1. Error on Eva-in sensor (Short or Open) 2. Error on Eva-out sensor (Short or Open) 3. Discharge sensor error (Short or Open)	E122 E123 E126	●	×	●	×	×
Indoor fan error	E154	×	×	×	●	×
1. Error on outdoor temperature sensor (Short or Open) 2. Error on cond sensor 3. Error on discharge sensor Other outdoor unit sensor error that is not on the above list	E221 E237 E251	●	×	×	●	×
1. When there is no communication between the indoor•outdoor units for 2 minutes 2. Communication error received from the outdoor unit 3. 3 minute tracking error on outdoor unit 4. Communication error after tracking due to unmatching number of installed units 5. Error due to repeated communication address 6. Communication address not confirmed Other outdoor unit communication error that is not on the above list	E101 E102 E202 E201 E108 E109	×	×	●	●	×
Self diagnosis error display 1. Error due to opened EEV (2nd detection) 2. Error due to closed EEV (2nd detection) 3. Eva in sensor is detached 4. Eva out sensor is detached 5. Thermal fuse error (Open)	E151 E152 E128 E129 E198	×	×	●	●	●
1. COND mid sensor is detached 2. Refrigerant leakage (2nd detection) 3. Abnormally high temperature on Cond (2nd detection) 4. Low pressure s/w (2nd detection) 5. Abnormally high temperature on discharged air on outdoor unit (2nd detection) 6. Indoor operation stop due to unconfirmed error on outdoor unit 7. Error due to reverse phase detection 8. Comp stop due to freeze detection (6th detection) 9. High pressure sensor is detached 10. Low pressure sensor is detached 11. Outdoor unit copression ration error 12. Outdoor sump down_1 prevetion control 13. Compressor down due to low pressure sensor prevention control_1 14. Simultaneous opening of cooling/heating MCU SOL valve (1st detection) 15. Simultaneous opening of cooling/heating MCU SOL valve (2nd detection) Other outdoor unit self-diagnosis error that is not on the above list	E241 E554 E450 E451 E416 E559 E425 E403 E301 E306 E428 E413 E410 E180 E181	×	×	●	●	●
Flowating s/w (2nd detection)	E153	×	×	×	●	●
EEPROM error	E162	●	●	●	●	●
EEPROM option error	E163	●	●	●	●	●
Error due to incompatible indoor unit	E164	×	×	×	×	●

● : On, ● : Flickering, X : Off

If you turn off the air conditioner when the LED is flickering, the LED is also turned off.

Memo

