

Air conditioner

Installation manual

AJ***TN1DKG

- Thank you for purchasing this Samsung air conditioner.
- Before operating this unit, please read this manual carefully and retain it for future reference.



SAMSUNG

Contents

Safety Information	3
Installation Procedure	6
Step 1 Checking and preparing accessories	6
Step 2 Choosing the installation location	6
Step 3 Optional: Insulating the body of the indoor unit	8
Step 4 Installing the indoor unit	8
Step 5 Purging inert gas from the indoor unit	10
Step 6 Cutting and flaring the pipes	10
Step 7 Connecting the assembly pipes to the refrigerant pipes	11
Step 8 Performing the gas leak test	12
Step 9 Insulating the refrigerant pipes	12
Step 10 Installing the drain hose and drain pipe	14
Step 11 Performing the drainage test	16
Step 12 Connecting the power and communication cables	17
Step 13 Optional: Extending the power cable	18
Step 14 Setting the indoor unit addresses and the installation options	20
Appendix	31
Troubleshooting	31

Safety Information

WARNING: Read This Manual

- Read and follow all safety information and instructions before installation, use, or maintenance of this appliance. Incorrect installation, use, or maintenance of this appliance can result in death, serious injury, or property damage. Keep these instructions with this appliance. This manual is subject to change. For the latest version, visit www.samsung.com.

Notices and notes

To make you aware of safety messages and highlighted information, we use the following notices and notes throughout this manual:

WARNING

Hazards or unsafe practices that may result in severe personal injury or death.

CAUTION

Hazards or unsafe practices that may result in minor personal injury or property damage.

IMPORTANT

Information of special interest

NOTE

Supplementary information that may be useful



WARNING: Low burning velocity material (This appliance is filled with R-32.)



The user and installer guides should be read carefully.



The user and installer guides should be read carefully.



The service guide should be read carefully.

WARNING

The installation and testing of this appliance must be performed by a qualified technician.

- The instructions in this manual are not intended as a substitute for proper training or adequate experience in the safe installation of the appliance.

Always install the air conditioner in compliance with current local, state, and federal safety standards.

General information

WARNING

- Carefully read the content of this manual before installing the air conditioner and store the manual in a safe place in order to be able to use it as reference after installation.
- For maximum safety, installers should always carefully read the following warnings.
- Store the operation and installation manual in a safe location and remember to hand it over to the new owner if the air conditioner is sold or transferred.
- This manual explains how to install an indoor unit with a split system with two SAMSUNG units. The use of other types of units with different control systems may damage the units and invalidate the warranty. The manufacturer shall not be responsible for damages arising from the use of non compliant units.
- The manufacturer shall not be responsible for damage originating from unauthorized changes or the improper connection of electric and requirements set forth in the "Operating limits" table, included in the manual, shall immediately invalidate the warranty.
- The air conditioner should be used only for the applications for which it has been designed: the indoor unit is not suitable to be installed in areas used for laundry.
- Do not use the units if damaged. If problems occur, switch the unit off and disconnect it from the power supply.
- In order to prevent electric shocks, fires or injuries, always stop the unit, disable the protection switch and contact SAMSUNG's technical support if the unit produces smoke, if the power cable is hot or damaged or if the unit is very noisy.

Safety Information

- Always remember to inspect the unit, electric connections, refrigerant tubes and protections regularly. These operations should be performed by qualified personnel only.
- The unit contains moving parts, which should always be kept out of the reach of children.
- Do not attempt to repair, move, alter or reinstall the unit. If performed by unauthorized personnel, these operations may cause electric shocks or fires.
- Do not place containers with liquids or other objects on the unit.
- All the materials used for the manufacture and packaging of the air conditioner are recyclable.
- The packing material and exhaust batteries of the remote controller(optional) must be disposed of in accordance with current laws.
- The air conditioner contains a refrigerant that has to be disposed of as special waste. At the end of its life cycle, the air conditioner must be disposed of in authorized centres or returned to the retailer so that it can be disposed of correctly and safely.
- Do not use means to accelerate the defrost operation or to clean, other than those recommended by Samsung.
- Do not pierce or burn.
- Be aware that refrigerants may not contain an odour.

Installing the unit

WARNING

IMPORTANT: When installing the unit, always remember to connect first the refrigerant tubes, then the electrical lines.

- Always disassemble the electric lines before the refrigerant tubes.
- Upon receipt, inspect the product to verify that it has not been damaged during transport. If the product appears damaged, DO NOT INSTALL it and immediately report the damage to the carrier or retailer (if the installer or the authorized technician has collected the material from the retailer.)
- After completing the installation, always carry out a functional test and provide the instructions on how to operate the air conditioner to the user.
- Do not use the air conditioner in environments with hazardous substances or close to equipment that release free flames to avoid the occurrence of fires, explosions or injuries.
- Do not install the product in a place where thermohygrostat is needed (such as server room, machinery room, computer room, etc.). Those places do not provide guaranteed operation condition of the product therefore performance can be poor in these places.
- Do not install the product in a ship or a vehicle (such as a campervan). Salt, vibration or other environmental factor may cause the product malfunction, electric shock or fire.
- Our units must be installed in compliance with the space specifications presented in the installation manual in order to ensure accessibility from both sides and allow repairs or maintenance operations to be carried out. The unit's components must be accessible and easy to disassemble without endangering people and objects. For this reason, where it is not observed as indicated into the Installation Manual, the cost necessary to reach and repair the unit (in safety, as required by current regulations in force) with slings, trucks, scaffolding or any other means of elevation won't be considered in-warranty and charged to end user.

Power supply line, fuse or circuit breaker

WARNING

- Always make sure that the power supply is compliant with current safety standards. Always install the air conditioner in compliance with current local safety standards.
- Always verify that a suitable grounding connection is available.
- Verify that the voltage and frequency of the power supply comply with the specifications and that the installed power is sufficient to ensure the operation of any other domestic appliance connected to the same electric lines.
- Always verify that the cut-off and protection switches are suitably dimensioned.
- Verify that the air conditioner is connected to the power supply in accordance with the instructions provided in the wiring diagram included in the manual.
- Always verify that electric connections (cable entry, section of leads, protections...) are compliant with the electric specifications and with the instructions provided in the wiring scheme. Always verify that all connections comply with the standards applicable to the installation of air conditioners.
- Devices disconnected from the power supply should be completely disconnected in the condition of overvoltage category.
- Be sure not to perform power cable modification, extension wiring, and multiple wire connection.
 - It may cause electric shock or fire due to poor connection, poor insulation, or current limit override.
 - When extension wiring is required due to power line damage, refer to Step 13 Optional: Extending the power cable in the installation manual.

CAUTION

Make sure that you earth the cables.

- Do not connect the earth wire to the gas pipe, water pipe, lighting rod or telephone wire. If earthing is not complete, electric shock or fire may occur.

Install the circuit breaker.

- If the circuit breaker is not installed, electric shock or fire may occur.

Make sure that the condensed water dripping from the drain hose runs out properly and safely.

Install the power cable and communication cable of the indoor and outdoor unit at least 1m away from the electric appliance.

Install the indoor unit away from lighting apparatus using the ballast.

- If you use the wireless remote control, reception error may occur due to the ballast of the lighting apparatus.



Do not install the air conditioner in following places.

- Place where there is mineral oil or arsenic acid. Resin parts flame and the accessories may drop or water may leak. The capacity of the heat exchanger may reduce or the air conditioner may be out of order.
- The place where corrosive gas such as sulphuric acid gas generates from the vent pipe or air outlet.
- The copper pipe or connection pipe may corrode and refrigerant may leak.
- The place where there is a machine that generates electromagnetic waves. The air conditioner may not operate normally due to control system.
- The place where there is a danger of existing combustible gas, carbon fibre or flammable dust.
- The place where thinner or gasoline is handled. Gas may leak and it may cause fire.

Installation Procedure

Step 1 Checking and preparing accessories

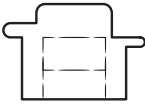
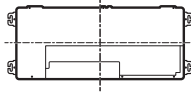
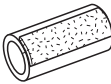
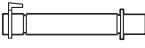
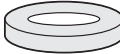
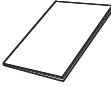
The following accessories are supplied with the indoor unit. The type and quantity may differ, depending on the specifications.

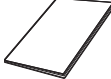
Installation template 	Dimension gauge 	Insulation drain 
Flexible hose 	Rubber 	Installation manual 
Cable-tie 	User manual 	

Step 2 Choosing the installation location

Installation location requirements

- There must be no obstacles near the air inlet and outlet.
- Install the indoor unit on a ceiling that can support its weight.
- Maintain sufficient clearance around the indoor unit.
- Before installing the indoor unit, be sure to check whether the chosen location is well-drained.
- The indoor unit must be installed such that it is beyond public access and is not touchable by users.
- Rigid wall without vibration.
- Where it is not exposed to direct sunshine.
- Where the air filter can be removed and cleaned easily.
- The place where animals may urinate on the product. Ammonia may be generated.
- The place where is close to heat sources.
- Do not use the indoor unit for preservation of food items, plants, equipment, and art works. This may cause deterioration of their quality.
- Do not install the indoor unit if it has any drainage problem.

WARNING

- Because your air conditioner contains R-32 refrigerant, make sure that it is installed, operated, and stored in a room whose floor area is larger than the minimum required floor area specified in the following table:

≤1.842	No requirement
1.843	3.64
1.9	3.75
2.0	3.95
2.2	4.34
2.4	4.74
2.6	5.13
2.8	5.53
3.0	5.92
3.2	6.48
3.4	7.32
3.6	8.20
3.8	9.14
4.0	10.1
4.2	11.2
4.4	12.3
4.6	13.4
4.8	14.6
5.0	15.8

– m : Total refrigerant charge in the system

– A : Minimum required floor area

- **IMPORTANT:** it's mandatory to consider either the table above or taking into consideration the local law regarding the minimum living space of the premises.
- Minimum installation height of indoor unit is 0.6 m for floor mounted, 1.8 m for wall, 2.2 m for ceiling.

CAUTION

- As a rule, the unit cannot be installed at a height of less than 2.5m.
- If you install the cassette or duct type indoor unit on the ceiling with humidity over 80%, you must apply extra 10mm of polyethylene foam or other insulation with similar material on the body of the indoor unit.

Indoor unit dimensions

(Unit: mm)

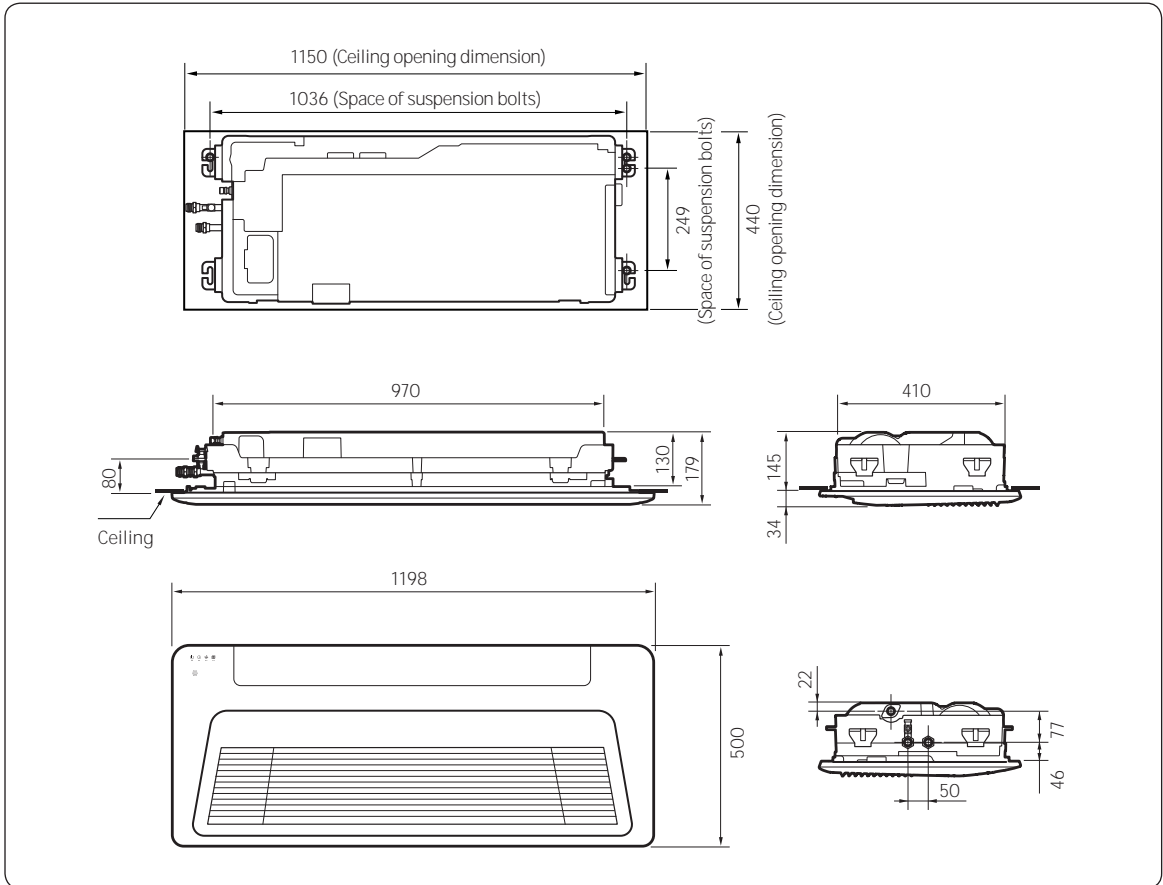

Model		AJ026TN1DKG AJ035TN1DKG
Chassis		Medium
Net dimension (W × D × H)	mm	970 X 410 X 135
Liquid pipe connection		ø6.35 (1/4")
Gas pipe connection		ø9.52 (3/8")
Drain hose connection	mm	VP20 (outer diameter : 26, inner diameter : 20)

Installation Procedure

Spacing requirements

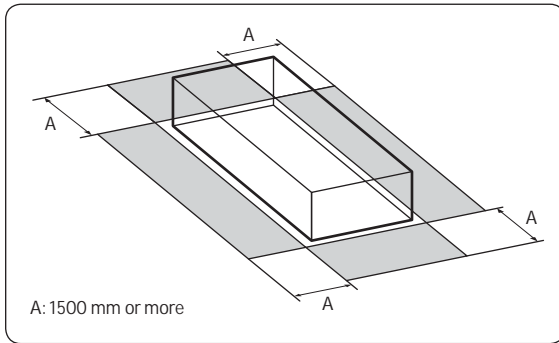

CAUTION

- Comply with the length and height limits described in the figure above.
- For the product that uses the R-32 refrigerant, install the indoor unit on the wall 2.2 m or higher from the floor.
- The indoor unit must be installed according to the specified distances in order to permit accessibility from each side, to guarantee correct operation, maintenance, and repair of the unit. The components of the indoor unit must be reachable and removable under safe conditions for people and the unit.
- Do not hold the discharge while carrying the indoor unit to avoid the possibility of breakage.
- You must hold the hanger plate on the corner and carry the indoor unit.

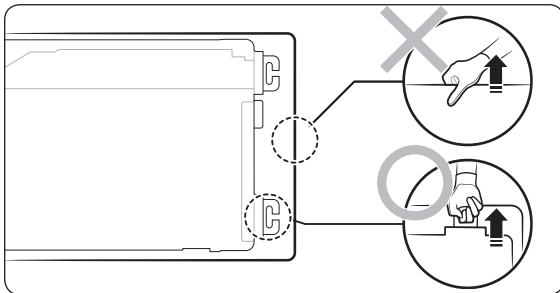

Step 3 Optional: Insulating the body of the indoor unit

If you install a cassette type indoor unit on the ceiling when temperature is over 27°C and humidity is over 80%, you must apply an extra 10 mm thick polyethylene insulation or a similar type of insulation to the body of the indoor unit.

Cut away the part where pipes are pulled out for the insulating work.

Insulate the end of the pipe and some curved area by using separate insulator.

Step 4 Installing the indoor unit

When deciding on the location of the air conditioner the following restrictions must be taken into account.

- 1 Place the pattern sheet on the ceiling at the spot where you want to install the indoor unit.

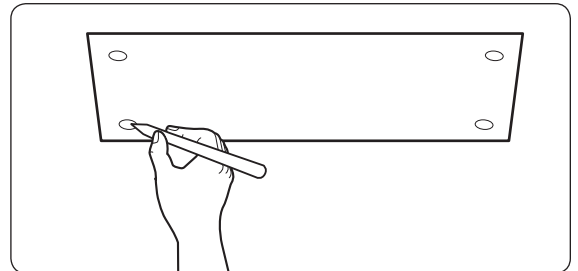

NOTE

- Since the diagram is made of paper, it may shrink or stretch slightly due to temperature or humidity. For this reason, before drilling the holes, be sure to maintain the correct dimensions between the markings.

- 2 Insert bolt anchors, use existing ceiling supports or construct a suitable support as shown in figure.

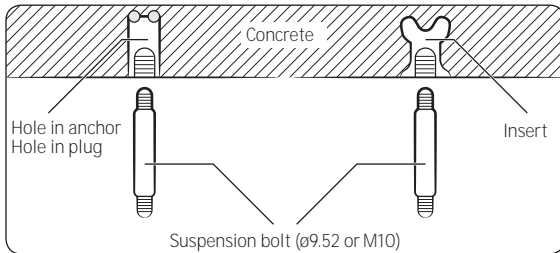

- 3 Install the suspension bolts, depending on the ceiling type.

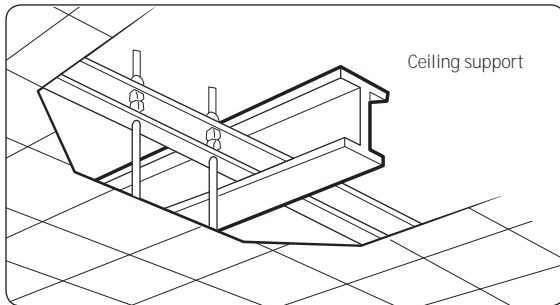

⚠ CAUTION

- Make sure that the ceiling is strong enough to support the weight of the indoor unit. Before hanging the unit, test the strength of each attached suspension bolt.
 - If the length of the suspension bolt is more than 1.5 m, you are required to prevent vibration.
 - If this is not possible, create an opening on the false ceiling in order to be able to use it to perform the required operations on the indoor unit.
- 4 Screw eight nuts and washers to the suspension bolts, making space for hanging the indoor unit.

⚠ CAUTION

- You must install all of the suspension rods.
- It is important to leave sufficient space in the false ceiling to allow access for maintenance or repairs to the drainage pipe connection, the refrigerant pipe connection, or to remove the unit if necessary.

- 5 Hang the indoor unit to the suspension bolts between two nuts. Screw the nuts to suspend the unit. Cut a pad stopper and place it on the bracket at this time.

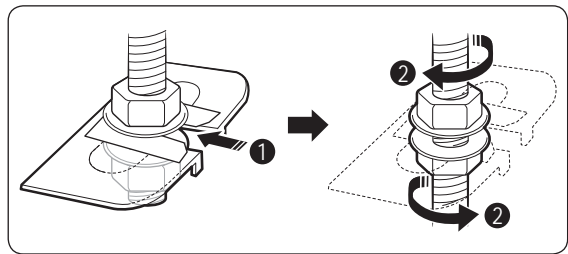

- 6 Check the level of the indoor unit by using a leveler.
 - A tilt of the indoor unit may cause malfunction of a built-in float switch and water leaks.

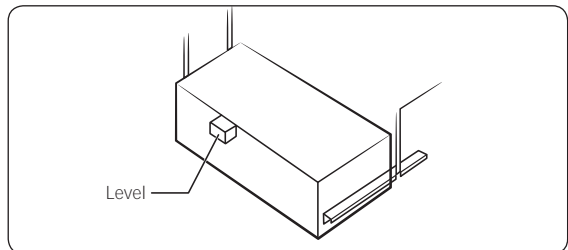

Installation Procedure

- 7 Adjust the unit to the appropriate position, taking into account the installation area for the front panel.
- Place the pattern sheet on the indoor unit.
 - Adjust the space between the ceiling and the indoor unit by using a dimension gauge.
 - Fix the indoor unit securely after adjusting the level of the unit by using a leveller.
 - Remove the pattern sheet and install the front panel.

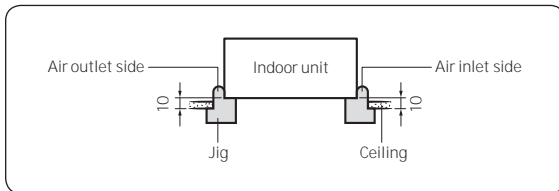

Step 5 Purging inert gas from the indoor unit

The indoor unit comes with nitrogen gas (inert gas) charged at the factory. Therefore, all inert gas must be purged before connecting the assembly piping.

Unscrew the pinch pipe at the end of each refrigerant pipe.

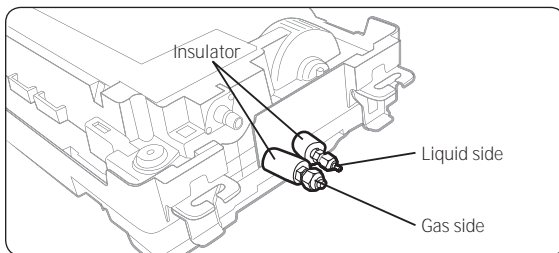

NOTE

- To prevent dirt or foreign objects from getting into the pipes during installation, do not remove the pinch pipe completely until you are ready to connect the piping.

Step 6 Cutting and flaring the pipes

- 1 Make sure that you have the required tools available: pipe cutter, reamer, flaring tool, and pipe holder.
- 2 If you wish to shorten the pipes, cut them with a pipe cutter, ensuring that the cut edge remains at a 90° angle to the side of the pipe. Refer to the illustrations below for examples of edges cut correctly and incorrectly.

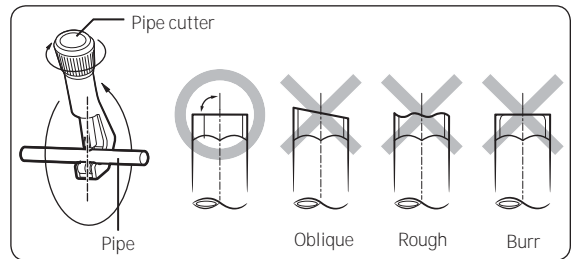

- 3 To prevent any gas from leaking out, remove all burrs at the cut edge of the pipe, using a reamer.
- 4 Slide a flare nut on to the pipe and modify the flare.

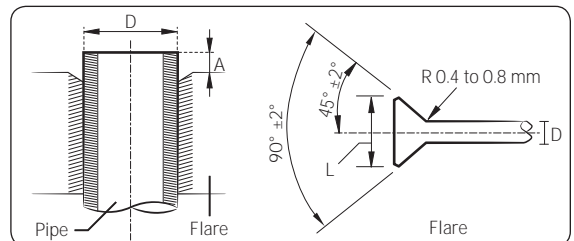

Outer Diameter (D)	Depth (A)	Flare dimension (L)
Ø6.35 mm	1.3 mm	8.7 to 9.1 mm
Ø9.52 mm	1.8 mm	12.8 to 13.2 mm
Ø12.70 mm	2.0 mm	16.2 to 16.6 mm
Ø15.88 mm	2.2 mm	19.3 to 19.7 mm

5 Check that the flaring is correct, referring to the illustrations below for examples of incorrect flaring.

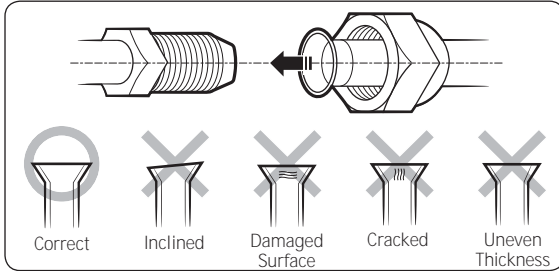

Outer Diameter (mm)	Torque (N·m)
Ø6.35	14 to 18
Ø9.52	34 to 42
Ø12.70	49 to 61
Ø15.88	68 to 82

(1 N·m = 10 kgf·cm)

NOTE

- If the pipes must be shortened, see **Step 6 Cutting and flaring the pipes** on page 10.
- 2 Be sure to use an insulator thick enough to cover the refrigerant tube to protect the condensate water on the outside of the pipe falling onto the floor and to improve the efficiency of the unit.
 - 3 Cut off any excess foam insulation.
 - 4 Make sure that there are no cracks or waves on the bent area.
 - 5 It would be necessary to double the insulation thickness (10 mm or more) to prevent condensation even on the insulator when if the installed area is warm and humid.
 - 6 Do not use joints or extensions for the pipes connecting the indoor and outdoor units. The only permitted connections are those for which the units are designed.

Step 7 Connecting the assembly pipes to the refrigerant pipes

There are two refrigerant pipes of different diameters :

- A smaller one for the liquid refrigerant.
 - A larger one for the gas refrigerant. The inside of copper pipe must be clean and has no dust.
- 1 Remove the pinch pipe on the pipes and connect the assembly pipes to each pipe, tightening the nuts, first manually and then with a torque wrench, a spanner applying the following torque.

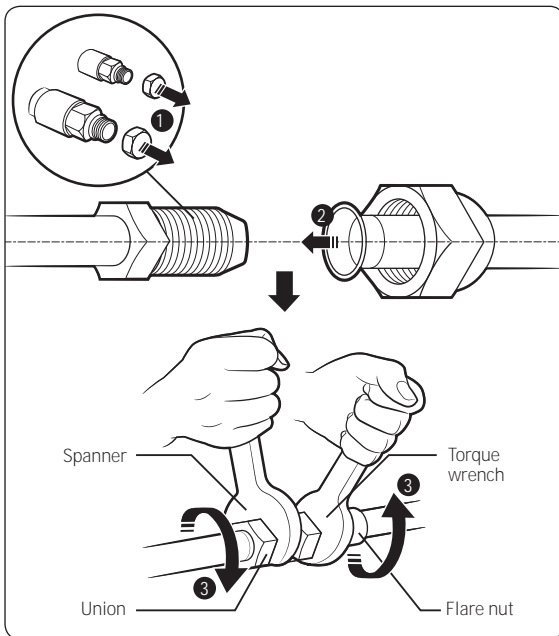

Installation Procedure

⚠ CAUTION

- Connect the indoor and outdoor units using pipes with flared connections (not supplied). For the lines, use insulated, unwelded, degreased and deoxidized copper pipe (Cu DHP type to ISO 1337 or UNI EN 12735-1), suitable for operating pressures of at least 4.2 MPa and for a burst pressure of at least 20.7 MPa. Copper pipe for hydro-sanitary applications is completely unsuitable.
- For sizing and limits (height difference, line length, max. bends, refrigerant charge, etc.) see the outdoor unit installation manual.
- All refrigerant connection must be accessible, in order to permit either unit maintenance or removing it completely.
- If the pipes require brazing, make sure that oxygen free nitrogen (OFN) is flowing through the system.
- Nitrogen blowing pressure range is 0.02 to 0.05 MPa.

Step 8 Performing the gas leak test

To identify potential gas leaks on the indoor unit, inspect the connection area of each refrigerant pipe using a leak detector for R-410A.

Before recreating the vacuum and recirculating the refrigerant gas, pressurize the whole system with nitrogen (using a cylinder with a pressure reducer) at a pressure above 4.1 MPa in order to immediately detect leaks on the refrigerant fittings.

Made vacuum for 15 minutes and pressurizing system with nitrogen.

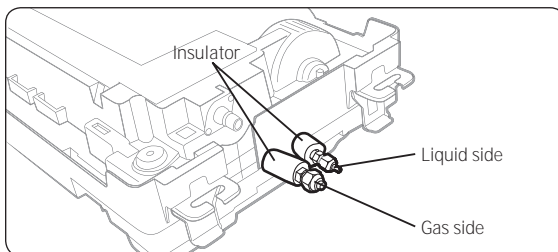

Step 9 Insulating the refrigerant pipes

Once you have checked that there are no leaks in the system, you can insulate the piping and hose.

- 1 To avoid condensation problems, place Acrylonitrile Butadien Rubber separately around each refrigerant pipe.

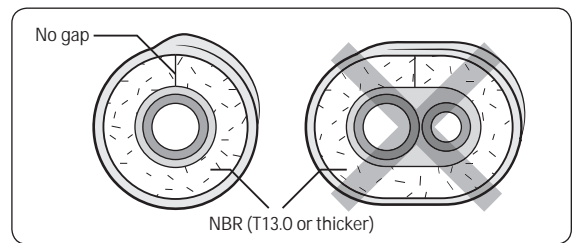

📖 NOTE

- Always make the seam of pipes face upwards.
- 2 Wind insulating tape around the pipes and drain hose avoiding compressing the insulation too much.
 - 3 Finish wrapping insulating tape around the rest of the pipes leading to the outdoor unit.
 - 4 The pipes and electrical cables connecting the indoor unit with the outdoor unit must be fixed to the wall with suitable ducts.

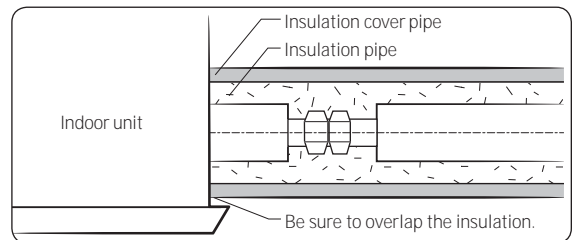

⚠ CAUTION

- Make sure that all refrigerant connection must be accessible for easy maintenance and detachment.
- Must fit tightly against body without any gap.
- Install the insulation not to get wider and use the adhesives on the connection part of it to prevent moisture from entering.
- Wind the refrigerant pipe with insulation tape if it is exposed to outside sunlight.
- Install the refrigerant pipe respecting that the insulation does not get thinner on the bent part or hanger of pipe.
- Add the additional insulation if the insulation plate gets thinner.

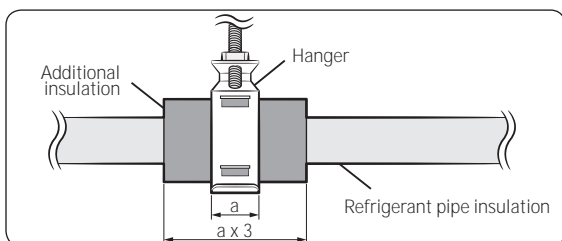

- Must fit tightly against body without any gap.
- All refrigerant connection must be accessible, in order to permit either unit maintenance or removal.

5 Select the insulation of the refrigerant pipe.

- Insulate the gas side and liquid side pipe, noting the insulation thickness that must differ according to the pipe size.
- Standard: Less than an indoor temperature of 30°C, with humidity at 85%. If installing in a high humidity environment, use one grade thicker insulator by referring to the table below. If installing in an unfavourable environment, use thicker one.

- The heat-resistance temperature of the insulator must be more than 120°C.

Pipe	Pipe size	Insulation Type (Heating/Cooling)		Remarks
		Standard [30°C, 85%]	High humidity [30°C, over 85%]	
		EPDM, NBR		
Liquid pipe	Ø6.35 to Ø9.52	9t	9t	Internal temperature is higher than 120°C
	Ø12.7 to Ø50.80	13t	13t	
Gas pipe	Ø6.35	13t	19t	
	Ø9.52 to Ø25.40	19t	25t	
	Ø28.58 to Ø44.45		32t	
	Ø50.80	25t	38t	

- When installing insulation in the places and conditions below, use the same insulation that is used for high humidity conditions.

<Geological condition>
High humidity locations such as shorelines, hot springs, lake or riversides, and ridges (when part of the building is covered by earth and sand)
<Operation purpose condition>
Restaurant ceiling, sauna, swimming pool etc.
<Building construction condition>
Ceilings frequently exposed to moisture and cooling are not covered. For example, pipes installed at a corridor of a dormitory and studio or near an exit that opens and closes frequently.
Places (where the pipes are installed) that are highly humid due to a lack of ventilation.

Installation Procedure

Step 10 Installing the drain hose and drain pipe

- 1 Push the supplied drain hose as near as possible over the drain socket.
- 2 Tighten the metal clamp as shown in the picture.

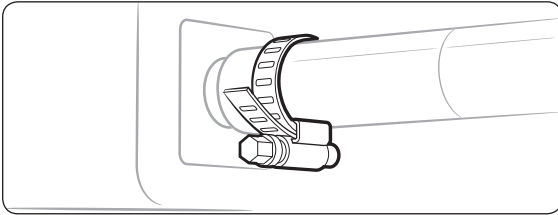

- 3 Wrap the supplied large sealing pad over the metal clamp and drain hose to insulate and fix it with clamps.
- 4 Insulate the complete drain piping inside the building (field supply).
If the drain hose cannot be sufficiently set on a slope, fit the hose with drain raising piping (field supply).
- 5 Push the drain hose up to insulation when connecting the drain hose to drain socket.

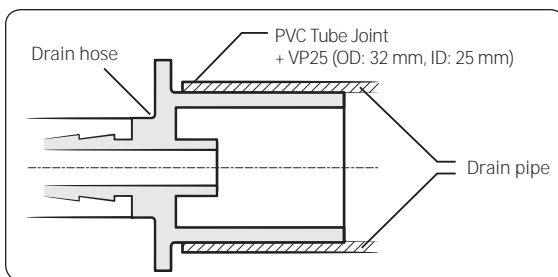
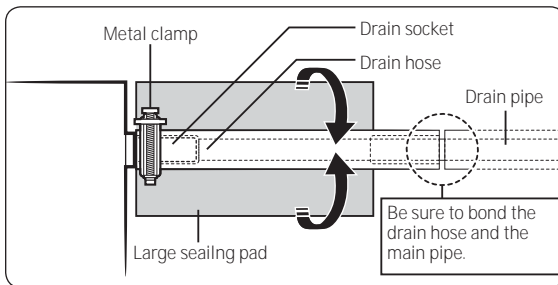

⚠ CAUTION

Check that the indoor unit is level with the ceiling by using the leveller.

- Install air ventilation to drain condensation smoothly.

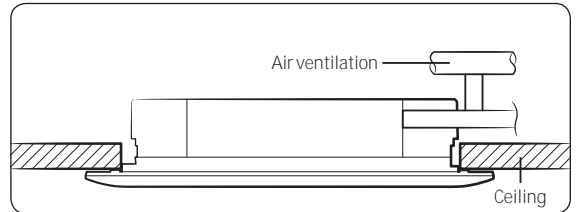

- If it is necessary to increase the height of the drain pipe, install the drain pipe straight within 300 mm from the drain hose port. If it is raised higher than 550 mm, there may be water leaks.

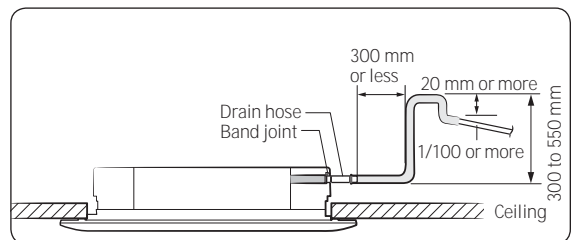

- Do not give the hose an upward gradient beyond the connection port. This will cause water to flow backwards when the unit is stopped, resulting in water leaks.

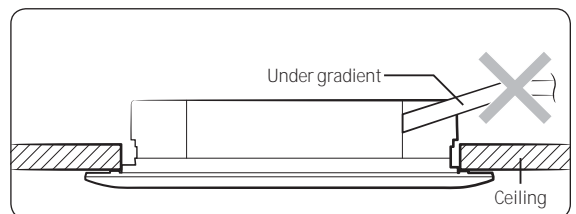

- Do not apply force to the piping on the unit side when connecting the drain hose. The hose should not be allowed to hang loose from its connection to the unit. Fasten the hose to a wall, frame or other support as close to the unit as possible.

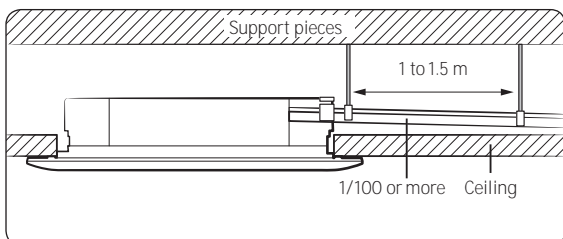

- Install horizontally.

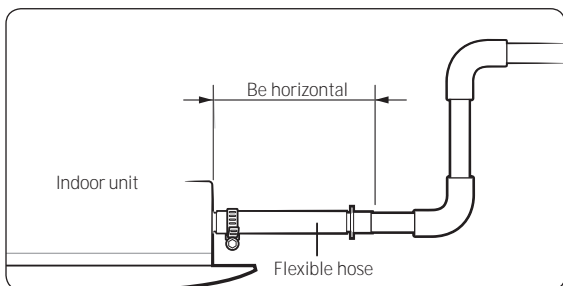

- Max. allowable axis gap

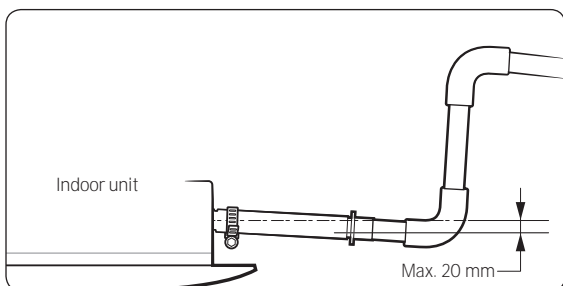

- Max. allowable bending angle

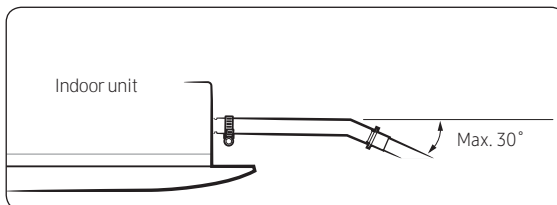

NOTE

- If a concentrated drain pipe is installed, refer to the figure below.

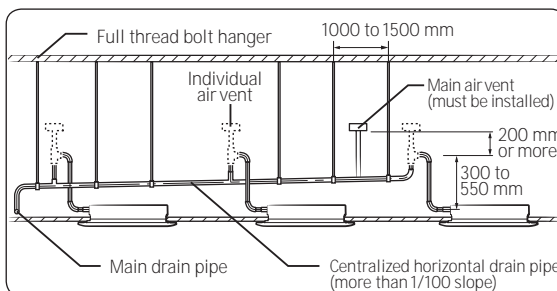

- If 3 or more units are installed, install the main air vent at the front of the farthest indoor unit from the main drain pipe.
- To prevent water from flowing back to indoor units, install an individual air vent at the top of each indoor unit.
 - The air vents should be T or 7 shaped to prevent dust or foreign substances from entering.
 - You may not need to install air vent if the horizontal drain pipe is in proper slope.

Installation Procedure

Step 11 Performing the drainage test

- 1 Do a leak test at the connection part of the flexible hose and the drain pipe:
 - a Connect a general hose to the connection part of the flexible hose of the indoor unit, and pour in some water.

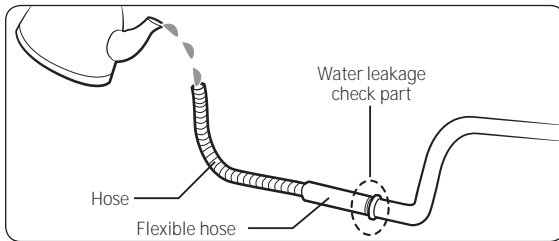

- b After pouring some water, reassemble the rubber cap on the connection part of a flexible hose of the indoor unit and firmly tighten it with a band to prevent leakage.
 - c Check the leak test at the part where the adhesive for the flexible hose and the drain pipe is used.

⚠ CAUTION

- The leak test must be performed for at least 24 hours.

- 2 Check the condensed water drainage:

- a Pour about 2 liters of water into the indoor unit drain pan as shown in the picture.

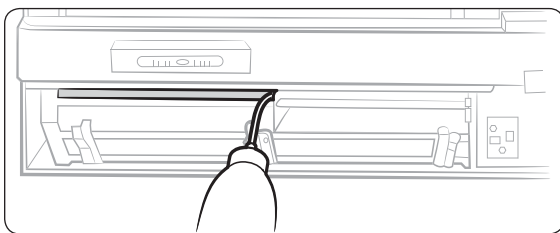

- b When the electric cable connection is completed
 - Turn on the indoor unit and outdoor unit.
 - Operate in the Cool mode.

⚠ CAUTION

- Only in the Cool mode, you can check the correct operation of the drain pump.

When the electric cable connection has not been completed

- Remove the control box cover of the indoor unit.
- Connect the power supply (220 to 240V, 50 Hz) to the L and N terminals.
- Reassemble the control box cover and turn on the indoor unit.

⚠ CAUTION

- When the float switch is not detected due to insufficient water on the drain pan, the drain pump will not work.
 - If the power supply is directly connected to the L and N terminals, communication error message might appear.
 - After completing the drainage check, turn the unit off and disconnect the power supply.
 - Reassemble the control box cover.
- c Check whether the drain pump works correctly.
 - d Check whether the drainage is performing correctly at the end of the drain pipe.
 - e Check for leakage at the drain pipe and drain pipe connection part.
 - f When leakage occurs, check whether the indoor unit is level and check the drain hose connection part, drainpipe connection part and drain pump connection.
 - g When the drainage check is completed and the condensed water remains on the drain pan, remove the water.

Step 12 Connecting the power and communication cables

⚠ CAUTION

- Always remember to connect the refrigerant pipes before performing the electric connections. When disconnecting the system, always disconnect the electric cables before disconnecting the refrigerant pipes.
- For the product that uses the R-32 refrigerant, be cautious not to generate a spark by keeping the following requirements:
 - Do not remove the fuses with power on.
 - Do not disconnect the power plug from the wall outlet with power on.
 - It is recommended to locate the outlet in a high position. Place the cords so that they are not tangled.
- Always remember to connect the air conditioner to the grounding system before performing the electric connections. Use a crimp ring terminal at the end of each wire.

The indoor unit is powered through the outdoor unit by means of a H07 RN-F connection cable (or a more power model), with insulation in synthetic rubber and a jacket in polychloroprene (neoprene), in accordance with the requirements specified in the standard EN 60335-2-40.

- 1 Remove the screw on the electrical component box and remove the cover plate.
- 2 Route the connection cord through the side of the indoor unit and connect the cable to the terminals refer to the figure below.
- 3 Route the other end of the cable to the outdoor unit through the ceiling & the hole on the wall.

- 4 Reassemble the electrical component box cover, carefully tightening the screw.

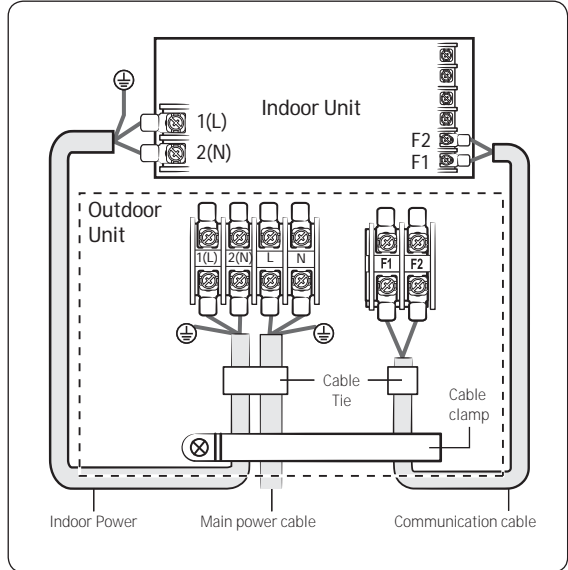

Indoor power supply		
Power supply	Max/Min(V)	Indoor power cable
220 to 240V, 50 Hz	±10%	0.75 to 1.5 mm ² , 3 wires
Communication cable		
0.75 to 1.5 mm ² , 2 wires		

(Unit : mm)

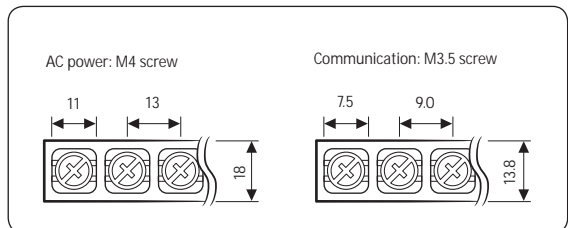

Tightening torque (kgf · cm)	
M3.5	8.0 to 12.0
M4	12.0 to 18.0

- 1 N·m = 10 kgf·cm

Installation Procedure

- Power supply cords of parts of appliances for outdoor use shall not be lighter than polychloroprene sheathed flexible cord. (Code designation IEC:60245 IEC 57 / CENELEC: H05RN-F or IEC:60245 IEC 66 / CENELEC: H07RN-F)
- Since it has the external power supply, refer to the outdoor unit installation manual for MAIN POWER.

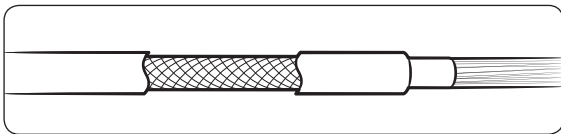

⚠ CAUTION

- When installing the indoor unit in a computer room or network room, use the double shielded communication cable (tape aluminum / polyester braid + copper) of FROHH2R type.
- Connect the power cable to the auxiliary circuit breaker. An all pole disconnection from the power supply must be incorporated in the fixed wiring ($\geq 3\text{mm}$).

Step 13 Optional: Extending the power cable

- 1 Prepare the following tools.

Tools	Spec	Shape
Crimping pliers	MH-14	
Connection sleeve (mm)	20xØ6.5 (HxOD)	
Insulation tape	Width 19 mm	
Contraction tube (mm)	70xØ8.0 (LxOD)	

- 2 As shown in the figure, peel off the shields from the rubber and wire of the power cable.
 - Peel off 20 mm of cable shields from the pre-installed tube.

⚠ CAUTION

- For information about the power cable specifications for indoor and outdoor units, refer to the installation manual.
- After peeling off cable wires from the pre-installed tube, insert a contraction tube.
- If cable wires are connected without using connecting sleeves, their contact area becomes reduced, or corrosion develops on the outer surfaces of the wires (copper wires) over a long time. This may cause an increase of resistance (reduction of passing current) and consequently may result in a fire.

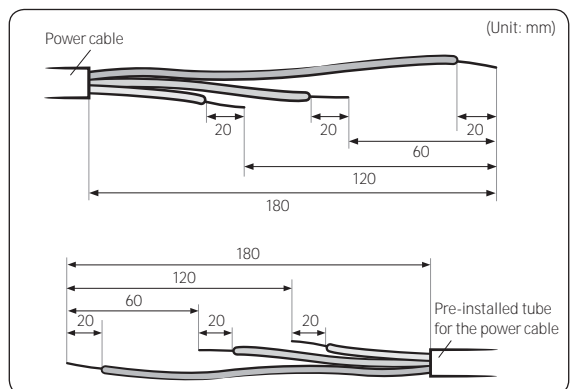

- 3 Insert both sides of core wire of the power cable into the connection sleeve.
- **Method 1:** Push the core wire into the sleeve from both sides.
 - **Method 2:** Twist the wire cores together and push it into the sleeve.

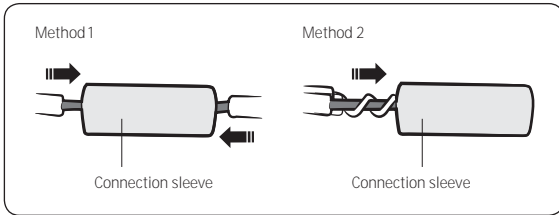

- 4 Using a crimping tool, compress the two points and flip it over and compress another two points in the same location.
- The compression dimension should be 8.0.

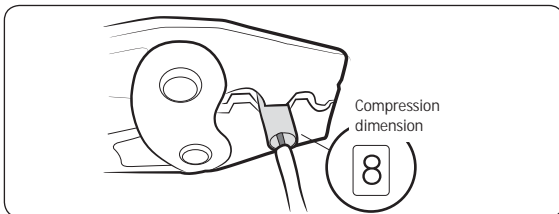

- After compressing it, pull both sides of the wire to make sure it is firmly pressed.

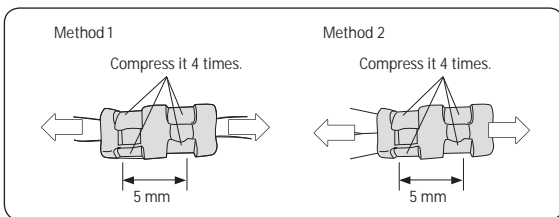

- 5 Wrap it with the insulation tape twice or more and position your contraction tube in the middle of the insulation tape.

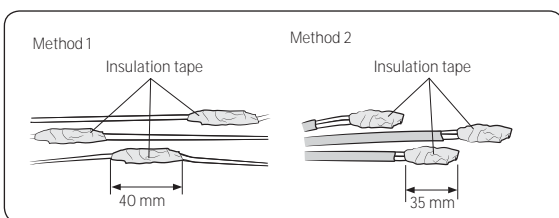

- 6 Apply heat to the contraction tube to contract it.

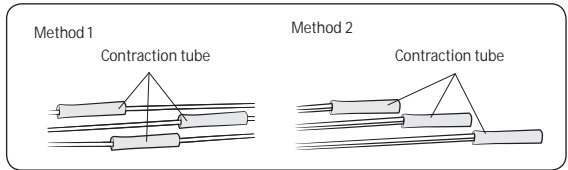

- 7 After tube contraction work is completed, wrap it with the insulation tape to finish. Three or more layers of insulation are required.

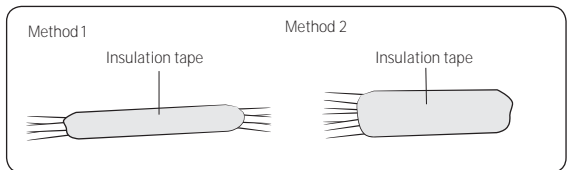

CAUTION

- Make sure that the connection parts are not exposed to outside.
- Be sure to use insulation tape and a contraction tube made of approved reinforced insulating materials that have the same level of withstand voltage with the power cable. (Comply with the local regulations on extensions.)

WARNING

- In case of extending the electric wire, please DO NOT use a round-shaped Pressing socket.
 - Incomplete wire connections can cause electric shock or a fire.

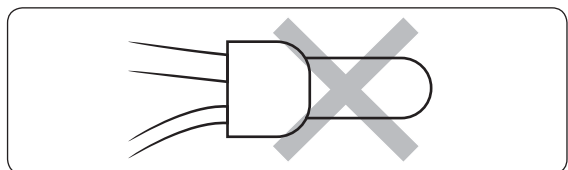

Installation Procedure

Step 14 Setting the indoor unit addresses and the installation options

You cannot set both of the indoor unit addresses and the installation options in a batch: set both of them respectively.

Common steps for setting the addresses and options

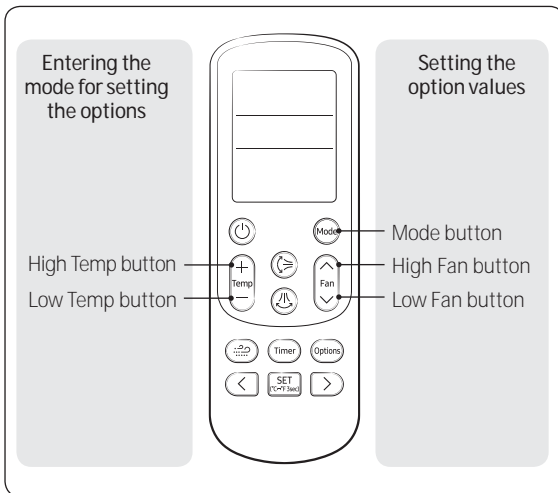

NOTE

- The remote control display and buttons may vary depending on the model.

- Enter the mode for setting the options:
 - Remove the batteries from the remote control, and then insert them again.
 - While holding down the (High Temp) and (Low Temp) buttons simultaneously, insert the batteries into the remote control.
 - Make sure that you are entered to the mode for setting the options:

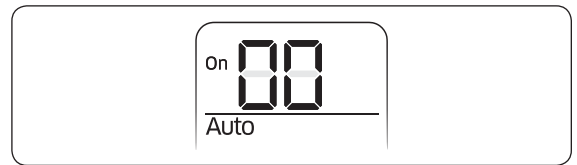

- Set the option values.







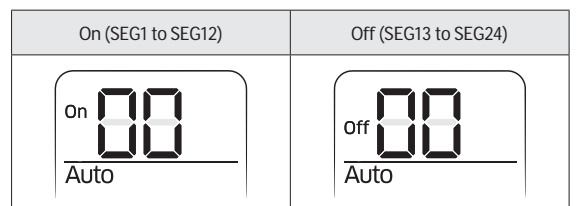





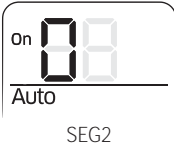
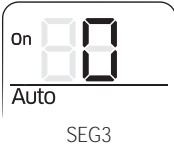

CAUTION

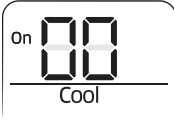
- The total number of available options are 24: SEG1 to SEG24.
- Because SEG1, SEG7, SEG13, and SEG19 are the page options used by the previous remote control models, the modes to set values for these options are skipped automatically.
- Set a 2-digit value for each option pair in the following order: SEG2 and SEG3 → SEG4 and SEG5 → SEG6 and SEG8 → SEG9 and SEG10 → SEG11 and SEG12 → SEG14 and SEG15 → SEG16 and SEG17 → SEG18 and SEG20 → SEG21 and SEG22 → SEG23 and SEG24



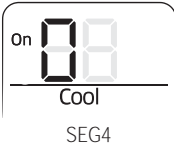
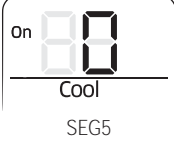

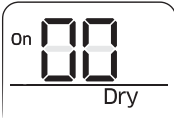

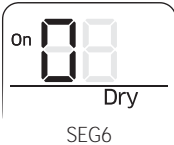
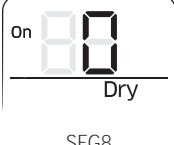









SEG1	SEG2	SEG3	SEG4	SEG5	SEG6
0	X	X	X	X	X
SEG7	SEG8	SEG9	SEG10	SEG11	SEG12
1	X	X	X	X	X
SEG13	SEG14	SEG15	SEG16	SEG17	SEG18
2	X	X	X	X	X
SEG19	SEG20	SEG21	SEG22	SEG23	SEG24
3	X	X	X	X	X

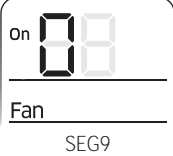
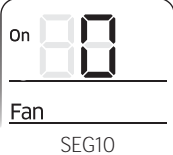

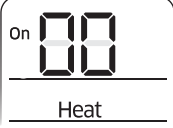



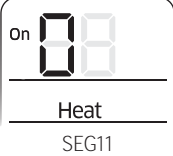
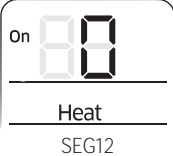



















Take the steps presented in the following table:



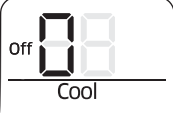
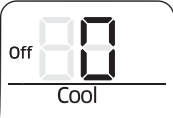



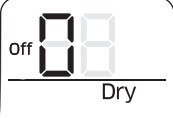
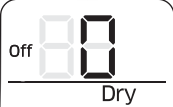







Steps	Remote control display
<p>1 Set the SEG2 and SEG3 values:</p> <p>a Set the SEG2 value by pressing the  (Low Fan) button repeatedly until the value you want to set appears on the remote control display.</p> <p>b Set the SEG3 value by pressing the  (High Fan) button repeatedly until the value you want to set appears on the remote control display.</p> <p>When you press the  (Low Fan) or  (High Fan) button, values appear in the following order: 0 → 1 → ... → E → F</p>	 
<p>2 Press the  (Mode) button. Cool and On appear on the remote control display.</p>	
<p>3 Set the SEG4 and SEG5 values:</p> <p>a Set the SEG4 value by pressing the  (Low Fan) button repeatedly until the value you want to set appears on the remote control display.</p> <p>b Set the SEG5 value by pressing the  (High Fan) button repeatedly until the value you want to set appears on the remote control display.</p> <p>When you press the  (Low Fan) or  (High Fan) button, values appear in the following order: 0 → 1 → ... → E → F</p>	 
<p>4 Press the  (Mode) button. Dry and On appear on the remote control display.</p>	
<p>5 Set the SEG6 and SEG8 values:</p> <p>a Set the SEG6 value by pressing the  (Low Fan) button repeatedly until the value you want to set appears on the remote control display.</p> <p>b Set the SEG8 value by pressing the  (High Fan) button repeatedly until the value you want to set appears on the remote control display.</p>	 

Installation Procedure

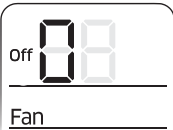
Steps	Remote control display
<p>When you press the  (Low Fan) or  (High Fan) button, values appear in the following order: 0 → 1 → ... E → F</p>	
<p>6 Press the  (Mode) button. Fan and On appear on the remote control display.</p>	
<p>7 Set the SEG9 and SEG10 values:</p> <p>a Set the SEG9 value by pressing the  (Low Fan) button repeatedly until the value you want to set appears on the remote control display.</p> <p>b Set the SEG10 value by pressing the  (High Fan) button repeatedly until the value you want to set appears on the remote control display.</p> <p>When you press the  (Low Fan) or  (High Fan) button, values appear in the following order: 0 → 1 → ... E → F</p>	 
<p>8 Press the  (Mode) button. Heat and On appear on the remote control display.</p>	
<p>9 Set the SEG11 and SEG12 values:</p> <p>a Set the SEG11 value by pressing the  (Low Fan) button repeatedly until the value you want to set appears on the remote control display.</p> <p>b Set the SEG12 value by pressing the  (High Fan) button repeatedly until the value you want to set appears on the remote control display.</p> <p>When you press the  (Low Fan) or  (High Fan) button, values appear in the following order: 0 → 1 → ... E → F</p>	 
<p>10 Press the  (Mode) button. Auto and Off appear on the remote control display.</p>	

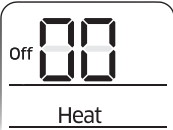

Steps	Remote control display
<p>11 Set the SEG14 and SEG15 values:</p> <p>a Set the SEG14 value by pressing the  (Low Fan) button repeatedly until the value you want to set appears on the remote control display.</p> <p>b Set the SEG15 value by pressing the  (High Fan) button repeatedly until the value you want to set appears on the remote control display.</p> <p>When you press the  (Low Fan) or  (High Fan) button, values appear in the following order:  →  → ...  → </p>	 <p style="text-align: center;">SEG14</p>  <p style="text-align: center;">SEG15</p>
<p>12 Press the  (Mode) button. Cool and Off appear on the remote control display.</p>	
<p>13 Set the SEG16 and SEG17 values:</p> <p>a Set the SEG16 value by pressing the  (Low Fan) button repeatedly until the value you want to set appears on the remote control display.</p> <p>b Set the SEG17 value by pressing the  (High Fan) button repeatedly until the value you want to set appears on the remote control display.</p> <p>When you press the  (Low Fan) or  (High Fan) button, values appear in the following order:  →  → ...  → </p>	 <p style="text-align: center;">SEG16</p>  <p style="text-align: center;">SEG17</p>
<p>14 Press the  (Mode) button. Dry and Off appear on the remote control display.</p>	
<p>15 Set the SEG18 and SEG20 values:</p> <p>a Set the SEG18 value by pressing the  (Low Fan) button repeatedly until the value you want to set appears on the remote control display.</p> <p>b Set the SEG20 value by pressing the  (High Fan) button repeatedly until the value you want to set appears on the remote control display.</p>	 <p style="text-align: center;">SEG18</p>  <p style="text-align: center;">SEG20</p>

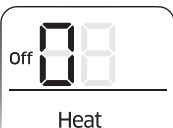
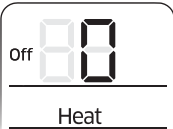
Installation Procedure

Steps	Remote control display
<p>When you press the  (Low Fan) or  (High Fan) button, values appear in the following order: 0 → 1 → ... E → F</p>	<p>SEG20</p>
<p>16 Press the  (Mode) button. Fan and Off appear on the remote control display.</p>	
<p>17 Set the SEG21 and SEG22 values:</p> <p>a Set the SEG21 value by pressing the  (Low Fan) button repeatedly until the value you want to set appears on the remote control display.</p> <p>b Set the SEG22 value by pressing the  (High Fan) button repeatedly until the value you want to set appears on the remote control display.</p> <p>When you press the  (Low Fan) or  (High Fan) button, values appear in the following order: 0 → 1 → ... E → F</p>	 <p>SEG21</p>  <p>SEG22</p>
<p>18 Press the  (Mode) button. Heat and Off appear on the remote control display.</p>	
<p>19 Set the SEG23 and SEG24 values:</p> <p>a Set the SEG23 value by pressing the  (Low Fan) button repeatedly until the value you want to set appears on the remote control display.</p> <p>b Set the SEG24 value by pressing the  (High Fan) button repeatedly until the value you want to set appears on the remote control display.</p> <p>When you press the  (Low Fan) or  (High Fan) button, values appear in the following order: 0 → 1 → ... E → F</p>	 <p>SEG23</p>  <p>SEG24</p>

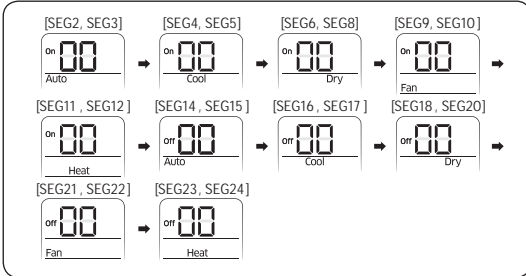
- 3 Check whether the option values that you have set are correct by pressing the  (Mode) button repeatedly



- 4 Save the option values into the indoor unit:
Point the remote control to the remote control sensor on the indoor unit and then press the  (Power) button on the remote control twice. Make sure that this command is received by the indoor unit. When it is successfully received, you can hear a short sound from the indoor unit. If the command is not received, press the  (Power) button again.
- 5 Check whether the air conditioner operates in accordance with the option values you have set:
- Reset the indoor unit by disconnecting and then reconnecting the power cable of the indoor unit or by pressing the RESET button on the outdoor unit.
 - Remove the batteries from the remote control, insert them again, and then press the  (Power) button on the remote control.

Setting the indoor unit address and installation option

- Make sure that the power is supplied to the indoor unit.
 - If the indoor unit is not plugged in, it must include a power supply.
- Make sure that the panel or display is connected to the indoor unit so that it can receive options

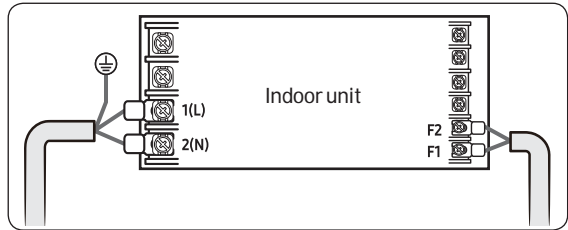

- Set an address and installation option for each indoor unit using the remote control, according to your air conditioning system plan.

Installation Procedure

Setting an indoor unit address (MAIN/RMC)

- The indoor unit address are set to 0A0000-100000-200000-300000 by default.

Option No. : 0AXXXX-1XXXXX-2XXXXX-3XXXXX

Option	SEG1		SEG2		SEG3		SEG4		SEG5		SEG6	
Explanation	Page		Mode		Setting main address		100-digit of indoor unit address		10-digit of indoor unit		A single digit of indoor unit	
Indication and details	Indication	Details	Indication	Details	Indication	Details	Indication	Details	Indication	Details	Indication	Details
	0		A		0	No Main address	0-9	100-digit	0-9	10-digit	0-9	A single digit
					1	Main address setting mode						
Option	SEG7		SEG8		SEG9		SEG10		SEG11		SEG12	
Explanation	PAGE		Reserved		Setting RMC address		Reserved		Group channel(*16)		Group address	
Indication and Details	Indication	Details			Indication	Details			Indication	Details	Indication	Details
	1				0	No RMC address			RMC1	1-F	RMC2	1-F
			1	RMC address setting mode								

* You must set RMC address setting mode when using the centralized Control.

CAUTION

- When "A"~"F" is entered to SEG4~6, the indoor unit MAIN ADDRESS is not changed.
- If you set the SEG 3 as 0, the indoor unit will maintain the previous MAIN ADDRESS even if you input the option value of SEG4~6.
- If you set the SEG 9 as 0, the indoor unit will maintain previous RMC ADDRESS even if you input the option value of SEG11~12.

Setting an indoor unit installation option (suitable for the condition of each installation location)

- The indoor unit installation option are set to 020000-100000-200000-300000 by default.
- Set the indoor unit option by wireless remote controller. When entering Address option, connect remote controller receiver.

Installation options

SEG1	SEG2	SEG3	SEG4	SEG5	SEG6
0	2	Reserved	Use of external room temperature sensor / Minimizing fan operation when thermostat is off	Use of central control	Compensation of the fan RPM
SEG7	SEG8	SEG9	SEG10	SEG11	SEG12
1	Using of drain pump	Reserved	Reserved	Reserved	Dew removal operation in Wind-Free mode
SEG13	SEG14	SEG15	SEG16	SEG17	SEG18
2	Use of external control	Setting the output of external control	Ionizer	Buzzer Control	Hours of filter usage
SEG19	SEG20	SEG21	SEG22	SEG23	SEG24
3	Individual control with remote control	Heating setting compensation offset	Reserved	Reserved	Cycle time of Swing

- Even if you set the Use of drain pump (SEG8) option to 0, it is automatically set to 2 (the drain pump is used with 3 minute delay).
- If you set the Maximum filter usage time (SEG18) option to a value other than 2 and 6, it is automatically set to 2 (1000 hours).
- If you set an option to a value that is out of range specified above, the option is automatically set to 0 by default.
- The external output of SEG15 is generated via MIM-B14 connection. (Refer to the manual of MIM-B14.)
- If you set the Individual control with remote control (SEG20) option to a value other than 0 to 4, it is automatically set to 0 (Indoor1).

Installation Procedure

Installation option (Detailed)

Option No. : 02XXXX-1XXXX-2XXXX-3XXXX

Option	SEG1		SEG2		SEG3	SEG4		SEG5		SEG6			
Function	Page		Mode		Reserved	Use of external room temperature sensor / Minimizing fan operation when thermostat is off		Use of central control		Compensation of the fan RPM			
Indication and details	Indication	Details	Indication	Details		Indication	Details		Indication	Details	Indication	Details	
	0		2				Use of External room temperature sensor	Minimizing fan operation when thermostat is off	0	Disuse	0	Disuse (recessed installation)	
							0	Default					Default
							1	Use					Disuse
							2	Disuse					Use (Heating)
							3	Use					Use (Heating)
							4	Disuse					Use (Cooling)
							5	Use					Use (Cooling)
							6	Disuse					Use (Heating / Cooling)
							7	Use					Use (Heating / Cooling)
							8	Disuse					Use (Cooling Ultra Low Fan)
					9		Use	Use (Cooling Ultra Low Fan)					
A					Disuse	Use (Heating / Cooling Ultra Low Fan)							
B	Use	Use (Heating / Cooling Ultra Low Fan)											
Option	SEG7		SEG8		SEG9	SEG10		SEG11		SEG12			
Function	Page		Use of drain pump		Reserved	Reserved		Reserved		Dew removal operation in Wind-free mode			
Indication and details	Indication	Details	Indication	Details						Indication	Details		
	1		0	Disuse						0	Maintain blade status in Wind-Free mode		
			1	Use									
			2	Use with 3 minute delay	1	(Default) Cooling operation by opening the blade							

Installation Procedure

Option	SEG13		SEG14			SEG15		SEG16		SEG17		SEG18									
Function	Page		Use of external control			Setting the output of external control		Ionizer		Buzzer control		Maximum filter usage time									
Indication and details	Indication	Details	Indication	Details		Indication	Details	Indication	Details	Indication	Details	Indication	Details								
			0	Disuse	Slave, Existing Control									0	Thermo on	0	Disuse	0	Use of buzzer	2	1000 hours
	1	On/Off																			
	2	Off																			
	3	Window																			
	4	Disuse	Master, Existing Control																		
	5	On/Off																			
	6	Off																			
	7	Window																			
	8	Disuse	Slave, Existing Control	1	Operation on	1	Use	1	Disuse of buzzer	6	2000 hours										
	9	On/Off																			
	A	Off																			
	B	Window																			
	C	Disuse	Master, Existing Control																		
	D	On/Off																			
E	Off																				
F	Window																				
Option	SEG19		SEG20									SEG21		SEG22		SEG23		SEG24			
Function	Page		Individual control with remote control									Heating setting compensation		Reserved		Reserved		Cycle time of Swing			
Indication and details	Indication	Details	Indication									Details						Indication	Details	Indication	Details
			0 or 1									Indoor 1		0	Default	0	34 seconds (default)				
	2	Indoor 2										1	2°C	1	30 seconds						
	3	Indoor 3										2	5°C	2	38 seconds						
	4	Indoor 4																			

- By SEG4 setting, Minimizing fan operation when thermostat is off.
 - Fan operates for 20 seconds at an interval of 5 minutes in Heat mode.
 - Fan stops or operates Ultra low in Cooling when thermostat is off.
- Even if you set the Use of drain pump (SEG8) option to 0, it is automatically set to 2 (the drain pump is used with 3 minute delay).
- If you set the Maximum filter usage time (SEG18) option to a value other than 2 and 6, it is automatically set to 2 (1000 hours).
- If you set the Individual control with remote control (SEG20) option to a value other than 0 to 4, it is automatically set to 0 (Indoor 1).
- Default value of Heating setting compensation (SEG21) is 2°C.

Installation Procedure

Changing the addresses and options individually

When you want to change the value of a specific option, refer to the following table and follow the steps in **Common steps for setting the addresses and options** on page 20.

Option	SEG1		SEG2		SEG3		SEG4		SEG5		SEG6	
Function	Page		Mode		Type of the option to change		Tens position of the option number		Units position of the option number		New value	
Indication and details	Indication	Details	Indication	Details	Indication	Details	Indication	Details	Indication	Details	Indication	Details
		0		D		Option type	0 to F	Tens position value	0 to 9	Units position value	0 to 9	New value

Example: Changing the Buzzer control (SEG17) option of the installation options to 1 disuse.

Option	SEG1		SEG2		SEG3		SEG4		SEG5		SEG6	
Function	Page		Mode		Type of the option to change		Tens position of the option number		Units position of the option number		New value	
Indication	0		D		2		1		7		1	

CAUTION

- If your indoor units support both cooling and heating, the mixed operation (two or more indoor units operate in different modes simultaneously) is not available when the indoor units are connected to the same outdoor unit. If you set an indoor unit as the master indoor unit by using the remote control, the outdoor unit automatically operate in the current mode of the master indoor unit.

















Appendix

Troubleshooting





Detection of errors

- If an error occurs during the operation, an LED flickers and the operation is stopped except the LED.
- If you re-operate the air conditioner, it operates normally at first, then detect an error again.

LED Display on the receiver & display unit

Abnormal condition	Error code	Indoor unit display indications				
						
		Ice Blue	Yellow Green			
Power reset	-		X	X	X	X
Error on indoor temperature sensor (Short or Open)	E121	X	X		X	X
Error on Eva-in sensor (Short or Open)	E122		X		X	X
Error on Eva-out sensor (Short or Open)	E123					
Indoor fan error	E154	X	X	X		X
Error on outdoor temperature sensor (Short or Open)	E221					
Error on cond sensor	E237		X	X		X
Error on discharge sensor	E251					
When there is no communication between the indoor-outdoor units for 2 minutes	E101					
Communication error received from the outdoor unit	E102					
3 minute tracking error on outdoor unit	E202	X	X			X
Communication error after tracking due to unmatching number of installed units	E201					
Error due to repeated communication address	E108					
Self diagnosis error display						
Error due to opened EEV (2nd detection)	E151					
Error due to closed EEV (2nd detection)	E152					
Eva in sensor is detached	E128	X	X			
Eva out sensor is detached	E129					
Thermal fuse error (Open)	E198					

Appendix

Abnormal condition	Error code	Indoor unit display indications				
						
		Ice Blue	Yellow Green			
COND mid sensor is detached	E241					
Refrigerant leakage (2nd detection)	E554					
Abnormally high temperature on Cond (2nd detection)	E450					
Low pressure s/w (2nd detection)	E451					
Abnormally high temperature on discharged air on outdoor unit (2nd detection)	E416					
Indoor operation stop due to unconfirmed error on outdoor unit	E559					
Error due to reverse phase detection	E425					
Comp stop due to freeze detection (6th detection)	E403					
High pressure sensor is detached	E301	X	X	●	●	●
Low pressure sensor is detached	E306					
Outdoor unit copression ration error	E428					
Compressor down due to low pressure sensor prevention control_1	E410					
Simultaneous opening of cooling/heating MCU SOL valve (1st detection)	E180					
Simultaneous opening of cooling/heating MCU SOL valve (2nd detection)	E181					
Other outdoor unit self-diagnosis error that is not on the above list	-					
Flowating s/w (2nd detection)	E153	X	X	X	●	●
Error of mixed operation	E161	X	●	X	●	X
EEPROM error	E162	●	●	●	●	●
EEPROM option error	E163	●	●	●	●	●

● : On, ◐ : Blinking, X : Off

- If you turn off the air conditioner when the LED is flickering, the LED is also turned off.
- If you re-operate the air conditioner, it operates normally at first, then detect an error again.
- When E108 error occurs, change the address and reset the system.
Ex.) When address of the indoor unit #1 and #2 are set as 5, address of the indoor unit #1 will become 5 and indoor unit #2 will display E108, A002.

Memo

SAMSUNG