

SAMSUNG

SYSTEM AIR CONDITIONER

SINGLE for Europe (R32, Heat Pump)

INDOOR UNIT

OUTDOOR UNIT

Model :	AC026RN1DKG	AC052RNLDKG	AC026RXADKG
	AC035RN1DKG	AC071RNLDKG	AC035RXADKG
	AC026RNNDKG	AC035RNMDKG	AC052RXADKG
	AC035RNNDKG	AC052RNMDKG	AC071RXADKG
	AC052RNNDKG	AC071RNMDKG	
	AC071RNNDKG	AC026RNADKG	
	AC052RN4DKG	AC035RNADKG	
	AC071RN4DKG	AC052RNADKG	
	AC071RN4PKG	AC071RNADKG	
	AC026RNLDKG	AC052RNCDKG	
	AC035RNLDKG	AC071RNCDKG	

SERVICE *Manual*

AIR CONDITIONER



CONTENTS

1. Precautions
2. Product Specifications
3. Disassembly and Reassembly
4. Troubleshooting
5. PCB Diagram
6. Wiring Diagram
7. Reference Sheet

Contents

1. Precautions	1-1
1-1 Precautions for the Service.....	1-1
1-2 Precautions related to static electricity and PL	1-1
1-3 Precautions related to product safety.....	1-2
1-4 Other precautions	1-2
2. Product Specifications	2-1
2-1 CAC Single	2-1
2-2 The Feature of Product.....	2-2
2-2-1 Features (Wind-Free 1Way CST)	2-2
2-3 The Feature of Product	2-3
2-3-1 Features (Wind-Free 4Way CST).....	2-3
2-4 Features & Benefits.....	2-8
2-4-1 4Way Cassette (600 x 600).....	2-8
2-4-2 4Way Cassette (600 x 600)-Tasteful design, Compact, Lightweight build	2-8
2-4-3 360 Cassette.....	2-10
2-4-4 Slim Duct - Ultra-light, adaptable design.....	2-12
2-4-5 Duct S.....	2-14
2-4-6 Ceiling Type - Slim yet functional design.....	2-15
2-4-7 Wall Mount Type.....	2-16
2-4-8 AR9000, 7000, 5000 Series - Triangular design, powerful cooling	2-17
2-5 Product Specifications.....	2-18
2-6 Specifications of optional items	2-26
2-6-1 Accessories.....	2-26
3. Disassembly and Reassembly.....	3-1
3-1 Indoor unit.....	3-2
3-2 Outdoor unit	3-64
4. Troubleshooting	4-1
4-1 Setting an indoor unit address and installation option	4-1
4-1-1 The procedure of setting option.....	4-1
4-1-2 The procedure of setting option	4-2
4-1-3 Order for Setting Options	4-5
4-1-4 Setting an indoor unit installation option	4-6
4-1-5 Changing a particular option	4-8
4-1-6 Option code for each model	4-9
4-2 Items to check before diagnostics.....	4-10
4-2-1 Test run mode and View mode	4-10
4-2-2 Eco Mode [Power Saving Mode]	4-13
4-2-3 Four directions cassette type	4-14
4-2-4 Outdoor Unit.....	4-16
4-2-5 Wired remote controller	4-18
4-3 Troubleshooting by symptoms.....	4-21
4-3-1 Indoor temperature sensor (open/short).....	4-21
4-3-2 Indoor heat exchanger temperature sensor (open/short).....	4-22

Contents

4-3-3 Indoor FAN error.....	4-23
4-3-4 Communication error after finishing Tracking.....	4-24
4-3-5 Indoor unit float sensor error	4-25
4-3-6 EEPROM circuit failure.....	4-26
4-3-7 E407.....	4-27
4-3-8 When the outdoor unit power is not ON	
- Initial Diagnosis : 3-phase products	4-28
4-3-9 Indoor/outdoor communication error (1min.) (Error Code : E202).....	4-32
4-3-10 Communication error between outdoor unit INV ↔ MAIN MICOM (1 min.) (Error Code: E203).....	4-34
4-3-11 Outdoor sensor error (Error Code : E221, E231, E251, E320)	4-35
4-3-12 Reverse phase / Loss phase detection (3-phase outdoor unit) (Error Code : E425)	4-36
4-3-13 Compressor down due to freezing control (Error Code : E403)	4-37
4-3-14 Outdoor unit Fan error (Error Code : E458, E475).....	4-38
4-3-15 Compressor starting error / rotation error (Error Code : E461, E467)....	4-39
4-3-16 Full current error / PFC over-current error (Error Code : E462, E484)....	4-41
4-3-17 IPM over current error (Error Code : E464).....	4-42
4-3-18 DC LINK over-current / low-voltage error (Error Code : E466) H/W DC_Link Over Voltage Error (Error Code : E483) AC Input Voltage Sensor Error (Error Code : E488)	4-45
4-3-19 Gas leakage error (Error Code : E554).....	4-46
4-3-20 Pipe blockage error (Error Code : E422).....	4-48
4-3-21 Smart install mode was not carried out (Error Code : E508).....	4-49
4-3-22 Others	4-51
5. PCB Diagram and Parts List.....	5-1
5-1 Indoor Unit	5-1
5-1-1 MAIN PCB.....	5-1
5-1-2 Display PCB.....	5-11
5-1-3 Sub PCB.....	5-14
5-1-4 BLDC PBA	5-15
5-2 Outdoor Unit.....	5-16
5-2-1 MAIN PCB.....	5-16
5-2-2 INVERTER PCB.....	5-18
6. Wiring Diagram	6-1
6-1 Indoor Unit	6-1
6-2 Outdoor unit	6-9
7. Reference Sheet	7-1
7-1 Index for Model Name	7-1
7-1-1 Indoor Unit	7-1
7-1-2 Outdoor Unit.....	7-2
7-1-3 Panel	7-3
7-2 Refrigerating Cycle Diagram.....	7-4

1. Precautions

1-1 Precautions for the Service

- **Use the standard parts when replacing the electric parts.**
 - Confirm the model name, rated voltage, rated current of the electric parts.
- **When repairing the equipment, connection of the harness parts must be firm and solid.**
 - A loose connection may cause noise or other malfunction.
- **When assembling and disassembling the equipment while it is laid down, lay it on soft cloth.**
 - Otherwise it may scratch the back of the exterior of the product.
- **Remove dust or dirt completely from the housing block, wiring block and service parts during repair.**
 - This helps prevent the danger of fire caused by tracking or short circuit.
- **Fasten the valve caps of service valves and charging valves of outdoor unit as much as possible using adjustable wrenches.**
- **Check the status of the components' assembly after repair service.**
 - The status must be the same as before the repair service.

1-2 Precautions related to static electricity and PL

- **The PCB power supply block is susceptible to static electricity.**
Therefore, care must be taken during repair or measuring while the power is on.
 - Wear insulation gloves for PCB repair or measuring.
- **Check whether the installation location is at least two meters away from other electronic products such as TV, video, or audio.**
 - Otherwise, the video quality might be degraded or noise might be generated.
- **Do not let end users repair the products themselves.**
 - Unauthorized disassembly might cause electric shock or fire.

1-3 Precautions related to product safety

- **Do not pull the power cord and do not touch the power plug or aux power switch with wet hands.**
 - It might cause electric shock or fire.
- **A damaged power line or power plug must be replaced to prevent danger.**
- **Do not bend the power cable with excessive force, and do not place a heavy weight on the case as it might damage the cable.**
 - It might cause electric shock or fire.
- **Do not use multiple electric outlets.**
 - This might cause electric shock or fire.
- **Connect the ground terminal when necessary.**
 - You must connect the ground terminal if you determine that there is a danger of electric leakage due to moisture or water.
- **Unplug the power cable or turn off the auxiliary power switch for electric part replacement and repair service.**
 - Otherwise it might cause electric shock.
- **Instruct end users to separate the batteries from the remote controllers and store them separately when the product is not used for long time.**
 - Otherwise leakage from the dry cell may cause problems with the remote controller.

1-4 Other precautions

- **The pipes should have no leaks during installation, and the compressor must be stopped before removing connecting pipes for pump down work. Operating the compressor while the service valve is open and refrigerant pipe is not properly connected may cause explosion or injury due to abnormal high pressure created inside the refrigerant cycle as the air can be absorbed through the pipe.**
- **Pump Down work procedure (When uninstalling the product)**
 - Turn on the air conditioner, select cooling operation, and run the compressor for more than three minutes.
 - Release the high pressure and low pressure valve caps.
 - Close the high pressure valve completely using an L-wrench.
 - After about two minutes, close the low pressure valve completely.
 - Stop running the air conditioner.
 - Separate the connecting pipe.

2. Product Specifications

2-1 CAC Single

■ Stabilize the atmosphere with broad temperature allowance and control

Samsung is dedicated to supporting comfortable living and working environments based on the strength of its technologies. With a single unit, CAC Single delivers reliable comfort and control over multiple areas to ensure a pleasant atmosphere in any climate.

■ Wide temperature performance

No matter how extreme the temperature, the highperforming CAC Single can handle the condition without the need for an additional unit. Featuring a wide temperature allowance, it can cool in heat of up to 50 and provide warmth in the freezing cold of -20°C to ensure a constant and comfortable home environment.

■ Ideal comfort in minutes

The CAC Single digital inverter air conditioner works at maximum capacity at startup. As soon as the temperature reaches the desired or set temperature, CAC Single performs fine adjustments to cope with any changes. This means less temperature fluctuation and ideal comfort in a matter of minutes.

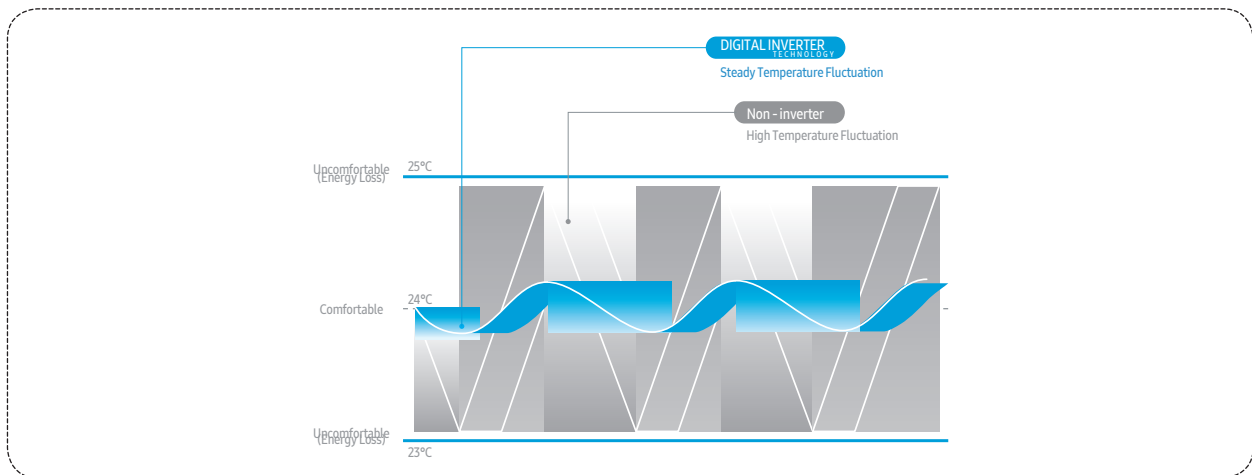

■ Versatile piping installation

CAC Single outdoor units offer a selection of pipe directions. The internal pipe connection ports allow four different pipe directions, supporting a neater, more organized-looking unit upon installation.



2-2 The Feature of Product

2-2-1 Features (Wind-Free 1Way CST)

■ Wind-Free cooling

Comfort wind implementation by Wind-Free cooling.

※ Wind-Free implementation : Still air by the velocity of flow below 0.15m/s.

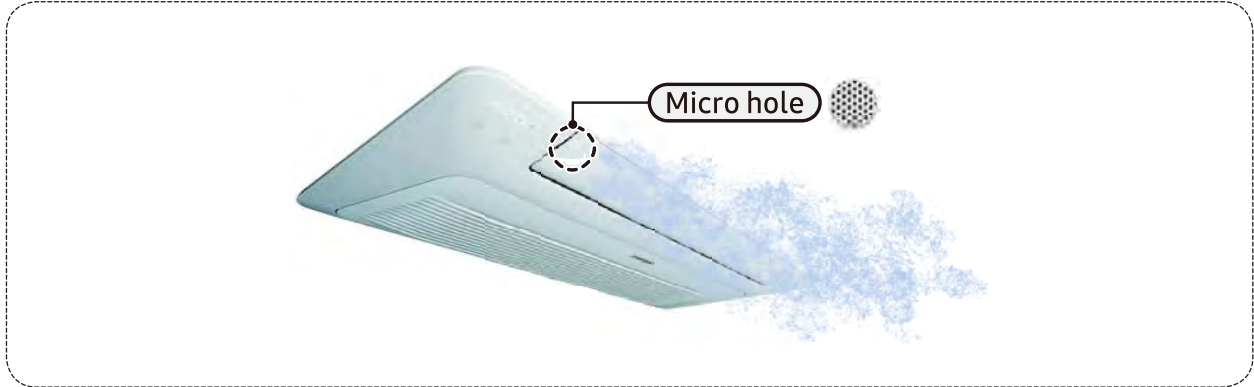

■ Big blade

Max. 8m Horizontal reach

※ Blade enlargement about 47% compare to conventional product

※ Reach : 8m (Height 0.6m, Wind speed 0.3m/s) Conventional product (Samsung) : 5m

※ Based on Wind-Free 1Way 7.1kW

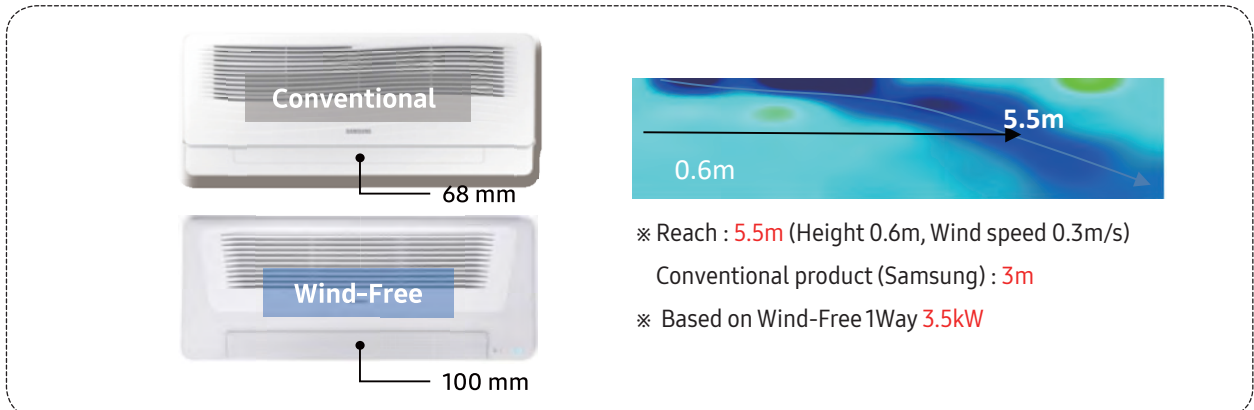

■ Even cooling

Even cooling For spacious space

※ Expand the blade angle from 30° to 80°

Conventional product (Samsung) : 40~80°

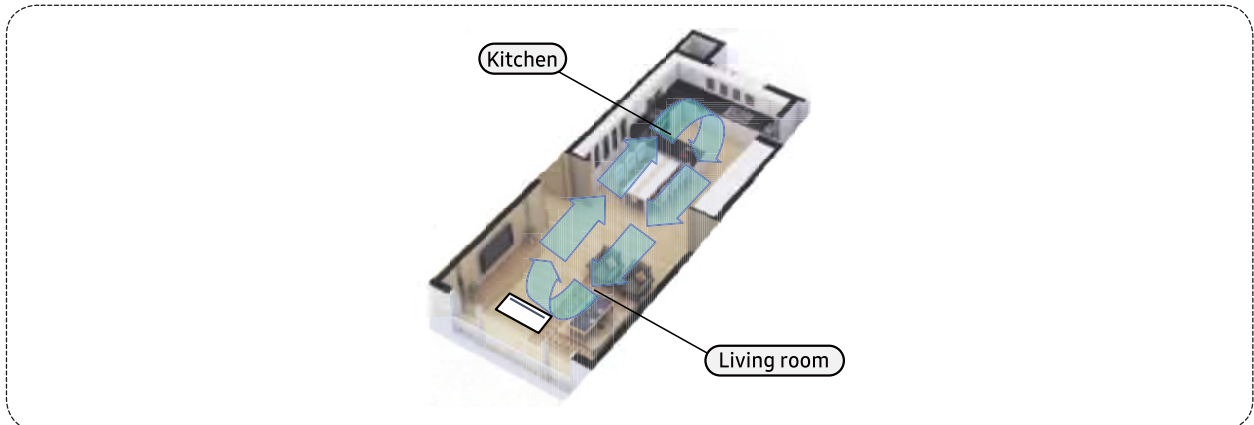

2-3 The Feature of Product

2-3-1 Features (Wind-Free 4Way CST)

■ Wind-Free Cooling with Micro holes

The Wind Free Air conditioner pushes air out through 15,000 micro holes in the panel, producing a dispersed and gentle flow of air actually defined as “still air” and the key here is all of those holes create a still, cooled air flow that infiltrates the room gently and softly.

No Direct Wind & Cold Draft

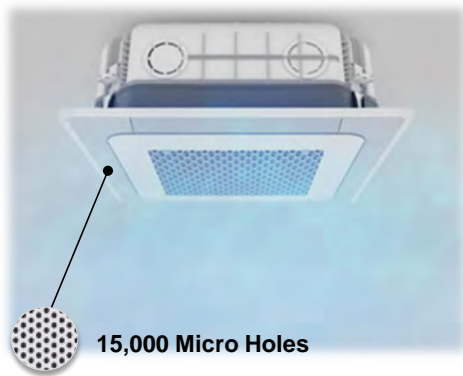

[Comparison of Room Temp.]

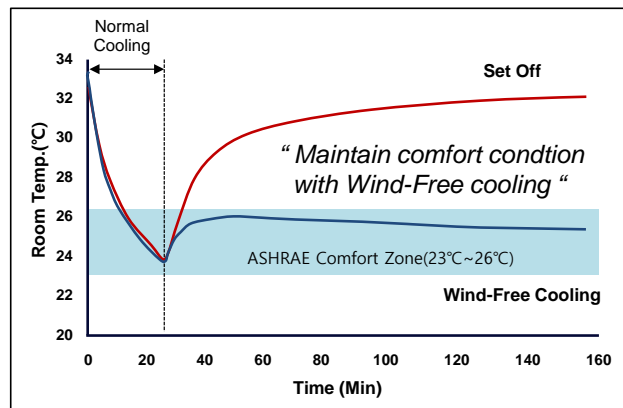

■ Wind-Free Cooling with Micro holes

Quiet Operation

“Extremely quiet with Wind-Free Operation”
⇒ Suitable for office, school, library.....

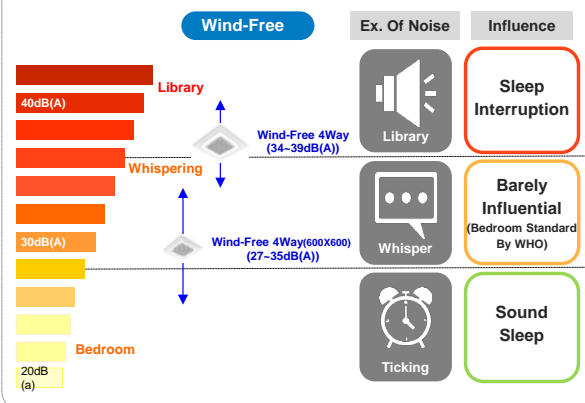

Cost, Energy Saver

“Energy Saving with Wind-Free Operation”

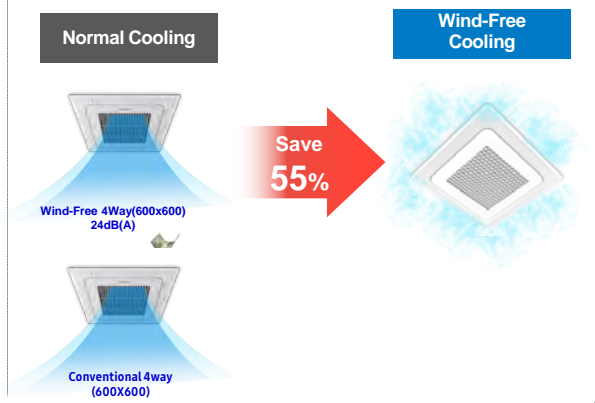

Features (Wind-Free 4Way CST) (cont.)

- **Big Blade, Long Wind**
Big and optimized blades enable wider cooling range.

Wider Cooling Range

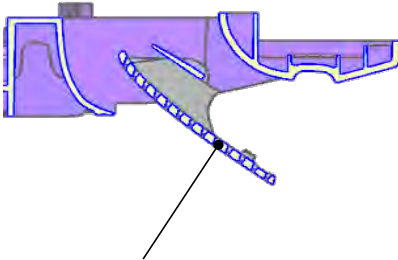

81mm Big Blade (26% ↑)
Optimized Blade Shape

Wind-Free 4Way

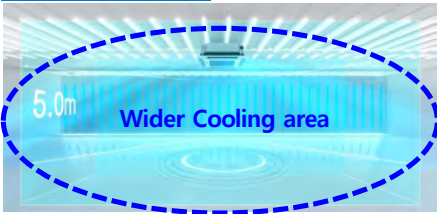

5.0m
Wider Cooling area

Conventional 4Way

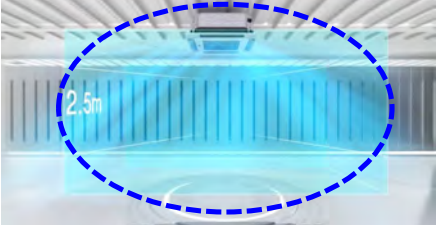

2.5m

- **Smart Comfort Operation**
Smart comfort operation enable to maintain optimal room condition automatically by detecting not only temperature but also relative humidity.

Automatic Wind-Free Operation

If room reaches comfort zone

If room get out of comfort zone



Normal Cooling

Wind-Free Cooling

Normal Cooling

Features (Wind-Free 4Way CST) (cont.)

■ New MDS operation (Option)

New designed Motion Detect enable customized air direction and efficient operation by detecting the location of people.

Automatic MDS Operation
(Option)

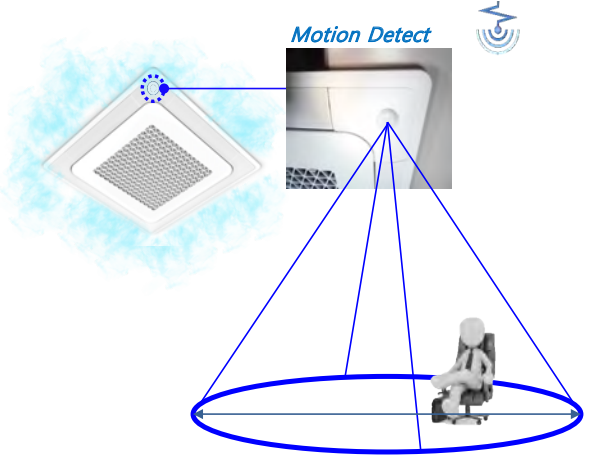

※ MDS : Motion Detect Sensor

1. Wind Direction

"Direct wind or Indirect wind"



Direct wind



Indirect wind

Choose your comfort

2. Energy Saving

"Wind-Free + OFF Control"

35%→50%
Energy saving

Power Input

Cooling 120mins 30mins 50mins Stop

Conventional Saving 35%

■ World's Lightest Weight

Advanced Features

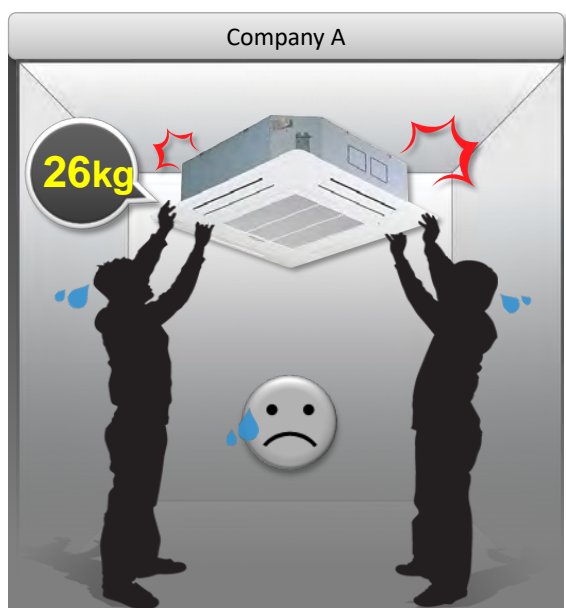

Features (Wind-Free 4Way CST) (cont.)

■ **Easy Installation in 4 Different Ways**

Freely install anywhere without worrying about direction. (Body and Panel as well)

Advanced Features

No Limitation of direction (Both Body & Panel)

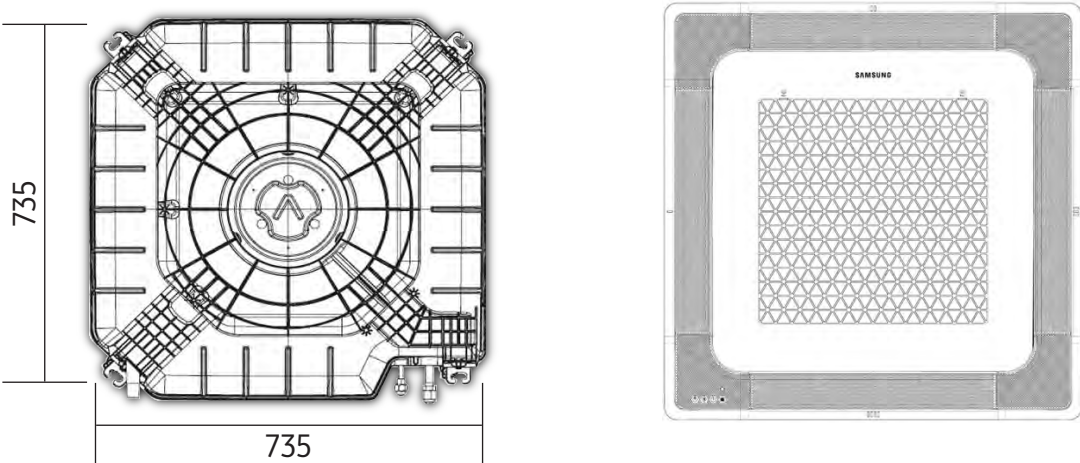

■ **New Improved Design**

Advanced Features

New Stylish and Aesthetic Panel



Simple Display

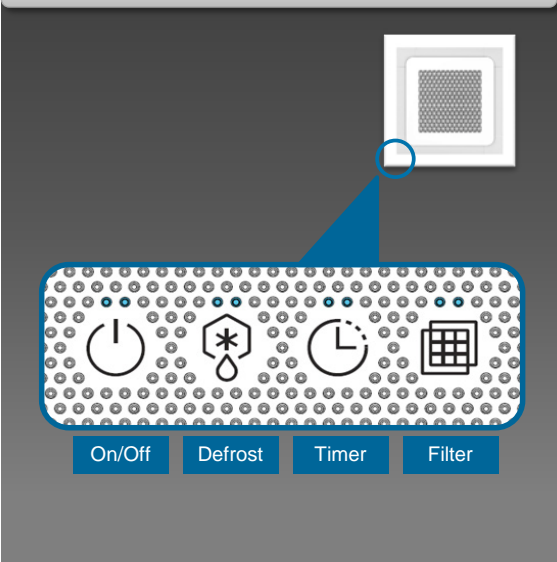

Features (Wind-Free 4Way CST) (cont.)

■ ENo Back Flowing Drain Water

Check Valve on the drain pump prevents drain water from reversing
 → Minimize water gathering in Drain Board to prevent rusting

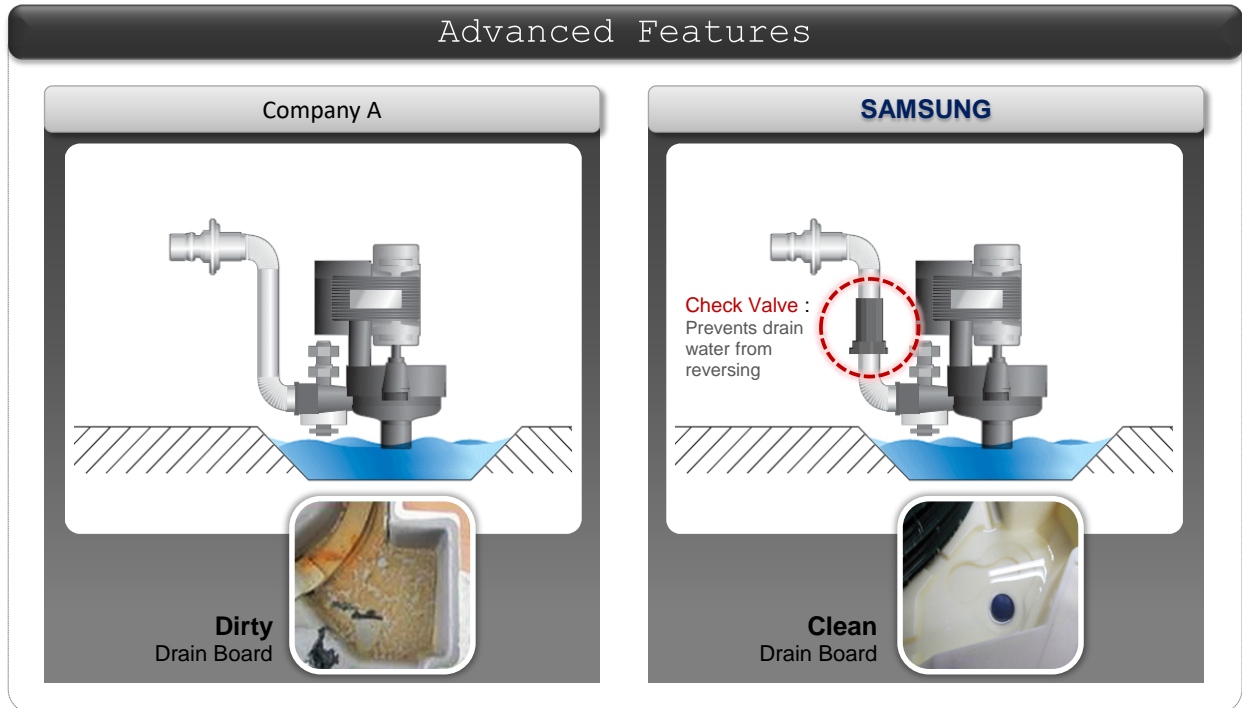

■ Easy Maintenance

Easy Air Flow Blade Cleaning

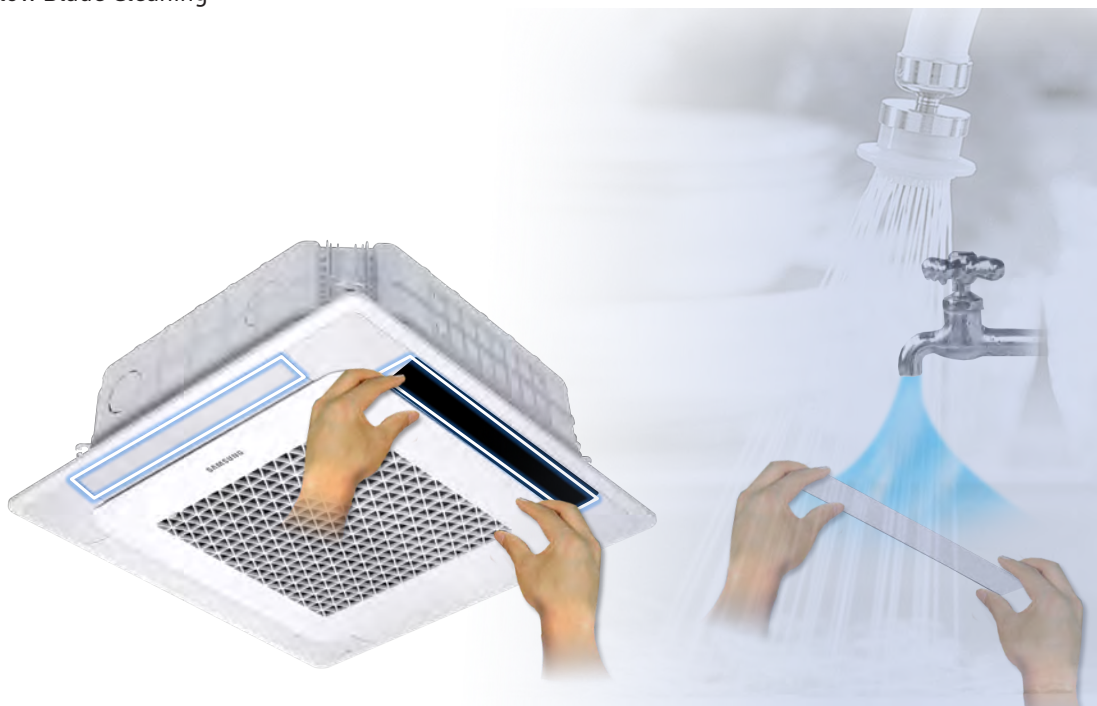

2-4 Features & Benefits

2-4-1 4Way Cassette (600 x 600)

■ Add chic flair to your interior design with a stylish yet powerful AC system

Samsung's advanced 4Way Cassette (600 x 600) builds on the aesthetic appeal and performance of the standard 4Way Cassette with an enhanced design. The 4Way Cassette (600 x 600) comes in a variety of patterns to complement any interior. The stylish cassette unit visually harmonizes with the indoor space, while efficient cooling and heating performance make it a dependable and practical air conditioning solution. The 4Way Cassette (600 x 600) indoor air conditioning system provides high-performance heating and cooling in an elegant design with features such as:

- **Tasteful design and compact, lightweight build.**
Create a polished ambiance with a discreetly sized design and a choice of attractive panel patterns.
- **Enhanced comfort control.**
Optimize comfort and save energy with optional motion detection.
- **Low maintenance and powerful airflow.**
Ease installation and maintenance and maximize airflow with an efficient design and robust performance.

2-4-2 4Way Cassette (600 x 600) - Tasteful design, Compact, Lightweight build

■ Refine the interior with an elegant, compact design

The enhanced Samsung 4Way Cassette (600 x 600) indoor air conditioner features a selection of simple panel patterns to blend seamlessly into any interior design. Its uniquely lightweight frame blends effortlessly and beautifully into any décor, while clever blade construction keeps the unit clean for a tidy appearance.

■ Attractive panel and display

The 4Way Cassette (600 x 600) features a fashionable panel with a simple, beveled corner design. The rounded panel frame promotes a neat, tidy look for an aesthetic flair that blends perfectly with any ambience.

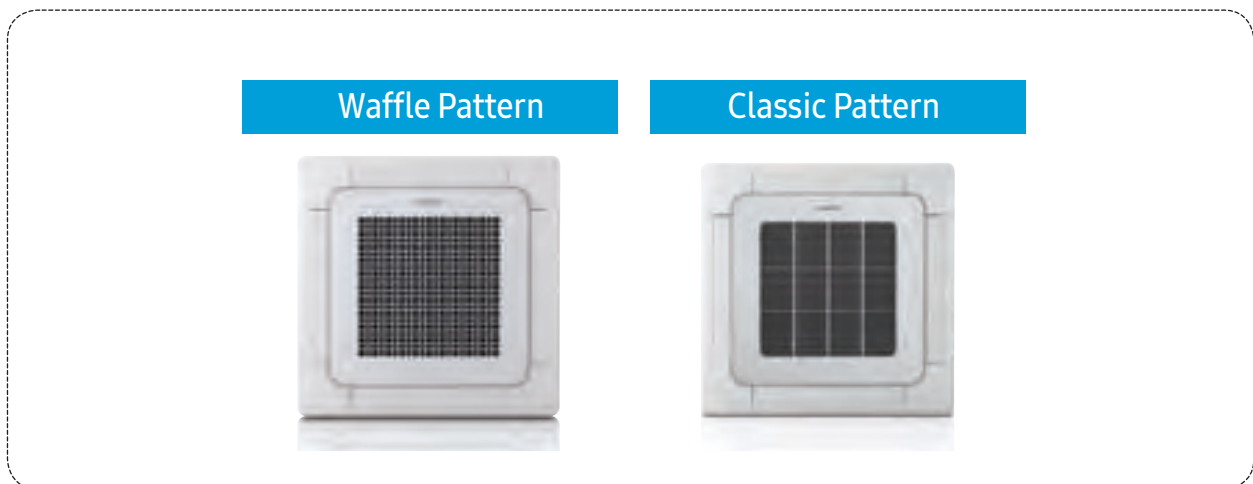

■ **Ultra-compact size**

Samsung's 4Way Cassette (600 x 600) air conditioner can be installed on a single standard ceiling tile (600W x 600D) which helps minimize installation time and effort.

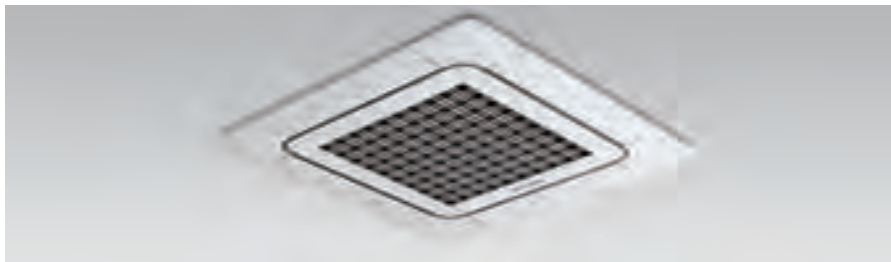

■ **Light, robust design**

The Samsung 4Way Cassette (600 x 600) indoor unit is now lighter in weight at 11kg. It is the lightest indoor unit in the industry, about 35 percent lighter than our conventional products.

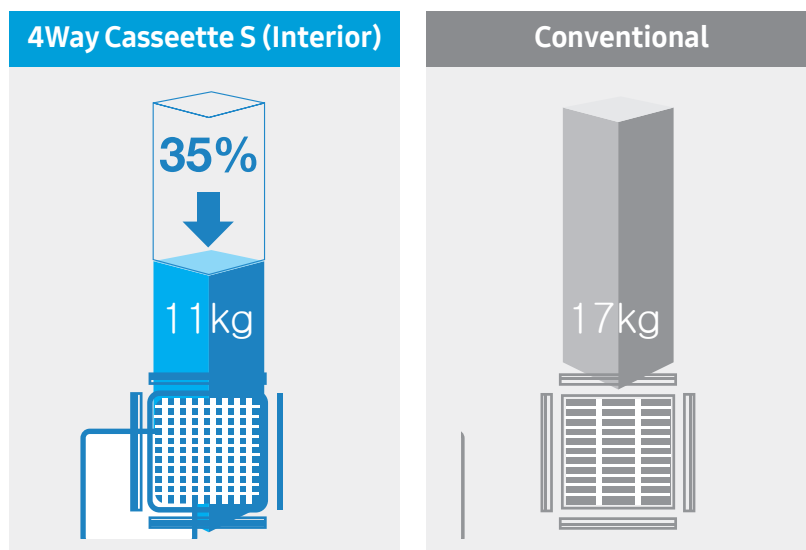

2-4-3 360 Cassette

■ **All round cooling and comfort**

The Samsung 360 Cassette air conditioner offers a brand new way of staying comfortably cool in every corner of the room. Its innovative circular design not only means it perfectly fits in everywhere, adding a sophisticated look to many different sites, but it also blows cool air in all directions, so that the whole room is the same temperature*. And its bladeless outlet ensures that cool air is gently dispersed, without creating a cold draft**, and doesn't block the air flow, even at low angles, so it expels 25% more air* and spreads it farther.

■ **EVENLY CIRCULATES & COOLS EVERY CORNER**

Unlike 4-way, cassette type air conditioners that create areas of uneven airflow where cool air can't reach*, a circular outlet blows cool air in all directions, so every corner of a room is the same temperature**.

* Samsung testing compared to a general 4 way cassette type air conditioner.

** Within an 9.3m radius the temperature difference is less than 0.6°C.

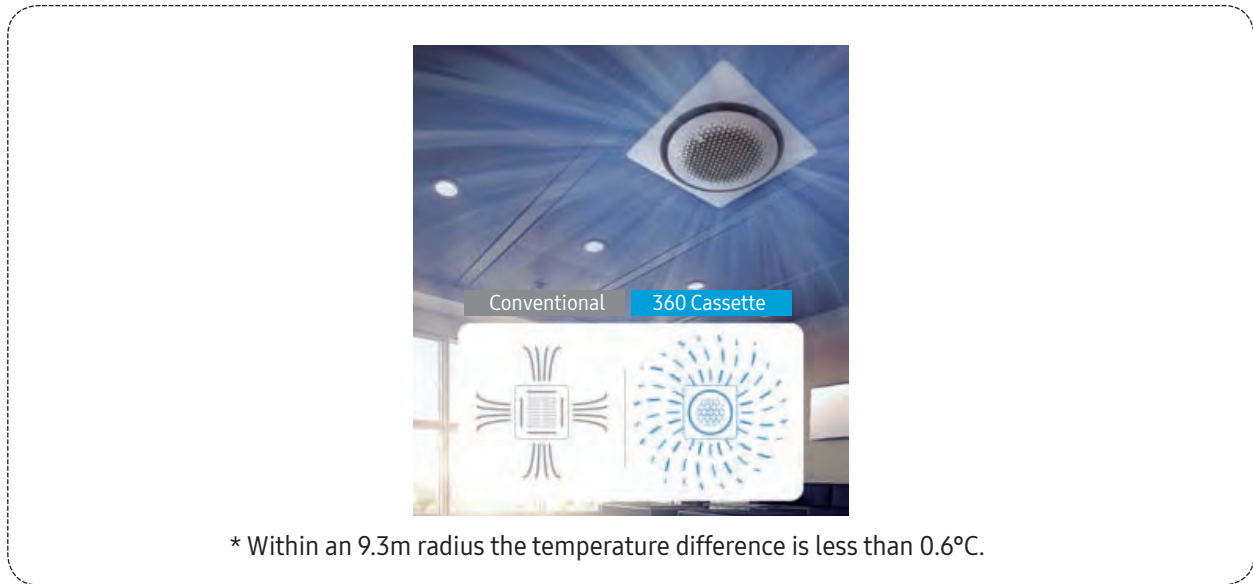

* Within an 9.3m radius the temperature difference is less than 0.6°C.

■ **Comfortably cool, not cold**

A bladeless design softly disperses cool air across the room, making you comfortably cool without feeling a cold draft**. With no blades to block the air flow, it also expels 25% more air* and spreads it farther.



* Within a 5m radius, no cold draft between 0~1.5m in height (with 14.0kw).

■ **Circular to perfectly fit in everywhere**

Its innovative circular design can match a multitude of interior designs, so it perfectly fits in everywhere. Its minimalist modern styling creates a sophisticated look and its circular shape stands out beautifully.



■ **Spreads more air in more ways**

An innovative Booster Fan enables cool air to be expelled at much lower angles. It creates a low pressure area around the outlet, so that cool air comes out parallel to the ceiling and disperses across a wider area.

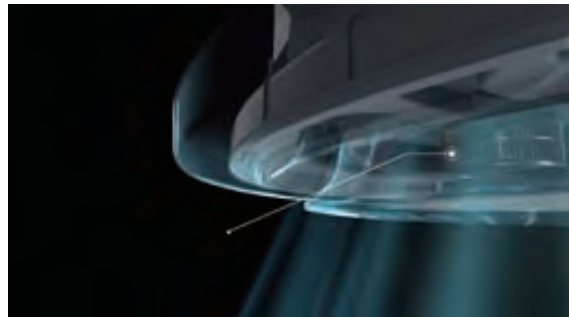

■ **All round simpler & intuitive control**

Intuitively control its performance and see where the air is going. The Wireless Remote Controller's* Jog shuttle and button offer a fun way to adjust the air flow and a Circular LED Display shows its direction.



2-4-4 Slim Duct - Ultra-light, adaptable design



- **Temper any environment with industry-best lightweight design and optimized airflow**
The new Samsung Slim Duct visually blends into the ceiling while providing powerful cool and warm airflow. It's also easy to install and maintain in any interior regardless of the surrounding environment with its compact size and weight—the lightest in the industry.
- **Flexible setup**
The air inlet can be set up either on the bottom or rear of the unit, giving users greater flexibility in installation.

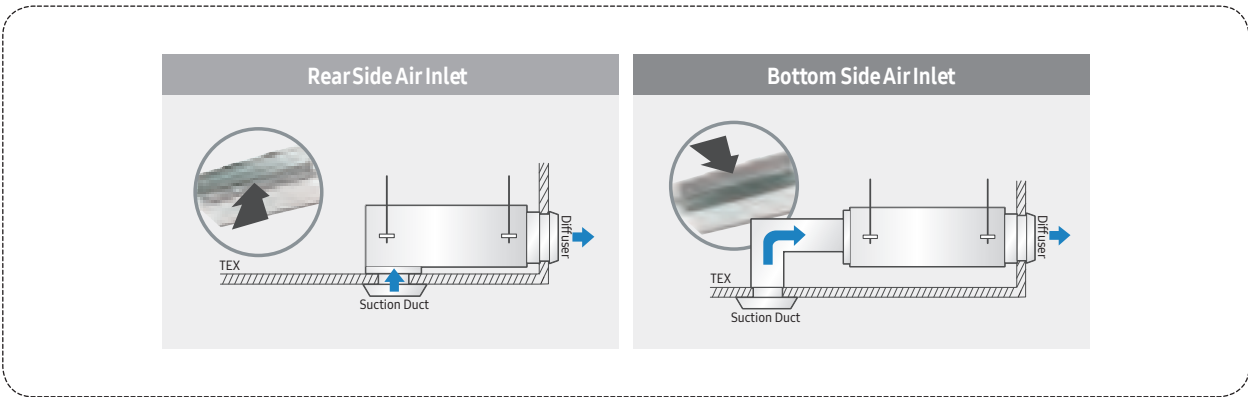

- **Simple drain pump installation**
The new drain pump in the Slim Duct unit can be installed from the side by simply removing the right side panel. Users no longer need to disassemble the top cover to install, check or repair the drain pump for maximum convenience.

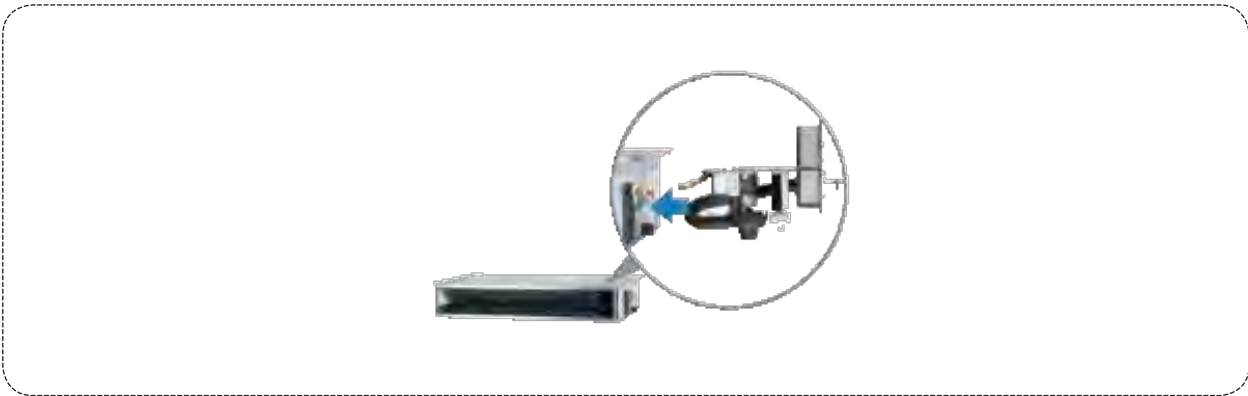

■ Various installation options

Slim Duct S adopts an ultra-compact, slim size with its thin width, which is 200 mm narrower than conventional products. This slender build enables flexible installation and maintenance in various environments..

■ World's lightest weight

The efficient Slim Duct S is the lightest duct air conditioning unit on the market. At a weight that's 15 percent lighter than conventional units, Slim Duct S offers the best in convenient installation and maintenance.

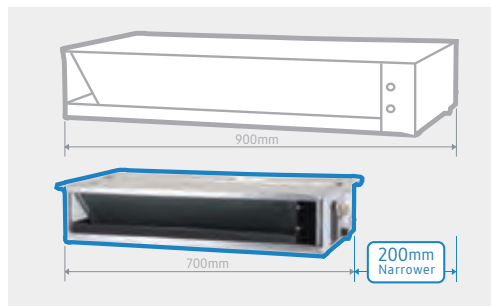
**■ Easy access, easy maintenance**

Slim Duct features a flexible design that enables users to easily access its parts to maintain the unit.



2-4-5 Duct S

■ Overview

Samsung Ducted Type air conditioning units are a smart solution for low-maintenance, consistent cooling and heating performance in any environment. Their compact, slim frame blends seamlessly into ceilings, enhancing the beauty of the interior space and affording users more flexible installation options. Offering a comprehensive lineup, Samsung Ducted Type air conditioning units offer just the right solution for every need—from the office or shop to the restaurant kitchen.

■ Experience performance and convenient comfort for any weather condition

Samsung Duct S delivers unparalleled cooling and heating and flexible management with customizable comfort settings in any climate—all year round. Plus, it boasts a slim, compact size and multiple access points for easy setup exactly where needed.



■ Smart pressure control

Samsung Ducted Type units feature a smart pressure control system. This system adjusts the fan speed based on the external static pressure (ESP), delivering consistent cooling and heating power, regardless of the surrounding environment.

■ Convenient installation

The optional lift-up drain pump lifts condensed water up to 750 mm, compared to a limit of 700 mm on conventional models, for flexible and convenient installation.

The Duct S indoor air conditioning unit delivers smooth, consistent operation and convenience with features such as:

- Efficient operation. Stage the desired atmosphere with energy-efficient performance and customized airflow.
- Smart management. Cool spaces efficiently and manage the air conditioning unit even while away, with features designed for efficiency and control.
- Easy, flexible setup. Install and maintain even multiple units with a compact and easily accessible design.

2-4-6 Ceiling Type - Slim yet functional design

■ Distribute refreshing airflow where needed with a compact, flexible design

Samsung's Ceiling Type indoor unit has 2-way installation options for the ceiling and floor, enabling more efficient use of available space. Users can enjoy crisp, powerful air throughout their entire space from the compact unit in the ceiling or floor.



■ Small package, big performance

The Samsung Ceiling Type air conditioner boasts a slim, compact design—half the size of conventional products—with cooling power comparable to larger units.

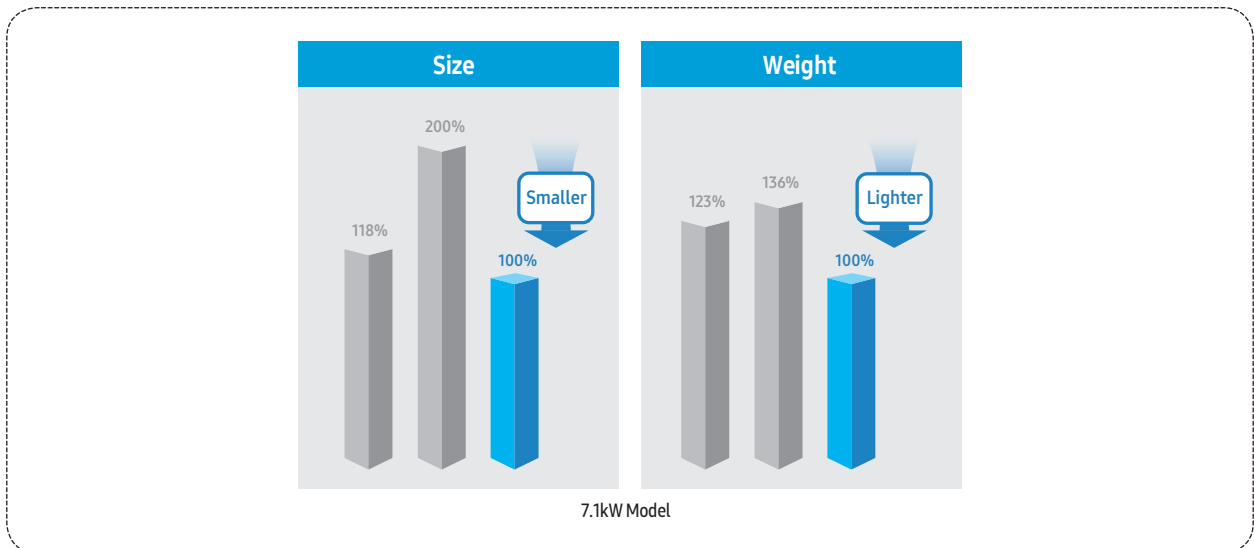

2-4-7 Wall Mount Type

■ Breathe easily with wall-mounted systems designed for all-day freshness

Samsung Wall Mount Type air conditioners have been designed from the ground up to be exceptionally efficient. With their stylish, innovative designs, these wall-mounted air conditioners optimize comfort with cool, clean, healthy freshness for everyday living.

■ Improved blade operation

Samsung's wide twin blade can open up to 90° for more effective cooling. The longer twin blade ensures that air reaches every corner of the room with greater control.

■ Superior dust filtration

A Full High Density (HD) filter creates cleaner air through enhanced filtration, reducing microscopic dust particles by up to 90 percent.

■ Cleaner, healthier air

Virus Doctor eliminates the harmful substances and viruses breeding in the atmosphere of living spaces, thus providing the highest level of indoor air quality. This smart solution creates a purified zone, eliminating the hazards of airborne allergens and controlling the active oxygen that contributes to disease, cancer and accelerated aging.

■ Good's sleep

Samsung's Wall Mount Type units feature Good's sleep mode for a comfortable bedroom climate perfectly tempered for a restful night. With automatic temperature and moisture adjustment, all three vital stages of sleep are protected from humidity and heat so users wake up fully rested and refreshed.

2-4-8 AR9000, 7000, 5000 Series - Triangular design, powerful cooling

■ Cool every corner of the room with a unique, efficiency-boosting design

Samsung AR9000, 7000, 5000 Series units are designed with efficiency in mind. Their uniquely triangular design improves performance to circulate cool, clean air throughout every inch of the room. In addition, their smart design includes easy-to-remove filters for easy management and healthier airflow.

■ Faster, farther cooling performance

The units' distinctive triangular design has a wider intake, so more air can be drawn in. The improved width and angle of the outlet, extra v-blades and bigger fan also ensure that air is cooled and expelled faster and farther. The result is refreshingly cool air that reaches every corner of the room—with no blind spots. Their Smart Inverter also provides significantly greater energy efficiency.





■ Easy-access maintenance





Unlike conventional filters that are often difficult to access, the Samsung wall-mounted unit filter is on the outside, at the top of the device. Easy access means users can take out the filter, clean it and put it back without having to open a cover or pull hard to get it out. And its antibacterial coating filters dust, dangerous airborne contaminants and allergens for healthier breathing.







2-5 Product Specifications

Model		Slim 1Way		
		IN	AC026RN1DKG/EU	AC035RN1DKG/EU
		OUT	AC026RXADKG/EU	AC035RXADKG/EU
Image	Indoor Unit			
	Outdoor unit			
	Remote controller			
Performance	cooling [W]		2.60	3.50
	heating [W]		3.30	4.00
Power Consumption	cooling [kW]		0.72	1.09
	heating [kW]		1.01	1.28
Voltage / Frequency [Ø, #, V, Hz]		1, 2, 220-240, 50		1, 2, 220-240, 50
Operating Current	cooling [A]		3.8	5.3
	heating [A]		5.0	6.2
Noise	indoor unit (C/H) [dBA]		40/42	42/44
	outdoor unit (C/H) [dBA]		51/51	53/53
Size	net dimension (W*D*H)	indoor unit [mm]	970 x 135 x 410	970 x 135 x 410
		outdoor unit [mm]	790 x 548 x 285	790 x 548 x 285
	shipping dimension (W*D*H)	indoor unit [mm]	1173 x 231 x 487	1173 x 231 x 487
		outdoor unit [mm]	913 x 622 x 371	913 x 622 x 371
Weight	net weight	indoor unit [mm]	9.2	9.2
		outdoor unit [mm]	32.5	32.5
	shipping weight	indoor unit [mm]	12.0	12.0
		outdoor unit [mm]	35.5	35.5
Harness Specification	indoor fan motor		DB31-00636G	DB31-00636G
	compressor		UB9AK5090FER	UB9AK5090FER
	outdoor fan motor		DB31-00642C	DB31-00642C
Designed Pressure	high pressure [Mpa]		4.1	4.1
	low pressure [Mpa]		1.4	1.4
Refrigerant/Factory charging [g]		R32		R32
		900		900
Additional refrigerant		0		0
Basic piping length [m]		5		5
Max.piping length [m]		20		20
max.level difference [m]		15		15
Option Code	Standard		01717C-1930F8-271A21-371120	01717C-19344D-272328-371120
	Installation 1		020000-100041- 200000-300000	020000-100051- 200000-300000
	Cycle		030000-100000-200000-300000	030000-100000-200000-300000
	Installation 2		050000-100000-200000-300000	050000-100000-200000-300000



Product Specifications (cont.)

Model		Mini 4 way				
		IN	AC026RNNDKG/EU	AC035RNNDKG/EU	AC052RNNDKG/EU	AC071RNNDKG/EU
		OUT	AC026RXADKG/EU	AC035RXADKG/EU	AC052RXADKG/EU	AC071RXADKG/EU
Image	Indoor Unit					
	Outdoor unit					
	Remote controller					
Performance	cooling [W]	2.60	3.50	5.00	6.80	
	heating [W]	3.40	4.00	5.50	7.50	
Power Consumption	cooling [kW]	0.67	1.03	1.53	2.75	
	heating [kW]	0.92	1.20	1.52	2.80	
Voltage / Frequency [Ø, #, V, Hz]		1, 2, 220-240, 50	1, 2, 220-240, 50	1, 2, 220-240, 50	1, 2, 220-240, 50	
Operating Current	cooling [A]	3.5	5.0	7.0	12.	
	heating [A]	4.6	5.7	7.0	12.	
Noise	indoor unit (C/H) [dBA]	38/39	41/42	43/44	46/46	
	outdoor unit (C/H) [dBA]	51/51	53/53	58/58	60/60	
Size	net dimension (W*D*H)	indoor unit [mm]	575 x 250 x 575	575 x 250 x 575	575 x 250 x 575	575 x 250 x 575
		outdoor unit [mm]	790 x 548 x 285	790 x 548 x 285	880 x 638 x 310	880 x 798 x 310
	shipping dimension (W*D*H)	indoor unit [mm]	623 x 298 x 653	623 x 298 x 653	623 x 298 x 653	623 x 298 x 653
		outdoor unit [mm]	913 x 622 x 371	913 x 622 x 371	1023 x 742 x 413	1023 x 896 x 413
Weight	net weight	indoor unit [mm]	11.5	11.5	12.0	12.0
		outdoor unit [mm]	32.5	32.5	43.0	51.0
	shipping weight	indoor unit [mm]	14.0	14.0	14.2	14.2
		outdoor unit [mm]	35.5	35.5	46.5	55.0
Harness Specification	indoor fan motor	DB31-00578C	DB31-00578C	DB31-00578C	DB31-00578C	
	compressor	UB9AK5090FER	UB9AK5090FER	UB9TK3150FE4	UB4TN8200FE4	
	outdoor fan motor	DB31-00642C	DB31-00642C	DB31-00658D	DB31-00579A	
Designed Pressure	high pressure [Mpa]	4.1	4.1	4.1	4.1	
	low pressure [Mpa]	1.4	1.4	1.4	1.4	
Refrigerant/Factory charging [g]		R32	R32	R32	R32	
		900	900	1200	1700	
Additional refrigerant		0	0	15g/m over 10m	25g/m over 15m	
Basic piping length [m]		5	5	5	5	
Max.piping length [m]		20	20	30	50	
max.level difference [m]		15	15	20	30	
Option Code	Standard	01517F-1910C8-271A22-370000	01517F-1930F9-272328-370000	01517F-19345D-27343C-370040	01517F-194581-274750-370040	
	Installation 1	020000-100001-200000-300000	020000-100001-200000-300000	020000-100001-200000-300000	020000-100031-200000-300000	
	Cycle	030000-100000-200000-300000	030000-100000-200000-300000	030000-100000-200000-300000	030000-100000-200000-300000	
	Installation 2	050000-100000-200000-300000	050000-100000-200000-300000	050000-100000-200000-300000	050000-100000-200000-300000	





Product Specifications (cont.)

Model		4Way CST		
		IN	AC052RN4DKG/EU	AC071RN4DKG/EU
		OUT	AC052RXADKG/EU	AC071RXADKG/EU
Image	Indoor Unit			
	Outdoor unit			
	Remote controller			
Performance	cooling [W]		5.00	7.10
	heating [W]		6.00	8.00
Power Consumption	cooling [kW]		1.43	2.38
	heating [kW]		1.49	2.45
Voltage / Frequency [Ø, #, V, Hz]			1, 2, 220-240, 50	1, 2, 220-240, 50
Operating Current	cooling [A]		6.5	10.3
	heating [A]		6.8	10.7
Noise	indoor unit (C/H) [dBA]		42/42	43/43
	outdoor unit (C/H) [dBA]		58/58	60/60
Size	net dimension (W*D*H)	indoor unit [mm]	840 x 204 x 840	840 x 204 x 840
		outdoor unit [mm]	880 x 638 x 310	880 x 798 x 310
	shipping dimension (W*D*H)	indoor unit [mm]	898 x 275 x 898	898 x 275 x 898
		outdoor unit [mm]	1023 x 742 x 413	1023 x 896 x 413
Weight	net weight	indoor unit [mm]	14.5	14.5
		outdoor unit [mm]	43.0	51.0
	shipping weight	indoor unit [mm]	18.0	18.5
		outdoor unit [mm]	46.5	55.0
Harness Specification	indoor fan motor		DB31-00578B	DB31-00578B
	compressor		UB9TK3150FE4	UB4TN8200FE4
	outdoor fan motor		DB31-00658D	DB31-00579A
Designed Pressure	high pressure [Mpa]		4.1	4.1
	low pressure [Mpa]		1.4	1.4
Refrigerant/Factory charging [g]			R32	R32
			1200	1700
Additional refrigerant			15g/m over 10m	25g/m over 15m
Basic piping length [m]			5	5
Max.piping length [m]			30	50
max.level difference [m]			20	30
Option Code	Standard	01417F-1940A8-27343C-370000	01417F-1940C8-274750-370000	
	Installation 1	020000-100001-200000-300000	020000-100001-200000-300000	
	Cycle	030000-100000-200000-300000	030000-100000-200000-300000	
	Installation 2	050000-100000-200000-300000	050000-100000-200000-300000	





Product Specifications (cont.)

Model		360 CST	
		IN	AC071RN4PKG/EU
		OUT	AC071RXADKG/EU
Image	Indoor Unit		
	Outdoor unit		
	Remote controller		
Performance	cooling [W]		7.10
	heating [W]		8.00
Power Consumption	cooling [kW]		2.73
	heating [kW]		2.48
Voltage / Frequency [Ø, #, V, Hz]			1, 2, 220-240, 50
Operating Current	cooling [A]		11.8
	heating [A]		10.7
Noise	indoor unit (C/H) [dBA]		43/43
	outdoor unit (C/H) [dBA]		60/60
Size	net dimension (W*D*H)	indoor unit [mm]	947 x 281 x 947
		outdoor unit [mm]	880 x 798 x 310
	shipping dimension (W*D*H)	indoor unit [mm]	990 x 330 x 990
		outdoor unit [mm]	1023 x 896 x 413
Weight	net weight	indoor unit [mm]	20.2
		outdoor unit [mm]	51.0
	shipping weight	indoor unit [mm]	24.5
		outdoor unit [mm]	55.0
Harness Specification	indoor fan motor		DB31-00578E
	compressor		UB4TN8200FE4
	outdoor fan motor		DB31-00579A
Designed Pressure	high pressure [Mpa]		4.1
	low pressure [Mpa]		1.4
Refrigerant/Factory charging [g]			R32
			1700
Additional refrigerant			25g/m over 15m
Basic piping length [m]			5
Max.piping length [m]			50
max.level difference [m]			30
Option Code	Standard		01017F-1940D8-274750-370000
	Installation 1		020000-100000-200000-300000
	Cycle		030000-100000-200000-300000
	Installation 2		050000-100000-200000-300000





Product Specifications (cont.)

Model		LSP Duct				
		IN	AC026RNLDKG/EU	AC035RNLDKG/EU	AC052RNLDKG/EU	AC071RNLDKG/EU
		OUT	AC026RXADKG/EU	AC035RXADKG/EU	AC052RXADKG/EU	AC071RXADKG/EU
Image	Indoor Unit					
	Outdoor unit					
	Remote controller					
Performance	cooling [W]	2.60	3.50	5.00	7.10	
	heating [W]	3.30	4.00	6.00	8.00	
Power Consumption	cooling [kW]	0.68	1.12	1.69	2.38	
	heating [kW]	0.87	1.21	1.74	2.38	
Voltage / Frequency [Ø, #, V, Hz]		1, 2, 220-240, 50	1, 2, 220-240, 50	1, 2, 220-240, 50	1, 2, 220-240, 50	
Operating Current	cooling [A]	3.6	5.4	7.7	10.5	
	heating [A]	4.5	5.8	7.8	10.4	
Noise	indoor unit (C/H) [dBA]	40/40	40/40	45/45	47/47	
	outdoor unit (C/H) [dBA]	51/51	53/53	58/58	60/60	
Size	net dimension (W*D*H)	indoor unit [mm]	700 x 199 x 600	700 x 199 x 600	1100 x 200 x 450	1100 x 200 x 450
		outdoor unit [mm]	790 x 548 x 285	790 x 548 x 285	880 x 638 x 310	880 x 798 x 310
	shipping dimension (W*D*H)	indoor unit [mm]	951 x 280 x 709	951 x 280 x 709	1319 x 270 x 529	1319 x 270 x 529
		outdoor unit [mm]	913 x 622 x 371	913 x 622 x 371	1023 x 742 x 413	1023 x 896 x 413
Weight	net weight	indoor unit [mm]	19.0	19.0	23.5	23.5
		outdoor unit [mm]	32.5	32.5	43.0	51.0
	shipping weight	indoor unit [mm]	23.0	23.0	27.0	27.0
		outdoor unit [mm]	35.5	35.5	46.5	55.0
Harness Specification	indoor fan motor		DB31-00653A	DB31-00653A	DB31-00638A	DB31-00638A
	compressor		UB9AK5090FER	UB9AK5090FER	UB9TK3150FE4	UB4TN8200FE4
	outdoor fan motor		DB31-00642C	DB31-00642C	DB31-00658D	DB31-00579A
Designed Pressure	high pressure [Mpa]		4.1	4.1	4.1	4.1
	low pressure [Mpa]		1.4	1.4	1.4	1.4
Refrigerant/Factory charging [g]		R32	R32	R32	R32	
		900	900	1200	1700	
Additional refrigerant		0	0	15g/m over 10m	25g/m over 15m	
Basic piping length [m]		5	5	5	5	
Max.piping length [m]		20	20	30	50	
max.level difference [m]		15	15	20	30	
Option Code	Standard	01C17C-1C1914-271A21-370000	01C17C-1C3936-272328-370000	01C17C-1C1924-27343C-370000	01C17C-1C59D0-274750-370005	
	Installation 1	020000-100000-200000-300000	020000-100000-200000-300000	020000-100000-200000-300000	020000-100000-200000-300000	
	Cycle	030000-100000-200000-300000	030000-100000-200000-300000	030000-100000-200000-300000	030000-100000-200000-300000	
	Installation 2	050000-100000-200000-300000	050000-100000-200000-300000	050000-100000-200000-300000	050000-100000-200000-300000	





Product Specifications (cont.)

Model		MSP Duct			
		IN	AC035RNMDKG/EU	AC052RNMDKG/EU	AC071RNMDKG/EU
		OUT	AC035RXADKG/EU	AC052RXADKG/EU	AC071RXADKG/EU
Image	Indoor Unit				
	Outdoor unit				
	Remote controller				
Performance	cooling [W]		3.50	5.00	6.80
	heating [W]		4.00	6.00	8.00
Power Consumption	cooling [kW]		1.02	1.60	2.32
	heating [kW]		1.15	1.64	2.50
Voltage / Frequency [Ø, #, V, Hz]			1, 2, 220-240, 50	1, 2, 220-240, 50	1, 2, 220-240, 50
Operating Current	cooling [A]		5.0	7.2	10.4
	heating [A]		5.4	7.4	10.8
Noise	indoor unit (C/H) [dBA]		40/40	45/45	47/47
	outdoor unit (C/H) [dBA]		53/53	58/58	60/60
Size	net dimension (W*D*H)	indoor unit [mm]	850 x 250 x 700	850 x 250 x 700	850 x 250 x 700
		outdoor unit [mm]	790 x 548 x 285	880 x 638 x 310	880 x 798 x 310
	shipping dimension (W*D*H)	indoor unit [mm]	1064 x 320 x 784	1064 x 320 x 784	1064 x 320 x 784
		outdoor unit [mm]	913 x 622 x 371	1023 x 742 x 413	1023 x 896 x 413
Weight	net weight	indoor unit [mm]	26.5	26.5	26.5
		outdoor unit [mm]	32.5	43.0	51.0
	shipping weight	indoor unit [mm]	30.5	30.5	30.5
		outdoor unit [mm]	35.5	46.5	55.0
Harness Specification	indoor fan motor		DB31-00639B	DB31-00639B	DB31-00639B
	compressor		UB9AK5090FER	UB9TK3150FE4	UB4TN8200FE4
	outdoor fan motor		DB31-00642C	DB31-00658D	DB31-00579A
Designed Pressure	high pressure [Mpa]		4.1	4.1	4.1
	low pressure [Mpa]		1.4	1.4	1.4
Refrigerant/Factory charging [g]			R32	R32	R32
			900	1200	1700
Additional refrigerant			0	15g/m over 10m	25g/m over 15m
Basic piping length [m]			5	5	5
Max.piping length [m]			20	30	50
max.level difference [m]			15	20	30
Option Code	Standard		01B17C-1C5080-272328-372008	01B17C-1C50F1-27343C-374000	01B17C-1C5436-274750-376000
	Installation 1		020000-100000-200000-300000	020000-100000-200000-300000	020000-100000-200000-300000
	Cycle		030000-100000-200000-300000	030000-100000-200000-300000	030000-100000-200000-300000
	Installation 2		050000-100000-200000-300000	050000-100000-200000-300000	050000-100000-200000-300000

Product Specifications (cont.)

Model		C-RAC				
		IN	AC026RNADKG/EU	AC035RNADKG/EU	AC052RNADKG/EU	AC071RNADKG/EU
		OUT	AC026RXADKG/EU	AC035RXADKG/EU	AC052RXADKG/EU	AC071RXADKG/EU
Image	Indoor Unit					
	Outdoor unit					
	Remote controller					
Performance	cooling [W]	2.60	3.50	5.00	7.10	
	heating [W]	3.30	4.00	6.00	8.00	
Power Consumption	cooling [kW]	0.74	1.10	2.20	2.35	
	heating [kW]	1.10	1.55	2.15	2.45	
Voltage / Frequency [Ø, #, V, Hz]		1, 2, 220-240, 50	1, 2, 220-240, 50	1, 2, 220-240, 50	1, 2, 220-240, 50	
Operating Current	cooling [A]	3.7	5.3	9.6	10.3	
	heating [A]	5.1	6.9	9.4	10.7	
Noise	indoor unit (C/H) [dBA]	43/43	43/43	48/48	51/51	
	outdoor unit (C/H) [dBA]	51/51	53/53	58/58	60/60	
Size	net dimension (W*D*H)	indoor unit [mm]	750 x 249 x 246	750 x 249 x 246	896 x 261 x 261	1065 x 294 x 301
		outdoor unit [mm]	790 x 548 x 285	790 x 548 x 285	880 x 638 x 310	880 x 798 x 310
	shipping dimension (W*D*H)	indoor unit [mm]	800 x 298 x 302	800 x 298 x 302	956 x 317 x 335	1123 x 354 x 384
		outdoor unit [mm]	913 x 622 x 371	913 x 622 x 371	1023 x 742 x 413	1023 x 896 x 413
Weight	net weight	indoor unit [mm]	7.6	7.6	10.8	14.4
		outdoor unit [mm]	32.5	32.5	43.0	51.0
	shipping weight	indoor unit [mm]	9	9	12.6	16.8
		outdoor unit [mm]	35.5	35.5	46.5	55.0
Harness Specification	indoor fan motor	DB31-00636A	DB31-00636A	DB31-00636A	DB31-00637A	
	compressor	UB9AK5090FER	UB9AK5090FER	UB9TK3150FE4	UB4TN8200FE4	
	outdoor fan motor	DB31-00642C	DB31-00642C	DB31-00658D	DB31-00579A	
Designed Pressure	high pressure [Mpa]	4.1	4.1	4.1	4.1	
	low pressure [Mpa]	1.4	1.4	1.4	1.4	
Refrigerant/Factory charging [g]		R32	R32	R32	R32	
		900	900	1200	1700	
Additional refrigerant		0	0	15g/m over 10m	25g/m over 15m	
Basic piping length [m]		5	5	5	5	
Max.piping length [m]		20	20	30	50	
max.level difference [m]		15	15	20	30	
Option Code	Standard	01017F-191448-271A21-371700	01017F-19548C-272328-371700	01017F-19548E-27343C-371700	01017F-19547F-274750-371700	
	Installation 1	020000-100000-200100-300000	020000-100000-200100-300000	020000-100000-200100-300000	020000-100000-200100-300000	
	Cycle	030000-100000-200000-300000	030000-100000-200000-300000	030000-100000-200000-300000	030000-100000-200000-300000	
	Installation 2	050000-100000-200000-300000	050000-100000-200000-300000	050000-100000-200000-300000	050000-100000-200000-300000	

Product Specifications (cont.)

Model		Ceiling		
		IN	AC052RNCDKG/EU	AC071RNCDKG/EU
		OUT	AC035RXADKG/EU	AC052RXADKG/EU
Image	Indoor Unit			
	Outdoor unit			
	Remote controller			
Performance	cooling [W]		5.00	7.10
	heating [W]		6.00	8.00
Power Consumption	cooling [kW]		1.58	2.87
	heating [kW]		1.92	3.05
Voltage / Frequency [Ø, #, V, Hz]			1, 2, 220-240, 50	1, 2, 220-240, 50
Operating Current	cooling [A]		7.2	12.4
	heating [A]		8.5	13.2
Noise	indoor unit (C/H) [dBA]		49/49	51/51
	outdoor unit (C/H) [dBA]		58/58	60/60
Size	net dimension (W*D*H)	indoor unit [mm]	1000 x 200 x 650	1000 x 200 x 650
		outdoor unit [mm]	880 x 638 x 310	880 x 798 x 310
	shipping dimension (W*D*H)	indoor unit [mm]	1074 x 294 x 726	1074 x 294 x 726
		outdoor unit [mm]	1023 x 742 x 413	1023 x 896 x 413
Weight	net weight	indoor unit [mm]	20	20
		outdoor unit [mm]	43.0	51.0
	shipping weight	indoor unit [mm]	25.0	25.0
		outdoor unit [mm]	46.5	55.0
Harness Specification	indoor fan motor		DB31-00646B	DB31-00646B
	compressor		UB9TK3150FE4	UB4TN8200FE4
	outdoor fan motor		DB31-00658D	DB31-00579A
Designed Pressure	high pressure [Mpa]		4.1	4.1
	low pressure [Mpa]		1.4	1.4
Refrigerant/Factory charging [g]			R32 1200	R32 1700
Additional refrigerant			15g/m over 10m	25g/m over 15m
Basic piping length [m]			5	5
Max.piping length [m]			30	50
max.level difference [m]			20	30
Option Code	Standard		01317F-1950F5-27343C-370000	01317F-195591-274750-370020
	Installation 1		020000-100000-200000-300000	020000-100000-200000-300000
	Cycle		030000-100000-200000-300000	030000-100000-200000-300000
	Installation 2		050000-100000-200000-300000	050000-100000-200000-300000

2-6 Specifications of optional items









2-6-1 Accessories

■ AC***RN4DKG

Item	Description	Code No.	Q'ty	Remark
	Ass'y drain hose	DB94-02719B	1	Indoor Unit
	Cable-tie	DB65-00191A	6	
	Seal-drain ass'y	DB62-05810A	1	
	Seal-drain ass'y	DB62-05810F	1	
	Seal-drain ass'y	DB62-05810G	1	
	CARD WARRANTY	DB68-02596B	1	
	User Manual	DB68-08166A	1	
	Installation Manual	DB68-08158A	1	
	BOLT-FLANGE	6011-003975	4	
	Installation Manual	DB68-07705A	1	
	CARD WARRANTY	DB68-02596B	1	

Accessories (cont.)

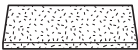
■ AC***RN1DKG

Item	Description	Code No.	Q'ty	Remark
	PAD INSTALL	DB69-01947A,B	1	Indoor Unit
	SEAL-DRAIN ASSY	DB62-05810A	1	
	HOSE DRAIN-JOINT	DB94-01258C	1	
	GROMMET-HANGER	DB63-00237A	8	
	MANUAL INSTALL	DB68-08158A	1	
	MANUAL USERS	DB68-08166A	1	
	INSULATION-BASE	DB72-00401C	2	
	CABLE TIE	DB65-10088C	3	
	CARD WARRANTY	DB68-02596B	1	





Accessories (cont.)

■ AC***RNNDKG

Item	Description	Code No.	Q'ty	Remark
	Ass'y drain hose	DB94-03287A	1	Essential Offer (Indoor Unit)
	Cable-tie	DB65-10088C	6	
	Seal-drain ass'y	DB62-11028A	1	
	Seal-drain ass'y	DB62-11028H	1	
	Seal-drain ass'y	DB62-11028J	1	
	USER MANUAL INSTALLATION MANUAL	DB68-08128A DB68-08129A	1	
	CARD WARRANTY	DB68-02596B	1	
	BOLT	6011-003975	4	Essential Offer (Panel)
	INSTALLATION MANUAL	DB68-03837A	1	

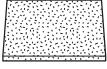
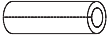
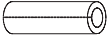
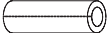





Accessories (cont.)

■ AC***RNLDKG
AC***RNMDKG

Item	Description	Code No.	Q'ty	Remark
	USER MANUAL INSTALLATION MANUAL	DB68-08130A DB68-08131A	1	Indoor Unit
	Insulation	DB62-04318S	1	
	Insu DRAIN HOSE	DB62-11028A	1	
	INSU HOSE D	DB62-11028E	1	
	INSU TUBE OUT	DB62-11028F	1	
	ASSY DRAIN HOSE JOINT	DB67-01191A	1	
	Ass'y Drain Hose Joint	DB90-06701A	1	
	GROMMET-HANGER	DB63-00237A	8	
	CARD WARRANTY	DB68-02596B	1	

Accessories (cont.)

■ AC***RNADKG

Item	Description	Code No.	Q'ty	Remark
	Remote Control	DB93-15882F	1	Essential Offer (Indoor Unit)
	Batteries for Remote Control	4301-000121	2	
	USER MANUAL INSTALLATION MANUAL	DB68-08134A DB68-08135A	1/1	
	Remote Control Holder	DB61-06087A	1	
	M4 x 16 Tapped Screws	6002-000234	2	
	Cap Screws	DB67-01404B	3	
	CARD WARRANTY	DB68-02596B	1	









Accessories (cont.)

■ AC***RNCDKG

Item	Description	Code No.	Q'ty	Remark
	USER MANUAL INSTALLATION MANUAL	DB68-08132A DB68-08133A	1	Indoor Unit
	PLATE WALL	DB61-01351A	2	
	Remote Control	DB93-15882F	1	
	Remote Control Holder	DB61-06087A	1	
	Batteries for Remote Control	4301-000121	2	
	M4 x 16 Tapped Screws	6002-000234	2	
	CARD WARRANTY	DB68-02596B	1	

Accessories (cont.)

■ AC***RN4PKG

Item	Description	Code No.	Q'ty	Remark
	ASSY DRAIN- HOSE	DB94-02719B	1	Standard / Indoor unit
	Cable tie	DB65-00191A	6	
	Seal-drain ass'y	DB62-05810A	1	
	Seal-drain ass'y	DB94-05810F	1	
	Seal-drain ass'y	DB94-05810G	1	
	Indoor unit installation manual	DB68-08157A	1	
	USER MANUAL	DB68-08165A	1	
	CARD WARRANTY	DB68-02596B	1	
	Bolt-flange	6009-001435	4	Standard / Panel
	INSTALL MANUAL	DB68-05903A	1	

3. Disassembly and Reassembly

■ Necessary Tools





Item	Remarks
+SCREW DRIVER	
Adjustable Wrench (8mm, 10mm, 13mm)	
M6, M8 Hex Wrench	

3-1 Indoor unit

■ AC026RN1DKG / AC035RN1DKG

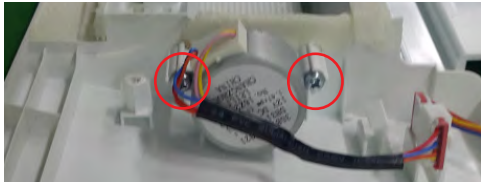

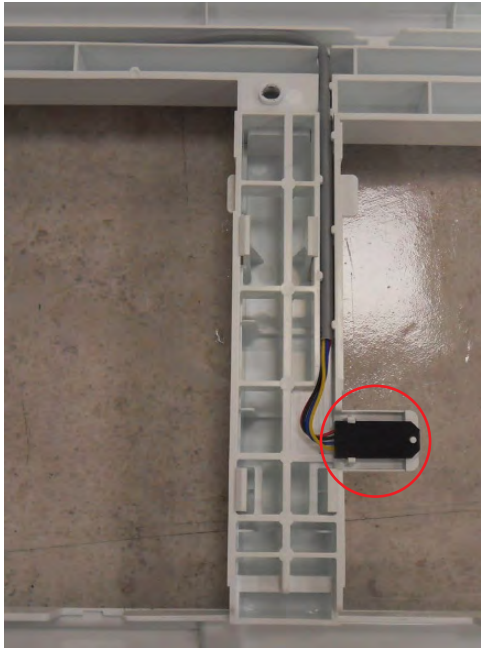
No	Parts	Procedure	Remark
1	PANEL And FILTER WIND FREE TYPE (PC1NWFMAN)	1) Open the GRILLE as shown in the figure. - 3point 2) Remove the FILTER from the PANEL. 3) Remove the 3 COVER SCREW as shown in the figure. 4) Remove the 6 screws fixed in PANEL and then remove the PANEL. (Use +Screw Driver) 5) Press the left and right PANEL HOOK and then separate the PANEL from the indoor unit.	

No	Parts	Procedure	Remark
1	PANEL And FILTER (Continues)	<p>6) Open the GRILLE and then separate the CLIP WIRE.</p> <p>7) Remove the screws fixed in COVER DISPLAY, COVER MOTOR RIGHT and then remove the COVER DISPLAY, COVER MOTOR RIGHT. (Use +Screw Driver)</p> <p>8) Disconnect the connector. (Remote control receiver PBA and Display PBA)</p>	   



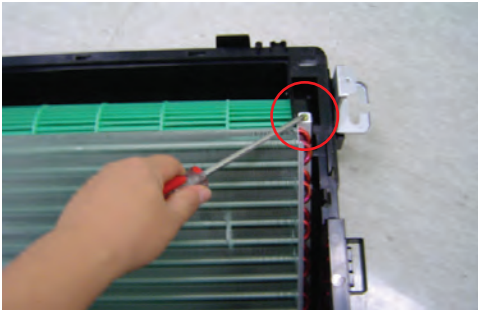
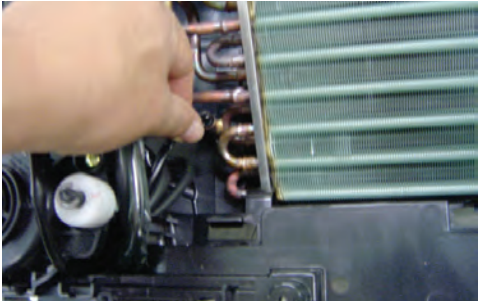
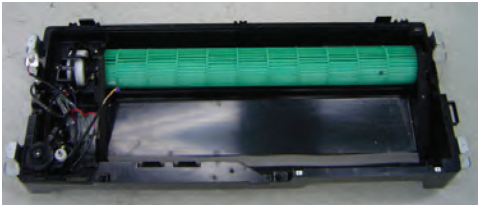
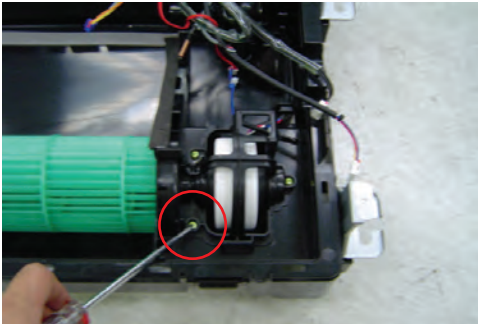
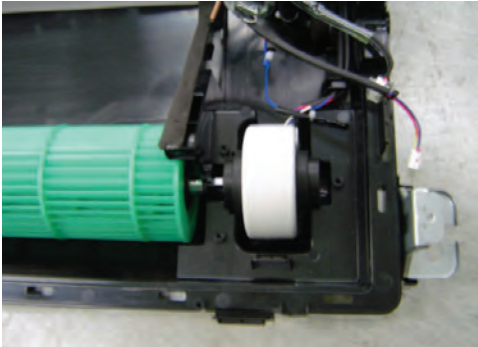

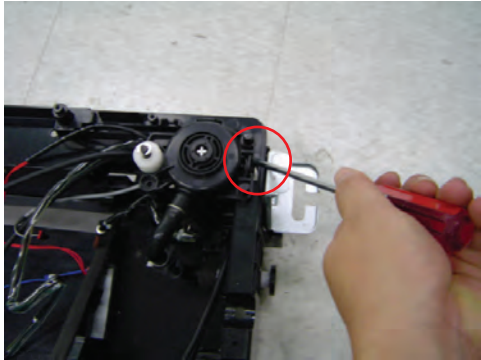
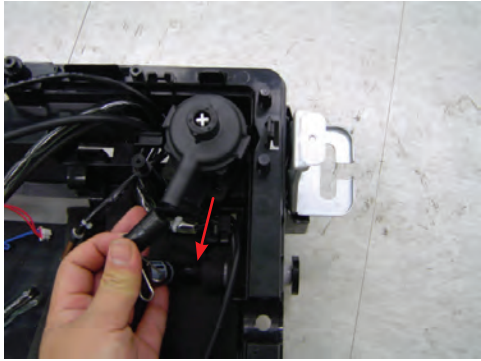
No	Parts	Procedure	Remark
1	PANEL And FILTER (Continues)	<p>9) Remove the 4 screws fixed in STEP MOTOR and then remove the MOTOR. (Use +Screw Driver)</p> <p>10) Remove the 4 HINGE and then separate the BLADE H.</p> <p>11) Separate the SENSOR HUMIDITY.</p> <p>12) Remove the 4 screws fixed in GUIDE AIR and then remove the GUIDE AIR. (Use +Screw Driver)</p> <p>13) Separate the PLATE.</p>	     

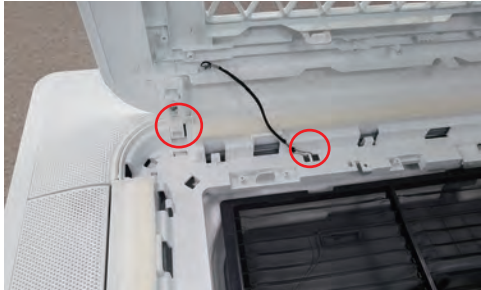

No	Parts	Procedure	Remark
		<p>2) Separate 8 connectors on the PCB of the Indoor Unit.</p> <p>3) Separate the Control In from the Indoor Unit.</p>	
2	Drain Sub	1) Push the hook on the Drain Sub to separate it.	

No	Parts	Procedure	Remark
3	Heat Exchanger	1) Undo fixing screw in the Heat Exchanger. (Use +Screw Driver) 2) Separate an Indoor Sensor from the Heat Exchanger. 3) Separate the Heat Exchanger from the Indoor Unit.	  
4	Cross Fan	1) Undo 3 fixing screws on the Cover Fan Motor. (Use +Screw Driver) 2) Separate the Cover Fan Motor from the Indoor Unit.	 

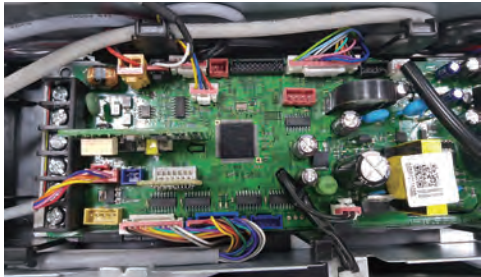

No	Parts	Procedure	Remark
4		3) Separate the Cross Fan from the Indoor Unit.	
5	Drain Pump	<p>1) Separate fixing screw in the Cover Drain Pump. (Use +Screw Driver)</p> <p>2) Separate the Drain Hose from the Drain Pump.</p> <p>3) Separate the Drain Pump from the Indoor Unit.</p>	  



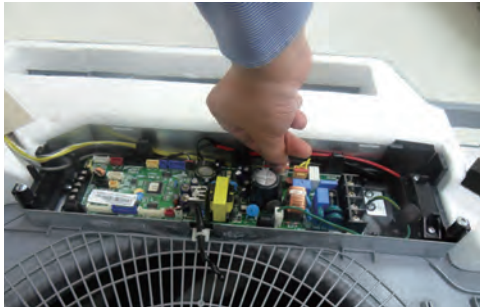
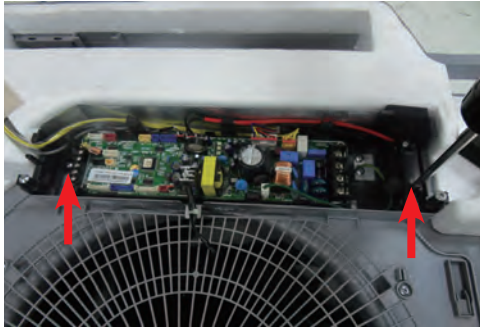
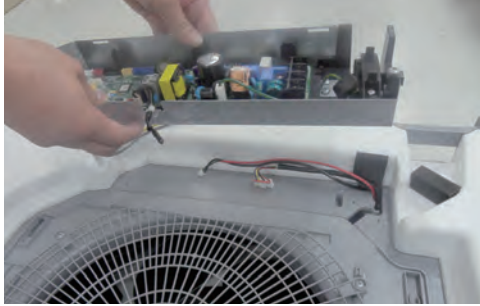

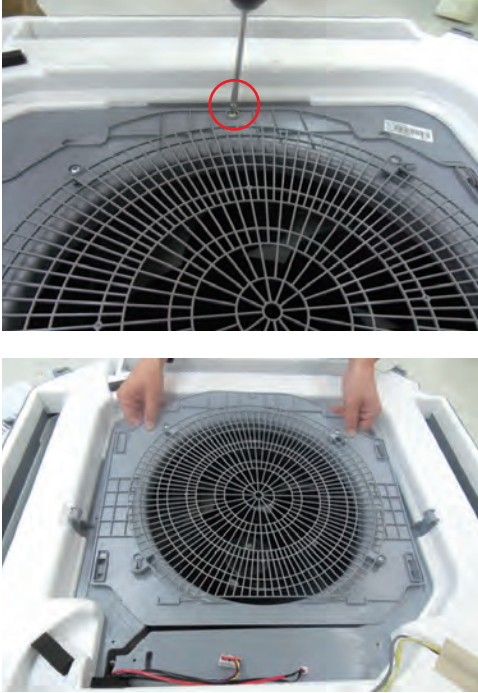
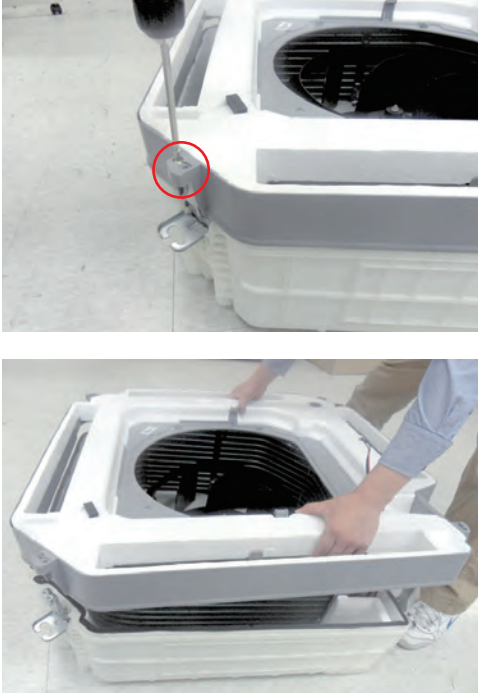
■ AC052RN4DKG / AC071RN4DKG

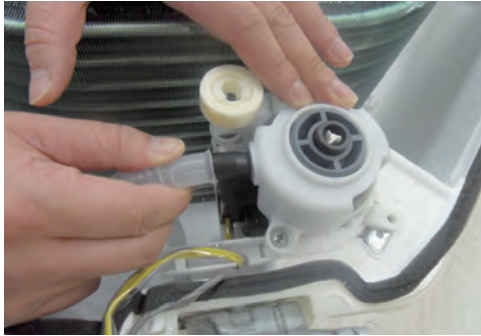
No	Parts	Procedure	Remark
1	Panel	<p>1) Pull two levers below Samsung logo to open the grille.</p> <p>2) Detach the safety clip and white link from the panel.</p> <p>3) Remove the 2 fixed screws to remove the Control-Box Cover. (Use +Screw Driver)</p> <p>4) Remove the 4 connector wires from the PBA. (Remocon-Receiver, Blade motor and Humidity sensor)</p> <p>5) Detach the 4 corners of the panel using both hands..</p>	    

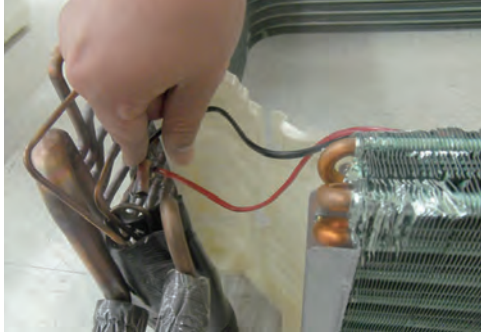
No	Parts	Procedure	Remark
1	Panel	6) Disassemble the bolts that are assembled with the indoor unit at the 4 panel corners.	
		7) Press the Steel Hangers at both sides of the panel inwards, and rotate them 90 degrees to remove it from the indoor unit's Hock. Remove the panel from the indoor unit.	
2	Control-Box	<p>1) Disconnect the Connector Wire that is connected to the indoor unit's PBA from the PBA.</p> <p>2) Unscrew the 2 fixed screws on both sides of the Control Box, and disassemble the Control Box from the indoor unit. (Use +Screw Driver)</p>	  

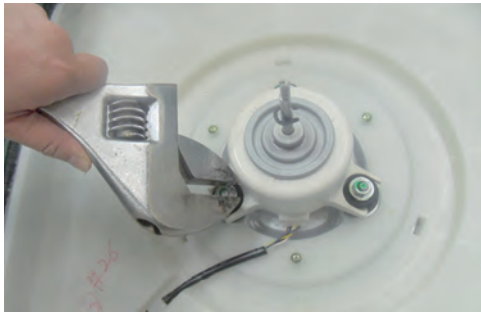
No	Parts	Procedure	Remark
3	Bell-Mouth	<p>1) Unscrew the screw fixed on the Bell-Mouth. (Use +Screw Driver)</p> <p>2) Push the Bell-Mouth in the direction opposite to where it's installed on the Control-Box to remove it.</p>	
4	Drain Pan	<p>1) Unscrew the screws on the 4 corners of the indoor unit. (Use +Screw Driver)</p> <p>2) Remove the Drain Pan from the indoor unit.</p>	





No	Parts	Procedure	Remark
5	Drain Pump & Hose	<p>1) Remove the 2 fixed screws and disconnect the white drainage hose from the Drain Pump. (Use +Screw Driver)</p> <p>2) Remove the 2 screws and take the Drain-Hose out from the indoor unit to disassemble the transparent Drain-Hose fixed on the side of the indoor unit. (Use +Screw Driver)</p>	  
6	Evap. Temperature Sensor	<p>1) Use your hand to remove the temperature sensor attached to the Evap Pipe along with the fixing clip.</p>	



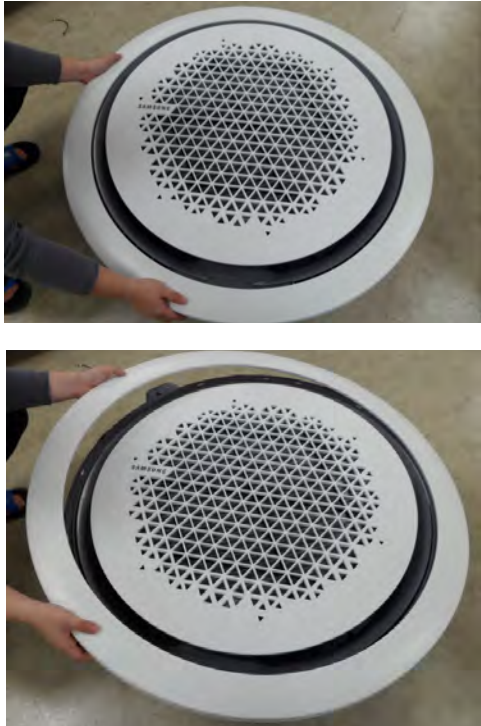

No	Parts	Procedure	Remark
7	Fan & Motor	<p>1) Turn the hexagonal nut attached to the top of the Fan counterclockwise to remove it. Take the Fan out of the Motor.</p> <p>2) Turn the three hexagonal nuts on the Motor counterclockwise to remove the nuts. Take the Motor Wires attached to these three locations out with your hands prior to removing the Motor.</p>	  
8	Evaporator	<p>1) Remove the screws of the 2 Steel Holder Evaps that are used to fix the Heat Exchanger, and then remove it. (Use +Screw Driver)</p> <p>2) Remove the 2 fixing screws of the Partition Evap at the Heat Exchanger's In/Out Pipe. (Use +Screw Driver)</p>	 

No	Parts	Procedure	Remark
		<p>3) Remove the screw of the Cover Pipe that is used to fix the In/Out Pipe. Remove the In/Out Pipe. (Use +Screw Driver)</p> <p>4) Remove the Heat Exchanger from the indoor unit's cabinet.</p>	  



■AC071RN4PKG

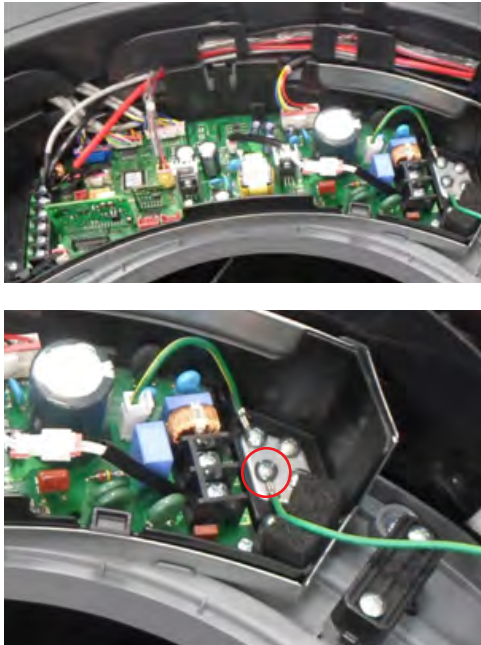
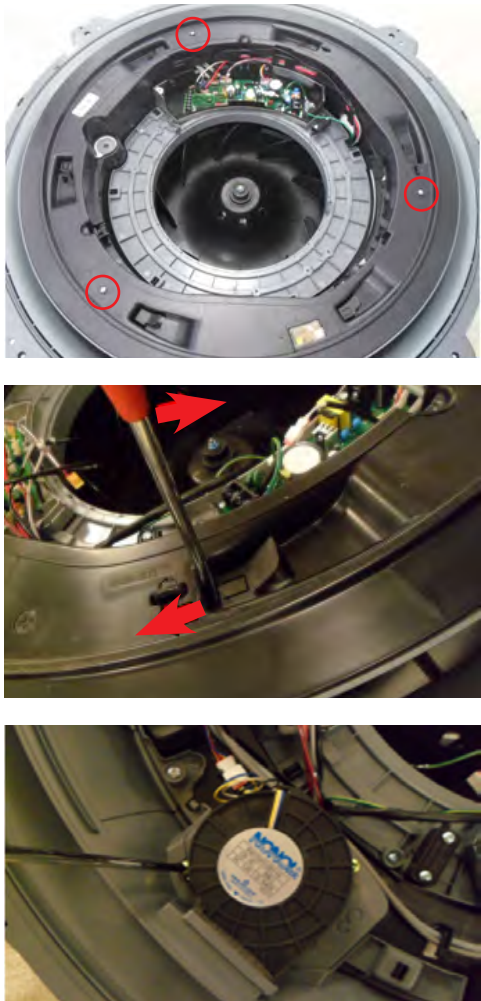

No.	Parts	Procedure	Remark
1	Panel	<p>► Ceiling type Panel</p> <p>1) Pull up the corner 4 places of Panel and separate it.</p> <p>2) Remove 4ea of screws from the corner of Panel. (Use +Screw Driver)</p> <p>3) Pull the hook of Panel and then separate the Panel from the Indoor Unit.</p>	
1	Panel	<p>► Open type Panel</p> <p>1) Rotate the outside Panel to counterclockwise direction and then separate it.</p>	

No.	Parts	Procedure	Remark
1	Panel	<p>2) Rotate the Grille to counterclockwise direction.</p> <p>3) Remove the safety clip of Grill inside and then separate the Panel from the Indoor Unit.</p> <p>4) Pull up the Filter from the Grill and separate it.</p>	  
2	Control Box	<p>1) Remove 2ea of screws which is fixed to the Indoor Unit upper part. (Use +Screw Driver)</p> <p>2) Rotate the Guard Fan to counterclockwise direction and separate it</p>	 

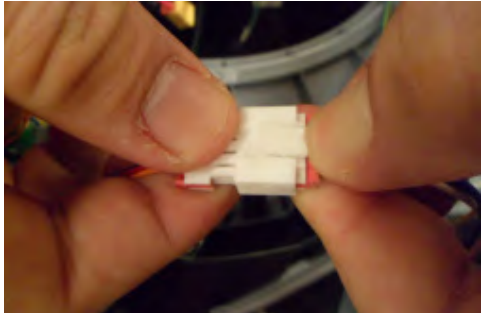
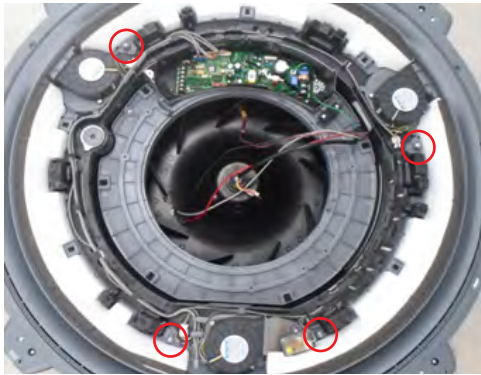

No.	Parts	Procedure	Remark
2	Control Box	<p>3) Remove a screw which is fixed to the Indoor Unit upper part. (Use +Screw Driver)</p> <p>4) Put finger in the "PULL" marked groove and then pull up the Cover</p> <p>5) Put finger in the "PULL" marked groove and then avoids the hook and it opens the Control Box Cover</p>	    

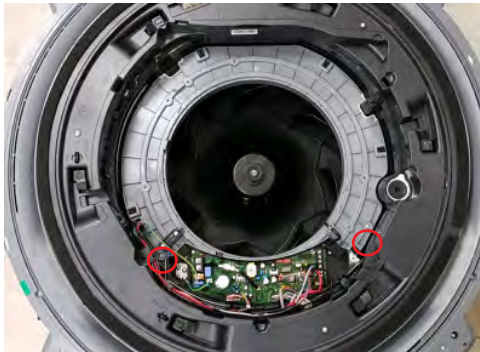

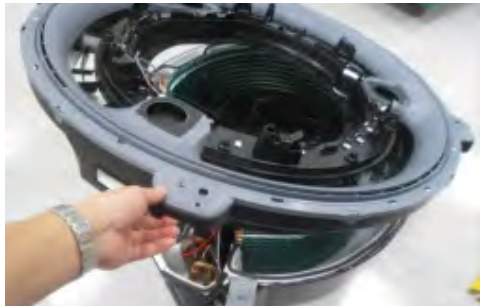

No.	Parts	Procedure	Remark
2	Control Box	6) Separate the connectors from the Control Box. 7) Remove the ground screw. (Use +Screw Driver)	
3	Top Cover & Drain Pan	1) Remove the 3ea of screws. (Use +Screw Driver) 2) Push the hook and separate the Cover. ⚠ Damage can occur to product in case of use a sharp tool. 3) Remove the screw which is fixed to Booster Fan. (Use +Screw Driver)	

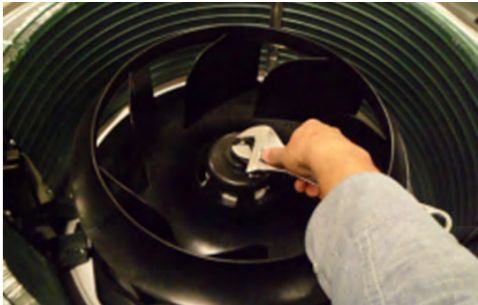
No.	Parts	Procedure	Remark
3	Top Cover & Drain Pan	<p>4) Pull the Booster Fan connector and separate the connector.</p> <p>5) Remove the 4ea of screws (Use +Screw Driver)</p> <p>6) Push the hook and separate the Cover.</p>	    

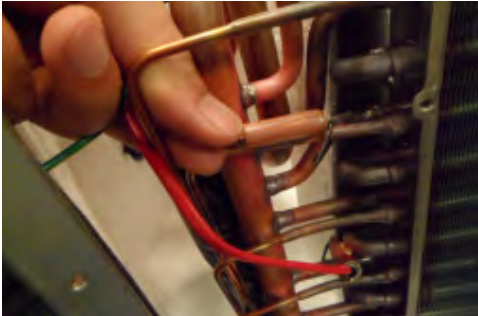

No.	Parts	Procedure	Remark
3	Top Cover & Drain Pan	<p>7) Remove the screw and separate the Display Cover. (Use +Screw Driver)</p> <p>8) Remove the 2ea of screws. (Use +Screw Driver)</p> <p>9) Push the hook and separate the Cover.</p> <p>10) Remove 8ea of screws. (Use +Screw Driver)</p> <p>11) Separate the Indoor Unit upper part from the Body.</p>	    

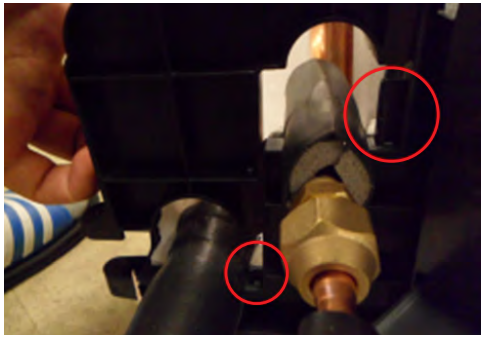
No.	Parts	Procedure	Remark
3	Top Cover & Drain Pan	<p>12) Remove the 3ea of screws. (Use +Screw Driver)</p> <p>13) Pull the hook that is on the side and separate the Cover.</p>	   
4	Drain Pump & Hose	1) Separate the Drain Hose from the Drain Pump.	

No.	Parts	Procedure	Remark
4	Drain Pump & Hose	2) Remove 2ea of screws and separate the Drain Hose that is on the side lower part of Indoor Unit. (Use +Screw Driver)	
5	Fan & Motor	1) Remove the hex nut which is fixed to top of Fan and separate the Fan from the Motor. (Use Monkey Spanner) 2) Remove the 3 hex nuts which is fixed to Motor and separate the Motor from the Indoor Unit. (Use Monkey Spanner)	 
6	Temperature Sensor	1) Remove 6ea of screws which are fixed to Evaporator and separate the Partition. 2) Separates the Temperature Sensor which is fixed to Evaporator Pipe with the fixing clip together by the hand.	 

No.	Parts	Procedure	Remark
7	Evaporator	<p>1) Remove 2ea of screws which are fixed to Indoor Unit and separate the Evaporator fixing bracket. (Use +Screw Driver)</p> <p>2) Remove a screw which is fixed to Indoor Unit and pull the hook and then separate the Drain Cover. (Use +Screw Driver)</p> <p>⚠ When assemble, be careful with the interference structure of piping projecting p</p> <p>3) Separate the Evaporator from the Indoor Unit.</p> <p>⚠ If you remove the Evaporator with bare hands, it may injure your hands, gloves must be worn.</p>	    



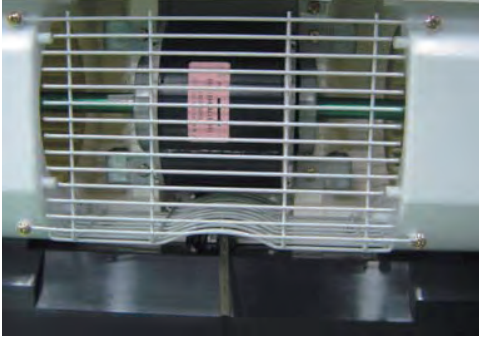

■ AC052RNCDKG / AC071RNCDKG

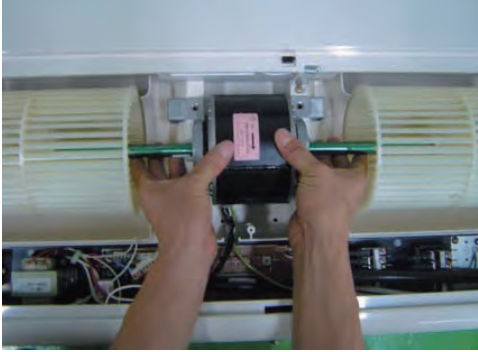

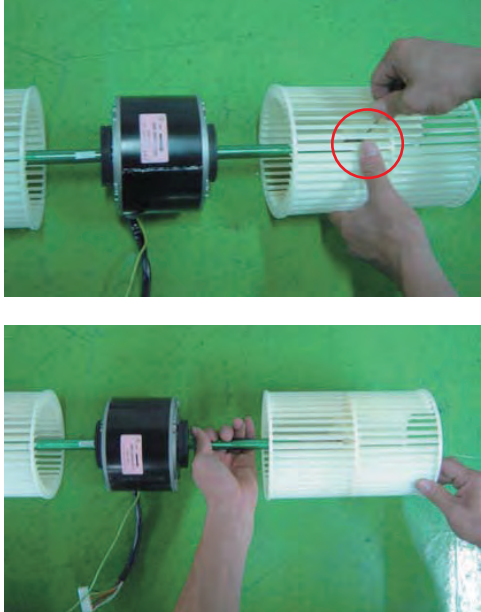
No	Parts	Procedure	Remark
1	PANEL And FILTER WIND FREE TYPE (PC1NWFMAN)	<p>1) Open the Grille by pressing 3 position. (center and both side)</p> <p>2) Detach the Air Inlet Grille.</p> <p>3) Open the Cover of component Electrical Box removing 3 screws. (center and both side)</p>	   



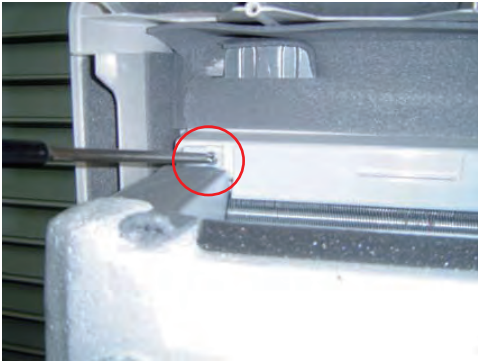

No.	Parts	Procedure	Remark
			
2	Fan & Motor	<p>1) Detach the screw and untie earth wire of Motor.</p> <p>2) Disconnect of housing of Motor Wire.</p> <p>3) Disconnect the Capacity Wire.</p>	

No.	Parts	Procedure	Remark
		<p>4) Loosen the Guard Safety by removing 6 screws.</p>	
		<p>5) Detach the Upper Case of Fan. (2EA)</p>	
		<p>6) Loosen the 4 screws what is fix the Motor.</p>	
		<p>7) Detach the Fan and Motor assembly.</p>	



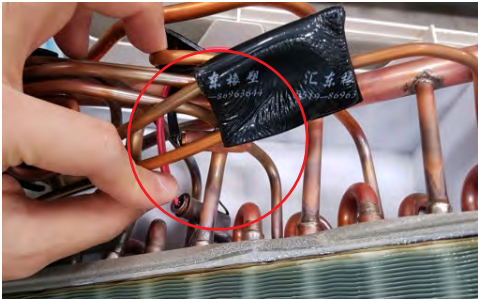

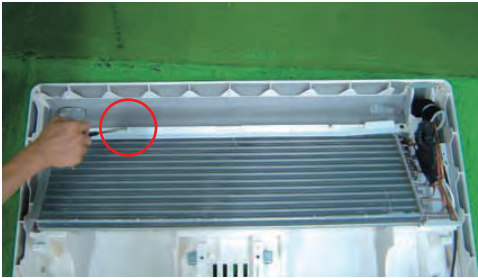
No.	Parts	Procedure	Remark
		<p>8) Loosen the set fixing bolts. (with a M3 wrench)</p> <p>9) Detach the Fan.</p>	
3	Drain Pan	<p>1) Disconnect the Display PCB Wire as shown in picture. (White housing)</p> <p>2) Disconnect the Step Motor Wire as shown in picture. (blue housing)</p> <p>3) Dosassemble the Hanger Bracket by removing the 1 screw.</p>	











No.	Parts	Procedure	Remark
		<p>4) Loosen the 3 screws of Front Side.</p> <p>5) Disassemble the assembly Front Cover Part.</p> <p>6) Disconnect the Step Motor Wire as shown in picture.</p> <p>7) Detach Wire Clamp fixed in Base Part.</p> <p>8) Detach the Front Cover assembly completely.</p>	    

No.	Parts	Procedure	Remark
		<p>9) Loosen the screw what is fix with Base Part and Drain Pan. (Upper Sied:2EA)</p> <p>10) Loosen the screw what is fix with Base Part and Drain Pan. (Lower Side:2EA)</p> <p>11) Detach the Drain Pan completely.</p>	  

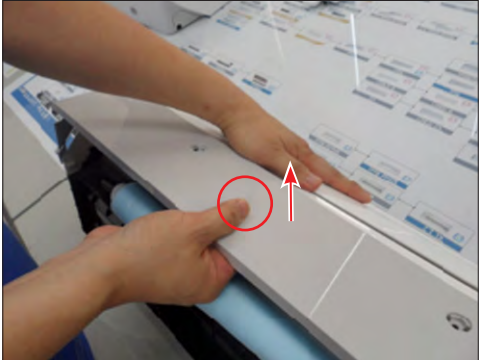

No.	Parts	Procedure	Remark
4	Evaporator	<p>1) Disconnect the Thermistor Wire as shown in picture. (white housing)</p> <p>2) Loosen the 2 screws shown in picture.</p> <p>3) Loosen the 2 screw shown in picture and and remove Plastic Part. (white)</p> <p>4) Loosen the 2 screw shown in picture and remove Steel Bracket.</p> <p>5) Disassemble the 4 screws Steel Plate in rear side of the unit.</p>	    

■ AC026RNADKG / AC035RNADKG / AC052RNADKG / AC071RNADKG

No	Parts	Procedure	Remark
1	Panel-Front	<p>1) Stop the driving of air conditioner and shut off main power supply.</p> <p>2) Detach FILTER PRE from the PANEL FRONT.</p> <p>3) Cover Panel is assembled on bottom of indoor unit as shown in the figure. Remove the Cap Screw as shown on the right side and then remove the screw and separate the Cover Panel.</p>	   

No	Parts	Procedure	Remark						
		<p>4) Cover Panel is fixed to body by Hook in center area and side area.</p> <p>5) Separate the hook after pushing both end of Cover Panel as shown in the figure. (Watch out for the damage of the hook)</p> <p>6) Raise front part upward obliquely as shown in the figure and then remove the hooks.</p>	 <table border="1" data-bbox="930 622 1410 779"> <thead> <tr> <th colspan="2">HOOK</th> </tr> </thead> <tbody> <tr> <td>026/035</td> <td></td> </tr> <tr> <td>052/071</td> <td></td> </tr> </tbody> </table>   	HOOK		026/035		052/071	
HOOK									
026/035									
052/071									

No	Parts	Procedure	Remark
		<p>⚠ Assembly of Cover Panel after service end.</p> <ul style="list-style-type: none"> - Reassembly is in the reverse order of the removal. - Piping and drain hose must be careful not to damage and Progress must be done with both hands. 	 <p>Hook (Side)</p> <p>Hook (Center)</p> <p>Screw</p> <p>Cap Screw</p>

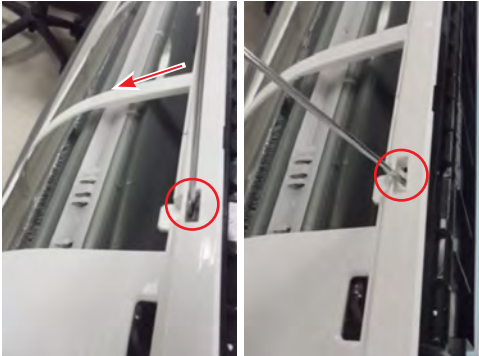

No	Parts	Procedure	Remark
		<p>7) To detach the PANEL-FRONT from the main frame, unfasten 2 screws at the bottom. (use + Screw Driver)</p> <p>8) To detach the COVER-PANEL from the main frame, loosen 4 HOOK Structures. When separate the hook : Use the (-) screw Driver. (-)Screw Driver Insert the hook and then pull the hook as shown on the right side. (Watch out for the damage of the hook)</p>	   

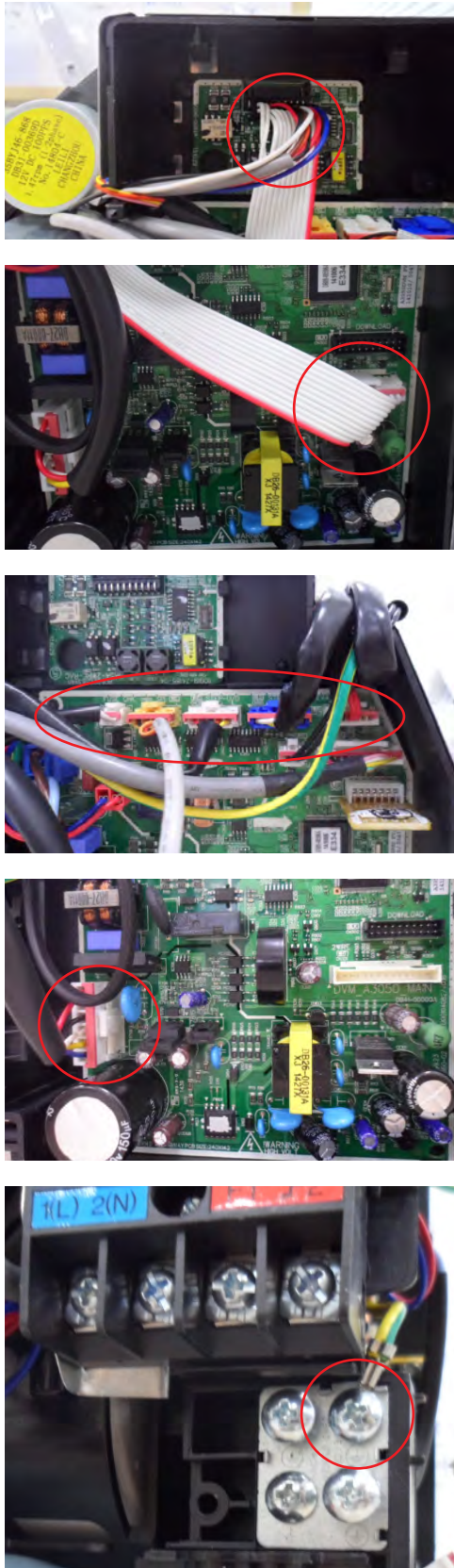
No	Parts	Procedure	Remark
		<p>9) Remove the Panel Frame from the Main Frame as shown on the right side.</p>	 <p>The Remark column contains three sequential photographs illustrating the disassembly process. The first photo shows a person's hands pulling the white panel frame away from the main unit, with a red curved arrow indicating the direction of movement. The second photo shows the removed white panel frame lying on a green surface. The third photo shows the main frame of the unit, which is a long, rectangular metal housing with internal components visible.</p>

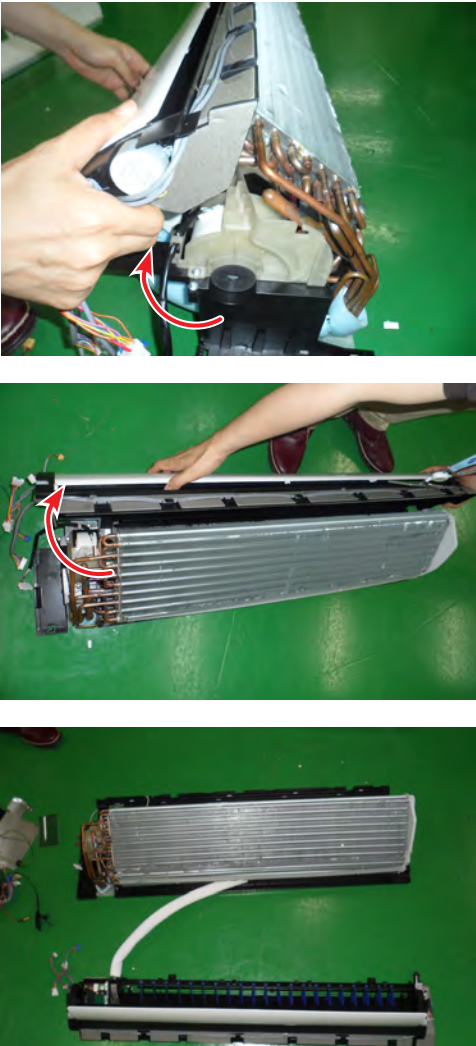
No	Parts	Procedure	Remark
2	Control In	<p>1) Disconnect Sub PBA Wire.</p> <p>⚠ When you separate the connector, pull pressing the locking button.</p> <p>2) Disconnect Stepping Motor, EEV, Display, Sensor, SPI, Fuse Wire.</p> <p>⚠ When you separate the connector, pull pressing the locking button.</p> <p>3) Disconnect Motor, Terminal Wire.</p> <p>⚠ When you separate the connector, pull pressing the locking button.</p> <p>4) Loosen Earth Wire.</p>	

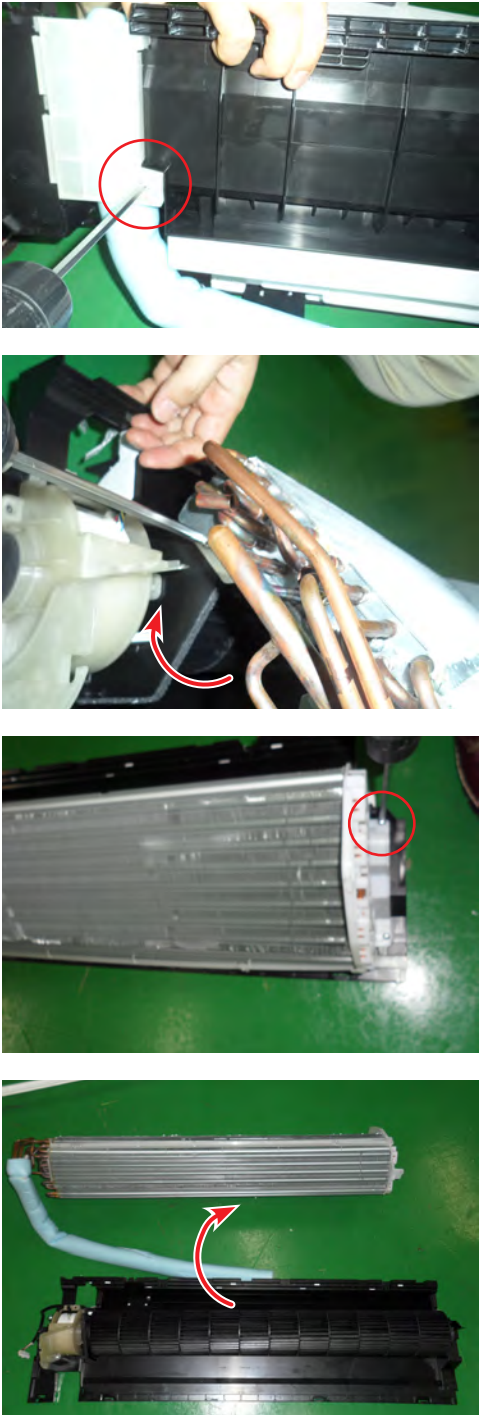
No	Parts	Procedure	Remark
3	Tray Drain	1) To detach TRAY-DRAIN from the main frame, pull the bottom of the TRAY-DRAIN towards you.	

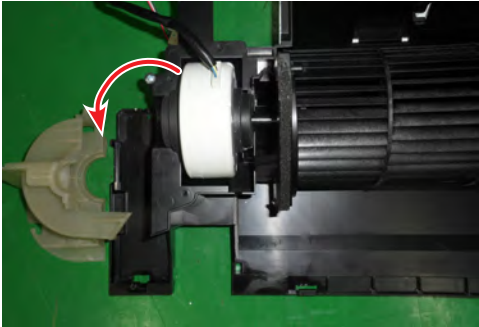
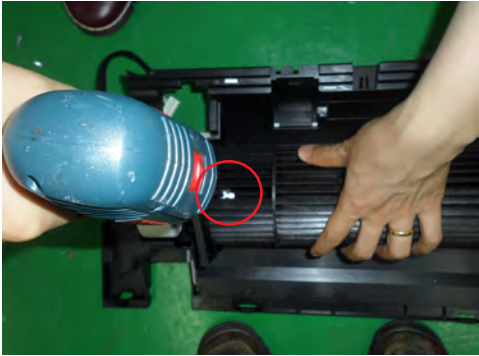

No	Parts	Procedure	Remark
4	Evaporator	<p>1) Detach the HOLDER PIPE.</p> <p>2) Unfasten the screw at the left side. (use + Screw Driver)</p> <p>3) Unfasten the screw at the right side. (use + Screw Driver)</p> <p>4) To detach Evaporator from the main frame, pull the bottom of the Evaporator towards you.</p>	

No	Parts	Procedure	Remark
5	Fan motor & Cross fan	<p>1) Unfasten the screw. (use + Screw Driver)</p> <p>2) Detach the FAN Motor case.</p> <p>3) Unfasten the screw a little. (use + Screw Driver)</p> <p>4) Pull the CROSS-FAN to the left side.</p>	   

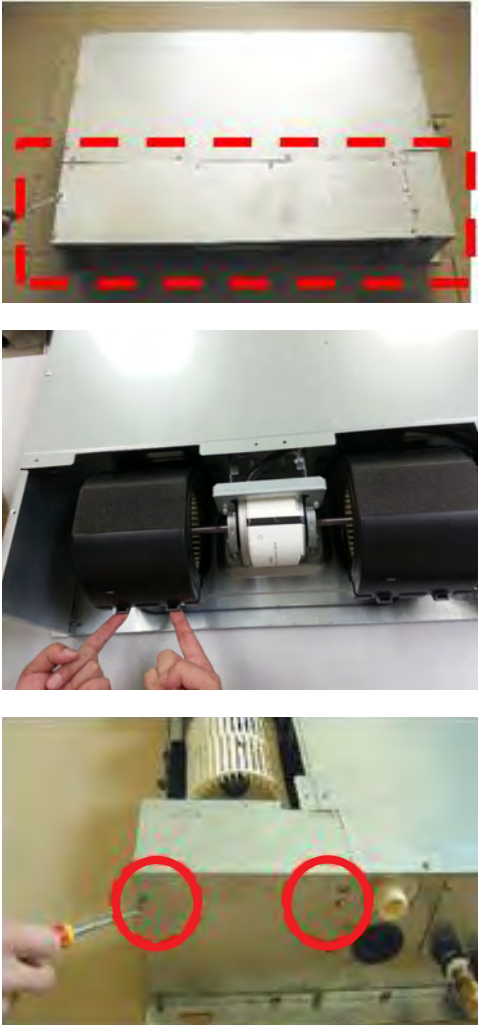
■ AC026RNLDKG / AC035RNLDKG

No	Parts	Procedure	Remark
1	Motor & Blower	<p>1) Disassemble the Cabinet Top Motor. - Unscrew 8 screws</p> <p>2) Disassemble the Cover Blower Upper with pushing its hook.</p> <p>3) Disassemble the Cover Control. - Unscrew 2 screws</p>	

No	Parts	Procedure	Remark
		<p>4) Disassemble Motor Wires connected to the inside of PCB and connected to the Capacitor.</p> <p>5) Disassemble the Motor wire with pushing the clip.</p> <p>6) Disassemble the band Motor for fixing the Motor. - Unscrew 2 screws</p> <p>7) After disassembling the Motor and Blower for the set, disassemble the Blower by use of 3mm wrench.</p>	   

No	Parts	Procedure	Remark
2	Drain Pan	<p>1) Disassemble the Cabinet Top Evap. - Unscrew 11 screws</p> <p>2) Disassemble the Bracket Outlet Sub that fixes the Drain Pan equipped on the front of the set. - Unscrew 6 screws</p> <p>3) Disassemble the Drain Cushion from the set.</p>	  

No	Parts	Procedure	Remark
3	Evaporator	<p>► The Evaporator should be disassembled after disassembling the Cover Control (1-3) and the Drain Pan (2-1), (2-2), (2-3).</p> <p>1) Disassemble the Cover Pipe that fixes the high/low pressure Pipe. - Unscrew 2 screws</p> <p>2) Disassemble the refrigerant temperature sensor, Inlet air temperature sensor, and EEV wire that connected to the inside of PCB.</p> <p>3) Disassemble the Support Evap. LF that fixes the Evaporator. - Unscrew 2 screws</p> <p>4) Disassemble the Support Evap RH. - Unscrew 2 screws</p>	

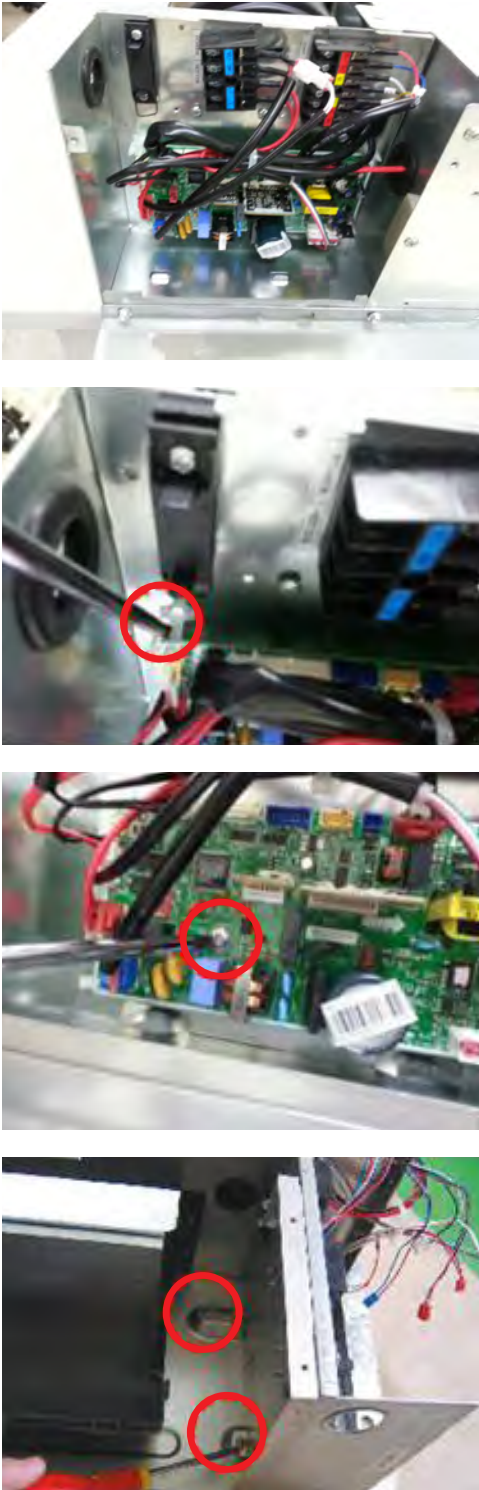

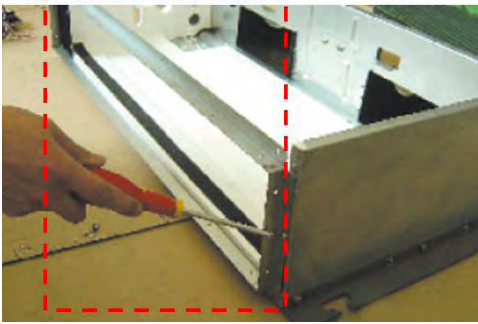
No	Parts	Procedure	Remark
4	Control In	<p>► The Control In should be disassembled after disassembling the Cover Control 1-3).</p> <p>1) Disassemble all Control Wires connected to the inside of PCB.</p> <p>2) In case of disassembling the PCB separately, disassemble the PCB from the case with pushing the hook after unscrewing the screw. - Unscrew 1 screw</p> <p>3) In case of disassembling the Case Control, disassemble the Case Control from the set after unscrewing the screw connected to the direction of Blower. - Disassemble if after disassembling the Cabinet Top Motor 1-1.</p>	

No	Parts	Procedure	Remark
5	Bracket Outlet	1) Disassemble the Bracket Outlet assembled on the Cabinet. - Unscrew 10 screws	

■ AC052RNLDKG / AC071RNLDKG

No	Parts	Procedure	Remark
1	Motor & Blower	<p>1) Disassemble the Cabinet Bottom Fan. - Unscrew 10 screws</p> <p>2) Disassemble the Case Filter Pre.</p> <p>3) Disassemble frame-up. - Unscrew 2 screws</p> <p>4) Disassemble the case blower. - Unscrew 3 screws</p> <p>5) Disassemble cover control. - Unscrew 2 screws</p>	    

No	Parts	Procedure	Remark
		<p>5) Cut the cable-tie.</p> <p>6) Disconnect the wire between assy control out and motor.</p> <p>7) Disassemble the 2 Holder Motor. - Unscrew 2 screws</p> <p>8) After disassembling the Motor and Blower for the set, disassemble the Blower by use of 3mm wrench.</p> <p>9) Disassemble the both of Case Blower Out. - Unscrew 6 screws</p>	    

No	Parts	Procedure	Remark
2	Drain Pan	1) Disassemble the Cabinet Bottom Evap. - Unscrew 7 screws 2) Pull the Drain Pan Out.	
3	EVAP	1) Disassemble the Cover Pipe. - Unscrew 2 screws 2) 1) Disassemble the Support Evap and hold evap. - Unscrew 3 screws 3) Disconnect the wire between assy control out and Evap.	

No	Parts	Procedure	Remark
		4) Then pull the Evap out.	
4	Cushion	<p>1) Pull out the seal Cushion front.</p> <p>2) Disassemble the Seal Cushion Right. - Unscrew 1 screws.</p> <p>3) Disassemble the Assy Cushion LF. - Unscrew 1 screws.</p>	  

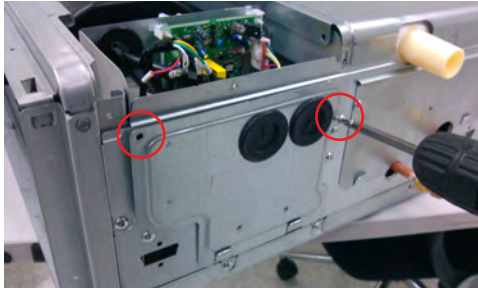
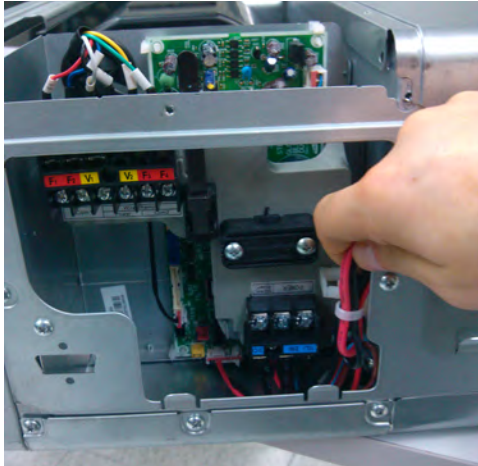
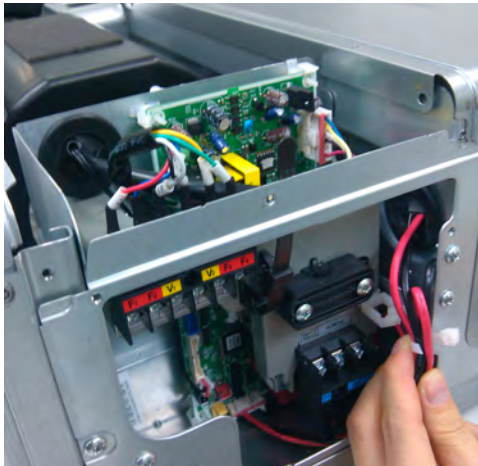



No	Parts	Procedure	Remark
5	Bracket Motor	1) Disassemble the Bracket Motor. - Unscrew 6 screws	
6	Control	1) Loosen 2 screws of Assy control in and Remove the assy control in. 2) Remove wires from wire saddle. 3) clip cable tie. (It is necessary to re-tie "cable tie" on re-assembly, then place in wire saddle .)	  



No	Parts	Procedure	Remark
7	Frame	1) Disassemble the Frame. - Unscrew 4 screws	

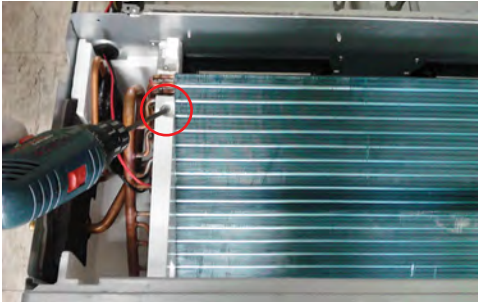

■ AC035RNMDKG / AC052RNMDKG / AC071RNMDKG

No	Parts	Procedure	Remark
1	Motor & Blower	<p>1) Disassemble the Cabinet Bottom Fan. - Unscrew 10 screws</p> <p>2) Disassemble the Case Filter Pre.</p> <p>3) Disassemble the 2 Case Blower Bottom. - Unscrew 4 screws</p> <p>4) Disassemble the Cover Control. - Unscrew 2 screws</p> <p>5) Cut the cable-tie</p>	    



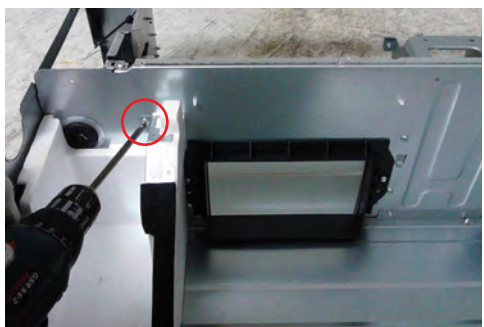

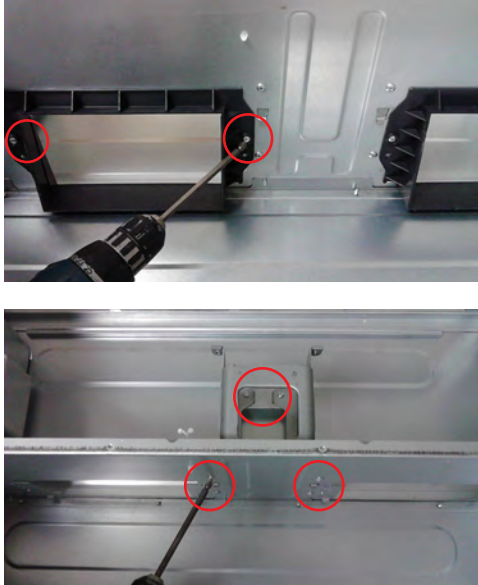
No	Parts	Procedure	Remark
		<p>6) Disconnect the wire between assy control out and motor.</p> <p>7) Disassemble the 2 Holder Motor. - Unscrew 2 screws.</p> <p>8) After disassembling the Motor and Blower for the set, disassemble the Blower by use of 3mm wrench.</p> <p>9) Disassemble the both of Case Blower Out - Unscrew 4 screws</p>	   

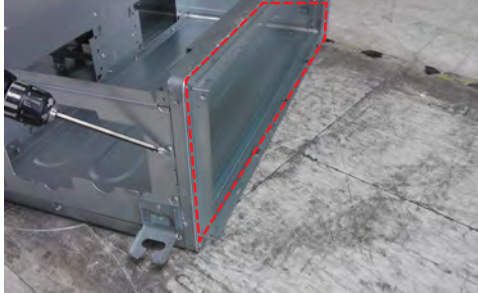

No	Parts	Procedure	Remark
2	Drain Pan	1) Disassemble the Cabinet Bottom Evap. - Unscrew 7 screws 2) Pull the Drain Pan Out.	 
3	EVAP	1) Disassemble the Support Evap. - Unscrew 1 screws 2) Disassemble the Cover Pipe. - Unscrew 2 screws 3) Disconnect the wire between assy control out and Evap.	  

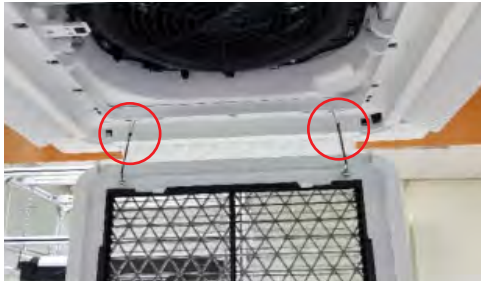

No	Parts	Procedure	Remark
		4) Disassemble the Evap. - Unscrew 3 screws. Then pull the Evap out	
4	Cushion	1) Pull out the Cushion. 2) Disassemble the Seal Cushion LF. - Unscrew 1 screws 3) Disassemble the Assy Cushion Right. - Unscrew 1 screws	  

No	Parts	Procedure	Remark
5	Case Blower & Bracket Motor	1) Disassemble the both of Case Blower Out. - Unscrew 4 screws 2) Disassemble the Bracket Motor. - Unscrew 6 screws	
6	Control	1) Disassemble the Case Control. - Unscrew 2 screws	
7	Frame	1) Disassemble the Frame. - Unscrew 6 screws	

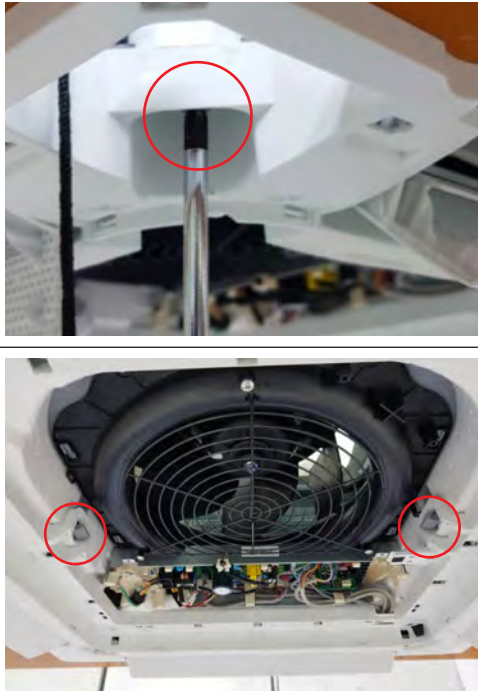
■ AC026RNNDKG , AC035RNNDKG, AC052RNNDKG, AC071RNNDKG



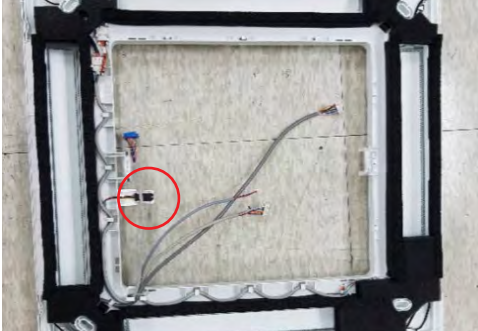
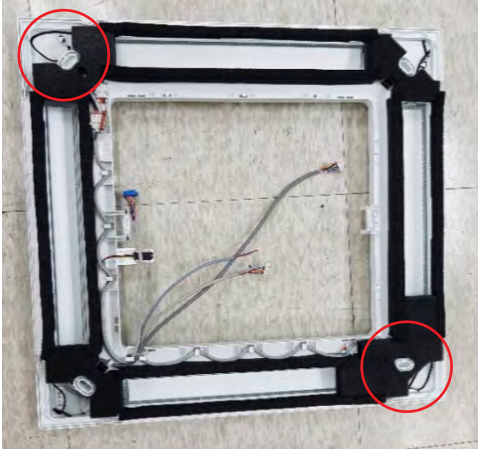

No	Parts	Procedure	Remark
1	Panel	<p>1) Pull both hooks and take the grille downward. Two safety clips are mounted to the front grille to prevent it from dropping.</p> <p>2) Detach the safety clip and take up the grille.</p> <p>3) Remove the 2 fixed screws to remove the Control-Box Cover. (Use +Screw Driver)</p> <p>4) Remove the remote control-receiver, blade conector and humidity sensor wires from the PBA. (4EA)</p> <p>5) Push the 4 panel corners and cover downwards to remove it.</p>	    

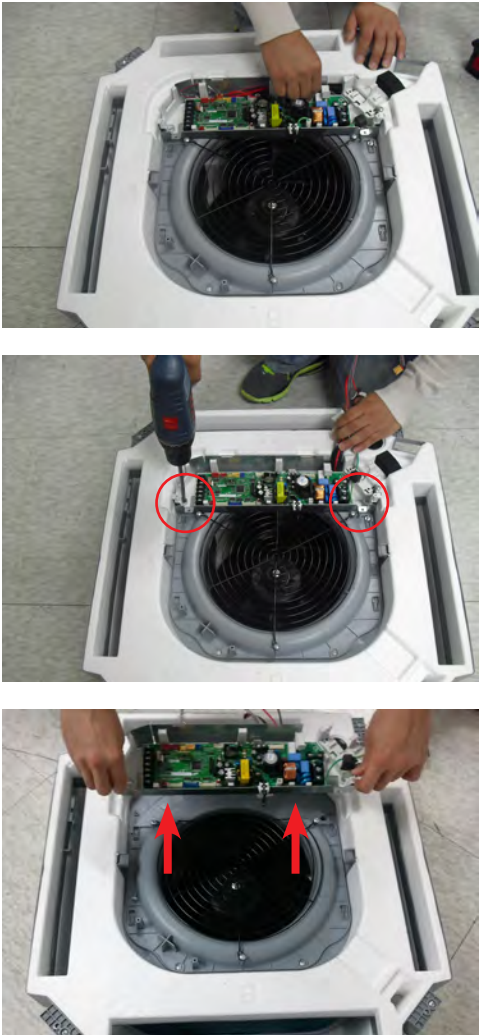

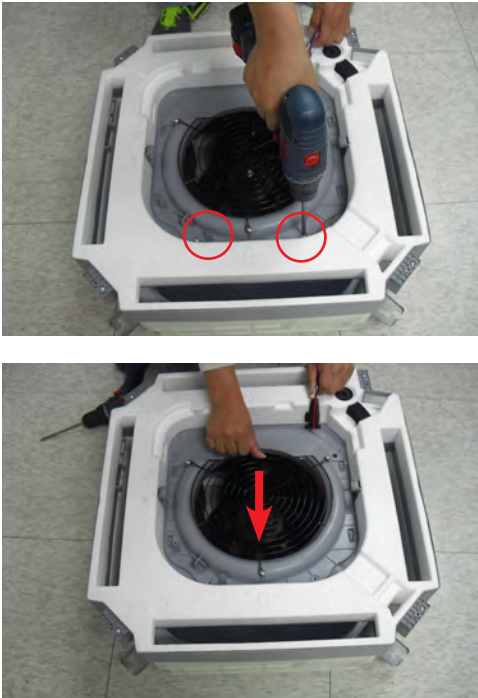
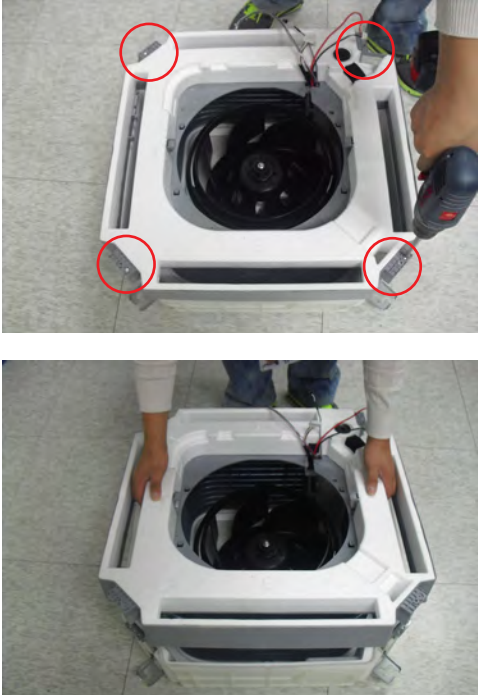
No	Parts	Procedure	Remark
		<p>6) Disassemble the bolts that are assembled with the indoor unit at the 4 panel corners.</p> <p>7) Press the Hangers at both sides of the panel inwards, to remove it from the indoor unit's hook. Remove the panel from the indoor unit.</p>	
2	Blade	1) Remove the hinge-blade and blade.	
3	Display PBA	<p>1) Remove the cover display.</p> <p>2) Remove the cover PBA from the cover display.</p>	

No	Parts	Procedure	Remark
		3) Disconnect the connector wire from the PBA.	
4	Humidity Sensor	1) Remove the humidity sensor from the panel.	
5	Step motor	1) Unscrew 2 screws on cover motor. (Use +Screw Driver) 2) Remove 2 cover motor. 3) Remove the 2 fixed screws and disassemble the step motor. (Use +Screw Driver)	 

No	Parts	Procedure	Remark
6	Control-Box	<p>1) Disconnect the Connector Wire that is connected to the indoor unit's PBA.</p> <p>2) Unscrew the 2 fixed screws on both sides of the Control Box, and disassemble the Control Box from the indoor unit. (Use +Screw Driver)</p>	

No	Parts	Procedure	Remark
7	Bell-Mouth	<p>1) Unscrew the screw fixed on the Bell-Mouth. (Use +Screw Driver)</p> <p>2) Push the Bell-Mouth in the direction opposite to where it's installed on the Control-Box to remove it.</p>	
8	Drain Pan	<p>1) Unscrew the screws on the 4 corners of the indoor unit. (Use +Screw Driver)</p> <p>2) Remove the Drain Pan from the indoor unit.</p>	

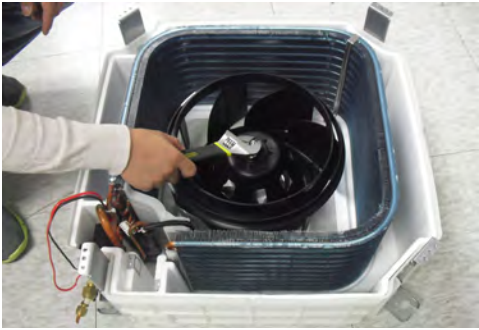
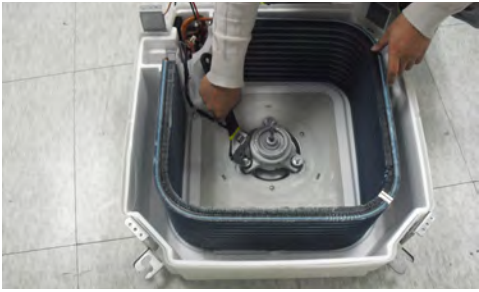
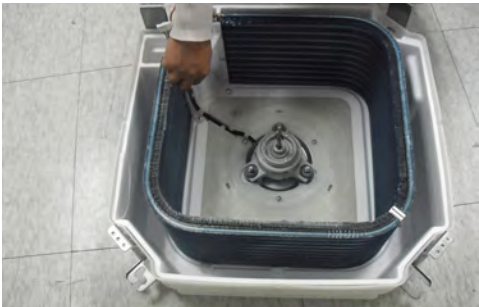
No	Parts	Procedure	Remark
9	Drain Pump & Hose	<p>1) Remove the 2 fixed screws and disconnect the white drainage hose from the Drain Pump. (Use +Screw Driver)</p> <p>2) Remove the 2 screws and take the Drain-Hose out from the indoor unit to disassemble the transparent Drain-Hose fixed on the side of the indoor unit. (Use +Screw Driver)</p>	  
10	Evap. Temperature Sensor	<p>1) Use your hand to remove the temperature sensor attached to the Evap Pipe along with the fixing clip.</p>	

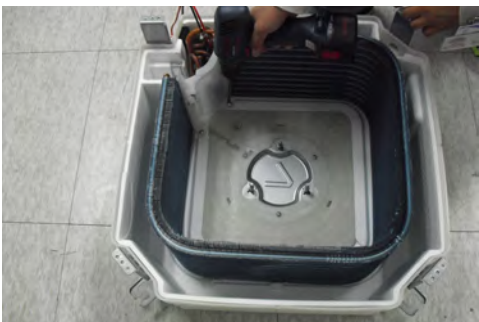
No	Parts	Procedure	Remark
11	Fan & Motor	<p>1) Turn the hexangular nut attached to the top of the Fan counterclockwise to remove it. Take the Fan out of the Motor.</p> <p>2) Turn the three hexangular nuts on the Motor counterclockwise to remove the nuts. Take the Motor Wires attached to these three locations out with your hands prior to removing the Motor.</p>	  
12	Evaporator	<p>1) Remove the screws of the Steel Holder Evaps that are used to fix the Heat Exchanger, and then remove it. (Use +Screw Driver)</p> <p>2) Remove the 2 fixing screws of the Partition Evap at the Heat Exchanger's In/Out Pipe. (Use +Screw Driver)</p>	 

No	Parts	Procedure	Remark
		<p>3) Remove the screw of the Cover Pipe that is used to fix the In/Out Pipe. Remove the In/Out Pipe. (Use +Screw Driver)</p> <p>4) Remove the Heat Exchanger from the indoor unit's cabinet.</p>	  

3-2 Outdoor unit

■ AC026RXADKG / AC035RXADKG

No	Parts	Procedure	Remark
1	common work	<p>⚠ You must turn off the Power before disassembly.</p> <p>1) loosen 1 pcs screw of cover control, and detach it.</p> <p>2) loosen 5 pcs screws on both right and left cabinet side edges and to detach the cover-top.</p> <p>3) Loosen 7 screws fixed to disassemble cabi-front, and detach it.</p>	   

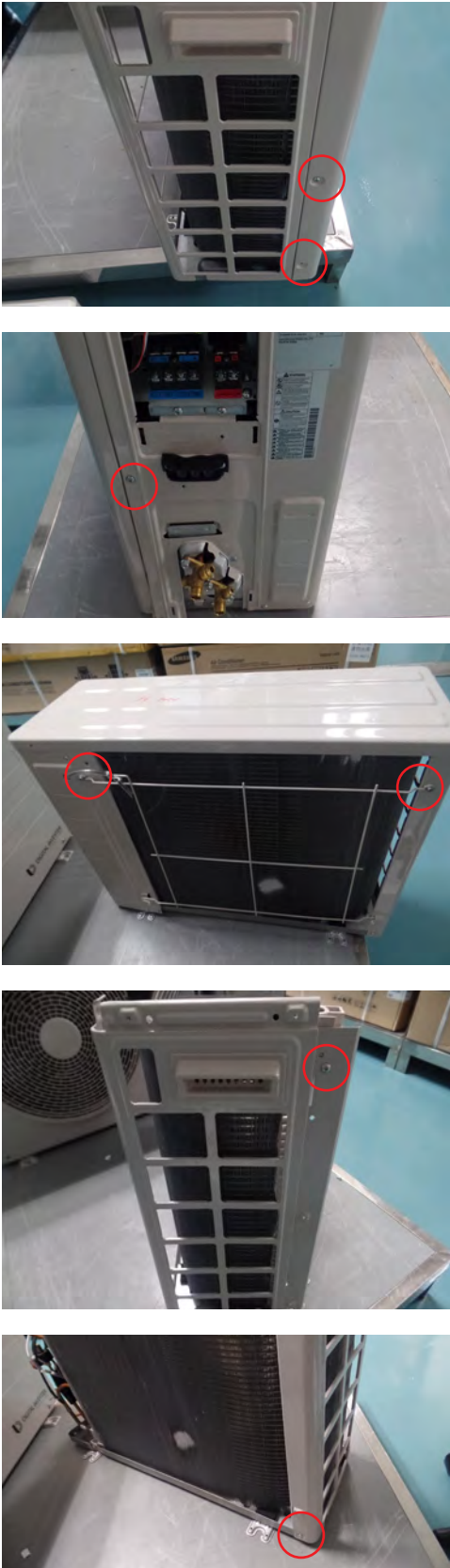

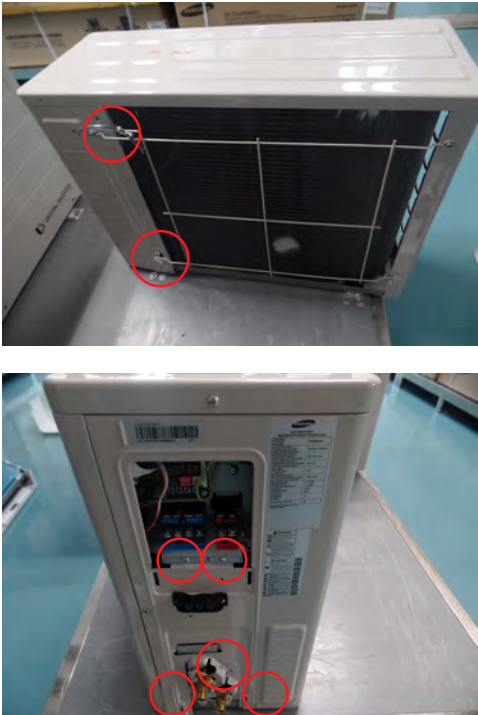
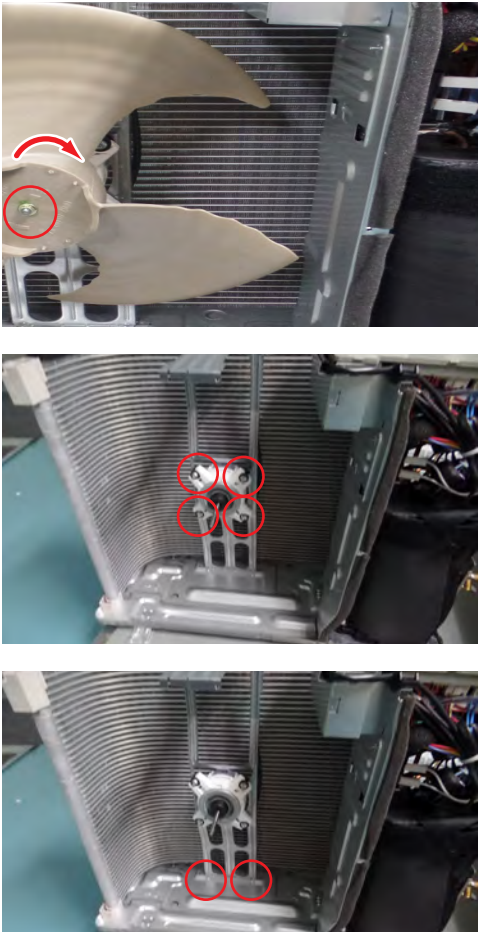

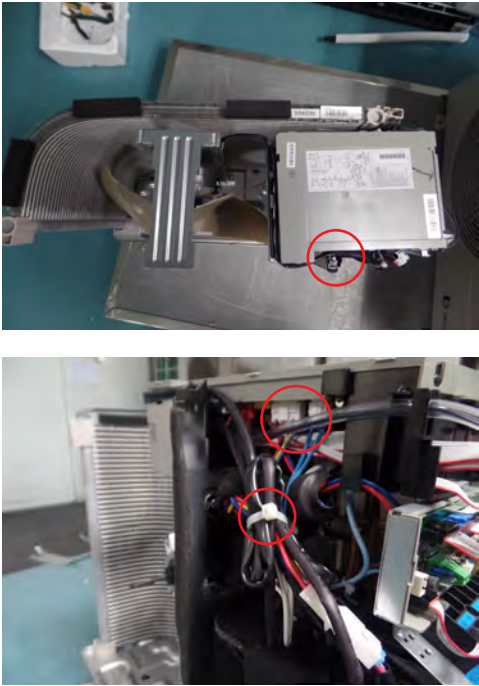
No	Parts	Procedure	Remark
	common work	<p>4) loosen 2 screws to disassemble steel-bar.</p> <p>5) Loosen 2 screws to disassemble the cabi left and detach it.</p>	 <p>The 'Remark' column contains four photographs illustrating the disassembly process. The first photo shows the top of the device with two screws on the right side circled in red. The second photo shows the interior of the device with a screw on the left side circled in red. The third photo shows the front of the device with two screws on the left side of the cabinet circled in red. The fourth photo shows the front of the device with a screw on the right side of the cabinet circled in red.</p>

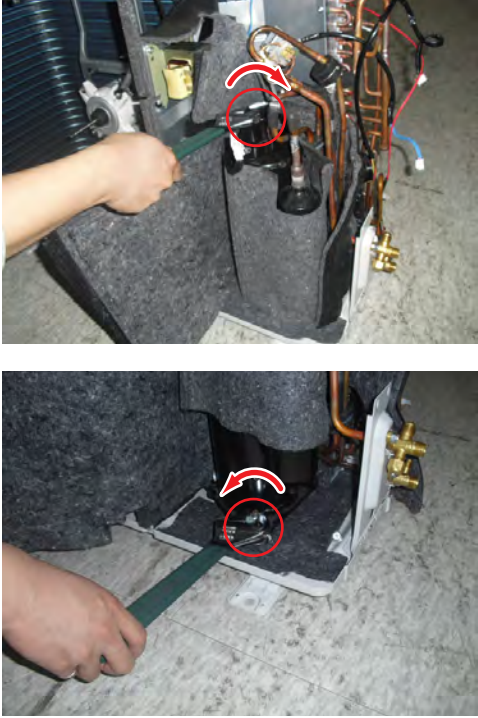
No	Parts	Procedure	Remark
	common work	6) Loosen 7 screws to disassemble the cabi right and detach it.	
2	fan & motor	<p>1) loosen 1 screw as indication and detached the fan.</p> <p>2) loosen 4 pcs motor screws and disconnect the wire between assy control out and motor.</p> <p>3) loosen 2 pcs bracket-motor screw and detach it.</p>	



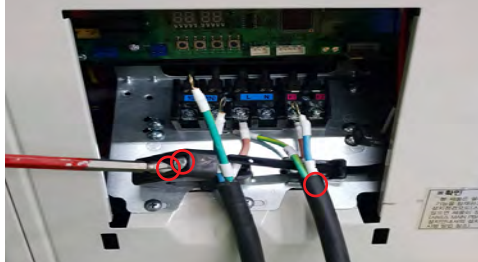

No	Parts	Procedure	Remark
3	assy control out	<p>1) Disconnect fixing 1 screw from cover. - control</p> <p>2) detach several connections from assy control out, take out assy control out.</p>	
4	Heat exchanger	<p>1) Release the refrigerant at first</p> <p>2) Loosen fixing screw on both side.</p> <p>3) disassembly the pipes in both inlet and outlet with welding torch.</p> <p>4) detach the heat exchanger.</p>	

No	Parts	Procedure	Remark
5	compressor	<p>1) disconnect the compressor lead wire.</p> <p>2) disassembly the felt comp sound. loosen the 3 bolts at the bottom.</p> <p>⚠ When removing the compressor, Heat Exchanger, and Pipe, purge the refrigerant inside the Compressor completely and remove the pipe with a welding flame.</p>	

■ AC052RXADKG

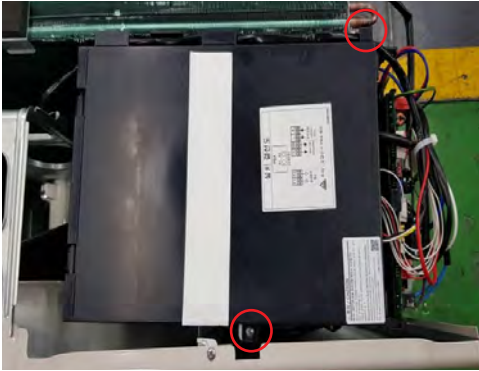

No	Parts	Procedure	Remark
1	Cabi Top	1) Unscrew and remove 8 screws on each side of the Cabinet-Top. (Use + Screw Driver)	
2	ASS'Y COVER CONTROL	1) Unscrew and remove a screw of Cover-Control. (Use + Screw Driver)	
3	Outdoor and indoor unit's power cable and communication cable	<p>⚠ Make sure shutting the power off supply before disassembling</p> <p>1) Unscrew 2 fix screws under cable holders and remove.</p> <p>2) Get rid of cable tie of communication cable.</p> <p>3) Unscrew the numbers of screws on terminal block and separate power and communication 'Ring'cables from terminal block.</p>	 

No	Parts	Procedure	Remark
4	ASS'Y CABINET SIDE RH	1) Unscrew and remove 9 screws on Cabinet-side rh. (Use + Screw Driver)	
5	ASS'Y CABINET FRONT	1) Unscrew and remove 8 screws on Assy Cabinet Front. (Use + Screw Driver)	

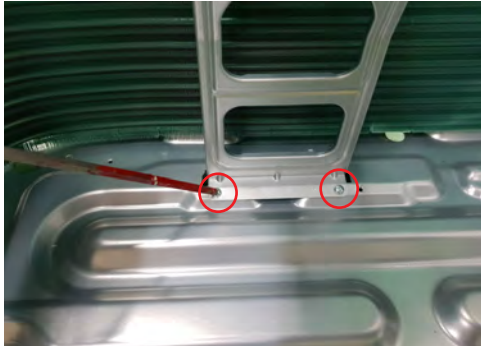
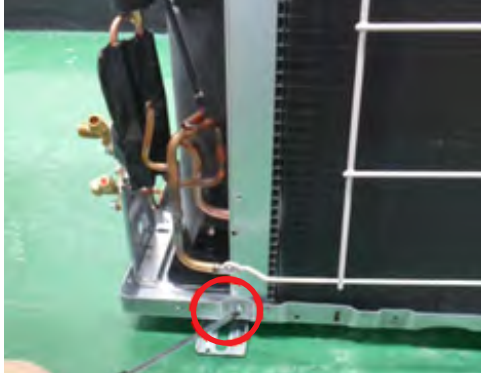

No	Parts	Procedure	Remark
6	ASS'Y CONTROL OUT	<p>1) Disconnect and Separate 5 Connectors of wire from Assy Control Out.</p> <p>2) Separate Comp wire and Reactor wire from each object.</p> <p>⚠ (When you disconnect BLDC motor connector you have to cut the power off first and disconnect 30 seconds later And Make sure that is impossible to connect and disconnect BLDC motor connector when the power is on)</p> <p>3) Unscrew and remove 2 screws on of Assy Control out.</p>	  
7	FAN PROPELLER + MOTOR	<p>1) Take Fan Propeller apart.</p> <p>2) Unscrew and remove 4 screws on Motor to take apart Motor. (Use + Screw Driver)</p>	 

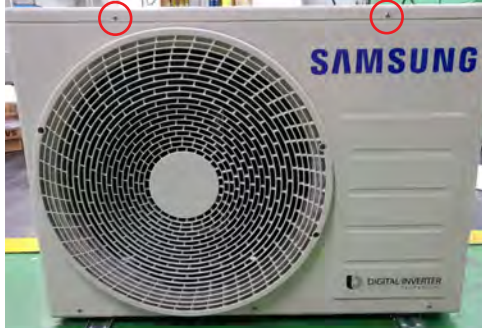
No	Parts	Procedure	Remark
8	ASS'Y BRACKET MOTOR	1) Unscrew and remove 2 screws on to take apart Bracket Motor. (Use + Screw Driver)	
9	Heat Exchanger	1) Purge the Refrigerant first. 2) Unscrew the fix screw. 3) Separate the pipe from the Entrance and Exist by using a welder. 4) Separate Heat Exchanger from Unit. ⚠ When removing the Compressor, Heat Exchanger, and Pipe, Purge the Refrigerant inside the Compressor completely and remove the pipe with a weld-ing flame.	

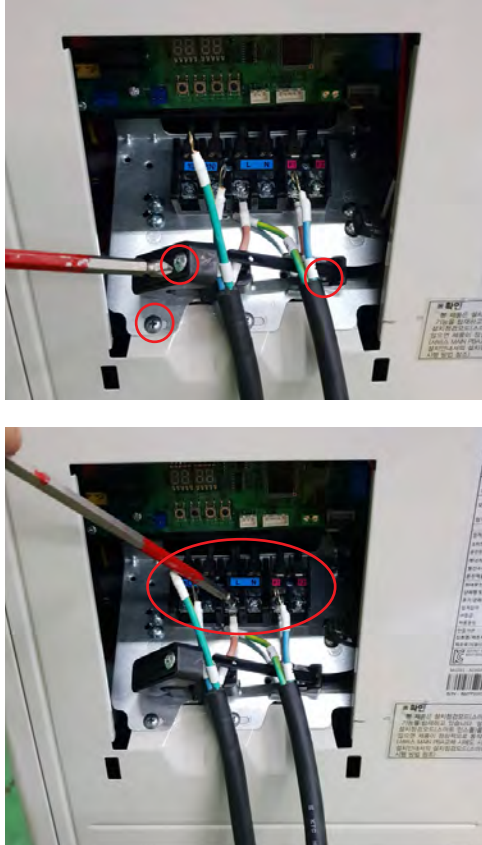
■ AC071RXADKG

No	Parts	Procedure	Remark
1	Cabi Top	1) Unscrew and remove 8 screws on each side of the Cabinet-Top. (Use + Screw Driver)	
2	Ass'y cover control	1) Unscrew and remove a screw of Cover-Control. (Use + Screw Driver)	
3	Outdoor and indoor unit's power cable and communication cable	<p>⚠ Make sure shutting the power off supply before disassembling.</p> <p>1) Unscrew 2 fix screws under cable holders and remove.</p> <p>2) Get rid of cable tie of communication cable.</p> <p>3) Unscrew the numbers of screws on terminal block and separate power and communication 'Ring' cables from terminal block.</p>	

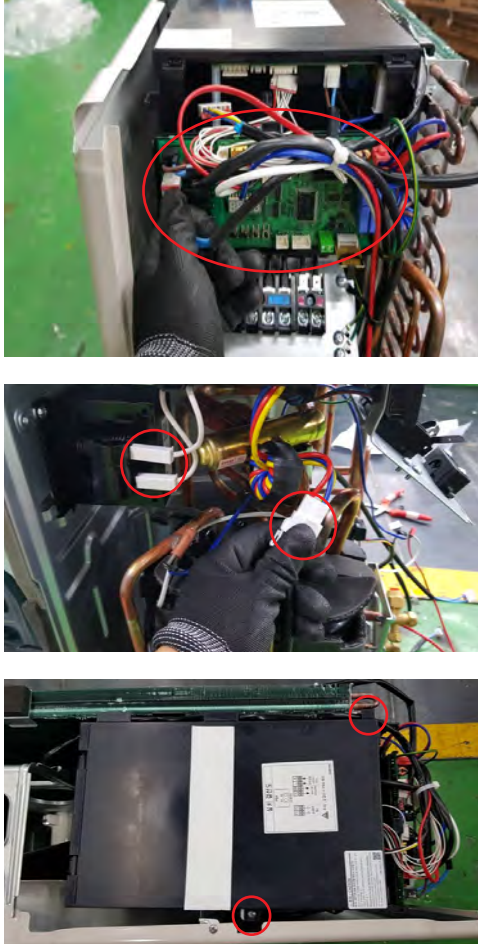
No	Parts	Procedure	Remark
4	Ass'y cabinet side rh	1) Unscrew and remove 10 screws on Cabinet-side rh. (Use + Screw Driver)	
5	Ass'y cabinet front	1) Unscrew and remove 7 screws on Assy Cabinet Front. (Use + Screw Driver)	

No	Parts	Procedure	Remark
6	Ass'y control out	<p>1) Disconnect and Separate 5 Connectors of wire from Assy Control Out.</p> <p>2) Separate Comp wire and Reactor wire from each object.</p> <p>⚠ (When you disconnect BLDC motor connector you have to cut the power off first and disconnect 30 seconds later And Make sure that is impossible to connect and disconnect BLDC motor connector when the power is on)</p> <p>3) Unscrew and remove 2 screws on of Assy Control out.</p>	
7	Fan propeller + Motor	<p>1) Take Fan Propeller apart.</p> <p>2) Unscrew and remove 4 screws on Motor to take apart Motor. (Use + Screw Driver)</p>	

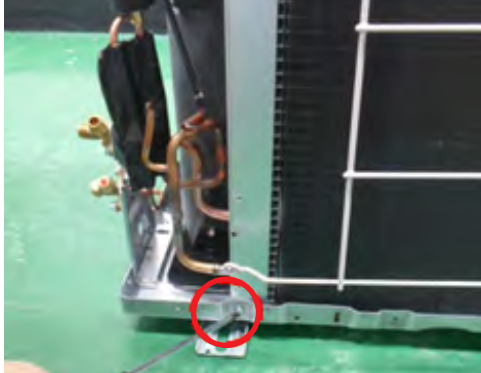
No	Parts	Procedure	Remark
8	Ass'y bracket Motor	1) Unscrew and remove 2 screws on to take apart Bracket Motor. (Use + Screw Driver)	
9	Heat Exchanger	1) Purge the Refrigerant first. 2) Unscrew the fix screw. 3) Separate the pipe from the Entrance and Exist by using a welder. 4) Separate Heat Exchanger from Unit. ⚠ When removing the Compressor, Heat Exchanger, and Pipe, Purge the Refrigerant inside the Compressor completely and remove the pipe with a weld-ing flame.	

🔗 Reassembly procedures are in the reverse order of disassembly procedures.

4. Troubleshooting

4-1 Setting an indoor unit address and installation option

► Set the indoor unit address and installation option with remote controller option.

Set the each option separately since you cannot set the ADDRESS setting and indoor unit installation setting option at the same time. You need to set twice when setting indoor unit address and installation option.

4-1-1 The procedure of setting option

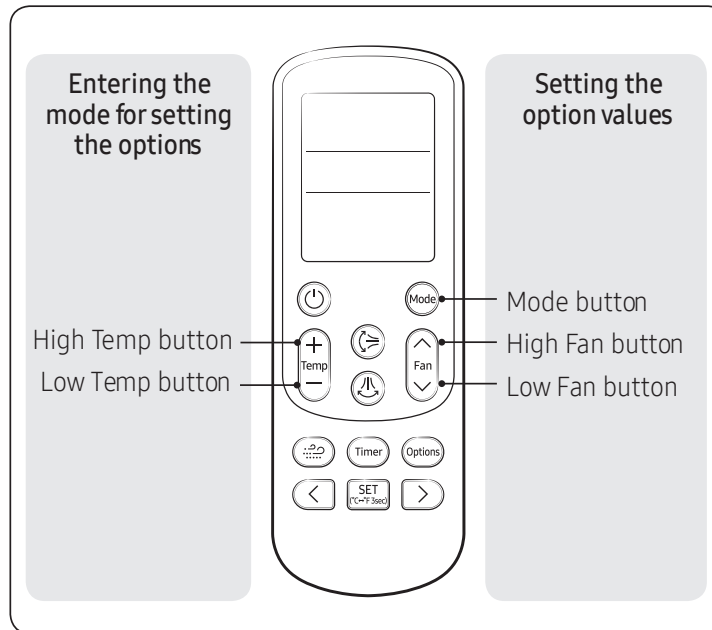

Step 1 Entering mode for option setting.

1. Remove batteries from the remote controller.
2. Insert the batteries while you press [+ Temperature] and [- Temperature] button at the same time.
3. Check if you have entered the option setting status. 

Step 2 Option setting procedure. (The option setting procedure is the same for other models.)

After entering the option setting status, select the option as listed below.





- Option setting is available from SEG1 to SEG 24.
- SEG1, SEG7, SEG13, SEG19 are not set as page option.
- Set the SEG2~SEG6, SEG8~SEG12 in the ON status and SEG14~18, SEG20~24 in the OFF status.

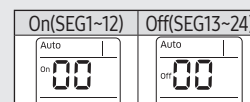



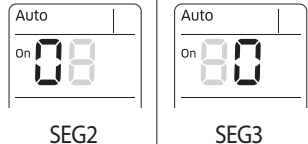
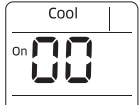
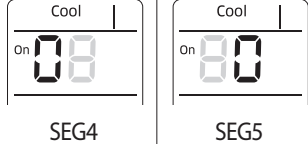

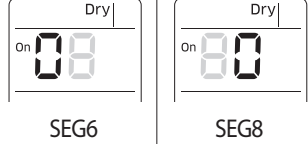
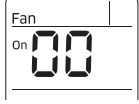
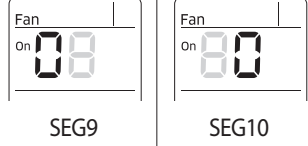
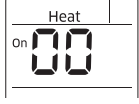
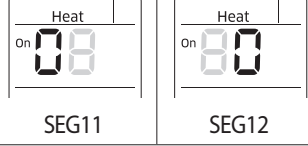
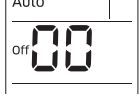
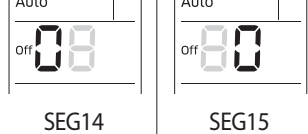



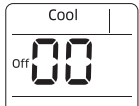



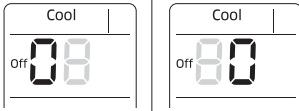

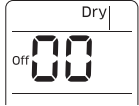



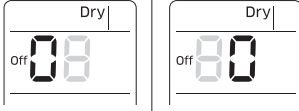

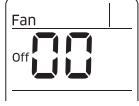
SEG1	SEG2	SEG3	SEG4	SEG5	SEG6	SEG7	SEG8	SEG9	SEG10	SEG11	SEG12
0	X	X	X	X	X	1	X	X	X	X	X
SEG13	SEG14	SEG15	SEG16	SEG17	SEG18	SEG19	SEG20	SEG21	SEG22	SEG23	SEG24
2	X	X	X	X	X	3	X	X	X	X	X

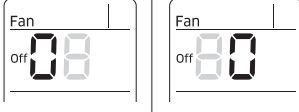

4-1-2 The procedure of setting option

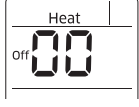
Option setting	Status
<p>1. Setting SEG2, SEG3 option Press Low Fan button(∨) to enter SEG2 value . Press High Fan button(∧) to enter SEG3 value . Each time you press the button, → → ... → will be selected in rotation .</p>	
<p>2. Setting Cool mode Press Mode button to be changed to Cool mode in the ON status .</p>	
<p>3. Setting SEG4, SEG5 option Press Low Fan button(∨) to enter SEG4 value . Press High Fan button(∧) to enter SEG5 value . Each time you press the button, → → ... → will be selected in rotation .</p>	
<p>4. Setting Dry mode Press Mode button to be changed to DRY mode in the ON status .</p>	
<p>5. Setting SEG6, SEG8 option Press Low Fan button(∨) to enter SEG6 value . Press High Fan button(∧) to enter SEG8 value . Each time you press the button, → → ... → will be selected in rotation .</p>	
<p>6. Setting Fan mode Press Mode button to be changed to FAN mode in the ON status .</p>	
<p>7. Setting SEG9, SEG10 option Press Low Fan button(∨) to enter SEG9 value . Press High Fan button(∧) to enter SEG10 value . Each time you press the button, → → ... → will be selected in rotation .</p>	
<p>8. Setting Heat mode Press Mode button to be changed to HEAT mode in the ON status .</p>	
<p>9. Setting SEG11, SEG12 option Press Low Fan button(∨) to enter SEG11 value . Press High Fan button(∧) to enter SEG12 value . Each time you press the button, → → ... → will be selected in rotation .</p>	
<p>10. Setting Auto mode Press Mode button to be changed to AUTO mode in the OFF status.</p>	
<p>11. Setting SEG14, SEG15 option Press Low Fan button(∨) to enter SEG14 value . Press High Fan button(∧) to enter SEG15 value . Each time you press the button, → → ... → will be selected in rotation.</p>	

The procedure of setting option (cont.)

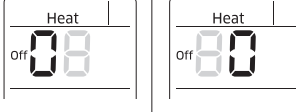
Option setting	Status
<p>12. Setting Cool mode</p> <p> Press Mode button to be change to Cool mode in the OFF status.</p>	
<p>13. Setting SEG16, SEG17 option</p> <p>Press Low Fan button(∨) to enter SEG16 value.</p> <p>Press High Fan button(∧) to enter SEG17 value.</p> <p>Each time you press the button,  →  → ...  →  will be selected in rotation.</p>	 <p style="text-align: center;">SEG16 SEG17</p>
<p>14. Setting Dry mode</p> <p> Press Mode button to be change to Dry mode in the OFF status.</p>	
<p>15. Setting SEG18, SEG20 option</p> <p>Press Low Fan button(∨) to enter SEG18 value.</p> <p>Press High Fan button(∧) to enter SEG20 value.</p> <p>Each time you press the button,  →  → ...  →  will be selected in rotation.</p>	 <p style="text-align: center;">SEG18 SEG20</p>
<p>16. Setting Fan mode</p> <p> Press Mode button to be change to Fan mode in the OFF status.</p>	
<p>17. Setting SEG21, SEG22 option</p> <p>Press Low Fan button(∨) to enter SEG21 value.</p> <p>Press High Fan button(∧) to enter SEG22 value.</p> <p>Each time you press the button,  →  → ...  →  will be selected in rotation.</p>	 <p style="text-align: center;">SEG21 SEG22</p>
<p>18. Setting Heat mode</p> <p> Press Mode button to be change to HEAT mode in the OFF status.</p>	
<p>19. Setting SEG23, SEG24 mode</p> <p>Press Low Fan button(∨) to enter SEG23 value.</p> <p>Press High Fan button(∧) to enter SEG24 value.</p> <p>Each time you press the button,  →  → ...  →  will be selected in rotation.</p>	 <p style="text-align: center;">SEG23 SEG24</p>

Step 3 Check the option you have set

After setting option, press  button to check whether the option code you input is correct or not.

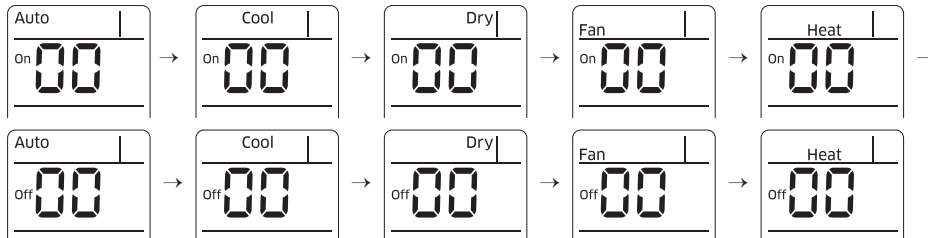

Step 4 Input option

Press the operation button  with the direction of remote control for set.

For the correct option setting, you must input the option twice.

Step 5 Check operation

- 1) Reset the indoor unit by pressing the RESET button of indoor unit or outdoor unit.
- 2) Take the batteries out of the remote controller and insert them again and then press the operation button.

4-1-3 Order for Setting Options (Wired Remote Controller)

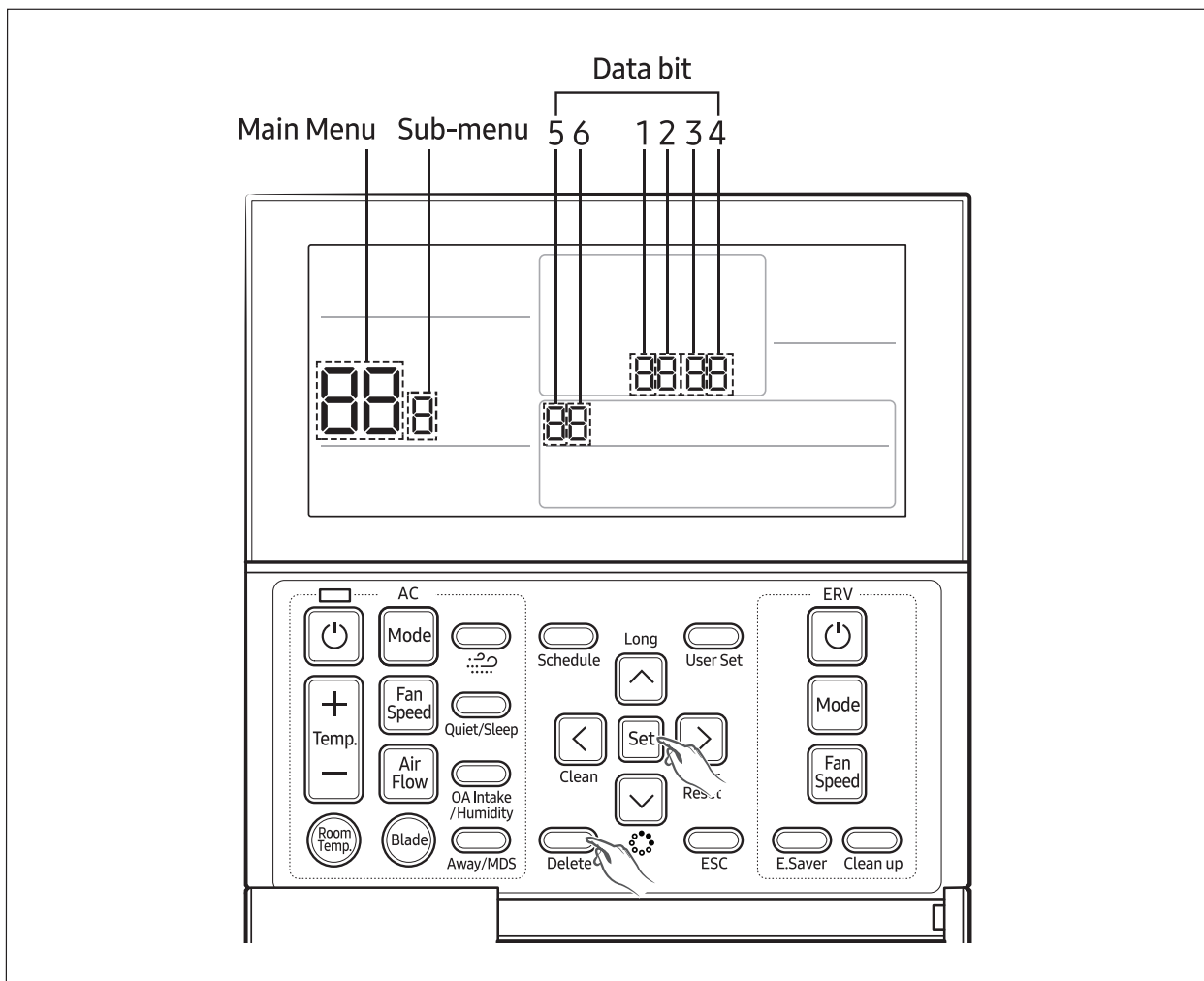

1. If you want to use the various additional functions for your Wired Remote Controller, press the set and delete buttons at the same time for more than three seconds.
 - ▶ You will enter the additional function settings, and the [main menu] will be displayed.
2. Refer to the list of additional functions for your Wired Remote Controller on the next page, and select the desired menu.
 - ▶ Using the [^]/[v] buttons, select a main menu number and press the [>] button to enter the sub-menu setting screen.
 - ▶ Using the [^]/[v] buttons, select a sub-menu number and press the [>] button to enter data setting screen.
 - ▶ When you enter the setting stage, the current setting will be displayed.
 - ▶ Refer to the chart for data settings.
 - ▶ Using the [^]/[v] buttons, select the settings. Press the [>] button to move to the next setting.
 - ▶ Press the **Set** button to save the settings and exit to the sub-menu setting screen.
 - ▶ Press the **Esc** button to exit to normal mode.



- While setting the data, you can use the [<]/[>] buttons to set the range of Data bit.
- While configuring the setting, press the **Esc** button to exit to the setting sub-menu without saving your changes.

4-1-4 Setting an indoor unit installation option (Suitable for the condition of each installation location)

1. Check whether power is supplied or not.
 - When the indoor unit is not plugged in, there should be additional power supply in the indoor unit.
2. The panel(display) should be connected to an indoor unit to receive option.
3. Set the installation option according to the installation condition of an air conditioner.
 - The default setting of an indoor unit installation option is 02000-100000-200000-300000.
 - Individual control of a remote controller(SEG20) is the function that controls an indoor unit individually when there is more than one indoor unit.
4. Set the indoor unit option by wireless remote controller.

Option No. : 02XXXX-1XXXXX-2XXXXX-3XXXXX

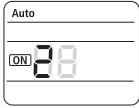
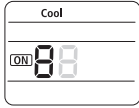
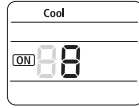
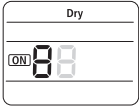
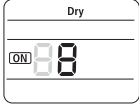
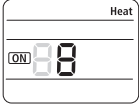
Option	SEG1		SEG2		SEG3	SEG4		SEG5		SEG6	
Explanation	PAGE		MODE		RESERVED	Use of external temperature sensor		Use of central control		Compensation of the fan RPM	
Remote Controller Display											
Indication and Details	Indication	Details	Indication	Details		Indication	Details	Indication	Details	Indication	Details
	0		2			0	Disuse	0	Disuse	0	Disuse
						1	Use	1	Use	1	High - Ceiling Mode
Option	SEG7		SEG8		SEG9	SEG10		SEG11		SEG12	
Explanation	PAGE		Use of drain pump		RESERVED	RESERVED		RESERVED		Dew removal operation in Wind-Free mode	
Remote Controller Display											
Indication and Details	Indication	Details	Indication	Details						Indication	Details
	1		0	Disuse					0	Maintain blade status in Wind-Free mode	
			1	Use							
			2	Use + 3minute delay					1	(Default) Cooling Operation by Opening the bla	

Option No. : 02XXXX-1XXXX-2XXXX-3XXXX

Option	SEG13		SEG14		SEG15		SEG16		SEG17		SEG18	
Explanation	PAGE		Use of external control		Setting the output of external control		S-Plasma ion		Buzzer control		Number of hours using filter	
Remote Controller Display												
Indication and Details	Indication	Details	Indication	Details	Indication	Details	Indication	Details	Indication	Details	Indication	Details
	2		0	Disuse	0	Thermo on	0	Disuse	0	Use of buzzer	2	1000 Hour
		1	ON/OFF Control	1	Operation on	1	Use	1	Non use of buzzer	6	2000 Hour	
		2	OFF Control									
3	Window ON/OFF Control											
Option	SEG19		SEG20		SEG21		SEG22		SEG23		SEG24	
Explanation	PAGE		Individual control of a remote controller						Setting the MDS Kit installation option			
Remote Controller Display												
Indication and Details	Indication	Details	Indication	Details	RESERVED	RESERVED	Indication		Details		RESERVED	
	3		0 or 1	Indoor 1			0		Disuse (Soft Off+Hard off)			
		2	Indoor 2	Standard			1	Off after 20 min. (Soft Off+Hard off)				
		3	Indoor 3				2	Off after 40 min. (Soft Off+Hard off)				
		4	Indoor 4				3	Off after 80 min. (Soft Off+Hard off)				
	Premium	4	Off after 20 min. (Soft Off+Hard off)				Premium	4	Off after 20 min. (Soft Off+Hard off)			
		5	Off after 40 min. (Soft Off+Hard off)					5	Off after 40 min. (Soft Off+Hard off)			
		6	Off after 80 min. (Soft Off+Hard off)					6	Off after 80 min. (Soft Off+Hard off)			
	Standard	7	Off after 20 min. (Soft Off only)				Standard	7	Off after 20 min. (Soft Off only)			
		8	Off after 40 min. (Soft Off only)					8	Off after 40 min. (Soft Off only)			
		9	Off after 80 min. (Soft Off only)					9	Off after 80 min. (Soft Off only)			
	Premium	A	Off after 20 min. (Soft Off only)				Premium	A	Off after 20 min. (Soft Off only)			
		B	Off after 40 min. (Soft Off only)					B	Off after 40 min. (Soft Off only)			
C		Off after 80 min. (Soft Off only)		C	Off after 80 min. (Soft Off only)							

- Even if you set the Use of drain pump (SEG8) option to 0, it is automatically set to 2 (the drain pump is used with 3 minute delay).
- If you set the Maximum filter usage time (SEG18) option to a value other than 2 and 6, it is automatically set to 2 (1000 hours).
- If you set the Individual control with remote control (SEG20) option to a value other than 0 to 4, it is automatically set to 0 (Indoor 1).

4-1-5 Changing a particular option

You can change each digit of set option.

Option	SEG1		SEG2		SEG3		SEG4		SEG5		SEG6	
Explanation	PAGE		MODE		The option mode you want to change		The tens' digit of an option SEG you will change		The unit digit of an option SEG you will change		The changed value	
Remote Controller Display												
Indication and Details	Indication	Details	Indication	Details	Indication	Details	Indication	Details	Indication	Details	Indication	Details
	0		D		Option mode	0~F	Tens' digit of SEG	0~9	Unit digit of SEG	0~9	The changed value	0~F



- When changing a digit of an indoor unit address setting option, set the SEG3 as 'A'.
- When changing a digit of indoor unit installation option, set the SEG3 as '2'.

Option	SEG1	SEG2	SEG3	SEG4	SEG5	SEG6
Explanation	PAGE	MODE	The option mode you want to change	The tens' digit of an option SEG you will change	The unit digit of an option SEG you will change	The changed value
Indication	0	D	2	1	7	1

Ex) When setting the 'buzzer control' into disuse status.

4-1-6 Option code for each model

AC026RN1DKG	01717C-1930F8-271A21-371120
AC035RN1DKG	01717C-19344D-272328-371120
AC026RNNDKG	01517F-1910C8-271A22-370000
AC035RNNDKG	01517F-1930F9-272328-370000
AC052RNNDKG	01517F-19345D-27343C-370040
AC071RNNDKG	01517F-194581-274750-370040
AC052RN4DKG	01417F-1940A8-27343C-370000
AC071RN4DKG	01417F-1940C8-274750-370000
AC071RN4PKG	01017F-1940D8-274750-370000
AC026RNLDKG	01C17C-1C1914-271A21-370000
AC035RNLDKG	01C17C-1C3936-272328-370000
AC052RNLDKG	01C17C-1C1924-27343C-370000
AC071RNLDKG	01C17C-1C59D0-274750-370005
AC035RNMDKG	01B17C-1C5080-272328-372008
AC052RNMDKG	01B17C-1C50F1-27343C-374000
AC071RNMDKG	01B17C-1C5436-274750-376000
AC026RNADKG	01017F-191448-271A21-371200
AC035RNADKG	01017F-19548C-272328-371700
AC052RNADKG	01017F-19548E-27343C-371700
AC071RNADKG	01017F-19547F-274750-371700
AC052RNCDKG	01317F-1950F5-27343C-370000
AC071RNCDKG	01317F-195591-274750-370020

4-2 Items to check before diagnostics

4-2-1 Test run mode and View mode

■ Display Option Key

KEY	Key Operation		Key Operation	7-segment Display			
K1	Short	1st	Heating test mode	H	1	8	8
		2nd	Defrost test mode*	H	3	8	8
		3rd	Stop	8	8	8	8
K2	Short	1st	Cooling test	H	2	8	8
		2nd	Inverter check	H	4	8	8
		3rd	Pump down	H	6	8	8
		4th	Stop	8	8	8	8
K3	Short	1st	Reset Release Eco mode	8	8	8	8



■ View mode display

※ Press the K4 switch to view the information on the system status as follows:

K4 short push	Display contents	SEG1	SEG2	SEG3	SEG4	Unit
1	Order frequency	1	Hundreds digit	Tens digits	Units digit	Hz
2	Current frequency	2	Hundreds digit	Tens digits	Units digit	Hz
3	The number of preset indoor units	3	Hundreds digit	Tens digits	Units digit	Unit
4	Ambient temperature sensor	4	+/-	Tens digits	Units digit	°C
5	Compressor discharge sensor	5	Hundreds digit	Tens digits	Units digit	°C
6	Eva Sensor	6	+/-	Tens digits	Units digit	°C
7	Condenser sensor	7	+/-	Tens digits	Units digit	°C
8	Current	8	Tens digits	Units digit	The first place of decimals	°C
9	Outdoor fan RPM	9	Thousands digit	Hundreds digit	Tens digits	rpm
10	Target discharge temperature	A	Hundreds digit	Tens digits	Units digit	°C
11	EEV	B	Hundreds digit	Tens digits	Units digit	step
12	The capacity sum of indoor units	C	Tens digits	Units digit	The first place of decimals	kW
13	Protective control	D	0: Cooling 1: Heating	Protective control 0: No Protective control 1: Freezing 2: Non-stop defrosting 3: Over-load 4: Discharge 5: Total electric current	Frequency status 0: Normal 1: Hold 2: Down 3: Up_limit 4: Down_limit	-
14	IPM temperature	E	Hundreds digit	Tens digits	Units digit	-
15	The number of connected indoor units	F	0	Tens digits	Units digit	EA

■ Setting outdoor unit option switch and address manually

▶ Setting the option

- Press and hold K2 to enter the option setting.
(Only available when the operation is stopped)
- If you enter the option setting, display will show the following.

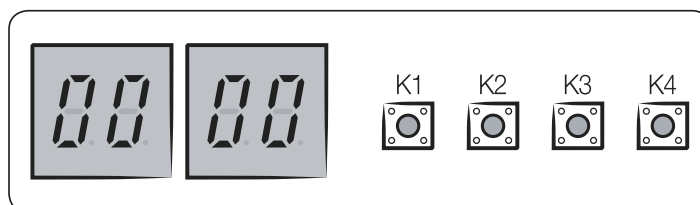

- Seg 1 and Seg 2 will display the number for selected option.
- Seg 3 and Seg 4 will display the number for set value of the selected option.
- If you have selected desired option, you can shortly press the K2 switch to adjust the value of the Seg 3, Seg 4 and change the function for the selected option

Example)

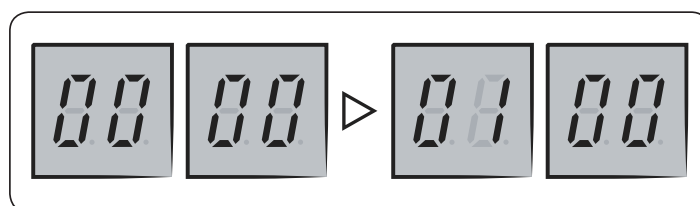

- If you have selected desired option, you can shortly press the K2 switch to adjust the value of the Seg 3, Seg 4 and change the function for the selected option.

Example)

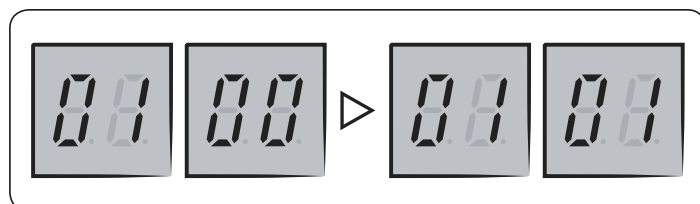

- After selecting the function for options, press and hold the K2 switch for 2 seconds. Edited value of the option will be saved when entire segments blinks and tracking mode begins.

Option item	Input unit	SEG1	SEG2	SEG3	SEG4	Function
Channel address	Main	0	0	A	U	Automatic setting (Factory default)
				00 ~ 15		manual setting
Snow accumulation prevention control	Main	0	1	0	0	Disabled (Factory default)
				0	1	Enabled
Step for Silence mode	Main	0	2	0	0	Disabled (Factory default)
				0	1	Step1
				0	2	Step2
				0	3	Step3
Type of Silence mode	Main	0	3	0	0	Automatic Silence mode (Factory default)
				0	1	Manual Silence mode

-  Edited option will not be saved if you do not end the option setting as explained in above instruction.
- While you are setting the option, you may press and hold the K1 button to reset the value to previous setting.
 - If you want to restore the setting to factory default, press and hold the K4 button while you are in the option setting mode.
 - If you press and hold the K4 button, setting will be restored to factory default but it doesn't mean that restored setting is saved. Press and hold the K2 button. When the segments shows that tracking mode is in progress, setting will be saved.

4-2-2 Eco Mode [Power Saving Mode]

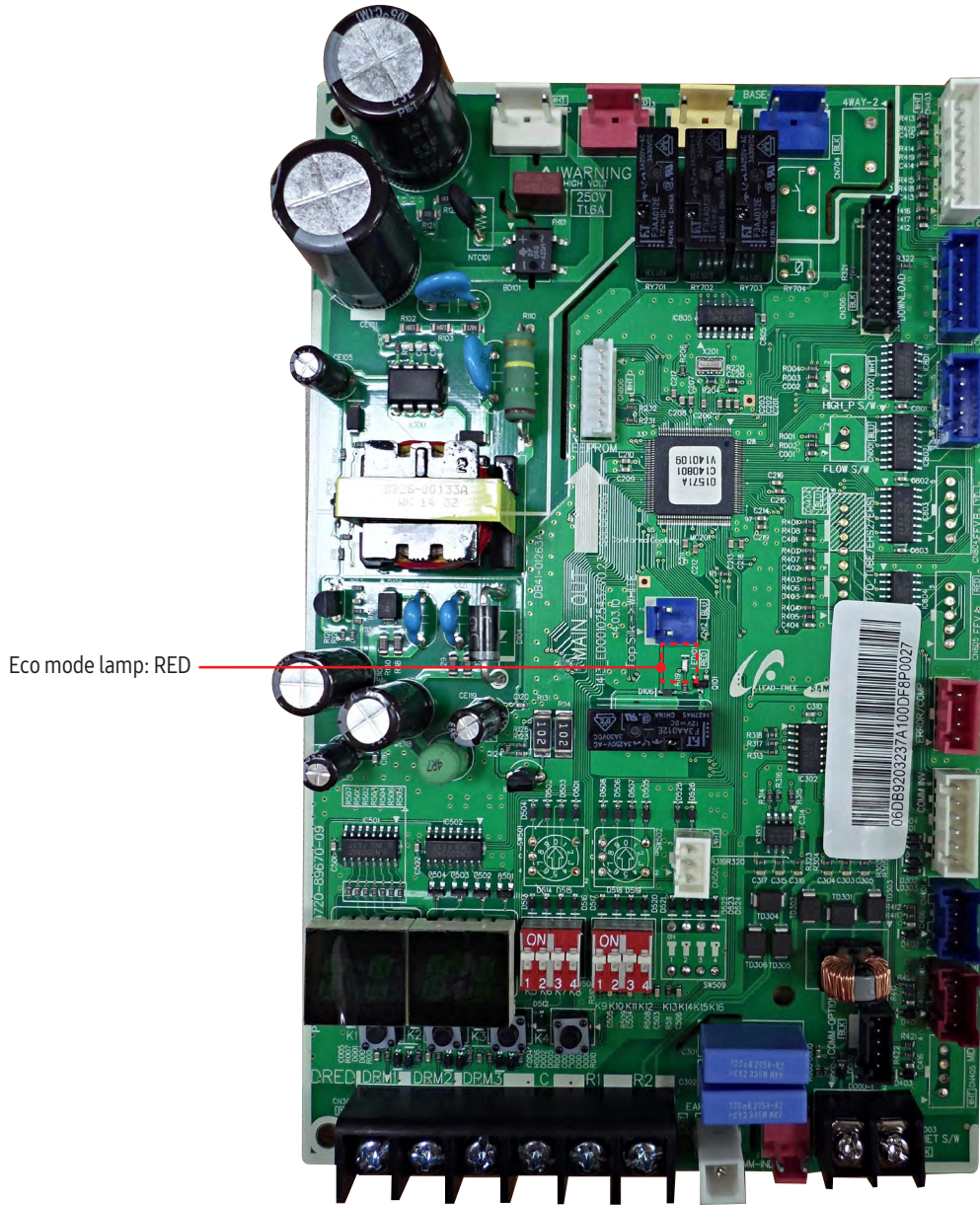

Mode	Display				Eco Mode Lamp
	Segment 1	Segment 2	Segment 3	Segment 4	
Eco Mode	BLANK	BLANK	BLANK	BLANK	On
Eco Mode Exit	Press K3 to go out from the eco mode. At the driving signal or test run (cooling/heating) of the user, the mode is released.				Off

4-2-3 Four directions cassette type

Error Mode				Cause	Measures	Product operation with error			Diagnosis method
Operation	Defrost	Timer	Filter			Outdoor heat exchanger compressor	Outdoor heat exchanger fan	Indoor heat exchanger fan	
●	X	X	X	Power reset	-	Operation-off	Operation-off	Operation-off	-
X	●	X	X	Error of room temperature sensor in the indoor unit (Open/Short)	<ul style="list-style-type: none"> Check indoor temperature sensor connection. Check indoor temperature sensor's resistance value to see if it's short/open. 	Operation-off	Operation-off	Operation-off	-
●	●	X	X	Error of heat exchanger IN/OUT sensor in the indoor unit (Open/Short)	<ul style="list-style-type: none"> Check EVA IN/OUT sensor connection. Check EVA IN/OUT sensor's resistance value to see if it's short/open. 	Operation-off	Operation-off	Operation-off	-
X	X	●	X	Error of fan motor in the indoor unit	<ul style="list-style-type: none"> Check the connection of motor connector Check the speed of the motor fan 	Operation-off	Operation-off	Operation-off	-
●	X	●	X	Error of the outdoor temperature sensor Error of the condenser temperature sensor Error of the discharge temperature sensor	<ul style="list-style-type: none"> Check indoor temperature sensor connection. Check indoor temperature sensor's resistance value to see if it's short/open. 	Operation-off	Operation-off	Operation-off	-
X	●	●	X	No communication for 2 minutes between indoor and outdoor unit (communication error for more than 2 minutes)	<ul style="list-style-type: none"> Check connection between indoor and outdoor heat exchangers' communication cables 	Operation-off	Operation-off	Operation-off	-
X	●	●	●	Error of outdoor unit	<ul style="list-style-type: none"> Check error occurred with outdoor heat exchanger. TERMINAL Block thermal FUSE error.(OPEN) 	Operation-off	Operation-off	Operation-off	-
X	X	●	●	Detection of the float switch	<ul style="list-style-type: none"> Check float switch connection. Check whether the drain has been filled with water. 	Operation-off	Operation-off	Operation-off	-
●	●	●	●	EEPROM error EEPROM option error	<ul style="list-style-type: none"> Check if there is damage with EEPROM component. Check the indoor model to set the options. Inspection for match between indoor and outdoor machine models 	Operation-off	Operation-off	Operation-off	-
●	X	●	●	Outdoor valve clogging error.	<ul style="list-style-type: none"> High pressure check valve clogging. 	Operation-off	Operation-off	Operation-off	-
●	X	X	●	MDS (Motion Detecting Sensor) Error	<ul style="list-style-type: none"> Check MDS 	-	-	-	-
●	●	X	●	Error due to connecting outdoor units that do not support the Wind-Free function	<ul style="list-style-type: none"> Check outdoor main PBA S/W Check outdoor EEPROM 	-	-	-	-

○: On ●: Blink X: Off

4-2-4 Outdoor Unit

No.	Error Code	Meaning	Remarks
1	E108	Error due to duplicated communication address	Check on repeated indoor unit main address
2	E121	Error on room temperature sensor of indoor unit (Short or Open)	Indoor unit Room Thermistor Open/Short
3	E122	Error on EVA IN sensor of indoor unit (Short or Open)	Indoor unit EVA_IN Thermistor Open/Short
4	E123	Error on EVA OUT sensor of indoor unit (Short or Open)	Indoor unit EVA_OUT Thermistor Open/Short
5	E153	Error on float switch (2nd detection)	Indoor unit Float Switch Open/Short Drain Pump operation Check
6	E154	Indoor fan error	Check on indoor unit indoor Fan operation
7	E164	Error due to connecting outdoor units that do not support the Wind-Free function	Check outdoor main PBA S/W, Check outdoor EEPROM data
8	E201	Communication error between the indoor unit and outdoor unit (Pre-tracking failure or when the actual number of indoor units are different from the indoor unit quantity setting on the outdoor unit) Error due to communication tracking failure after initial power is supplied (The error occurs regardless of the number of units.)	Check indoor quantity setting in outdoor
9	E202	Communication error between indoor unit and outdoor unit (When there is no response from indoor units after tracking is completed)	Check electrical connection and setting between indoor unit and outdoor unit
10	E203	Communication error between the outdoor unit and main micom (For PF #4 to #6 controllers, error will be determined from the time when the compressor is turned on.)	Check electrical connection and setting between outdoor unit MAIN PBA - INVERTER PBA
11	E221	Error on outdoor temperature sensor (Short or Open)	Check Outdoor sensor Open / Short
12	E231	Error on outdoor COND OUT sensor (Short or Open)	Check Cond-Out sensor Open / Short
13	E251	Error on discharge temperature sensor of compressor 1 (Short or Open)	Check Discharge sensor Open / Short
14	E320	Error on OLP sensor (Short or Open)	Check OLP sensor Open / Short
15	E403	Compressor down due to freeze protection control	Check Outdoor Cond.
16	E404	System stop due to overload protection control	Check Comp. when it starts
17	E407	High Pressure Switch Error or High Pressure Switch Connector Open	Check Comp Pressure or Check the Connection of the CN003 on the MAIN-OUT PBA
18	E416	System stop due to discharge temperature	-
19	E422	Blockage detected on high pressure pipe	<ol style="list-style-type: none"> 1. Check if the service valve is open 2. Check for refrigerant leakage (pipe connections, heat exchanger) and charge refrigerant if necessary 3. Check if there's any blockage on the refrigerant cycle (indoor unit/outdoor unit) 4. Check if Additional refrigerant has been added after pipe extension
20	E425	Reverse phase or open phase	Check whether 3 phase is reversed or opened.
21	E440	Heating operation restricted at outdoor temperature over Theat_high value (default:30°C)	<ol style="list-style-type: none"> 1. Check the range of temperature limited for heating operation 2. Check the outdoor temperature sensor

No.	Error Code	Meaning	Remarks
22	E441	Cooling operation restricted at outdoor temperature below Tcool_low value (default:0°C)	1. Check the range of temperature limited for cooling operation 2. Check the outdoor temperature sensor
23	E458	Fan speed error	FAN1 ERROR
24	E461	Error due to operation failure of inverter compressor	-
25	E462	System stop due to full current control	-
26	E463	Over current trip / PFC over current error	Check OLP sensor
27	E464	IPM Over Current(O.C)	1. Check if the service valve is open 2. Check the state of refrigerant 3. Check if connecting wire and the pipe are OK 4. Check the compressor
28	E465	Comp. Over load error	-
29	E466	DC-Link voltage under/over error	Check AC Power and DC Link Voltage
30	E467	Error due to abnormal rotation of the compressor or unconnected wire of compressor	Check Comp wire
31	E468	Error on current sensor (Short or Open)	Check Outdoor Inverter PBA
32	E469	Error on DC-Link voltage sensor (Short or Open)	-
33	E470	Outdoor unit EEPROM Read/Write error (Option)	Check Outdoor EEPROM Data
34	E471	Outdoor unit EEPROM Read/Write error (H/W)	Check Outdoor EEPROM PBA
35	E474	Error on IPM Heat Sink sensor of inverter 1 (Short or Open)	Check Outdoor Inverter PBA
36	E475	Error on inverter fan 2	FAN2 ERROR
37	E483	Overvoltage of H/W detect DC link	Check AC Power
38	E484	PFC Overload (Over current) Error	Check Outdoor Inverter PBA
39	E485	Error on input current sensor of inverter 1 (Short or Open)	Check Outdoor EEPROM PBA
40	E488	Inverter input voltage sensor error	Check Outdoor Inverter PBA
41	E500	IPM over heat error on inverter 1	Check Outdoor Inverter PBA
42	E508	Smart install is not installed	-
43	E554	Gas leak detected	Check the refrigerant
44	E556	Error due to mismatching capacity of indoor and outdoor unit	Check the indoor and outdoor unit capacity
45	E557	DPM remote controller option error	Check the indoor option code
46	E590	Inverter EEPROM Checksum error	-

4-2-5 Wired remote controller

- If an error occurs, () icon will be displayed on the wired remote controller.
- Press the Test button to see the error code.

Error mode	Contents	Measure	Product operation in error condition	Error type
			Outdoor unit/ Compressor/Indoor unit	
101	Indoor unit communication error	Check the communication cable of indoor unit. Check the DC output voltage at the communication terminal.	Operation Off	Communication error
108	Duplicated address setting error	Check address setting of Indoor units.	Operation Off	Communication error
109	No response error address from indoor unit	Check indoor unit's quantity setting in outdoor unit. Check electrical connection and setting.	Operation Off	Communication error
121	Indoor temperature sensor (open/short error)	Check indoor unit room temperature sensor. Check indoor unit PCB connector CN41. (White)	Operation Off	Indoor sensor error
122	Indoor unit Eva In sensor (Open/Short)	Check indoor unit pipe sensor. Check indoor PCB connector CN41.(White)	Operation Off	Indoor sensor error
153	Indoor floating switch secondary detection	Check indoor unit float sensor. Check indoor PCB connector CN5. (Black)	Operation Off	Self diagnostic error
202	Indoor/outdoor communication error (1 min)	Check the communication connection between indoor and outdoor units. Check the power line and communication cable connection status	Operation Off	Communication error
203	Communication error between indoor/outdoor INV ↔ MAIN MICOM (1 min)	Check MAIN MICOM. Check INVERTER MICOM.	-	Communication error
221	Outdoor temperature sensor error	Check sensor connection status. Check sensor location. Check sensor resistance.	Operation Off	Outdoor sensor error
231	COND temperature sensor error	Check sensor connection status. Check sensor location. Check sensor resistance.	Operation Off	Outdoor sensor error
251	[Inverter] Emission temperature sensor error	Check sensor connection status. Check sensor location. Check sensor resistance.	Operation Off	Outdoor sensor error
403	Detection of Indoor Freezing (when Comp. Stops)	Check whether the indoor unit air intake is blocked. Check the operation of the indoor fan.	Operation Off	Outdoor unit protection control error
404	Protection of Outdoor Overload (when Comp. Stops)	Check sensor connection status. Check sensor location. Check sensor resistance.	Operation Off	Outdoor unit protection control error
407	High Pressure Switch Error or High Pressure Switch Connector Open	Check Comp Pressure Check the Connection of the CN003 on the MAIN-OUT PBA	Outdoor Operation Off	Outdoor Unit Protection Control Error
416	Emission temperature excessively high	No error. (DISCHARGE temperature control)	-	Outdoor unit protection control error
422	High pressure blockage error (Refrigerant completely Leakage error)	Check whether the outdoor unit service valve is open. Check the connection of the pipes. Check the operation of the EEV. Check for refrigerant leakage. (Completely leakage).	Operation Off	Self diagnostic error

Wired remote controller (cont.)

Error mode	Contents	Measure	Product operation in error condition	Errortype
			Outdoor unit/Compressor/Indoor unit	
440	Heating operation blocked	Check the operation setting state. Check temperature sensor.	Operation Off	Self diagnostic error
441	Cooling operation blocked	Check the operation setting state. Check temperature sensor.	Operation Off	Self diagnostic error
458	Outdoor fan1 error	Check input power connection status. Check the connection status between the motor and outdoor unit PCB. Check indoor/outdoor fuse.	Operation Off	Self diagnostic error
461	[Inverter] Compressor startup error	Check the compressor connection status. Check the resistance between difference phases of the compressor.	Operation Off	Outdoor unit protection control error
462	[Inverter] Total current error/ PFC over current error	Check the input power Check the refrigerant charging status Check the normal operation of outdoor fan	Operation Off	Outdoor unit protection control error
463	OLP Overheat and Comp. Stop	Reconfirm the opening of the service valve. Check for leaks from the connection part of the pipe and product or from the pipe joint. Change the outdoor unit location and direction. Refill the refrigerant after checking the leaking part. Reinstall the outdoor unit set.	Operation Off	Outdoor unit protection control error
464	[Inverter] IPM over current error	Check refrigerant charging Check the compressor connection status and normal operation Check the obstacles around the indoor and outdoor units Check whether the outdoor unit service valve is open Check whether the indoor/outdoor installation pipe/wiring are correct	Operation Off	Outdoor unit protection control error
465	Compressor / limit error	Check the compressor connection status Check the resistance between difference phases of the compressor	Operation Off	Outdoor unit protection control error
466	DC LINK over/low voltage error	Check input power Check AC power connection	Restart in 3 minutes	Outdoor unit protection control error
467	[Inverter] Compressor rotation error	Check the compressor connection status Check the resistance between difference phases of the compressor	Operation Off	Outdoor unit protection control error
468	[Inverter] Current sensor error	Check EEPROM DATA Check the normal operation of PCB	Operation Off	Outdoor unit protection control error
469	[Inverter] DC LINK voltage sensor error	Check the input power connection Check the status of RY21 and R200 in the INVERTER PCB	Operation Off	Outdoor unit protection control error
470	EEPROM Read/Write error	-	Operation Off	Outdoor unit protection control error

Wired remote controller (cont.)

Error mode	Contents	Measure	Product operation in error condition	Errortype
			Outdoor unit/Compressor/Indoor unit	
401	[Inverter] OTP error	Check EEPROM DATA Check the normal operation of PCB	Operation Off	Outdoor unit protection control error
402	AC ZERO CROSSING SIGNAL OUT error	Check the input power status	Operation Off	Outdoor unit protection control error
403	Compressor LOCK error	Check the compressor connection status Check the resistance between difference phases of the compressor	Operation Off	Outdoor unit protection control error
405	Outdoor fan 2 error	Check the input power connection status Check the connection status of the motor and the outdoor unit PCB Check the indoor/outdoor unit fuse	Operation Off	Self diagnostic error
500	IPM Overheat Error for Outdoor Unit Inverter Comp.	Change the location of the outdoor unit if the temperature is abnormally high when the heatproof plate is checked. Reconnect the screws. Replace the outdoor unit fan. Replace the PBA of the outdoor unit.	Operation Off	Outdoor unit protection control error
554	Gas leak error	Check the refrigerant charging status Check the indoor EVA sensor Check if the outdoor unit service value is open Check that the indoor/outdoor installation pipe/wiring are correct	Operation Off	Self diagnostic error
556	Capacities not matched	Check the option code of the indoor unit	Operation Off	Outdoor unit protection control error
601	Communication error between the indoor unit and wired remote controller	Check the connection wire between the indoor unit and the wired remote controller	Normal operation	Wired remote controller error
602	Communication error between the Master and Slave wired remote controllers	Check the option switch for defining the Master and Slave (only one Master and one Slave can exist)	Normal operation	Wired remote controller error
606	COM1/COM2 cross installation error	Check that wired remote controller is connected to the COM2 terminal of the indoor unit	Normal operation	Wired remote controller error
8EA	Wired remote controller COM2 option setting error	Check that Com1, Com2 setting DIP switch is set to Com2	Normal operation	Wired remote controller error

4-3 Troubleshooting by symptoms

4-3-1 Indoor temperature sensor (open/short)

Indoor unit display	X (Operation) ● (Defrost) X (Timer) X (Filter)
Symptom	In case of open or short circuit of indoor temperature sensor
Failure	Short or leakage of the corresponding sensor

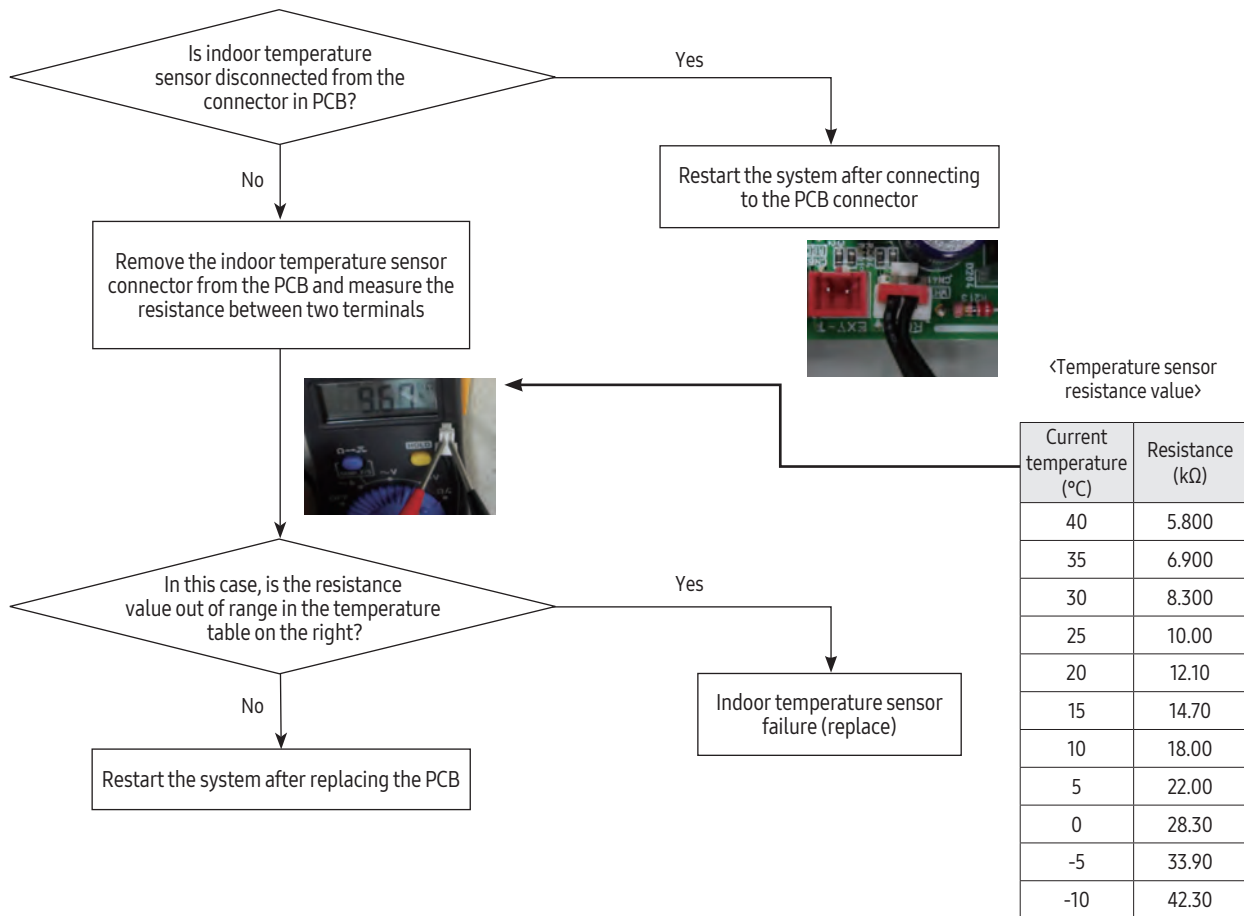

4-3-2 Indoor heat exchanger temperature sensor (open/short)

Indoor unit display	● (Operation) ● (Defrost) X (Timer) X (Filter)
Symptom	Short or open circuit of indoor heat exchanger temperature sensor
Failure	Short or open circuit in the corresponding sensor

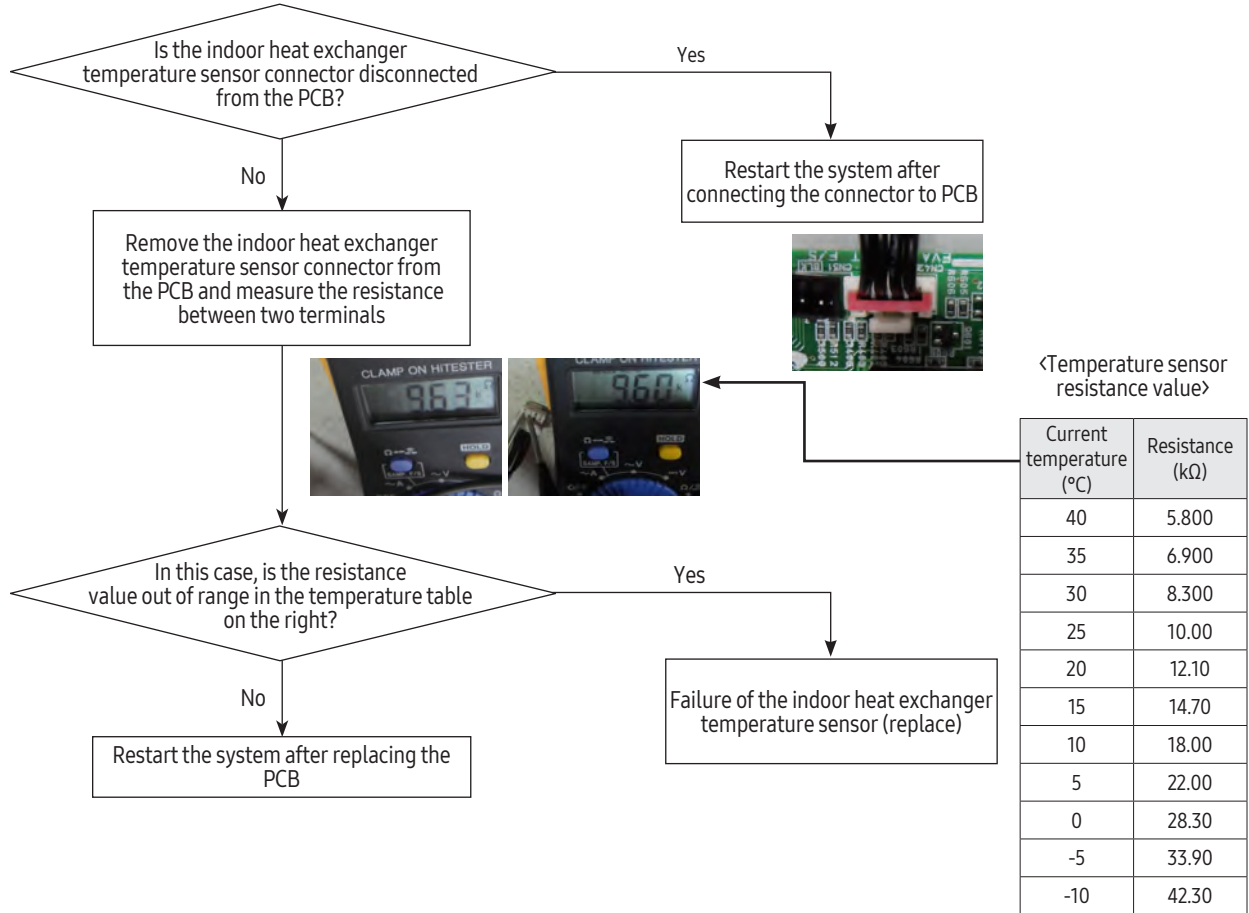

4-3-3 Indoor FAN error

Indoor unit display	X (Operation) X (Defrost) ● (Timer) X (Filter)
Symptom	Indoor unit fan does not run /Runs at excessive high speed and stops.
Failure	. Motor connector break away . Indoor unit FAN does not run : Defective motor or PBA

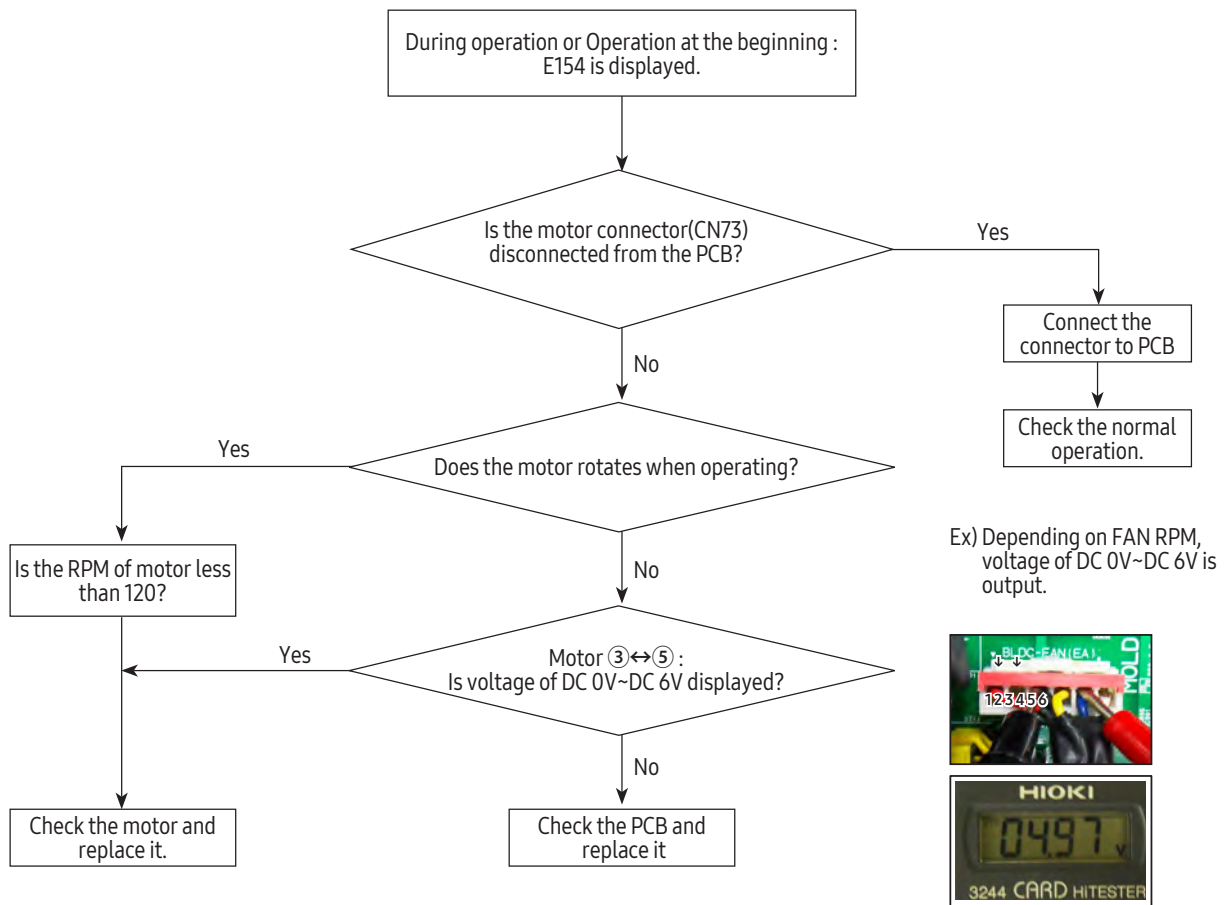

4-3-4 Communication error after finishing Tracking

Indoor unit display	X (Operation) ● (Defrost) ● (Timer) X (Filter)
Symptom	Communication error between the indoor and outdoor unit for two minutes
Failure	Communication error between the indoor unit and outdoor unit

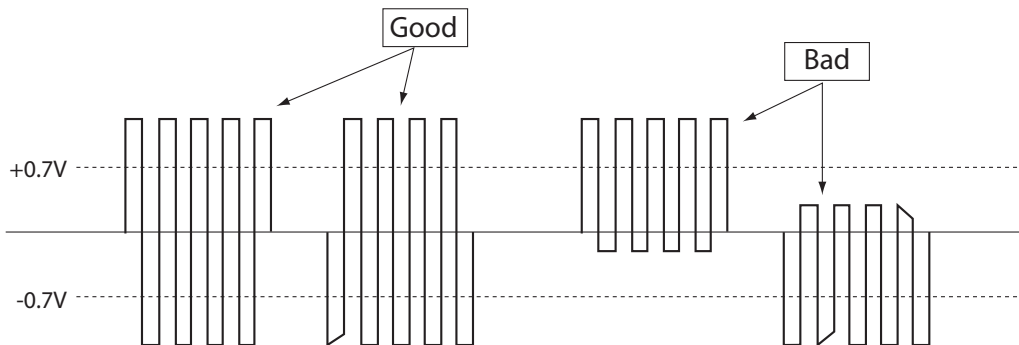
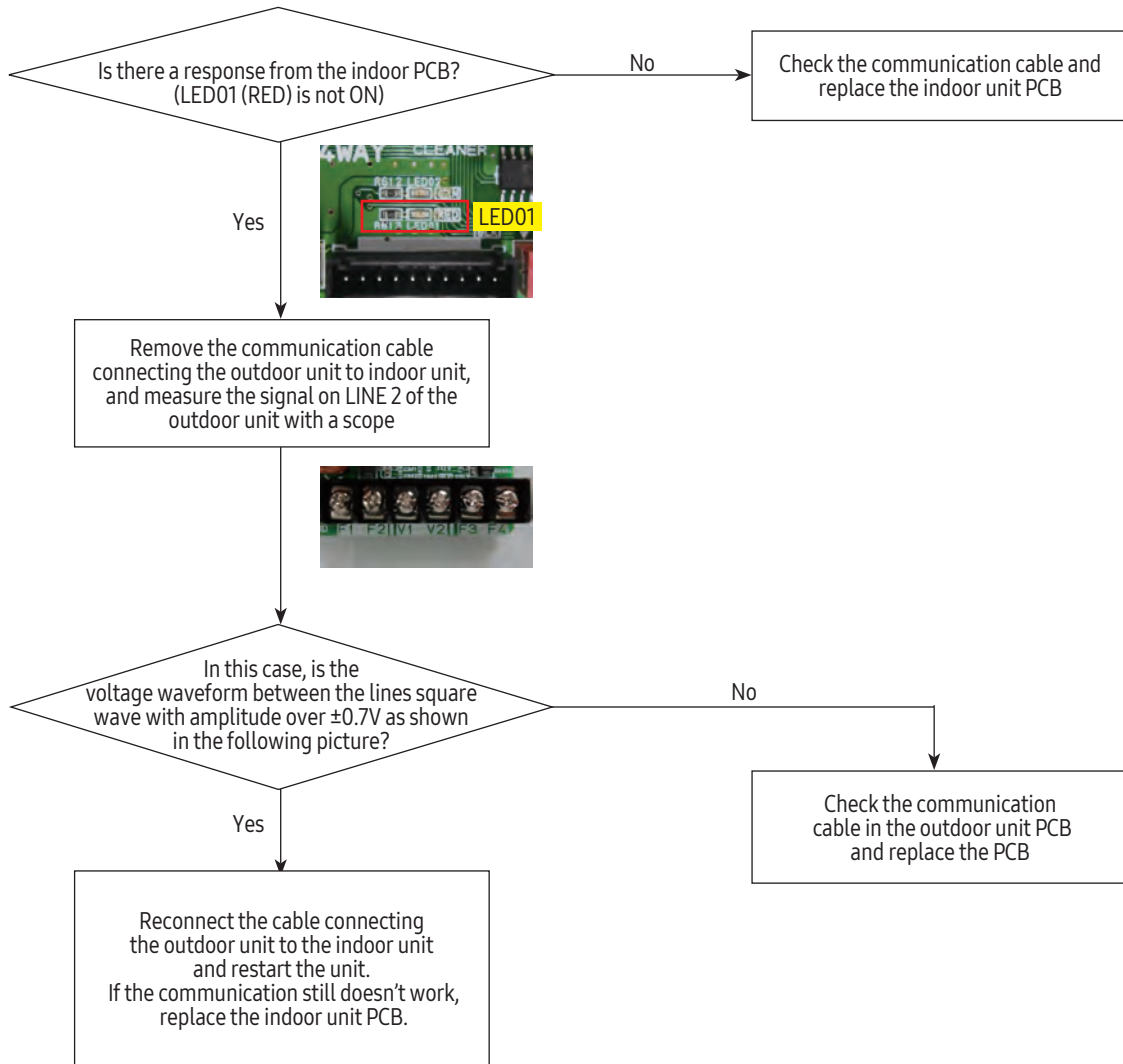

4-3-5 Indoor unit float sensor error

Indoor unit display	X (Operation) X (Defrost) ● (Timer) ● (Filter)
Symptom	The indoor unit floating sensor is open and that state is maintained for more than one minute
Failure	Increase in the drain pan water level due to failure of the indoor unit drain pump, or float sensor failure

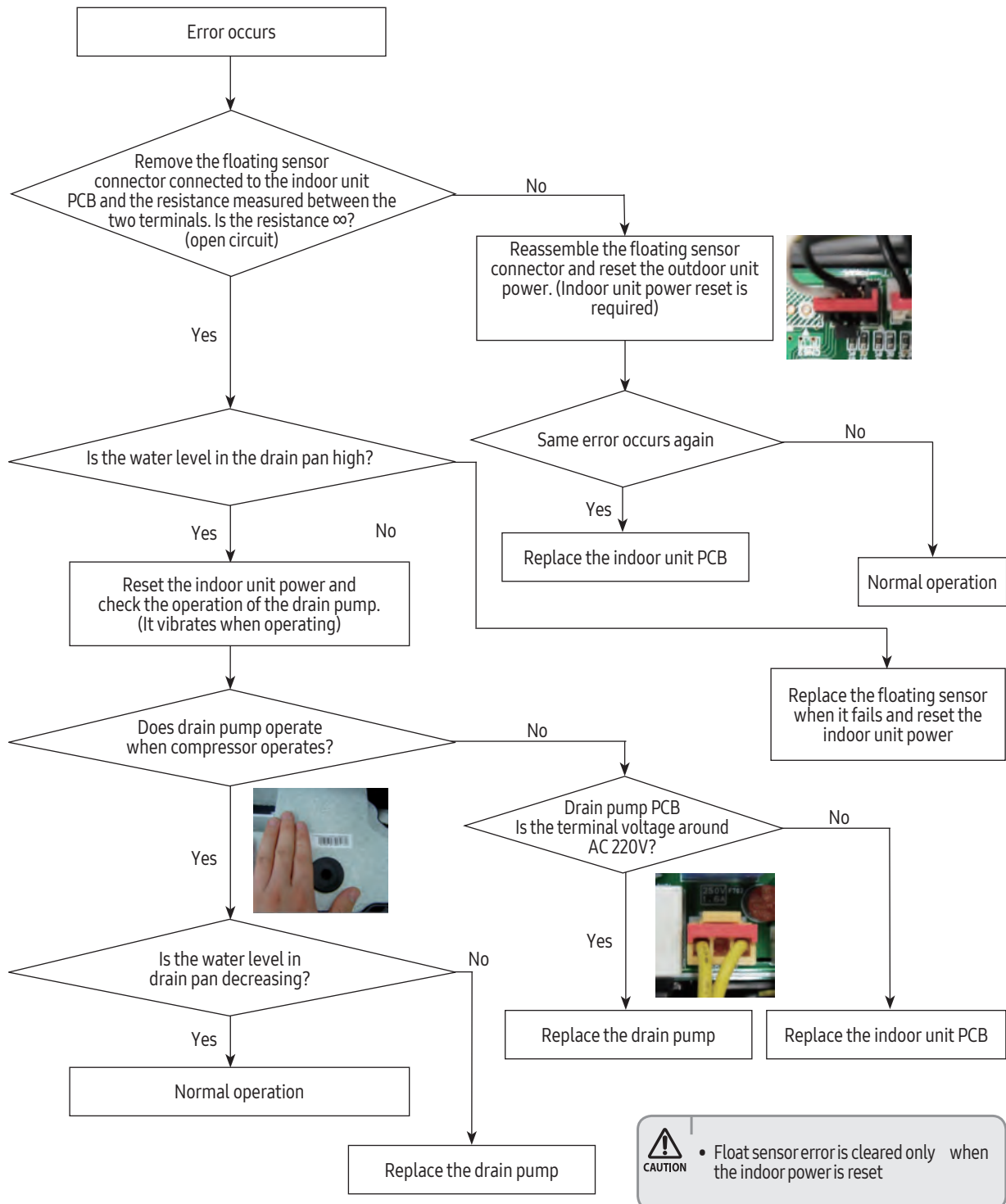

4-3-6 EEPROM circuit failure

Indoor unit display	● (Operation) ● (Defrost) ● (Timer) X (Filter)
Symptom	EEPROM circuit failure
Failure	EEPROM component failure, EEPROM circuit parts missing/damaged/soldering failure

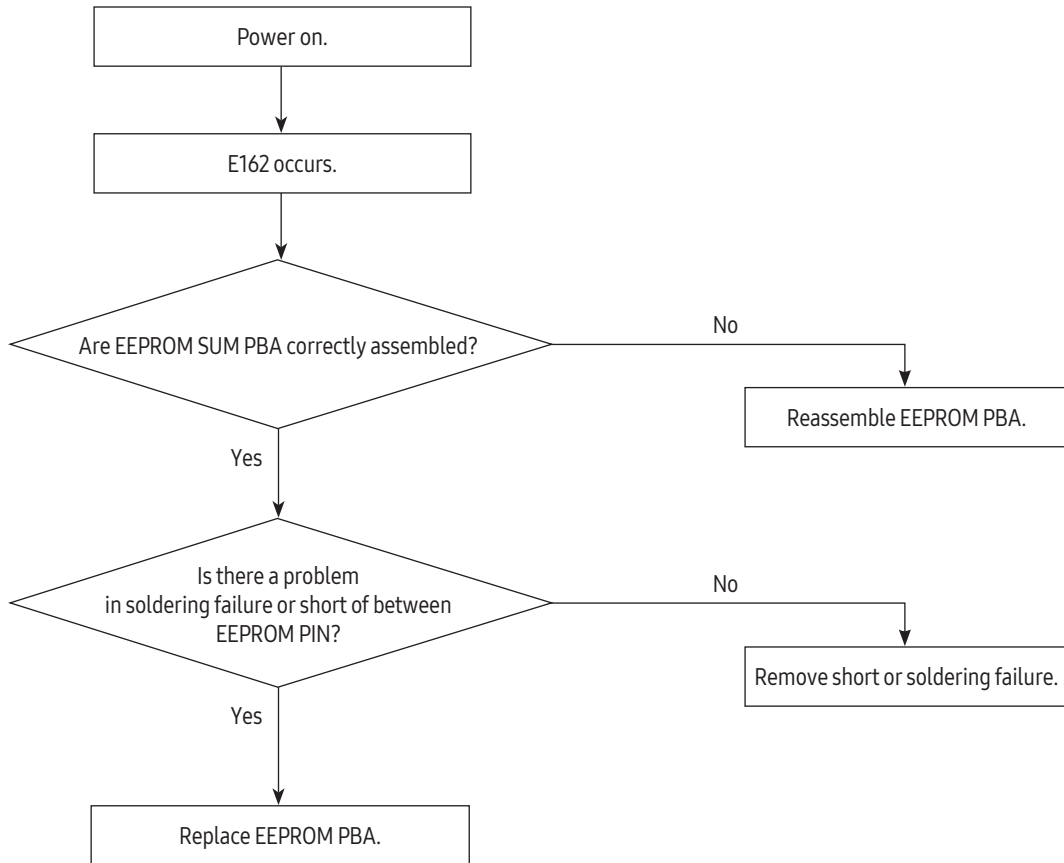

4-3-7 E407

Indoor unit display	
Symptom	High Pressure Switch Error or High Pressure Switch Connector Open
Failure	Check Comp Pressure Check the Connection of the CN003 on the MAIN-OUT PBA

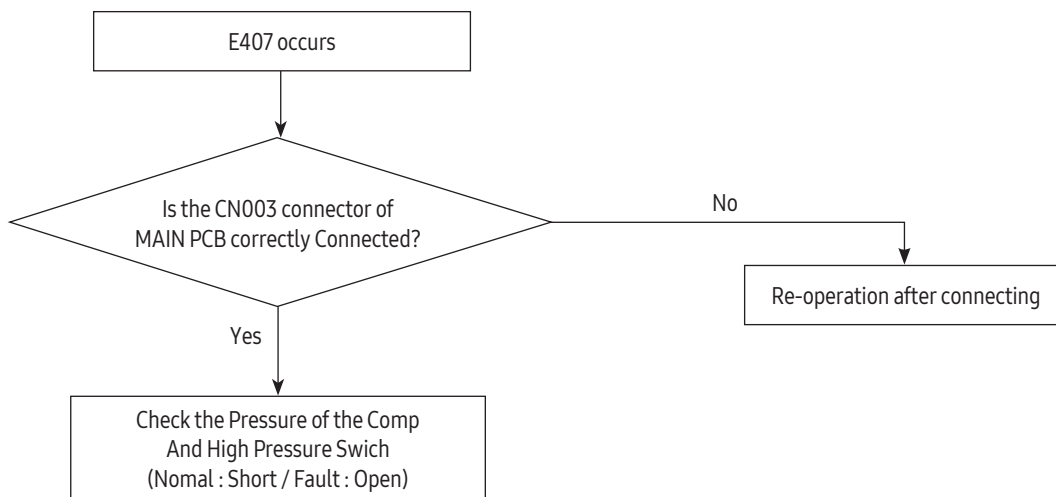

4-3-8 When the outdoor unit power is not ON - Initial Diagnosis : 3-phase products

1. Test items

- 1) Check the power connection of outdoor unit.
 - 2) Check the whole connection part of the power wire.
 - 3) Check the power on the indoor unit.
 - 4) Check the connection of the power wire of the Terminal Block.
 - 5) Check the connection of the power wire between the Main↔EMI PBA of the outdoor unit.
 - 6) Connect the power wire. (Never forget to turn off the power of the Terminal Box).
 - 7) Check the power supply parts. (Check after turning off the power of the Terminal Box!)
 - 8) Check everything is normal after separating the fan motor connector and resetting the power.
(Separate the connector after turning off the power of the Terminal Box! When detaching and attaching the connector during power supply, the motor can be damaged.)
- 7-segment off.
 - Conduct the following test if the mode is not Eco-mode (power saving mode).

2. Check procedure

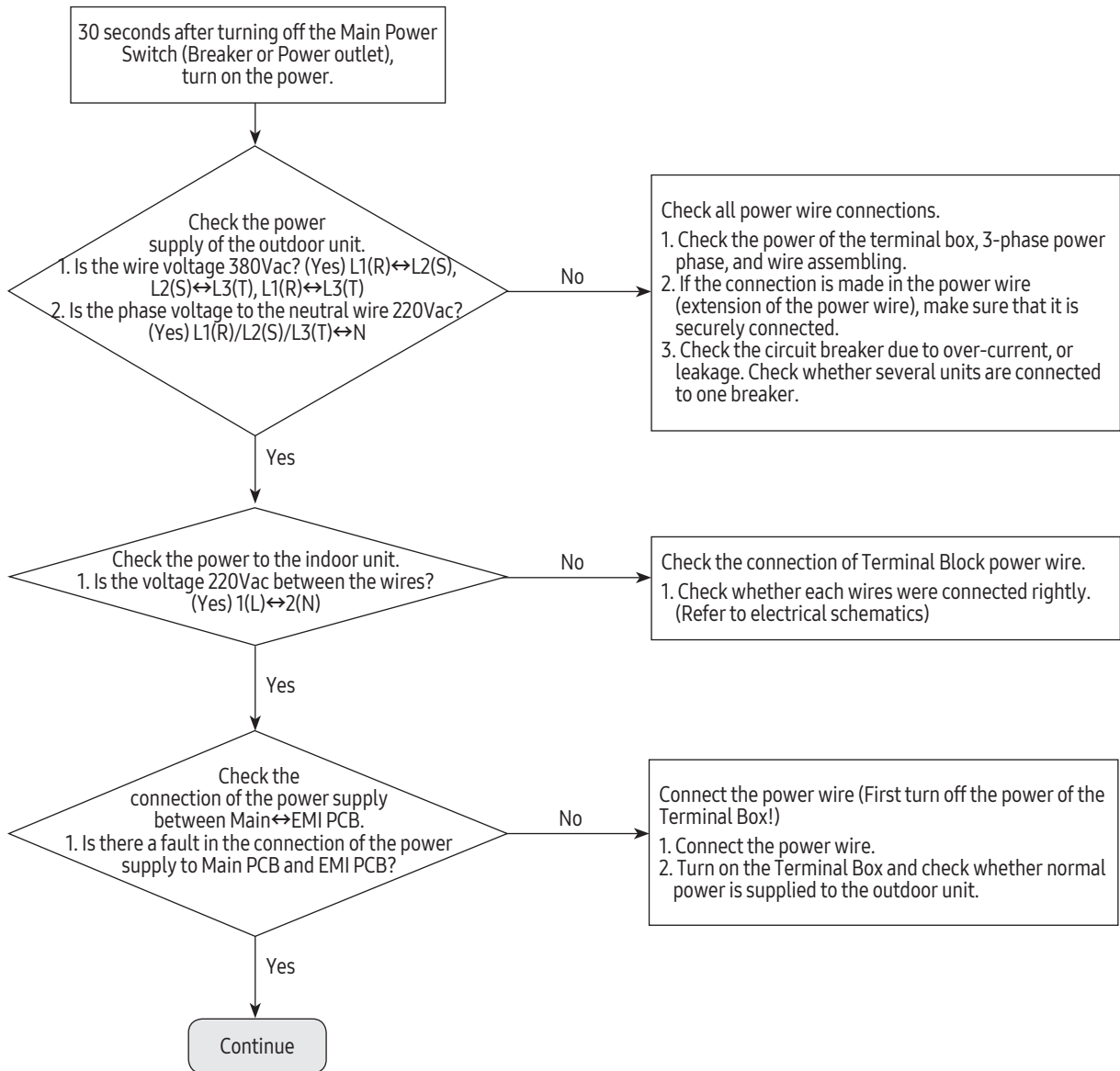

When the outdoor unit power is not ON - Initial Diagnosis : 3-phase products (cont.)

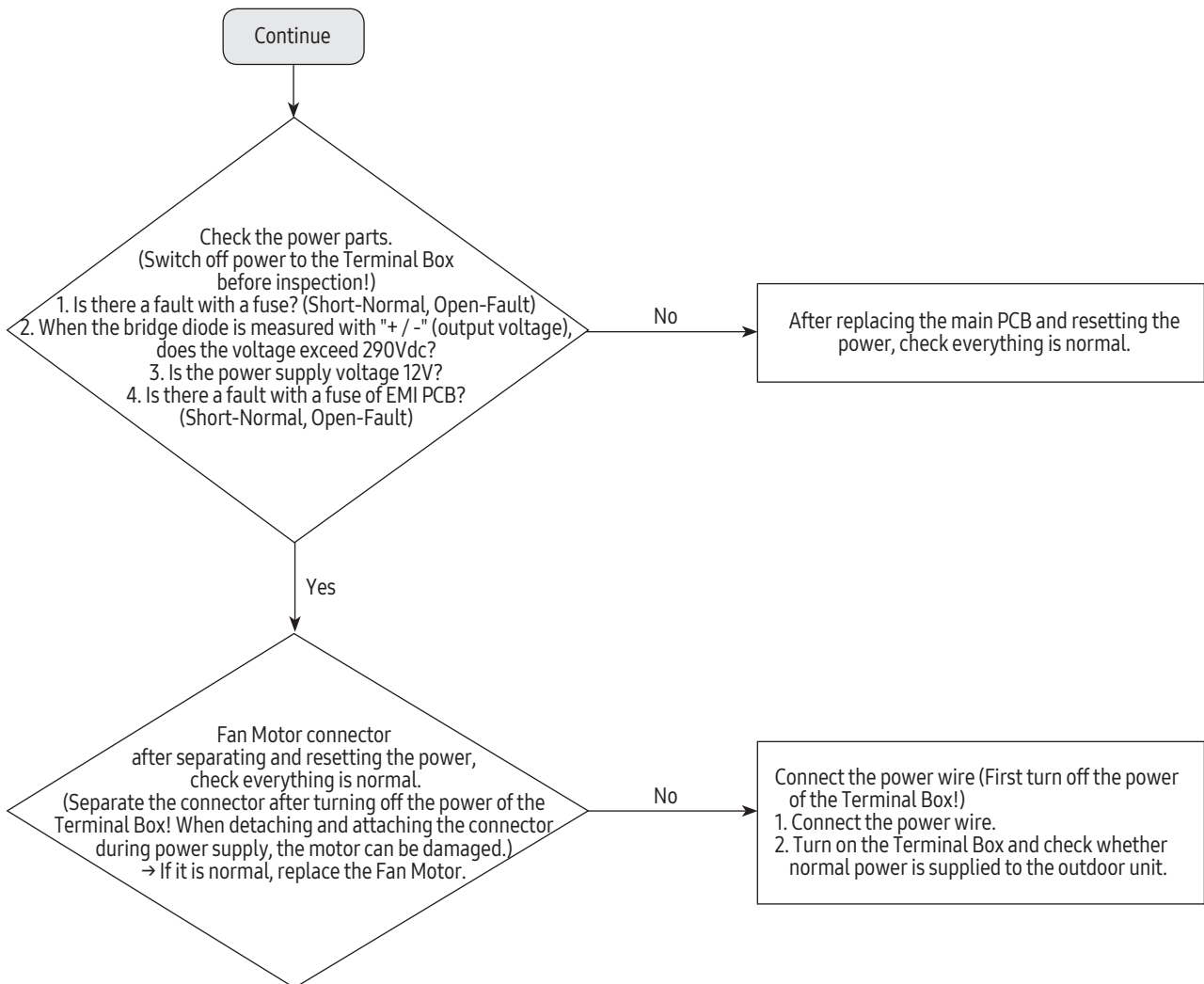

When the outdoor unit power is not ON - Initial Diagnosis : 1-phase products

1. Test items

- 1) Check the power connection of outdoor unit.
 - 2) Check the whole connection part of the power wire.
 - 3) Check the power on the indoor unit.
 - 4) Check the connection of the power wire of the Terminal Block.
 - 5) Check the connection of the power wire between the Main↔EMI PBA of the outdoor unit.
 - 6) Connect the power wire. (Never forget to turn off the power of the Terminal Box).
 - 7) Check the power supply parts. (Check after turning off the power of the Terminal Box!)
 - 8) Check everything is normal after separating the fan motor connector and resetting the power.
(Separate the connector after turning off the power of the Terminal Box! When detaching and attaching the connector during power supply, the motor can be damaged.)
- 7-segment off.
 - Conduct the following test if the mode is not Eco-mode (power saving mode).

2. Check procedure

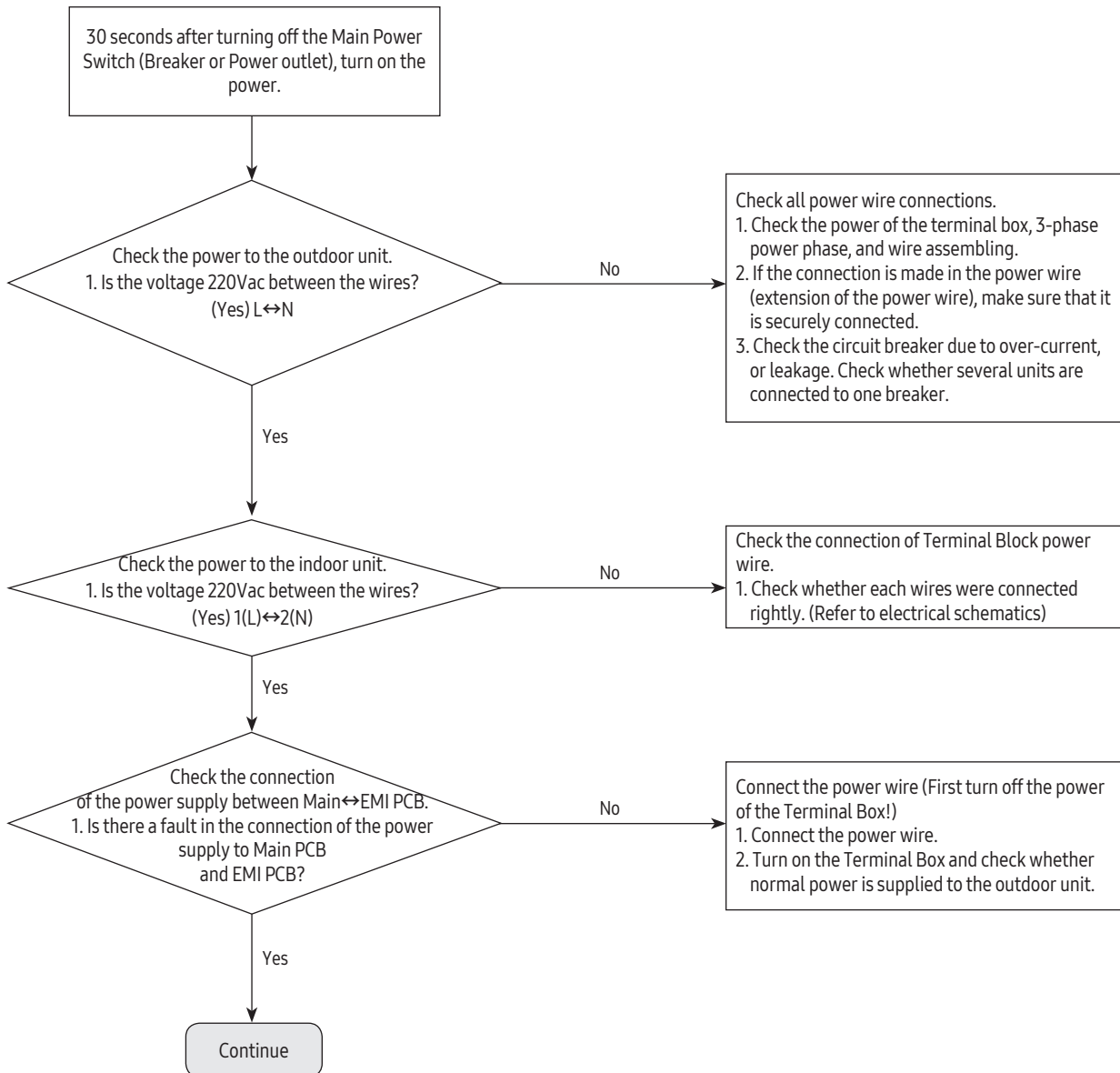

When the outdoor unit power is not ON - Initial Diagnosis : 1-phase products (cont.)

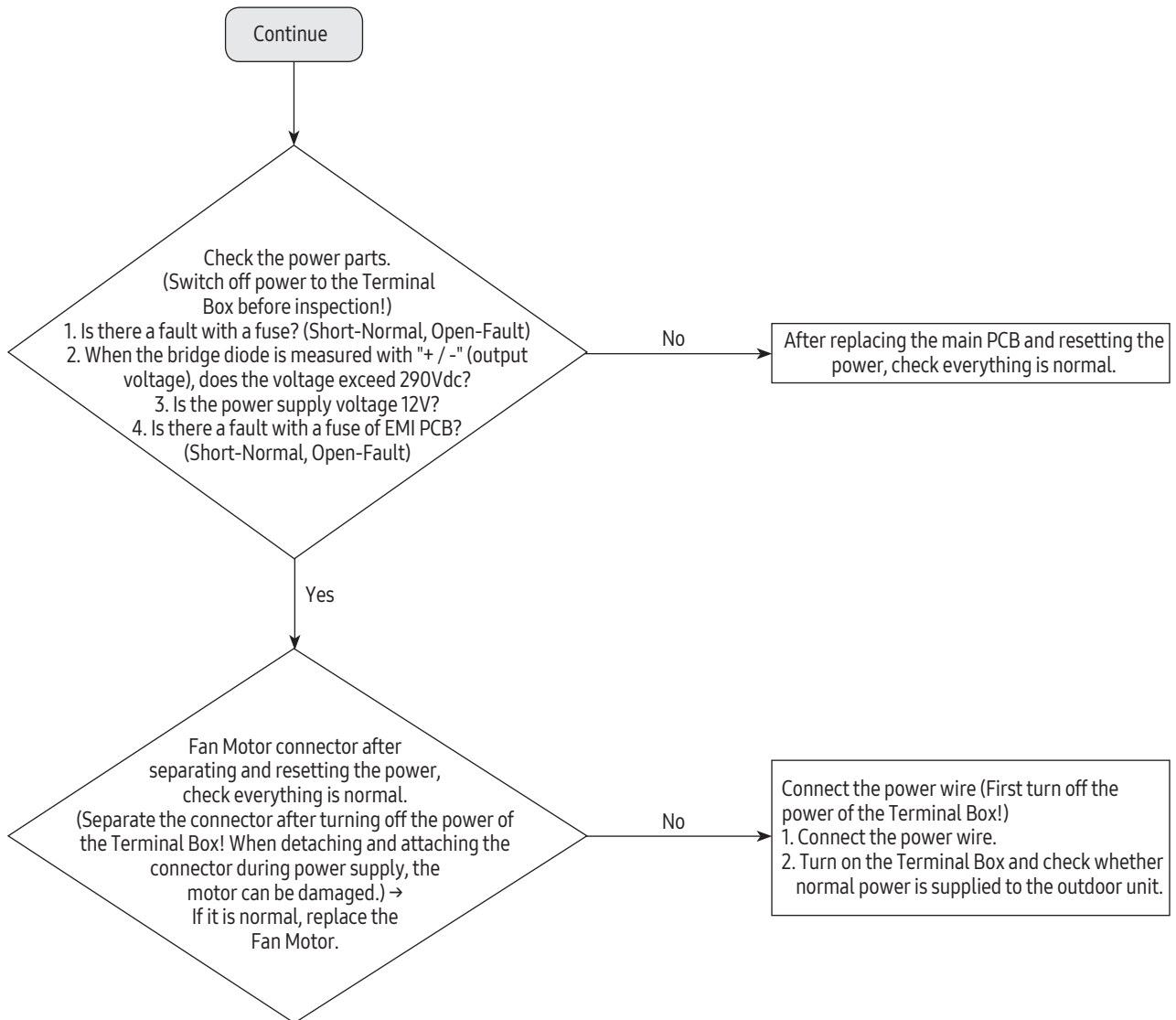

4-3-9 Indoor/outdoor communication error (1min.) (Error Code : E202)

1. Test items
 - 1) Check the communication wire and power wire connection.
 - 2) Check the communication connector connection.
 - CN31 of outdoor unit Main PCB.
 - 3) Check the communication circuit on the PCB.

2. Check procedure

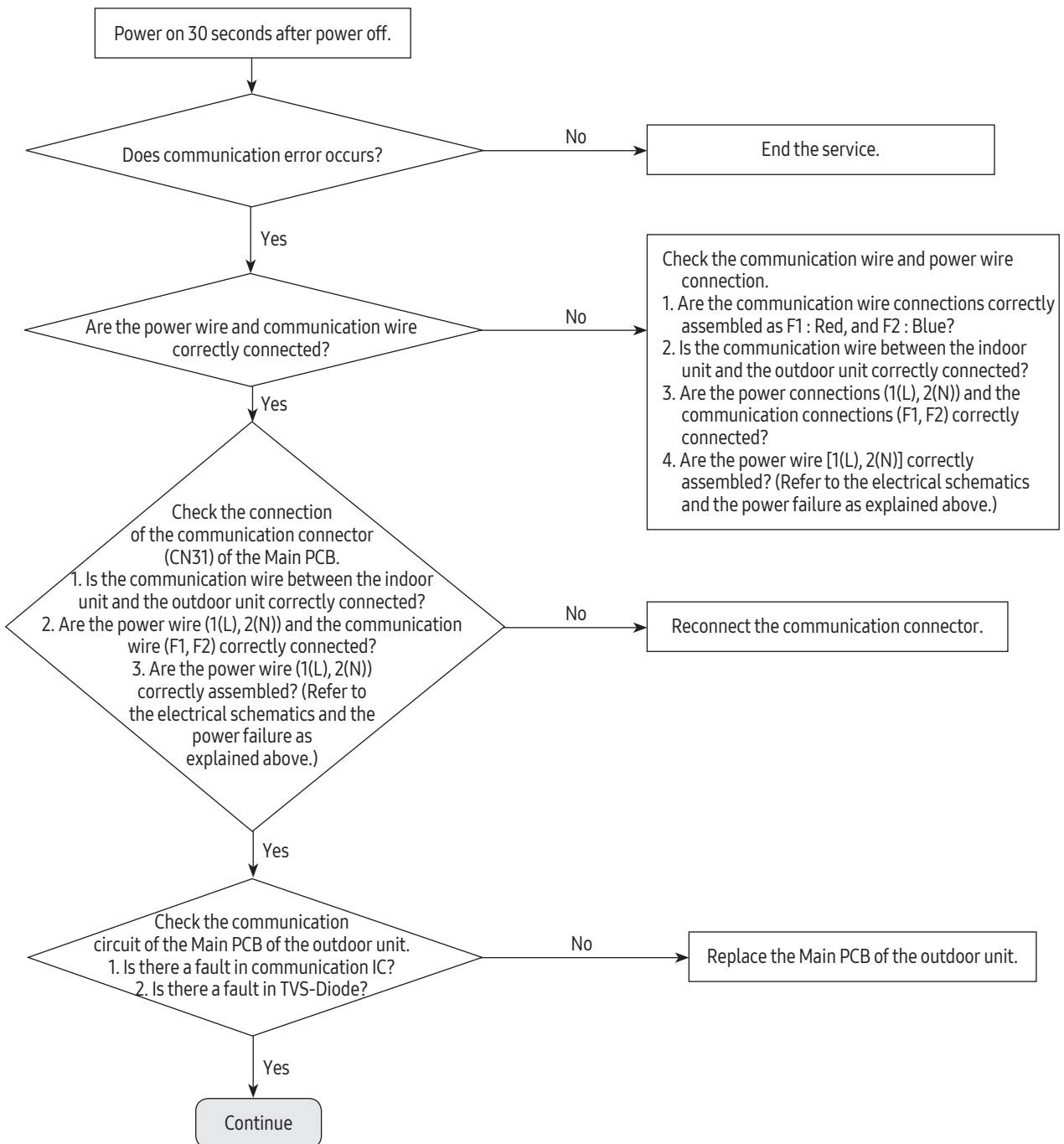

Indoor/outdoor communication error (1 min.) (Error Code: E202) (cont.)

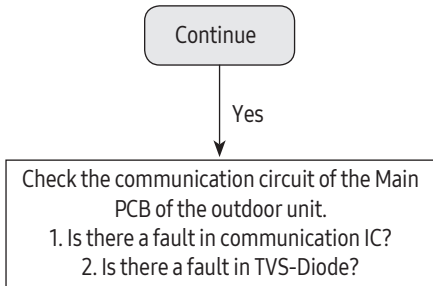

Measuring Part	Communication IC Measuring Part (Circuit Diagram)	Example of Measuring Communication IC	Example of Measuring TVS-Diode
Location			
Measuring Point	#5-GND, #6- Communication A, #7- Communication B, #8-Vcc		

Communication IC Measuring (Port)	Steady-state Measuring Value		Remark
	COM 1(RED)		
#6 - #5	0.9kΩ ~ 1.2kΩ		Measuring after separating the communication connection
#7 - #5	0.9kΩ ~ 1.2kΩ		
#8 - #5	4.7Vdc ~ 5.3Vdc		

TVS-Diode Measuring	Steady-state Measuring Value
Both ends of diode	1kΩ or above

4-3-10 Communication error between outdoor unit INV ↔ MAIN MICOM (1 min.)(Error Code: E203)

1. Test items

- 1) Is power supplied to outdoor unit Inverter PCB?
- 2) Check the power wire connection and fuse.
- 3) Is there a problem in the communication wire connections between the outdoor unit Inverter (CN31) ↔ Main PCB (CN39)?
- 4) Check the communication wire connections.

2. Check procedure

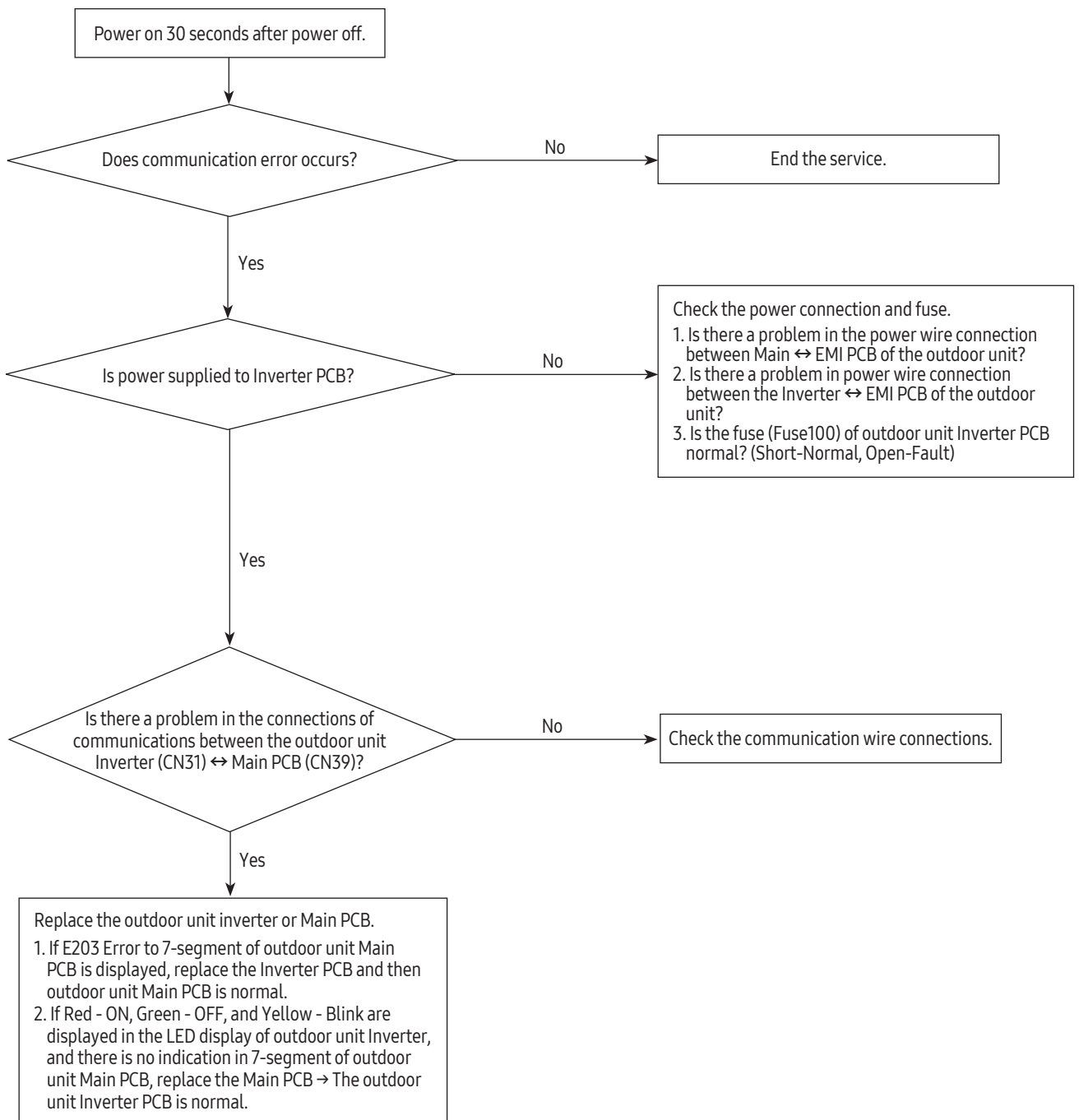

4-3-11 Outdoor sensor error (Error Code : E221, E231, E251, E320)

1. Test items
 - 1) Check the connection of the temperature sensor connector.
 - 2) Check the resistance value of the temperature sensor.
2. Check procedure

Error CODE	Description
E221	Outdoor temperature sensor error
E231	Outdoor temperature sensor error
E251	Outdoor temperature sensor error
E320	Outdoor OLP sensor error

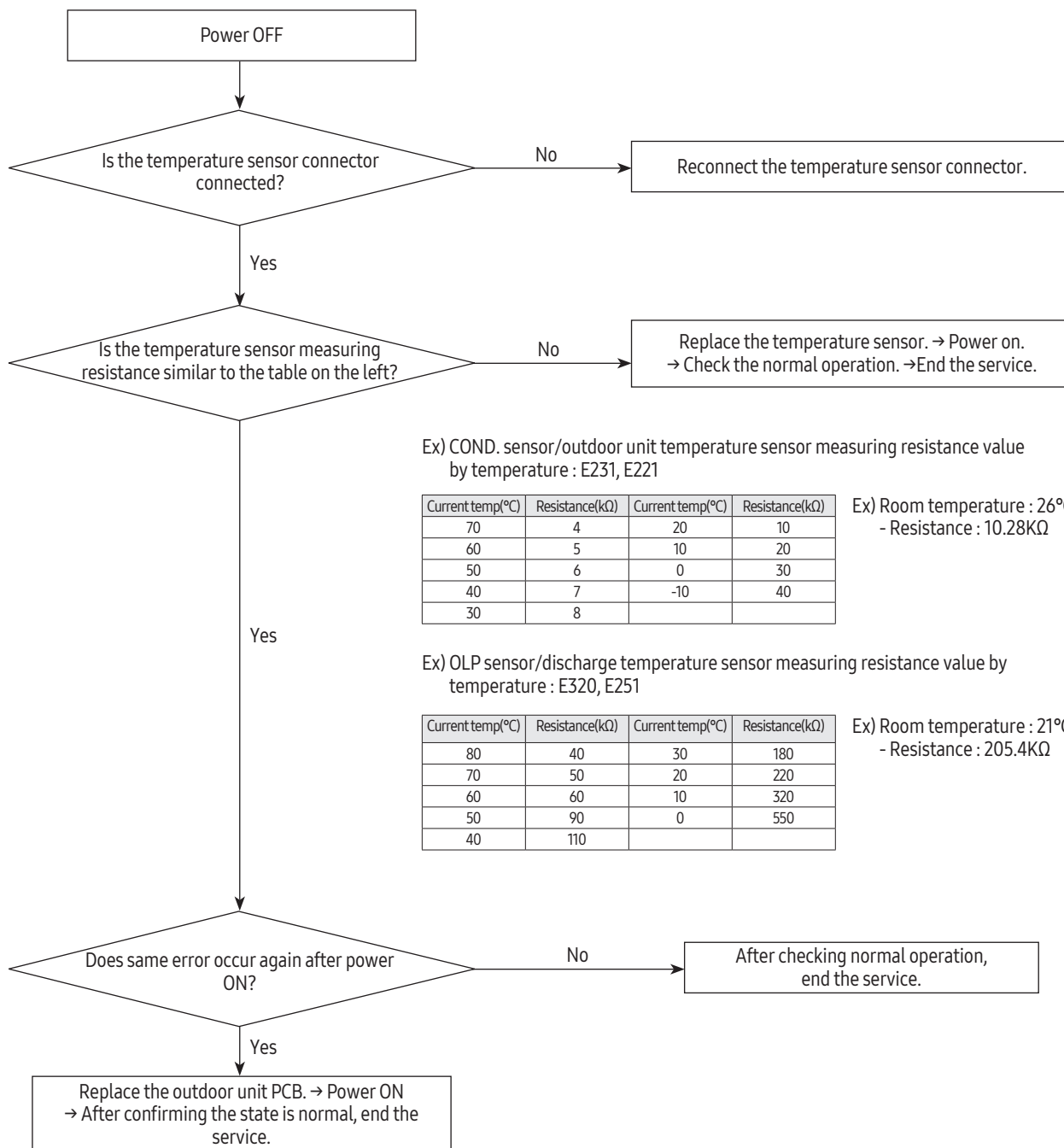

4-3-12 Reverse phase / Loss phase detection (3-phase outdoor unit) (Error Code : E425)

1. When power is on, it checks the power status used for 3-phase power compressor.
When the order of 3-phase L1(R) – L2(S) – L3(T) is changed (Reverse phase) or there is a phase that does not supply power (Loss phase), it will display **E425** and the air conditioner will stop operating. **E425**
 - 1) Check the voltage on L1(R) – L2(S) phase/ L1(R) – L3(T) phase/ L2(S) – L3(T) phase.
 - 2) When there is any terminal that does not have normal voltage, check the external power of the air conditioner and take appropriate measures.
 - 3) If 3-phase power is normal check the phase of the power wire using 3-phase tester. If it shows reverse phase, change the current power wire connection.
 - 4) After completing above, press reset key (K3) then check the power again.

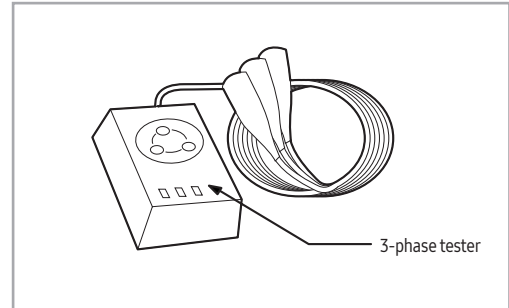

4-3-13 Compressor down due to freezing control (Error Code : E403)

1. Test items

- 1) Check the normal operation of indoor Fan/Motor.
- 2) Check the normal operation of indoor EEV.
- 3) Check the IN/OUT sensor of indoor heat exchanger.
- 3) Check the clogging of indoor air inlet part.

2. Check procedure

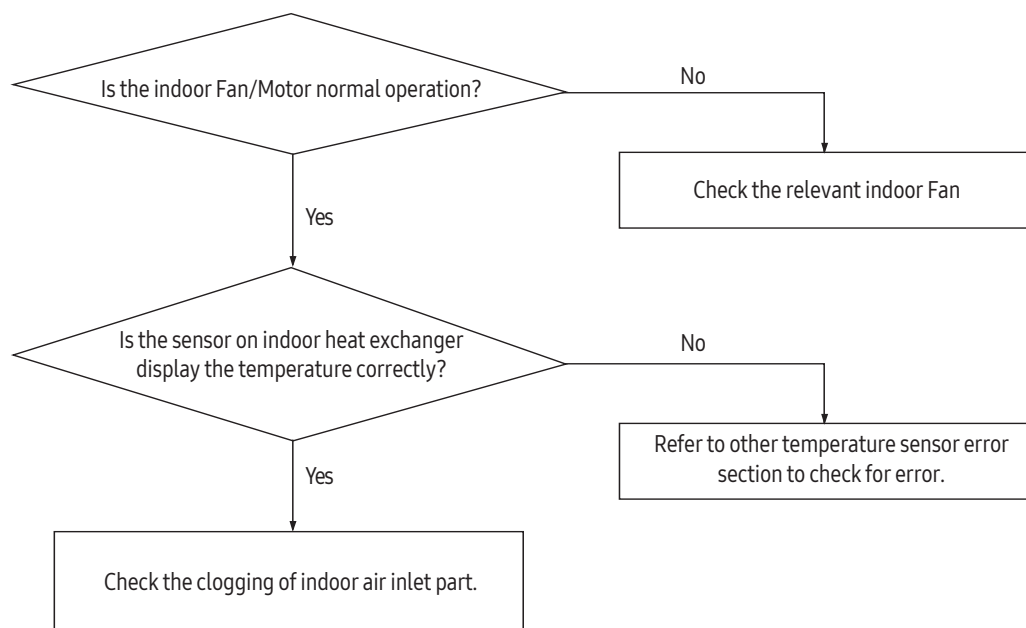

4-3-14 Outdoor unit Fan error (Error Code : E458, E475)

1. Test items

- 1) Check the connection of Fan connectors (CN90, CN91)
- 2) Check the voltage of the fan motor connector in the inverter PBA of the outdoor unit.
- 3) Check the power connection of the outdoor unit Inverter PCB.
- 4) Check the Fan Motor single parts. (Be sure to turn off the power and separate the motor connector after 30 seconds!)

2. Check procedure

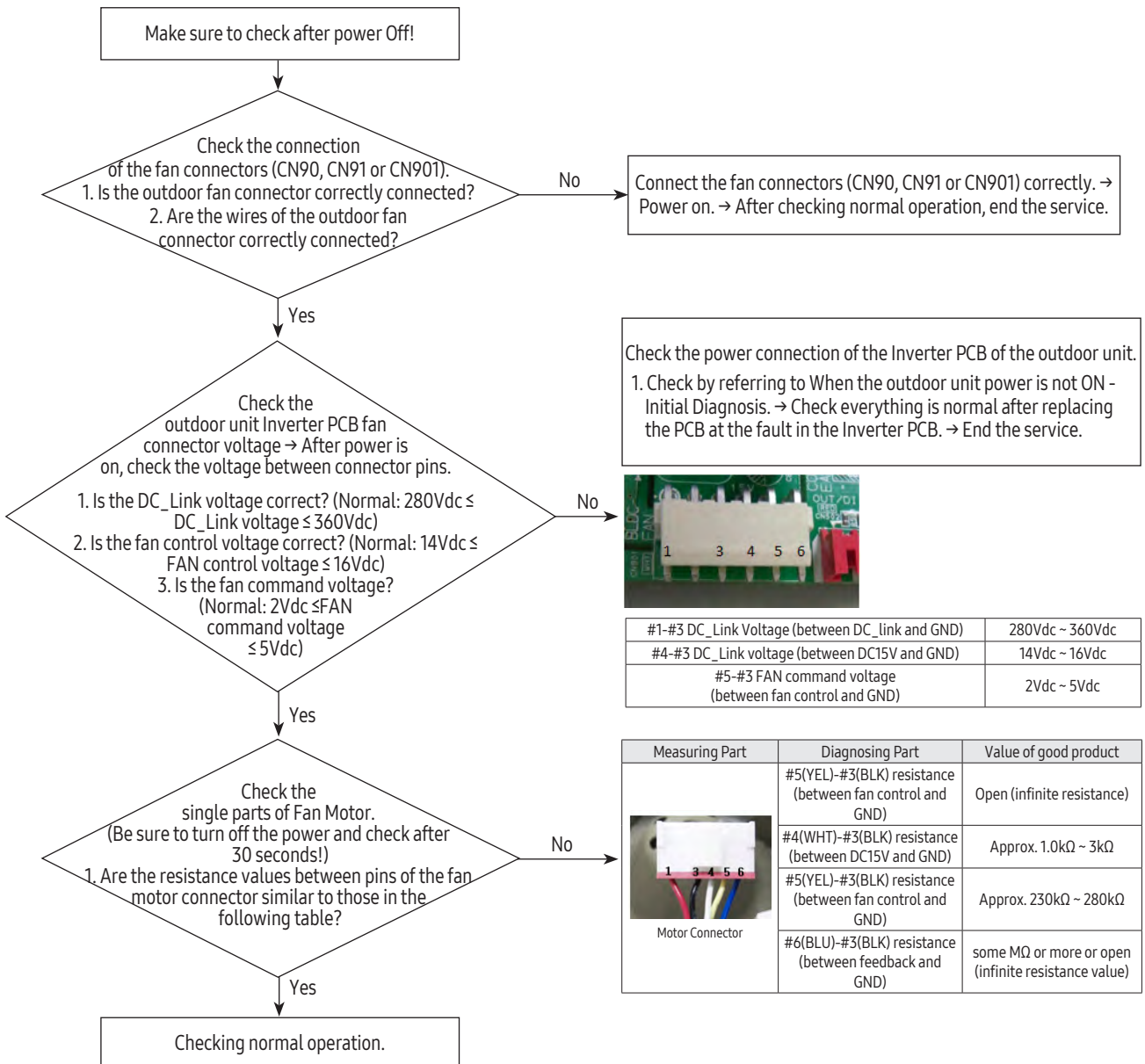

- ※ At least 30 seconds after power is OFF, attach/detach the fan motor connector! → Threatened to cause secondary damage to the motor and the PCB.
- ※ Check the Inverter PCB or Fan Motor single parts and only if there is a fault, replace!
- ※ Do not replace the Main PCB of the outdoor unit relating to the fault in the Fan Motor!
→ If the error is indicated on 7-segment of the Main PCB of the outdoor unit, the Main PCB of the outdoor unit has no fault.
→ In case of a control problem, it is possible to solve with S/W update.

4-3-15 Compressor starting error / rotation error (Error Code : E461, E467)

1. Test items
 - 1) Check the power connection. / Check the restart after power reset.
 - 2) Check the compressor and the state of the compressor wire assembling.
 - 3) Check the defective for compressor wire single parts.
2. Check procedure

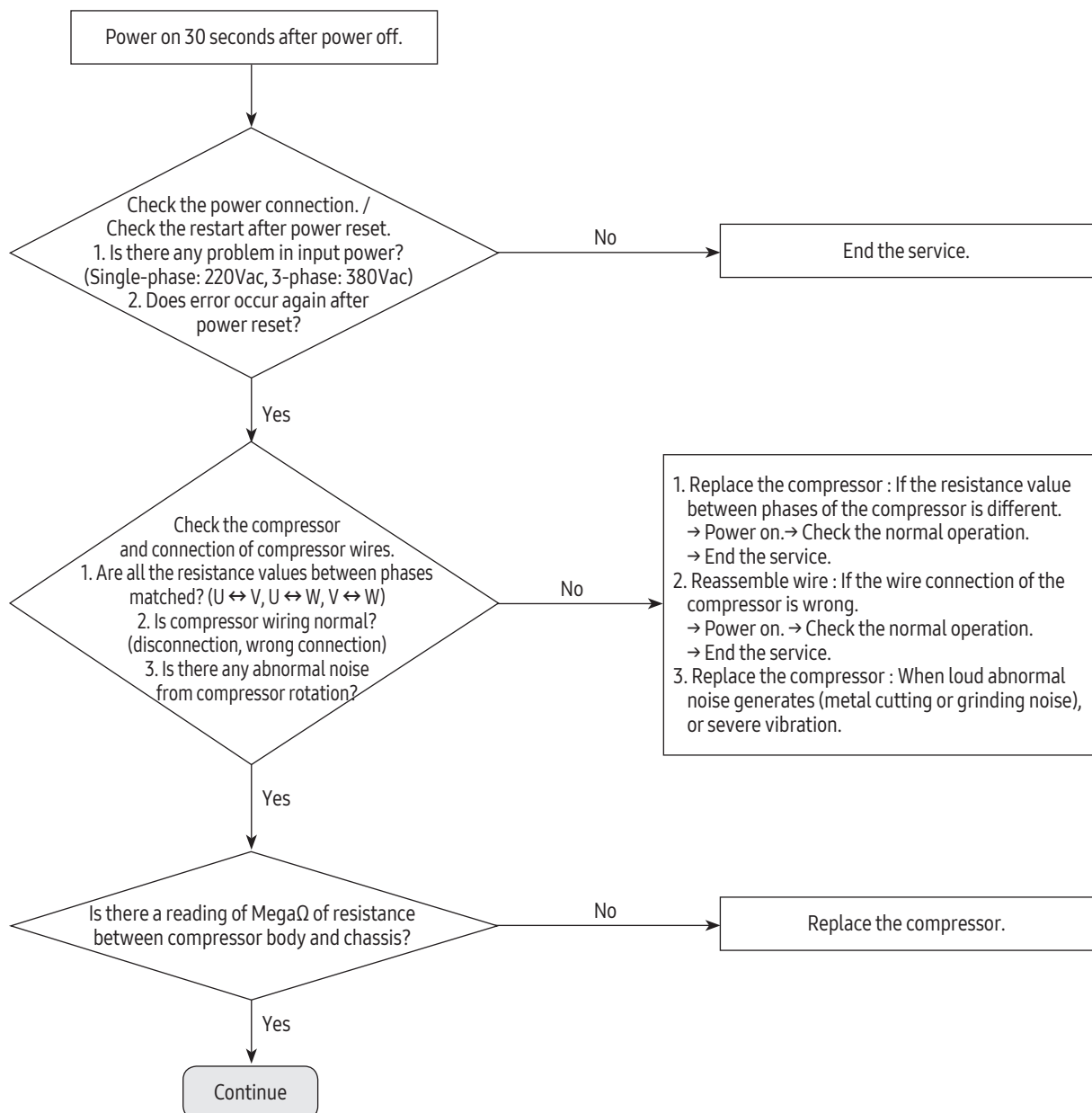

Compressor starting error / rotation error (Error Code : E461, E467) (cont.)

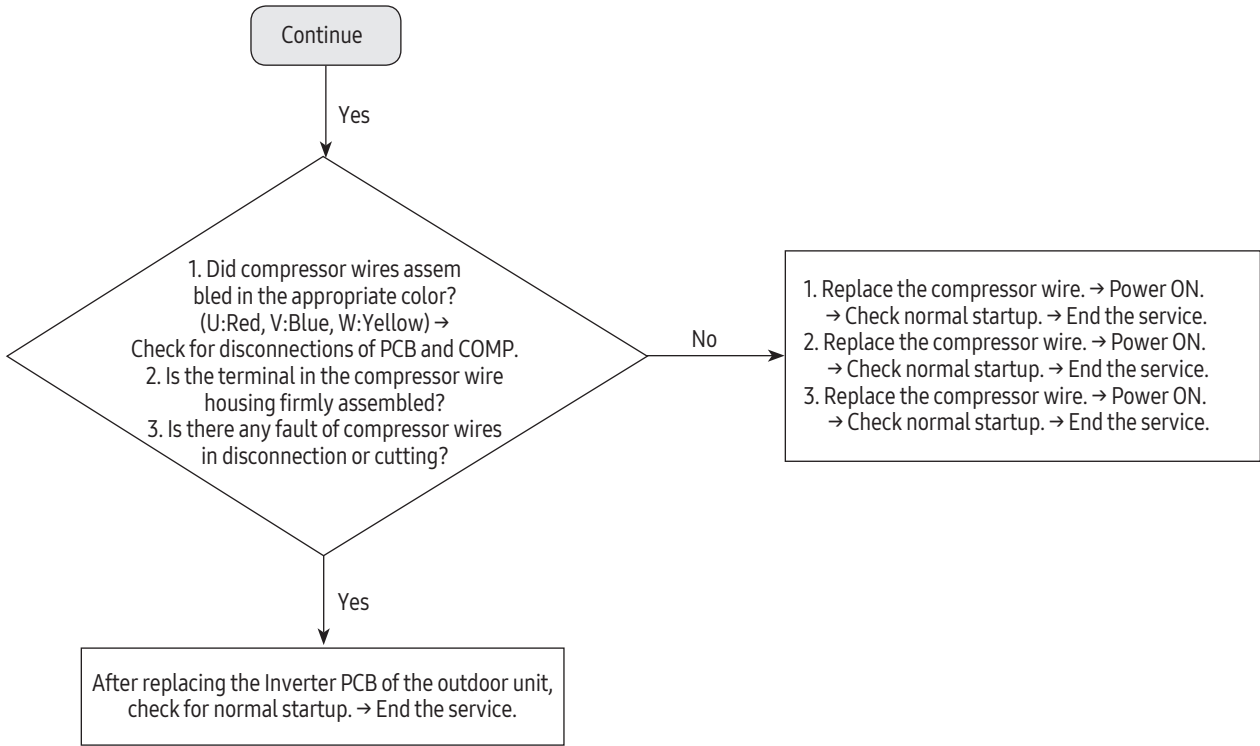

- ※ E461, E467 Error-related, EMI / outdoor unit Main / Indoor unit Main PCB do not replace!
→ This error is related to the compressor and Inverter PCB. (Not related to the above PCB)
- ※ Ensure that the service valve is open!
→ When the service valve is closed, the defects may be caused by differential pressure when starting the compressor.

4-3-16 Full current error / PFC over-current error (Error Code : E462, E484)

1. Test items
 - 1) Check the power connection. / Check the restart after power reset.
 - 2) Install outdoor unit and check environment.
 - Check for wire disconnection related to outdoor unit Inverter PCB and check the installation environment.
 - 3) Check the indoor unit installation environment.
 - 4) Check the opening of service valve.
2. Check procedure

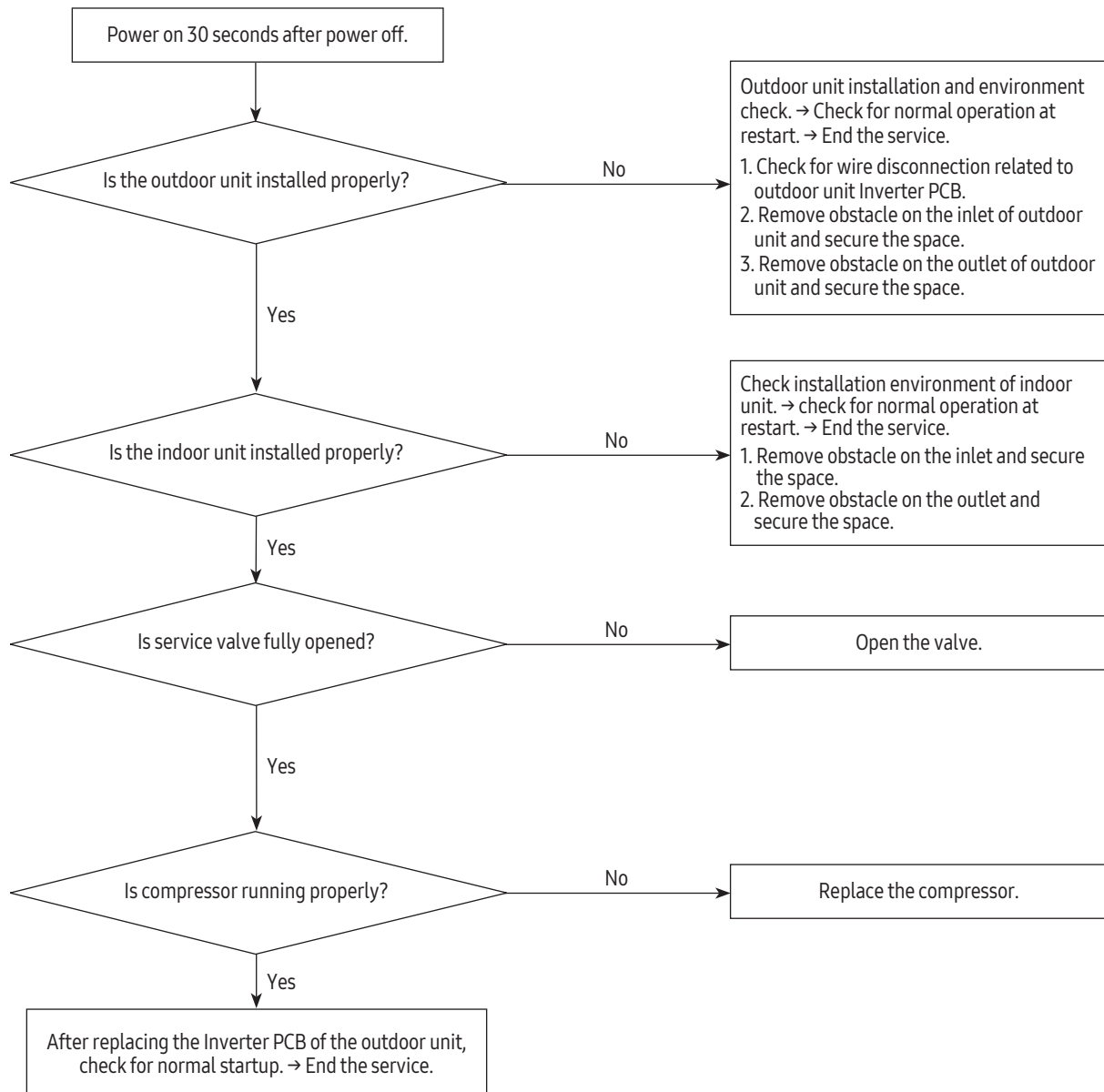

4-3-17 IPM over current error (Error Code : E464)

1. Test items
 - 1) Check the power connection. / Check the restart after power reset.
 - 2) Install outdoor unit and check environment.
 - Check for wire disconnection related to outdoor unit Inverter PCB and check the installation environment.
 - After having installed several units, please check that communication wires are not interchanged with piping.
 - 3) Check the indoor unit installation environment.
 - 4) Check the opening of service valve.
 - 5) Check the status of compressor assembly and wiring.
 - 6) Check the defective for compressor wire single parts.
2. Check procedure

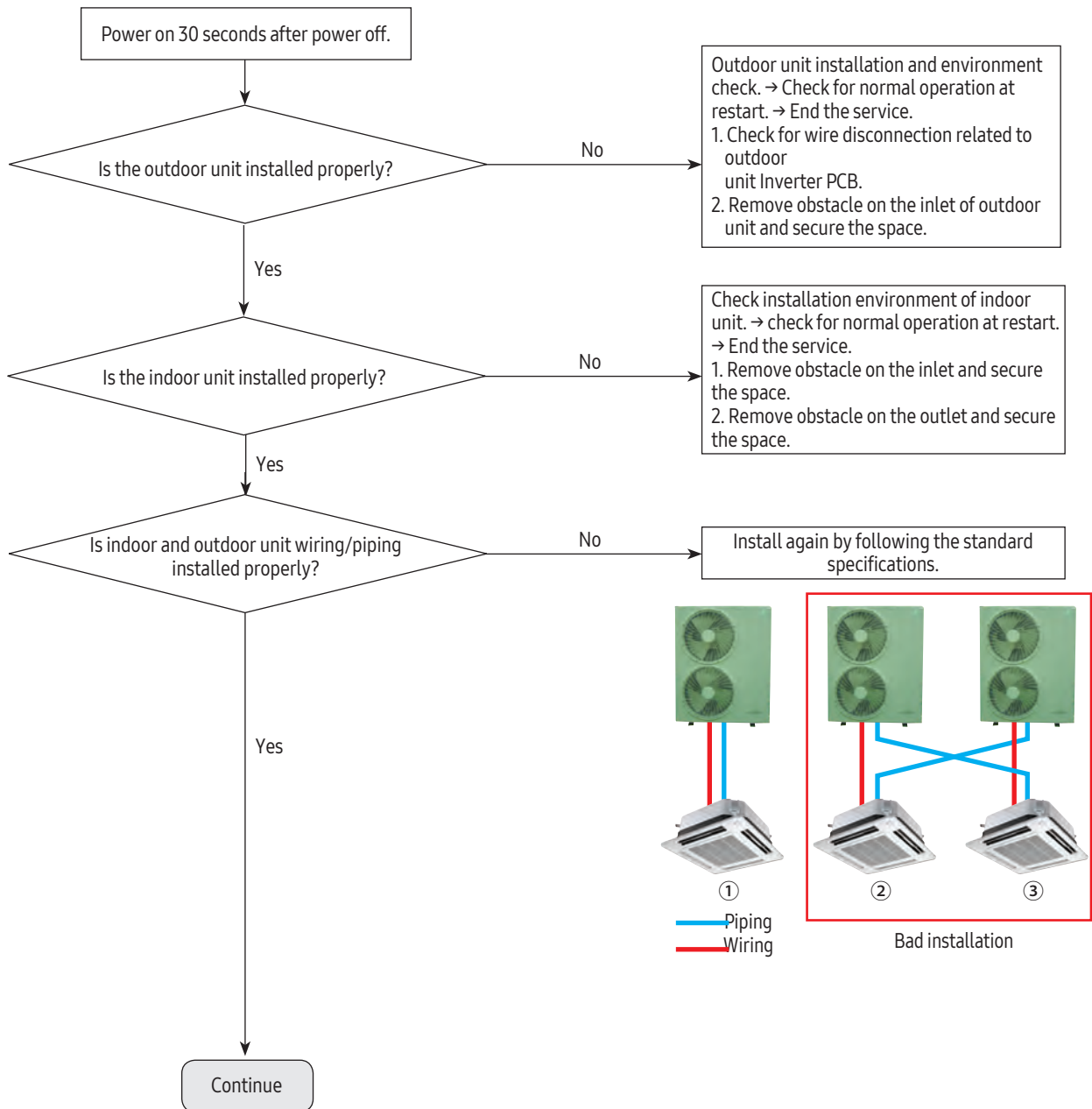

IPM over current error (Error Code : E464)(cont.)

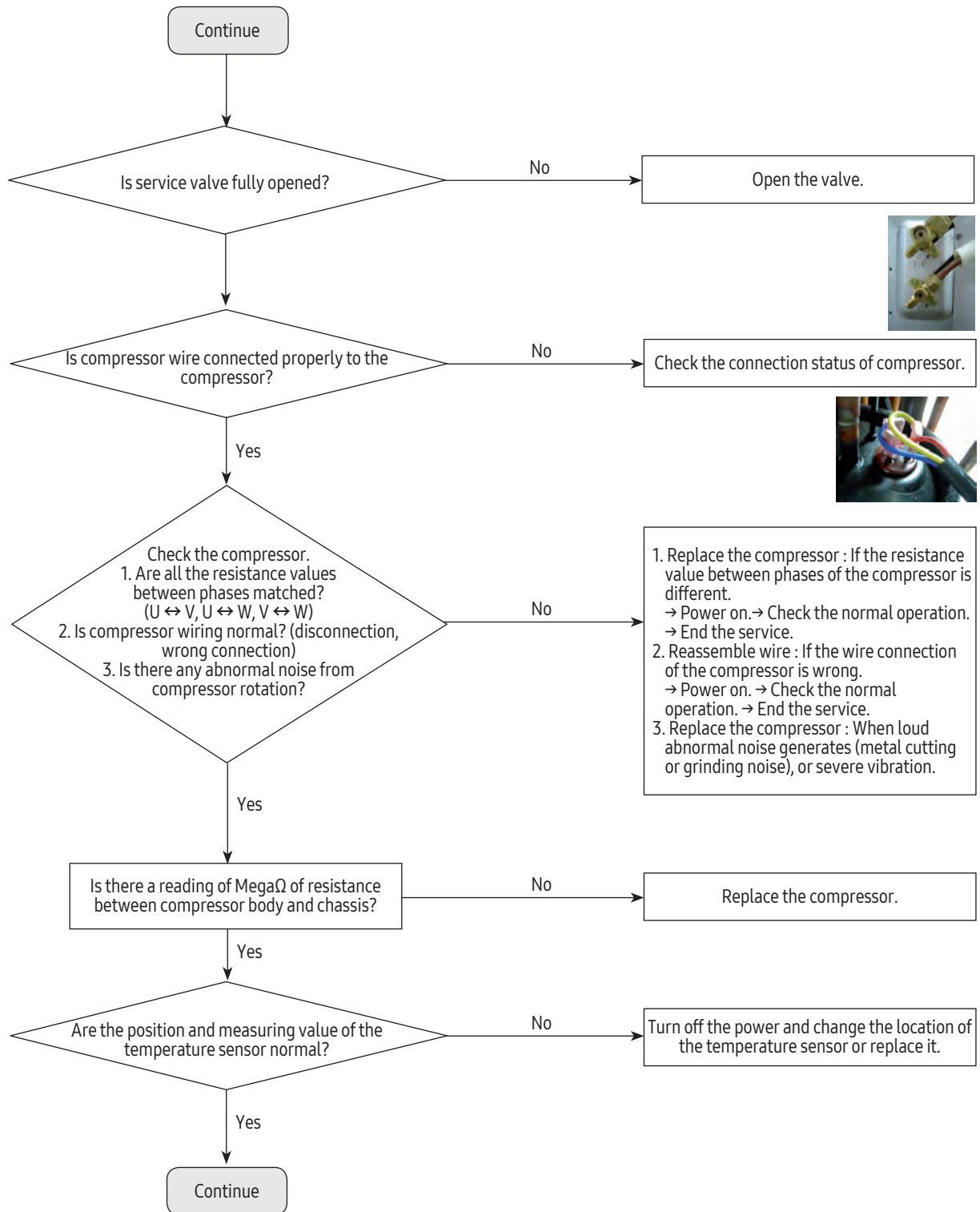

IPM over (Over Current) error (Error Code : E464)(cont.)

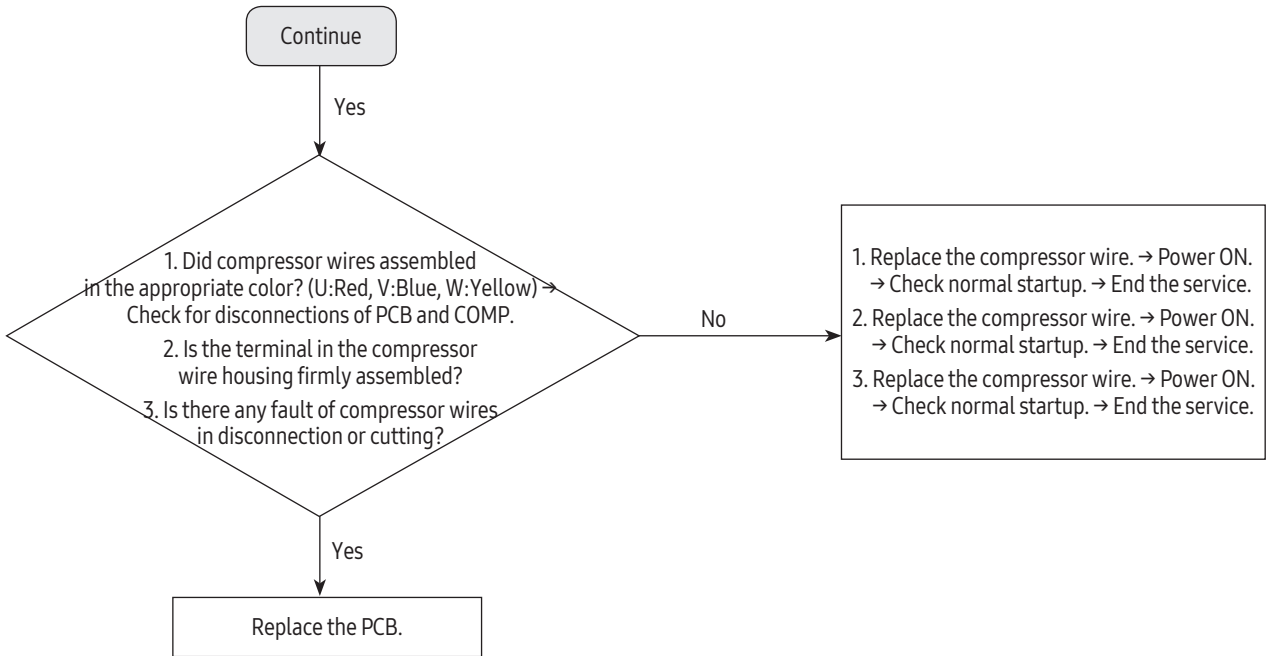

- ※ E46 Error-related, EMI / outdoor unit Main / Indoor unit Main PCB do not replace!
→ This error is related to the Inverter PCB. (Not related to the above PCB)
- ※ Ensure that the service valve is open!
→ When the service valve is closed, the defects may be caused by differential pressure when starting the compressor.

4-3-18 DC LINK over-current / low-voltage error (Error Code : E466) H/W DC_Link Over Voltage Error (Error Code : E483) AC Input Voltage Sensor Error (Error Code : E488)

1. Test items

- 1) Check the power connection. / Check the restart after power reset.
→ Is there a fault in input power? (Single-phase : 220Vac, 3-phase : 380Vac)
→ Does error occur again at operation after power is reset?
- 2) Check the connection of the power, and check whether the jointed power connection exists.
→ After having installed several units, please check that communication wires are not interchanged with piping.
- 3) Check the reactor and its connecting wires.
- 4) Check the fuses of EMI PBA.
- 5) Check the Terminal Block and Power Terminal Box and the wire assembly.

2. Check procedure

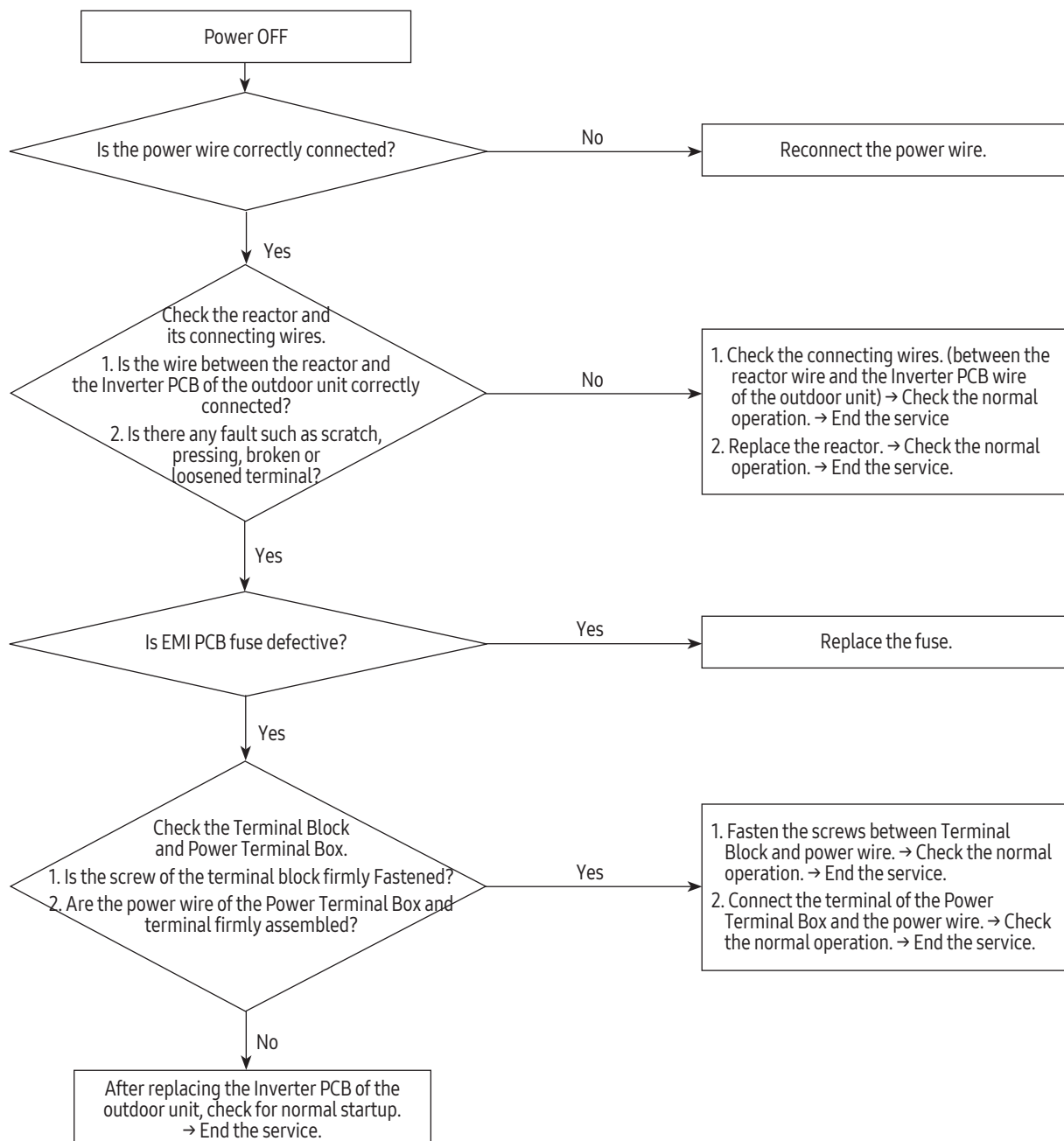

4-3-19 Gas leakage error (Error Code : E554)

1. Test items

- 1) Check the power connection. / Check the restart after power reset.
 - Is there a fault in input power? (Single-phase : 220Vac, 3-phase : 380Vac)
 - Does error occur again at operation after power is reset?
- 2) Check the compressor and the state of compressor wire assembling.
- 3) Check the outdoor unit installation environment.
 - Check for disconnection of the wires regarding the Inverter PCB of the outdoor unit and check the installation environment.
 - At the site where several units were installed at the same time, check whether communication wire and pipes have been wrongly connected!

2. Check procedure

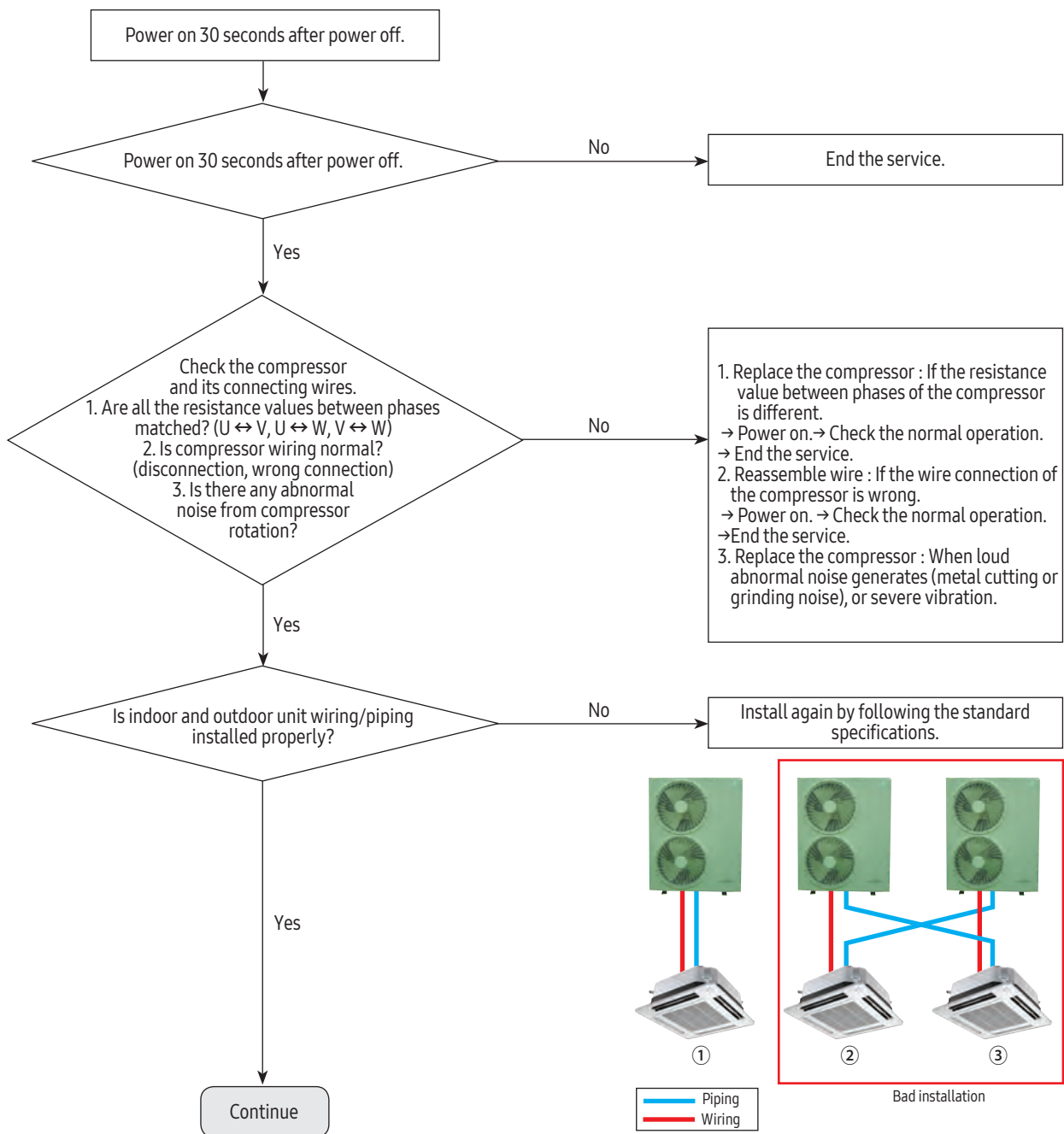

Gas leakage error (Error Code : E554)(Cont.)

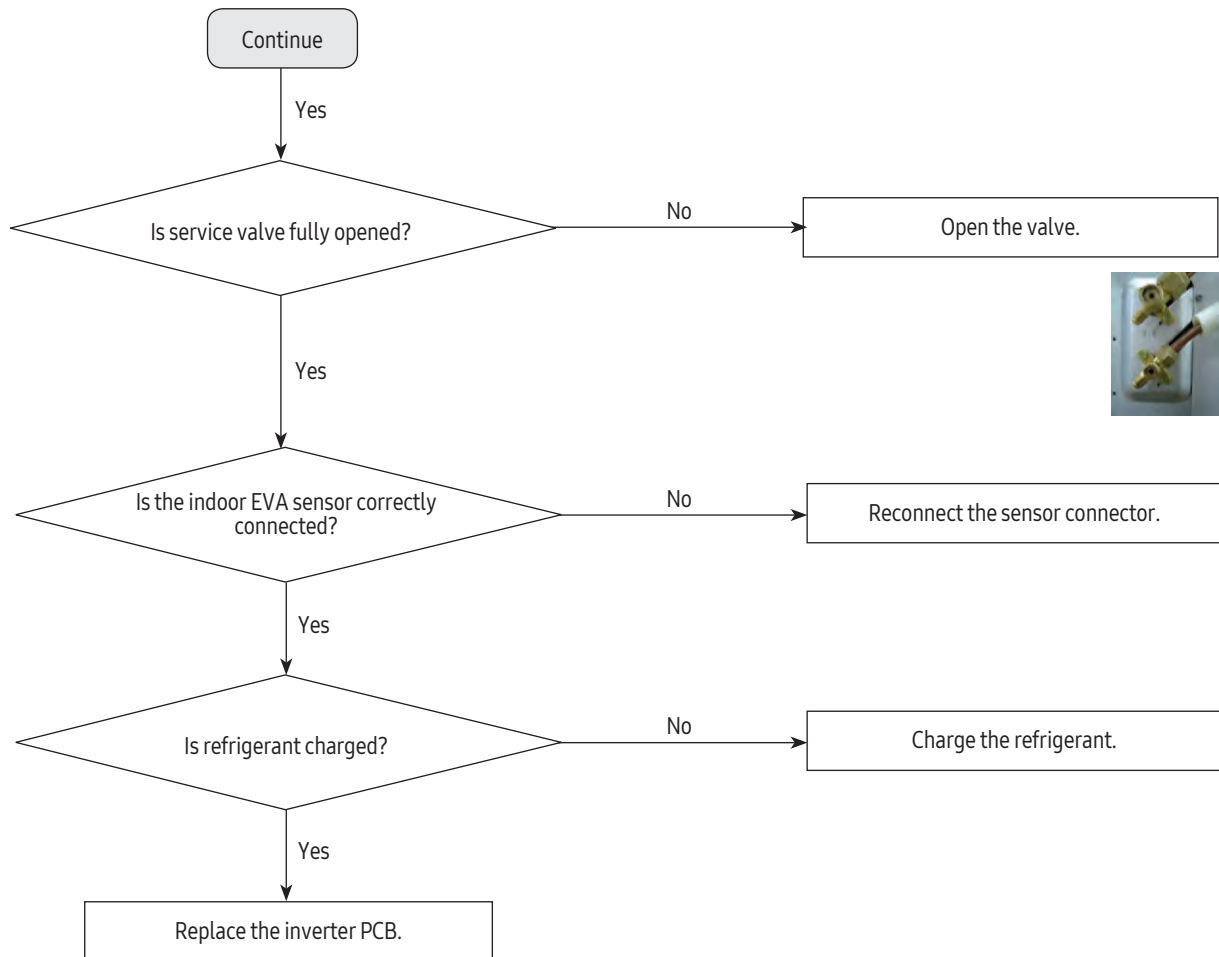

4-3-20 Pipe blockage error (Error Code : E422)

1. Test items
 - 1) Check the open state of the outdoor unit service valve.
 - 2) Check the connection of the pipe.
 - 3) Check the operation of the EEV.
 - 4) Check the refrigerant leakage.
 - 5) Check the connection of the indoor unit PBA EVA sensor.
 - 6) Check the fault in the indoor unit EVA sensor.
2. Check procedure

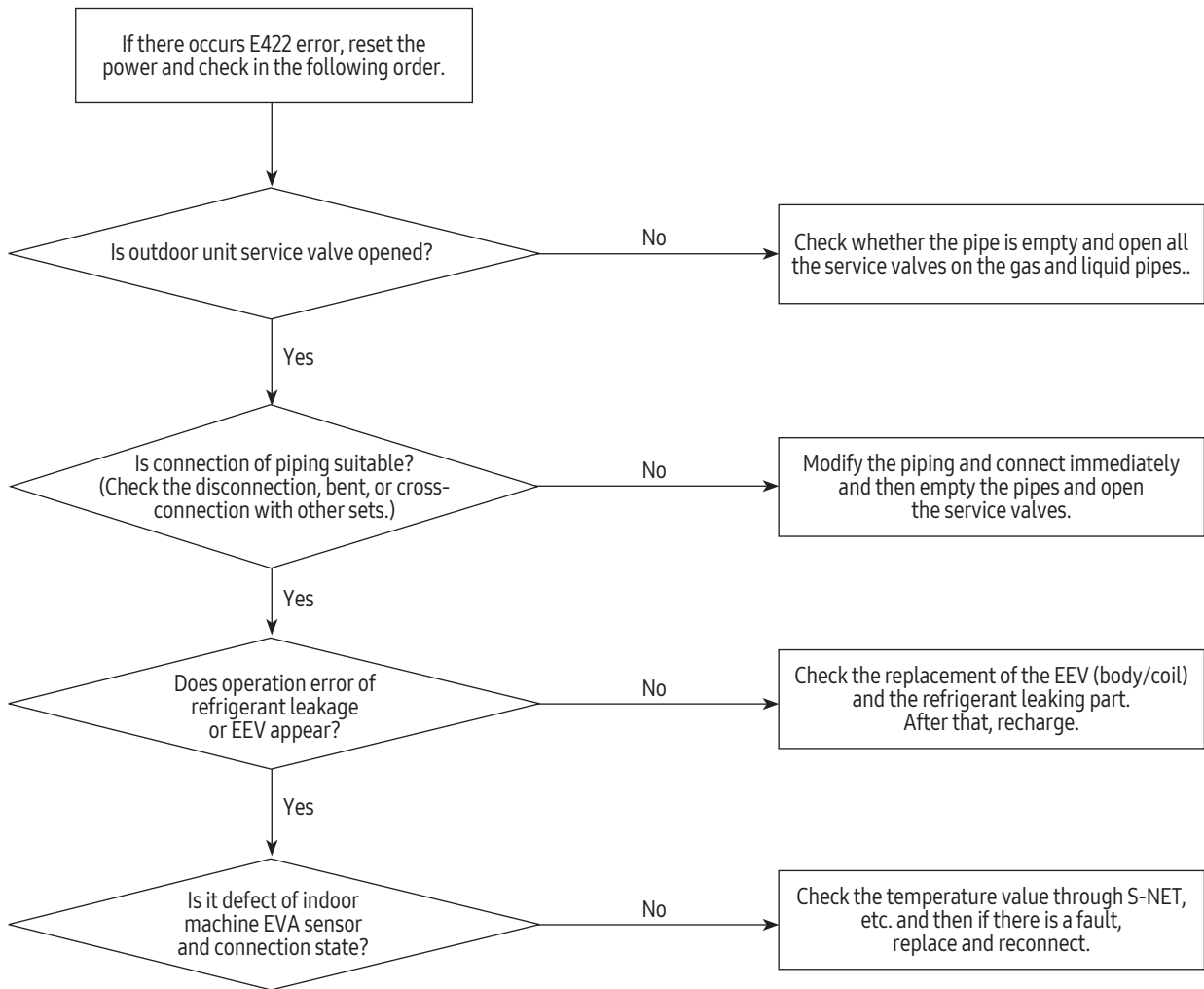

4-3-21 Smart install mode was not carried out (Error Code : E508)

Smart install mode?

When installing the air conditioner the first time, the installation status and fault status and performance of the product is a self-diagnostic function to determine comprehensively.

(The corresponding model is necessarily the general operation can be carried out when the smart install mode.)

Installation procedures of smart install mode

(1) Check the installation status of air conditioner.

- ▶ Check the power wire, communication wire, power connection, service valve opening, additional amount of refrigerant.
- ▶ When supplying power upon installation, a warning (error) of not having run in the installation smart install mode is displayed and the product will not run properly.

Model	Indoor unit	Outdoor unit
360 Cassette	Red lights up	E508

(2) Enter the smart install mode.

- ▶ Enter of the outdoor unit : Press for at the same time 5 seconds K 1, K 4 switches.
- ▶ Enter of the remote control : Press for at the same time 4 seconds [Power] + [Set] + [Mode] buttons.
- ▶ The progress status of installation smart install mode is shown in "00~99"(%).
- ▶ The smart install may take about 10 minutes.

Model	Indoor unit	Outdoor unit
360 Cassette	It is blinking in sequence. (Ice blue → Yellow green → Blue → Red → Ice blue)	"F" "F" "r" "d" After lasting for 3 minutes "F" "F" "00~99" display.

(3) The installation smart install mode is complete.

- ▶ Success in the installation smart install mode : The unit will enter a general operation standby mode upon blinking to show a success.

Indoor unit	Outdoor unit
Indicator light of main unit switches off.	"F" "F" "r" "F" After blinking for 10 seconds. It will enter the general operation stand by mode.

- ▶ Smart Install failure: Error code blink

※ In the event of Error Error code reference, please carry a house from scratch after an action mode for the Smart Install Error.

Precautions

- ▶ When needing to have additional piping before entering the installation smart install mode, charge refrigerant additionally according to the manual. At this time, it is possible to run the cooling test (K2 switch once) and heating test (K1 switch once).
 - ▶ When the installation smart Install mode is not run, the remote control and main unit button will not work. [E508 (Smart install mode was not carried out) error displayed.]
 - ▶ The installation smart install mode operation may be interrupted by pressing the K3 switch. [Display the E508 (Smart install mode was not carried out) error upon interruption.]
 - ▶ While running in the installation smart install mode, the installation smart Install mode operation may not be interrupted even by pressing the K1 or K2 switch.
 - ▶ While running in the installation smart install mode, the system status information may be checked by pressing the K4 switch.
 - ▶ When pressing the K1 and K4 switches for 5 seconds upon successfully running in the installation smart install mode, the system will run the installation smart install mode again.
 - ▶ When having an error in the installation smart install mode, operation in the installation smart install mode may be interrupted. Please run the installation smart install mode again upon taking appropriate action for the error. (Refer to troubleshooting)
 - ▶ When the installation smart install mode is not completed successfully even after resolving all the errors, the unit will not work, displaying an error code of E508 (Smart install mode was not carried out). Upon resolving the problem, try to complete running the installation smart install mode.
- ※ Displayed E508 is not a malfunction, it is indication that did not carried out the smart Install mode after air conditioner installation.

4-3-22 Others

1. EEPROM option error (E163) : Reset the options.
2. Temperature fuse error : E198
 - If the Terminal Box temperature rise fuse is disconnected, replace the PCB.
 - Check the wiring connector of temperature fuse.
3. Current sensor error : Upload EEPROM to the Main PCB of the outdoor unit.
 - After checking for normal operation of PCB, replace the inverter PCB.
4. Compressor Vlimit error : E465
 - If the compressor is abnormally run, replace the compressor and then ensure that it works normally.
 - If the compressor is normally run, check the assembling between the heatproof plate and the Inverter PCB and then if there is no abnormality, replace the Inverter PCB.
5. DC link voltage sensor error : E469
 - Error occurs when DC LINK value is not normal (DC LINK VOLTAGE: 280~320V)
 - Check the value of DC link when error occurs and check the reactor disconnection
6. EEPROM read/write error : E470
 - Error occurs when there is no EEPROM data in the set.
 - Check the model name and insert EEPROM for corresponding model or load the EEPROM data.
7. Input current sensor error : E485
 - Detect the input sensor while the set is in stop status to check if there's any problem.
 - When error occurs, turn on/off the power for number of time and if same error occurs while the power is off, replace the Inverter PCB.
8. OTP error : E471
 - Upload EEPROM to the Main PCB of the outdoor unit.
9. Capacity inconsistency error : E556
 - Check the model name between the outdoor and indoor unit and re-enter the option code to the indoor unit.
10. 3-phase power wire disconnection : E424
 - Check for disconnection of the 3-phase (open) power wire, and check the disconnected EMI PBA fuse.
11. Outdoor unit freezing detection (at the stop of the compressor) : E403
Outdoor overload protection control (at the stop of the compressor) : E404
 - Check whether the fan and the motor operate normally.
 - Check the operation of EEV.
 - Check the temperature sensor of the indoor unit heat exchanger.
 - Check the indoor unit inlet blockage.
12. Outdoor unit compressor discharging temperature protection control : E416
 - Check for lack of refrigerant.
 - Check the blockage of the solenoid valve.
 - Check the malfunction of the exhaust temperature sensor.
 - Check the EEV.
13. Error of impossibility to operate heating at outdoor temperature exceeding 30°C : E440
Error of impossibility to operate cooling at outdoor temperature of -5°C or under : E441
 - It is not the error code in the product and it is a specification to protect the product by limiting the temperature scope of use.
 - Use by referring to the temperature scope of use on the product manual, etc.
14. OLP overheating and compressor stop : E463
 - Check the opening of the sub valve.
 - Check the amount of the cooling water.
 - Check the OLP sensor.

15. Current sensor error : E468
 - Check the EEPROM data.
 - Check the PCB operation.

16. IPM (IGBT Module) or PFCM temperature sensor error : E474
IPM overheat error for outdoor unit inverter compressor : E500
 - Check whether IPM is correctly assembled on the heatproof plate.
 - Check whether the inlet is blockage.
 - If there is a defect, replace the IPM.

5. PCB Diagram and Parts List

5-1 Indoor Unit

5-1-1 MAIN PCB

- AC026/035RN1DKG
- AC052/071RN4DKG
- AC052/071RNCDKG
- AC026/035/052/071RNNDKG

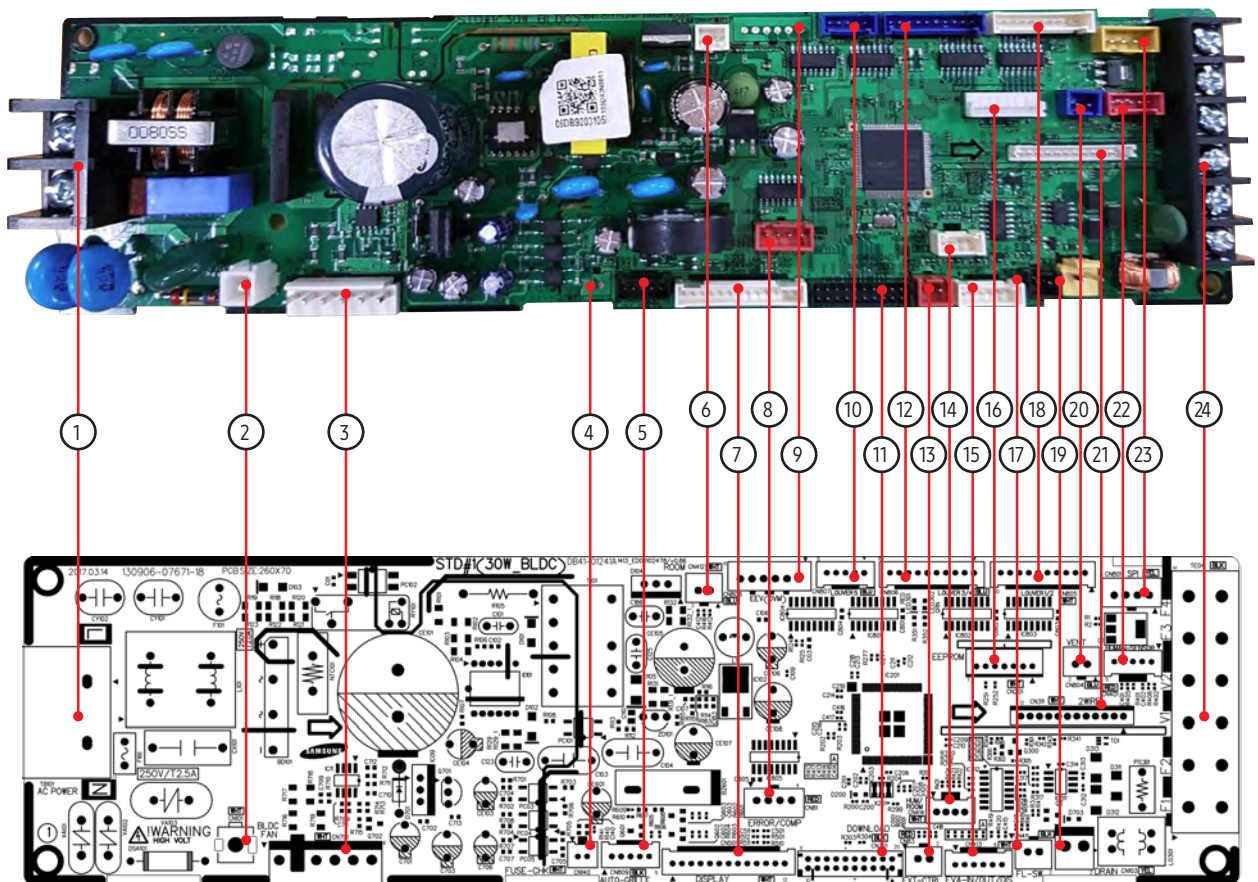

This Document can not be used without Samsung's authorization.

<p>① TB101-AC POWER #1: AC POWER (L) #2: AC POWER (N)</p>	<p>② CN101-EARTH #1: EARTH</p>	<p>③ CN701-BLDC MOTOR #1: DC310V #3 : GND #4 : DC15V #5 : FAN RPM #6 : RPM FEEDBACK</p>	<p>④ CN140-FUSE CHECK #1: FUSE CHECK Signal #2: GND</p>	<p>⑤ CN809-AUTO GRILLE #1 : DC12V #4 : REMOCON OUT #5 : GND</p>
<p>⑥ CN412-ROOM SENSOR #1 : ROOM SENSOR #2 : GND</p>	<p>⑦ CN501-DISPLAY #1: DC12V #2: LED_0 #3: LED_1 #4: LED_2 #5: LED_3 #6: LED_4 #7: LED_5 #8: REMOCON OUT #9 : AUTO SWITCH #10: REMOCON IN #11: GND #12: DC5V #13: GND</p>	<p>⑧ CN81-COMP/ERROR MONITOR #1: DC12V #2: ERROR OUT (GND) #3: DC12V #4: COMP/OPER. OUT (GND)</p>	<p>⑨ CN808-EEV #1~#4: EEV SIGNAL #5 : DC12V #6 : DC12V</p>	<p>⑩ CN807-LOUVER5 #1 : DC12V #2~#5: LOUVER SIGNAL</p>
<p>⑪ CN301-DOWNLOAD</p>	<p>⑫ CN806-LOUVER3/4 #1 : DC12V #2~#5: LOUVER SIGNAL #6 : DC12V #7~#10: LOUVER SIGNAL</p>	<p>⑬ CN83-EXT CTRL #1: GND #2: EXTERNAL CONTROL SIGNAL</p>	<p>⑭ CN414-HUMIDITY SENSOR #1 : DC5V #2 : GND #3 : THERMISTOR SENSOR #4 : HUMIDITY SENSOR</p>	<p>⑮ CN413:THERMISTOR #1 : EVA-IN SENSOR #2 : GND #3 : EVA-OUT SENSOR #4 : GND #5 : DISCHARGE SENSOR #6 : GND</p>
<p>⑯ CN201-EEPROM #1: GND #3: DC5V #4: EEPROM_SELECT #5: EEPROM_SO #6: EEPROM_SI #7: EEPROM_CLK</p>	<p>⑰ CN411-FLOAT SWITCH #1: FLOAT SWITCH SIGNAL #2: GND</p>	<p>⑱ CN805-LOUVER1/2 #1 : DC12V #2~#5: LOUVER SIGNAL</p>	<p>⑲ CN103-DRAIN PUMP #1: DRAIN PUMP (DC12V) #2: GND</p>	<p>⑳ CN804-VENTILATOR #1: DC12V #2: VENT SIGNAL OUTPUT(GND)</p>
<p>㉑ CN311-2 WIRED SUB</p>	<p>㉒ CN401-HUMAN SENSING #1: DC12V #2: MAIN-HUMAN SENSOR COMM(TXD) #3: MAIN-HUMAN SENSOR COMM(RXD) #4: GND</p>	<p>㉓ CN801-SPI #1: GND #2: GND #3: SPI SIGNAL (DC12V)</p>	<p>㉔ TE04-COMMUNICATION #1: COM1(F1) #2: COM1(F2) #3: V1(DC12V) #4: V2(GND) #5: COM2(F3) #6: COM2(F4)</p>	

■ AC071RN4PKG

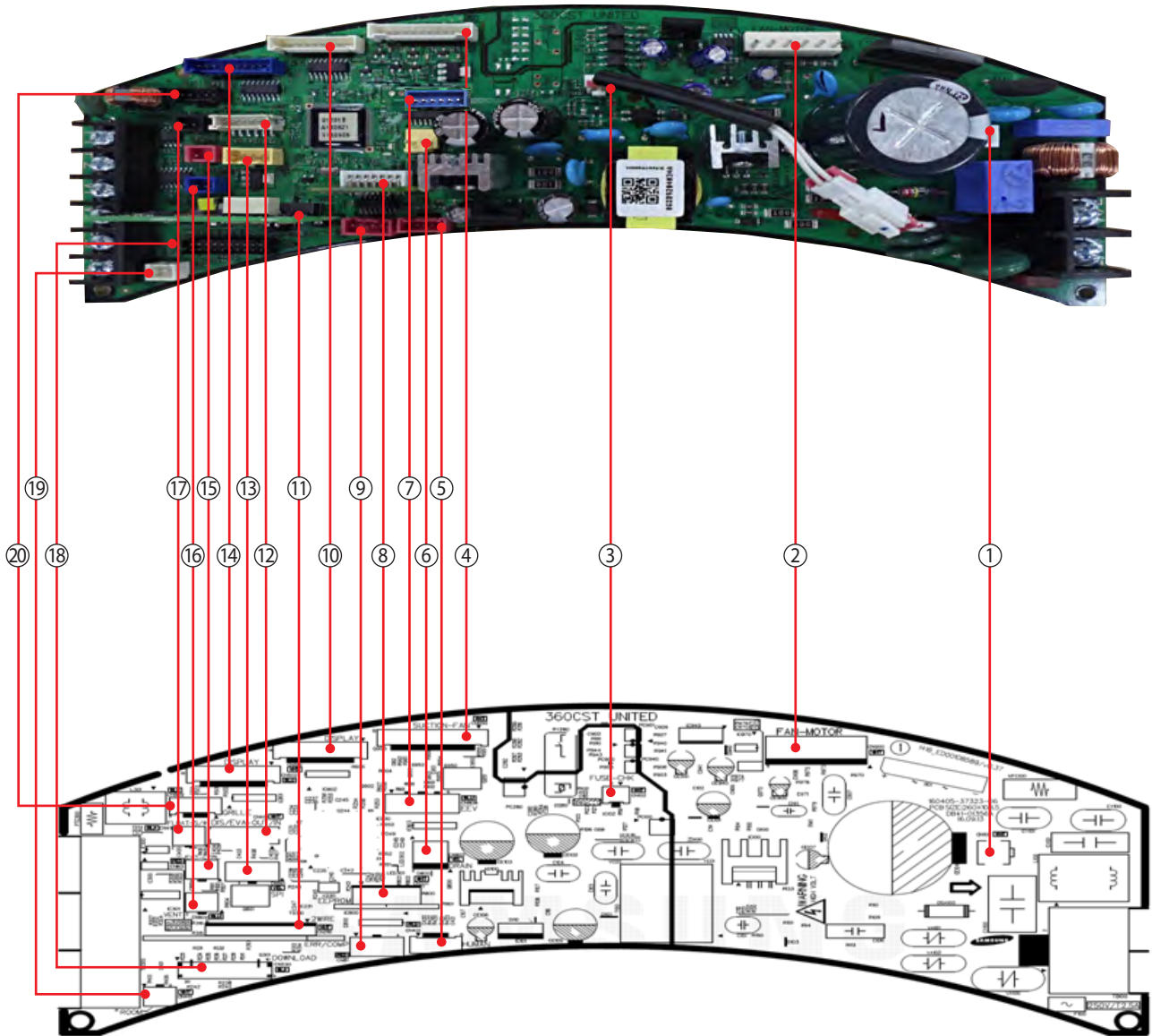

This Document can not be used without Samsung's authorization.

<p>① CN101-EARTH GND #1: EARTH GND</p>	<p>② CN900-BLDC MOTOR #1: DC310V #3: GND #4: DC15V #5: FAN RPM #6: RPM FEEDBACK</p>	<p>③ CN102-FUSE CHECK #1: FUSE CHECK SIGNAL #2: GND</p>	<p>④ CN950-SUCTION FAN #1,#5 #9: DC12V #2 #6 #10: FAN FEEDBACK #3 #7 #11: GND #4 #8 #12: FAN CTRL</p>
<p>⑤ CN401-HUMAN SENSING SENSOR #1: DC12V #2: HUMAN SENSING SENSOR COMM(TXD) #3: HUMAN SENSING SENSOR COM(M(RXD)) #4: GND</p>	<p>⑥ CN802-DRAIN PUMP #1: D/P POWER(DC12V) #2: GND</p>	<p>⑦ CN808-EEV #1~#4: EEV SIGNAL OUTPUT #5: DC12V #6: DC12V</p>	<p>⑧ CN201-EEPROM #1: GND #3: DC5V #4: EEPROM_SHEET #5: EEPROM_SO #6: EEPROM_SI #7: EEPROM_CLK</p>
<p>⑨ CN81-ERROR/COMP CHECK #1: DC12V #2: ERROR SIGNAL OUTPUT(GND) #3: DC12V #4: COMP/OPER. SIGNAL OUTPUT(GND)</p>	<p>⑩ CN501-DISPLAY #1: BUZZER1 #2: BUZZER2 #3: LED1 #4: LED2 #5: LED3 #6: LED4 #7: LED5 #8: LED6 #9: LED7 #10: LED8</p>	<p>⑪ CN310-2WIRED REMOCON #1: DC12V #2: COM2_PCTRL_MICOM #3: COM2_VCHECK_A #4: COM2_VCHECK_B #5: COM2_MICOM_AD #6: DC5V #8: COM2_C #9: COM2_D #10: COM2_TXD #11: COM2_RXD #12: GND</p>	<p>⑫ CN413-THERMISTOR #1: EVA-IN THERMISTOR #2: GND #3: EVA-OUT THERMISTOR #4: GND #5: DISCHARGE THERMISTOR #6: GND</p>
<p>⑬ CN810-SPI #1: GND #2: GND #3: SPI POWER OUTPUT(DC12V)</p>	<p>⑭ CN502-DISPLAY #1: 12V #2: LED9 #3: LED10 #4: LED11 #5: LED12 #6: LED13 #7: REMOCON OUTPUT SIGNAL #8: REMOCON INPUT SIGNAL #9: GND #10: DV5V</p>	<p>⑮ CN83-EXT CTRL #1: GND #2: EXT-CTRL SIGNAL</p>	<p>⑯ CN804-VENTILATOR #1: DC12V #2: VENTILATOR SIGNAL OUTPUT(GND)</p>
<p>⑰ CN411-FLOATS/W #1: F/S SIGNAL #2: GND</p>	<p>⑱ CN230-DOWNLOAD</p>	<p>⑲ CN412-ROOM SENSOR #1: INDOOR THERMISTOR #2: GND</p>	<p>㉑ CN809-AUTO GRILL #1: DC12V #4: REMOCON SIGNAL #5: GND</p>

■ AC026/035/052/071RNADKG

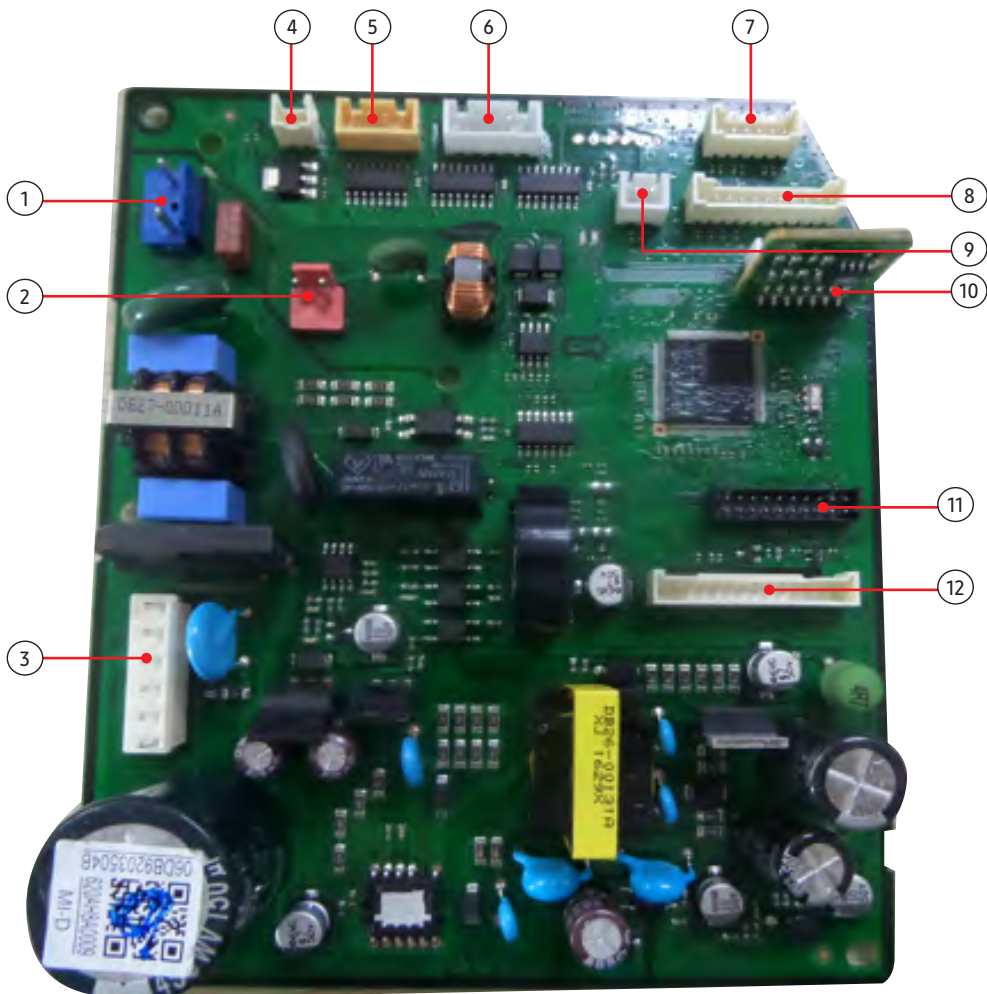

This Document can not be used without Samsung's authorization.

<p>① CNP101-POWER #1 : L #2 : NOT USED #3 : N</p>	<p>② CN303-COM1 #1~2 : COMMUNICATION SIGNAL</p>	<p>③ CN701-BLDC FAN #1 : DC 310V #2 : NOT USED #3 : GND #4 : PWM SIGNAL #5 : FEEDBACK SIGNAL</p>	<p>④ CN140-FUSE CHECK #1 : THERMAL FUSE SIGNAL #2 : GND</p>
<p>⑤ CN805-SPI #1~2 : GND #3 : SPI CONTROL SIGNAL #4 : NOT USED</p>	<p>⑥ CN802-STEP UP/DOWN #1 : DC 12V #2~5 : LOUVER SIGNAL</p>	<p>⑦ CN403-EVA IN/OUT/DIS #1 : EVA IN TEMPERATURE SENSOR SIGNAL #2 : GND #3 : EVA OUT TEMPERATURE SENSOR SIGNAL #4 : GND #5 : DISCHARGE TEMPERATURE SENSOR SIGNAL #6 : GND</p>	<p>⑧ CN501-DISPLAY #1~3 : LED SIGNAL #4 : REMOCON SIGNAL #5 : GND #6 : DC 5V #7~8 : REMOCON SIGNAL #9~11 : NOT USED</p>
<p>⑨ CN401-ROOM #1 : OOM TEMPERATURE SENSOR SIGNAL #2 : GND</p>	<p>⑩ CN201-EEPROM #1 : GND #2 : NOT USED #3 : DC 5V #4~7 : EEPROM SIGNAL</p>	<p>⑪ CN302-DOWNLOAD #1~8 : DOWNLOAD SIGNAL #9 : GND #10~11 : DC 5V #12~16 : DOWNLOAD SIGNAL #17 : GND #18~20 : DOWNLOAD SIGNAL</p>	<p>⑫ CN301-to 2WIRE SUB #1~2 : COMMUNICATION SIGNAL #3~4 : SUB PBA SIGNAL #5 : EXTERNAL CONTROL SIGNAL #6 : COMP CHECK SIGNAL #7 : ERROR CHECK SIGNAL #8 : DC 5V #9 : GND #10 : DC 12V #11~14 : COMMUNICATION SIGNAL</p>

■ AC026/035/052/071RNLDKG

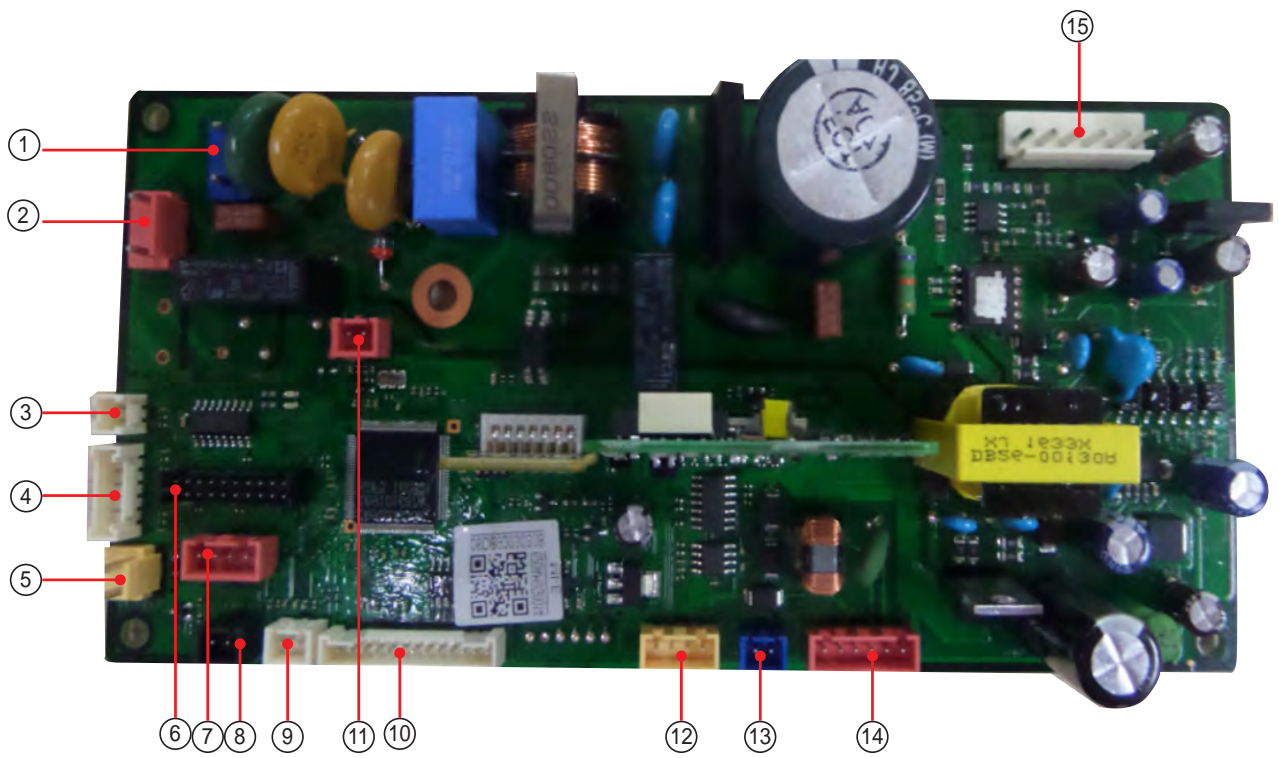

<p>① CN101 : POWER #1 : L #2 : NOT USED #3 : N</p>	<p>② CN702 : HOT COIL #1 : N #2 : NOT USED #3 : L</p>	<p>③ CN140 : FUSE CHECK #1 : THERMAL FUSE SIGNAL #2 : GND</p>	<p>④ CN413 : EVA IN/OUT/DIS #1 : EVA IN TEMPERATURE SENSOR SIGNAL #2 : GND #3 : EVA OUT TEMPERATURE SENSOR SIGNAL #4 : GND #5 : DISCHARGE TEMPERATURE SENSOR SIGNAL #6 : GND</p>
<p>⑤ CN103 : DRAIN PUMP #1 : DRAIN PUMP SIGNAL #2 : GND</p>	<p>⑥ CN301 : SW DOWNLOAD -</p>	<p>⑦ CN81 : ERROR/COMP CHECK #1 : DC12V #2 : ERROR OUT SIGNAL #3 : DC12V #4 : COMP/ERROR OUT SIGNAL</p>	<p>⑧ CN411 : FLOAT SWITCH #1 : FLOAT SWITCH SIGNAL #2 : GND</p>
<p>⑨ CN412 : ROOM #1 : ROOM SENSOR SIGNAL #2 : GND</p>	<p>⑩ CN501 : DISPLAY #1 : DC12V #2 : LED_0 #3 : LED_1 #4 : LED_2 #5 : LED_3 #6 : LED_4 #7 : BUZZER OUTPUT #8 : REMOCON SIGNAL OUTPUT #9 : AUTO SWITCH #10 : REMOCON SIGNAL INPUT #11 : GND #12 : DC5V #13 : BUZZER OUTPUT</p>	<p>⑪ CN83 : EXT_CTRL #1 : GND #2 : EXT-CTRL SIGNAL</p>	<p>⑫ CN801 : SPI #1 : GND #2 : GND #3 : SPI SIGNAL #4 : NOT USED</p>
<p>⑬ CN804 : VENT #1 : DC12V #2 : VENTILATOR SIGNAL OUTPUT(GND)</p>	<p>⑭ CN302 : COMM #1 : COM1(F1) #2 : COM1(F2) #3 : V1(DC12V) #4 : V2(GND) #5 : COM2(F3) #6 : COM2(F4)</p>	<p>⑮ CN703 : BLDC FAN #1 : DC310V #3 : GND #4 : DC15V #5 : FAN RPM #6 : RPM EFFDBACK</p>	

■ AC035/052/071RNMDKG

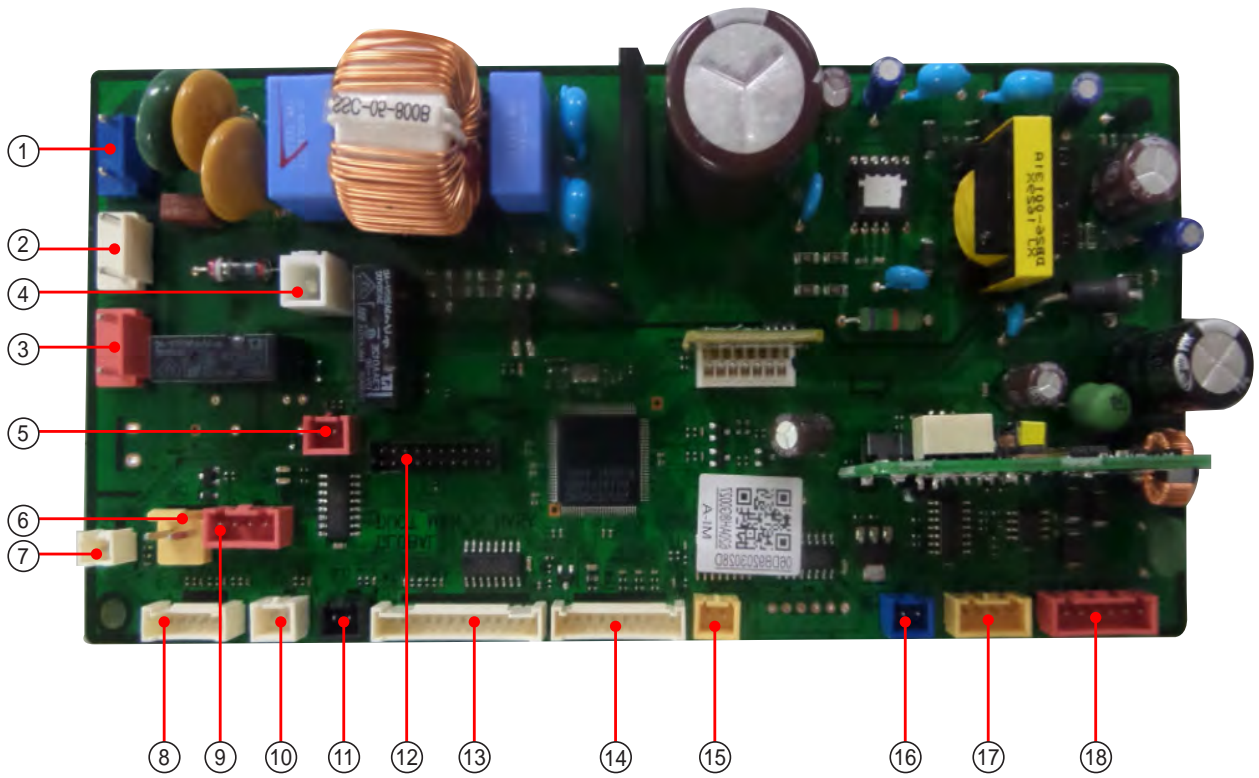

This Document can not be used without Samsung's authorization.

<p>① CN101 : POWER #1 : L #2 : NOT USED #3 : N</p>	<p>② CN906 : BLDC PBA POWER #1 : N #2 : NOT USED #3 : L</p>	<p>③ CN702 : HOT COIL #1 : N #2 : NOT USED #3 : L</p>	<p>④ CN1 : EARTH -</p>
<p>⑤ CN83 : EXT_CTRL #1 : GND #2 : EXT-CTRL SIGNAL</p>	<p>⑥ CN701 : DRAIN PUMP #1 : DRAIN PUMP SIGNAL #2 : GND</p>	<p>⑦ CN140 : FUSE CHECK #1 : THERMAL FUSE SIGNAL #2 : GND</p>	<p>⑧ CN413 : EVA IN/OUT/DIS #1 : EVA IN TEMPERATURE SENSOR SIGNAL #2 : GND #3 : EVA OUT TEMPERATURE SENSOR SIGNAL #4 : GND #5 : DISCHARGE TEMPERATURE SENSOR SIGNAL #6 : GND</p>
<p>⑨ CN81 : ERROR/COMP CHECK #1 : DC12V #2 : ERROR OUT SIGNAL #3 : DC12V #4 : COMP/ERROR OUT SIGNAL</p>	<p>⑩ CN412 : ROOM #1 : ROOM SENSOR SIGNAL #2 : GND</p>	<p>⑪ CN411 : FLOAT SWITCH #1 : FLOAT SWITCH SIGNAL #2 : GND</p>	<p>⑫ CN301 : SW DOWNLOAD -</p>
<p>⑬ CN501 : DISPLAY #1 : DC12V #2 : LED_0 #3 : LED_1 #4 : LED_2 #5 : LED_3 #6 : LED_4 #7 : BUZZER OUTPUT #8 : REMOCON SIGNAL OUTPUT #9 : AUTO SWITCH #10 : REMOCON SIGNAL INPUT #11 : GND #12 : DC5V #13 : BUZZER OUTPUT</p>	<p>⑭ CN905 : TO BLDC PBA SIGNAL #1 : DC12V #2 : GND #3 : DC5V #4 : BLDC POWER RELAY #5 : OVER_TEMP #6 : IPM_FAULT #7 : REVERSE_OUT #8 : FAN FEEDBACK #9 : INRUSH_OUT #10 : FAN_PWM</p>	<p>⑮ CN907 : UART COMM. #1 : MAIN_RXD_INV_TXD #2 : MAIN_TXD_INV_RXD</p>	<p>⑯ CN804 : VENT #1 : DC12V #2 : VENTILATOR SIGNAL OUTPUT(GND)</p>
<p>⑰ CN801 : SPI #1 : GND #2 : GND #3 : SPI SIGNAL #4 : NOT USED</p>	<p>⑱ CN302 : COMM. #1 : COM1(F1) #2 : COM1(F2) #3 : V1(DC12V) #4 : V2(GND) #5 : COM2(F3) #6 : COM2(F4)</p>		

5-1-2 Display PCB

■ AC026/035RN1DKG

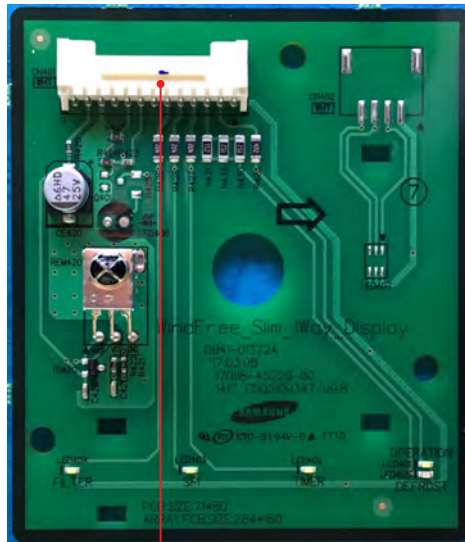

①

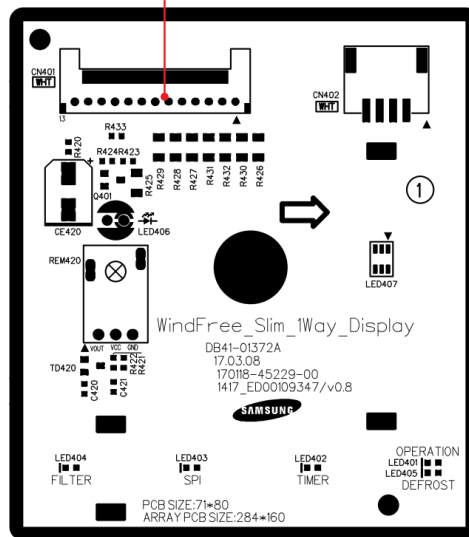

①

① CN401-DISPLAY	
#1:	DC12V
#2:	LED_0
#3:	LED_1
#4:	LED_2
#5:	LED_3
#6:	LED_4
#7:	-
#8:	REMOCON Signal Out
#9 :	PANEL SELECTION
#10:	REMOCON Signal In
#11:	GND
#12:	DC5V
#13:	-

This Document can not be used without Samsung's authorization.

■ AC052/071RN4DKG,
AC026/035/052/071RNNDKG

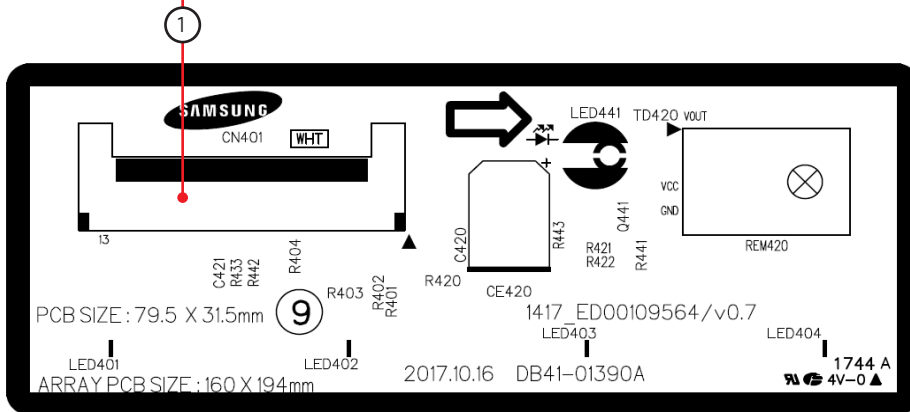
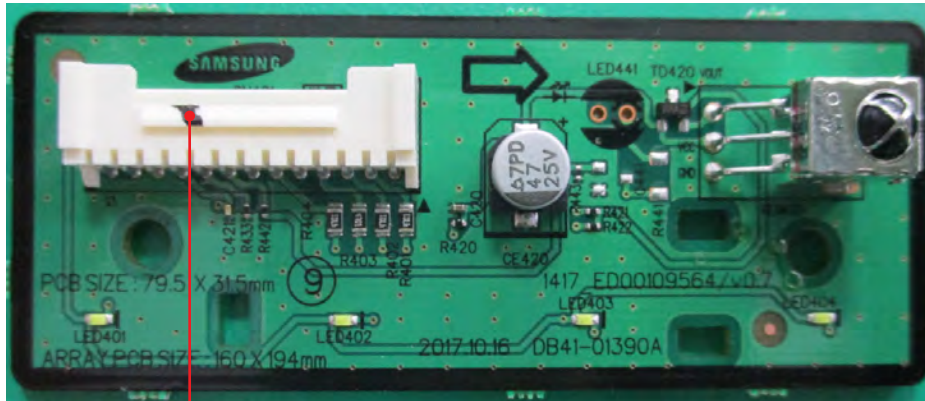

- ① **CN01-DISPLAY**
- #1: DC12V
 - #2: LED_Operation
 - #3: LED_Defrost
 - #4: LED_Timer
 - #5: -
 - #6: LED_Filter
 - #7: -
 - #8: Remocon Signal Out
 - #9 : Panel Select
 - #10: Remocon Signal In
 - #11: GND
 - #12: DC5V
 - #13: -

■ AC071RN4PKG

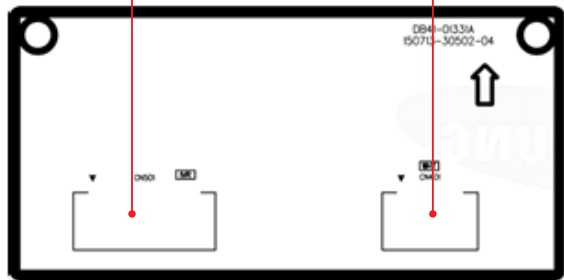
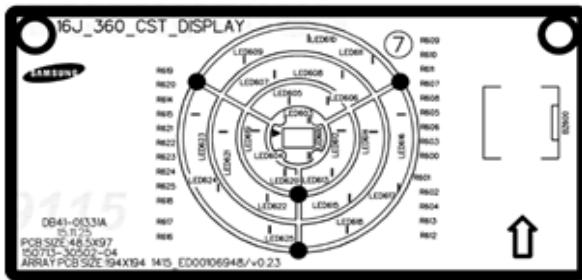

- ① **CN401 – DISPLAY1**
- #1 : 12V
 - #2 : VISUALIZATION LED_SECTION2, LAYER2
 - #3 : VISUALIZATION LED_SECTION2, LAYER3
 - #4 : VISUALIZATION LED_SECTION3, LAYER1
 - #5 : VISUALIZATION LED_SECTION3, LAYER2
 - #6 : VISUALIZATION LED_SECTION3, LAYER3

- ② **CN501 – DISPLAY2**
- #1 : BUZZER1
 - #2 : BUZZER2
 - #3 : CENTER 3 COLOR LED - BLUE
 - #4 : CENTER 3 COLOR LED - GREEN
 - #5 : CENTER 3 COLOR LED - RED
 - #6 : CENTER LED – ICE BLUE
 - #7 : VISUALIZATION LED_SECTION1, LAYER1
 - #8 : VISUALIZATION LED_SECTION1, LAYER2
 - #9 : VISUALIZATION LED_SECTION1, LAYER3
 - #10 : VISUALIZATION LED_SECTION2, LAYER1

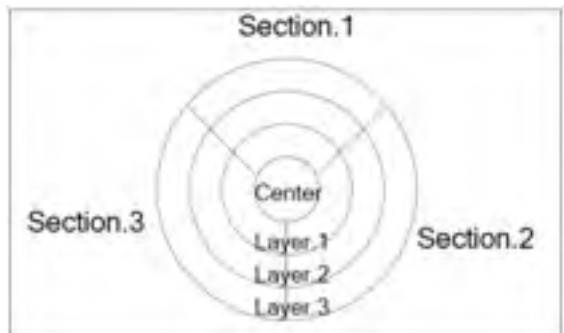

This Document can not be used without Samsung's authorization.

5-1-3 Sub PCB

■ AC026/035/052/071RNADKG

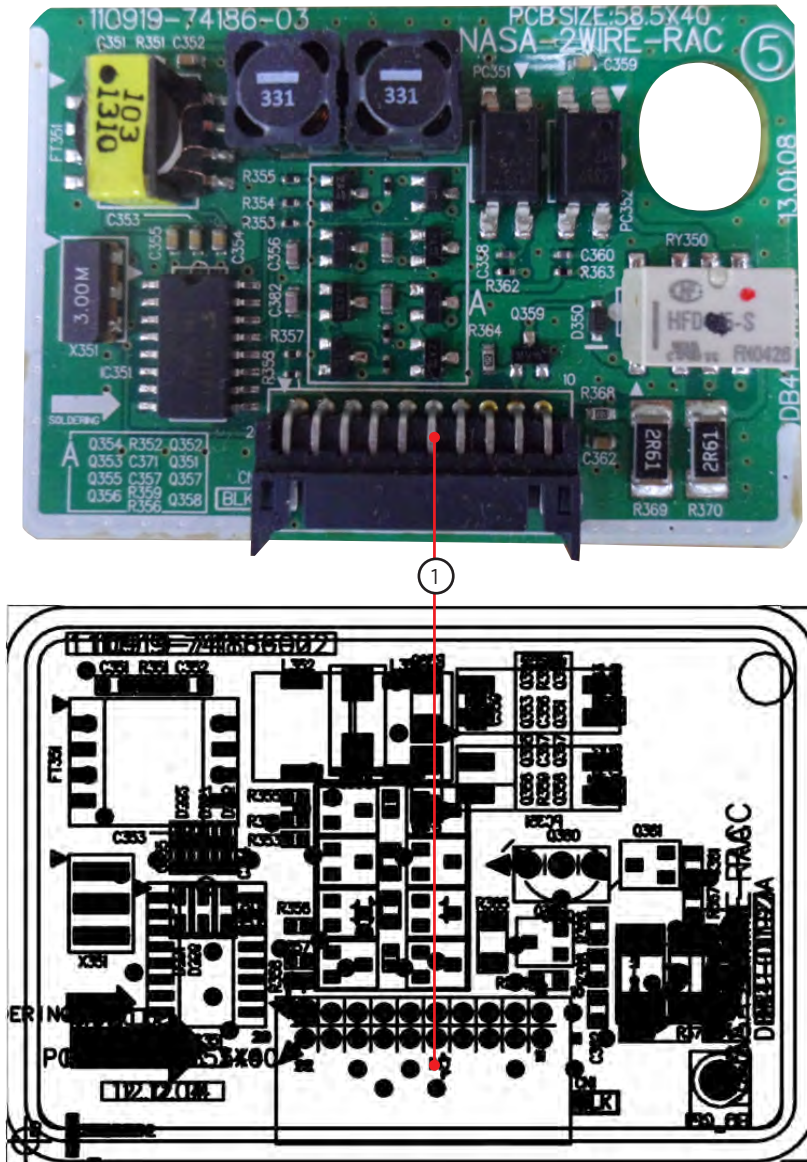

- ① CN1-2WIRES COMM.
 - #1,#2,#19,#20:COMM. SIGNAL
 - #3,#18:EXTERNAL CONTROL
 - #4,#17:COMP CHECK
 - #5,#16:ERROR CHECK
 - #6:VCC(DC5V)
 - #7,#14:GND
 - #8,#13,#15:DC12V
 - #9~#12:COMM. SIGNAL

This Document can not be used without Samsung's authorization.

5-1-4 BLDC PBA

■ AC035/052/071RNMDKG

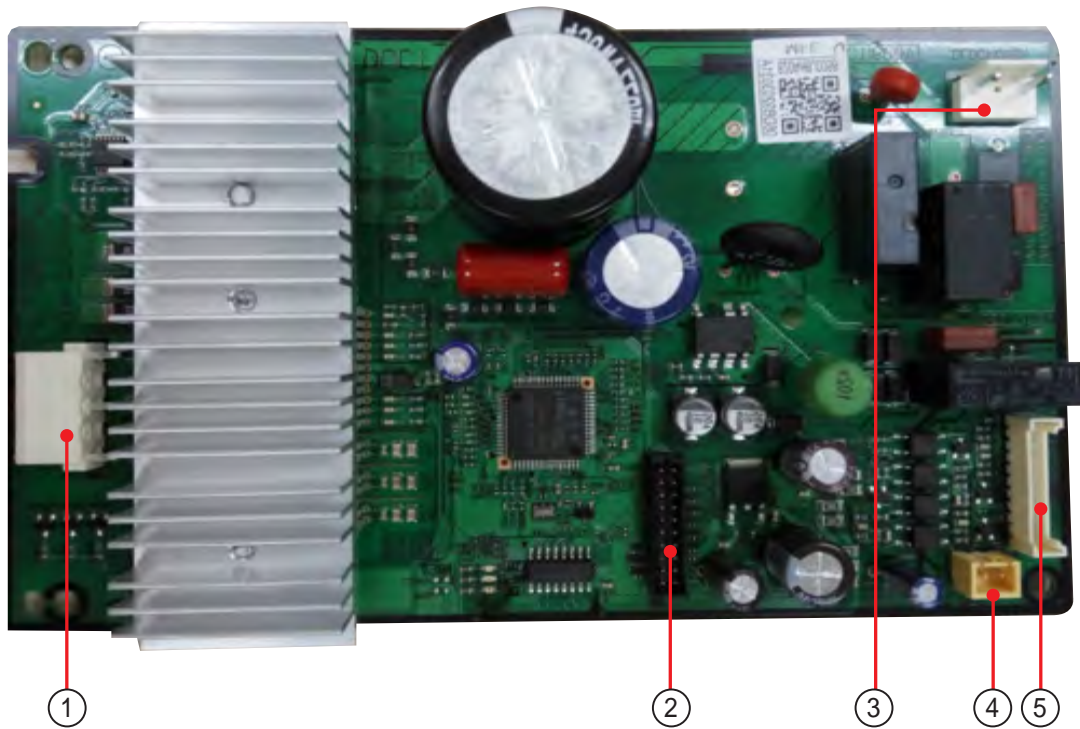

<p>① CN301 : FAN MOTOR #1 : MOTOR-U PHASE #2 : NOT USED #3 : MOTOR-V PHASE #4 : NOT USED #5 : MOTOR-W PHASE</p>	<p>② CN461 : SW DOWNLOAD -</p>	<p>③ CN701 : POWER #1 : N #2 : NOT USED #3 : L</p>	<p>④ CN502 : UART COMM. #1 : MAIN_RXD_INV_TXD #2 : MAIN_TXD_INV_RXD</p>
<p>⑤ CN501 : TO MAIN SIGNAL #1 : DC12V #2 : GND #3 : DC5V #4 : BLDC POWER RELAY #5 : NOT USED #6 : NOT USED #7 : GND #8 : FAN FEEDBACK #9 : NOT USED #10 : FAN RPM</p>			

This Document can not be used without Samsung's authorization.

5-2 Outdoor Unit

5-2-1 MAIN PCB

■ AC026/035/052/071RXADKG/EU

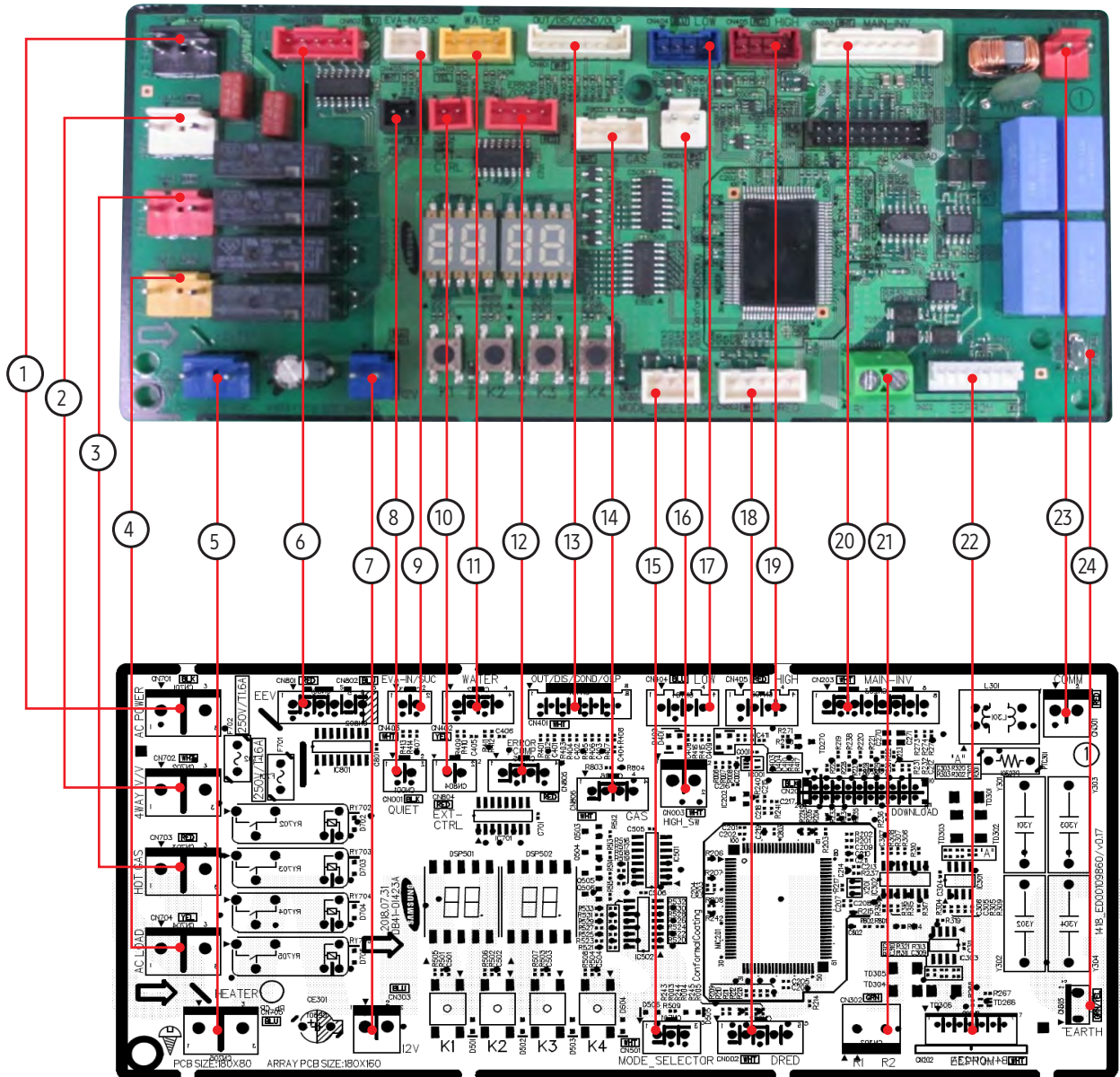

This Document can not be used without Samsung's authorization.

① CN701-AC POWER #1: L #2: - #3: N	② CN702-4WAY #1: N #2: - #3: L / RELAY CONTACT	③ CN703-HOT GAS (AC LOAD) #1: N #2: - #3: L / RELAY CONTACT	④ CN704-AC LOAD (AC LOAD) #1: N #2: - #3: L / RELAY CONTACT
⑤ CN705-BASE HEATER (AC LOAD) #1: N #2: - #3: L / RELAY CONTACT	⑥ CN801/CN802-EEV CAM/EDM #1: EEV A #2: EEV B #3: EEV A BAR #4: EEV B BAR #5, 6: 12V	⑦ CN303-DC 12V #1: DC12V #2: GND	⑧ CN001-QUIET #1: DC5V #2: GND
⑨ CN403-EVA IN SUCTION #1: SUCTION SENSOR #2: GND	⑩ CN804-EXTERNAL #1: DC 12V #2: GND	⑪ CN402-WATER IN, OUT SENSOR #1: WATER IN SENSOR #3: WATER OUT SENSOR #2,4: GND	⑫ CN805-COMP, ERROR CHECK #1, 3: DC 12V #2: ERROR CHECK #2: COMP CHECK
⑬ CN401- THERMISTOR #1: OUTDOOR SENSOR #3: DISCHARGE SENSOR #5: COND SENSOR #7: EEV B BAR #2, 4, 6, 8: GND	⑭ CN806-GAS SENSOR #1: DC5V #2: GND #3: - #4: GAS SENSOR	⑮ CN501-MODE SELETOR #1, 3: GRID_1 #2: GRID_2	⑯ CN003-HIGH PRESSURE SWITH #1: DC5V #3: GND
⑰ CN404-LOW PRESSURE SENSOR #1: - #2: LOW PRESSURE SENSOR #3: GND #4: DC5V	⑱ CN405-HIGH PRESSURE SENSOR #1: - #2: HIGH PRESSURE SENSOR #3: GND #4: DC5V	⑲ CN002-DRED #1~3: DRED 1, 2, 3 #4: GND #5: DC5V	⑳ CN203-MAIN-INV COMM #1: TXD #2: RXD #3: DC5V #4: GND #5: DC12V #6: POWER CTRL #7: AC ON #8: AC LOAD2
㉑ CM302-SOLUTION #1: R1+ #2: R2-	㉒ CN202-EEPROM #1~7: EEPROM	㉓ CM301-INDOOR-OUTDOOR COMM #1: F1 #2: F2	㉔ CN305-EARTH #1: EARTH

5-2-2 INVERTER PCB

■ AC026/035RXADKG/EU

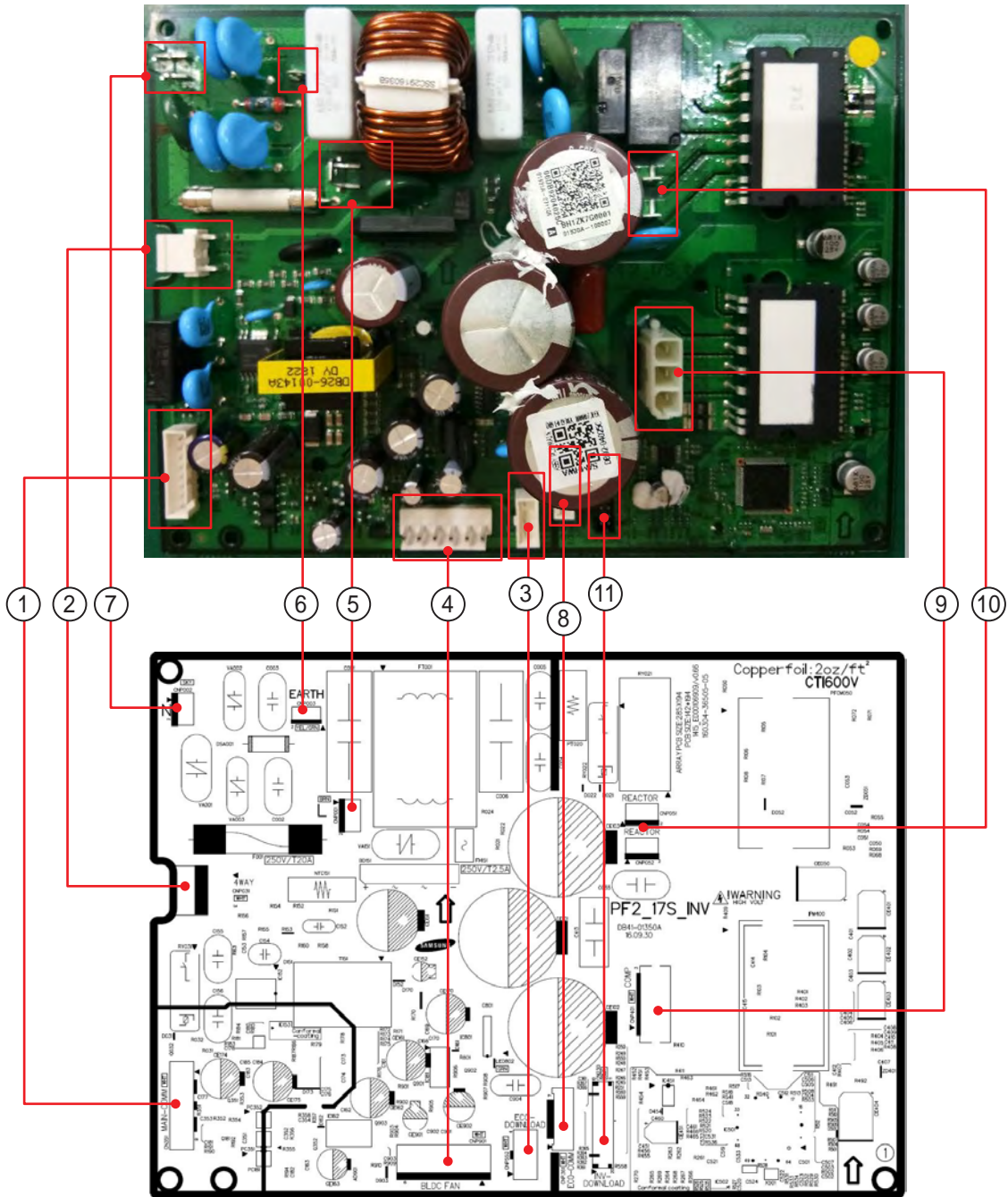

This Document can not be used without Samsung's authorization.

① CN351 - MAIN INV. COMM #1 : RXD #2 : TXD #3 : DC5V #4 : GND #5 : DC12V #6 : POWER CTRL #7 : 4WAY(AC LOAD) #8 : -	② CNP031 – MAIN POWER #1 : N #2 : - #3 : L	③ CNP552 – ECO DOWNLOAD #1 : RXD_INV #2 : TXD_INV #3 : GND #4 : DC5V	④ CNP901 #1 : DC310V #2 : - #3 : GND #4 : DC15V #5 : V_sp #6 : F/B
⑤ CNP001 – L / TAP TERMINAL #1 : L	⑥ CNP003 – EARTH / TAP TERMINAL #1 : EARTH	⑦ CNP002 – N / TAP TERMINAL #1 : N	⑧ CNP361 – ECO DOWNLOAD #1~#7 : ECO COMM PART
⑨ CNP401 – COMP #1 : W Phase #2 : V Phase #3 : U Phase	⑩ CNP051,CNP052 – REACTOR #1 : REACTOR	⑪ DOWNLOAD #1~#20 : DOWNLOAD	

■ AC052/071RXADKG/EU

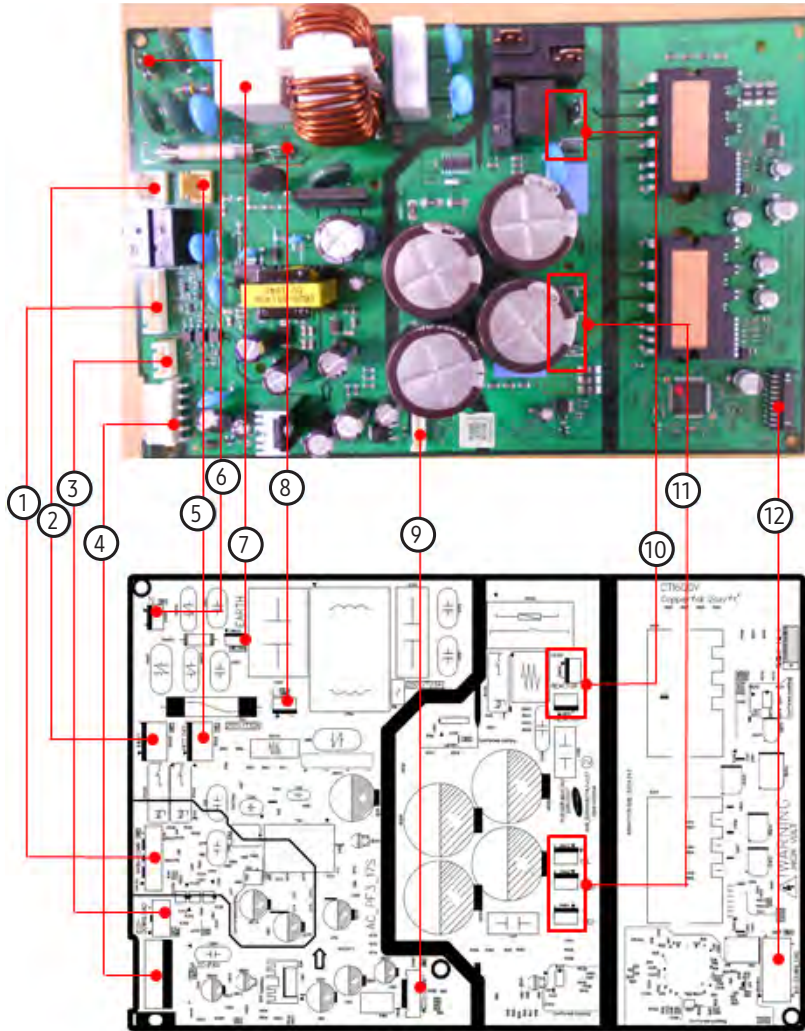

<p>① CNP351-MAIN INV #1: RXD #2: TXD #3: DC5V #4: GND #5: DC12V #6: POWER CTRL #7: AC LOAD #8: AC LOAD2</p>	<p>② CN030-MAIN POWER #1: N #2: - #3: L</p>	<p>③ CN571-ECO DOWNLOAD #1~4: ECO DOWNLOAD</p>	<p>④ CNP901- BLDC FAN #1: DC310V #2: - #3: PGND #4: DC15V #5: V_SP #6: F/B</p>
<p>⑤ CN241-HOT GAS (AC LOAD) #1: L / RELAY CONTACT #2: - #3: N</p>	<p>⑥ CN001-N / TAP TERMINAL #1: N</p>	<p>⑦ CN571-EARTH TAP TERMINAL #1: EARTH</p>	<p>⑧ CN002-L / TAP TERMINAL #1: L</p>
<p>⑨ CN581-ECO COMM #1~7: ECO COMM port</p>	<p>⑩ CN401, 402, 403-COMP #CN401: U, RED #CN402: V, BLU #CN403: W, YEL</p>	<p>⑪ CN051, 052-REACTOR #CN501,052: REACTOR</p>	<p>⑫ CN551-DOWNLOAD #1~20: DOWNLOAD</p>

This Document can not be used without Samsung's authorization.

6. Wiring Diagram

6-1 Indoor Unit

■ AC026/035RN1DKG

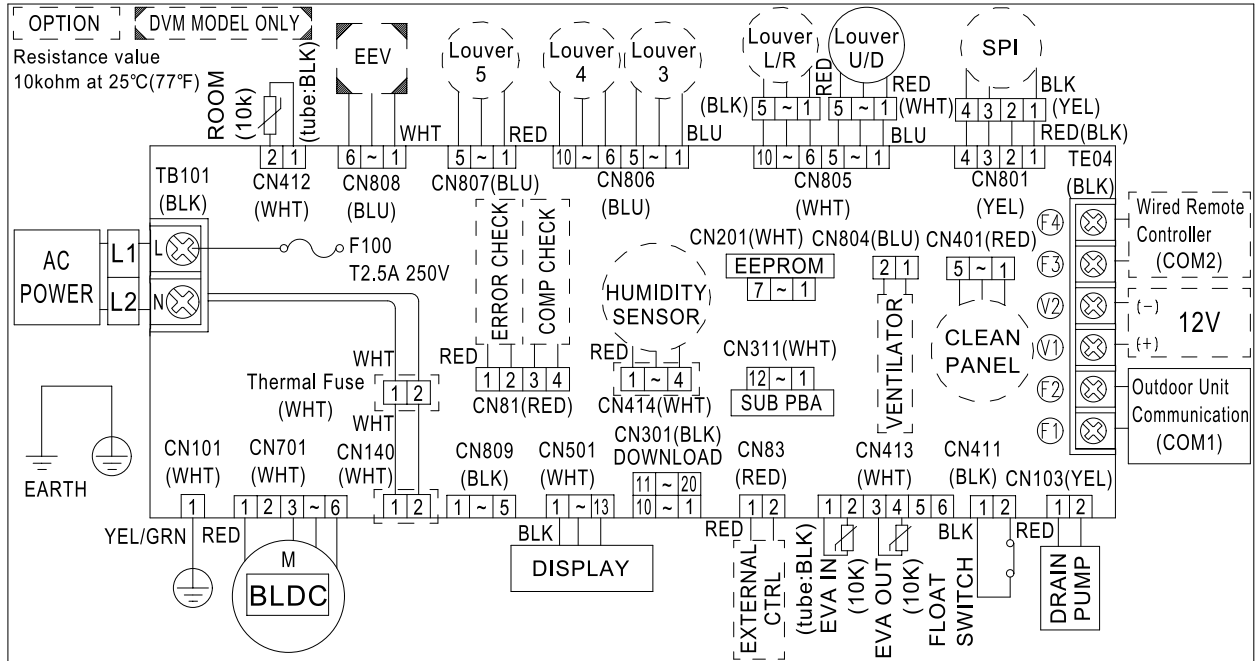

USE COPPER SUPPLY WIRES. UTILISER DES FILS D'ALIMENTATION EN CUIVRE.

LED LAMP DISPLAY				LED DISPLAY FOR ERROR DETECTION
OPERATION	TIMER	FAN	FILTER	
●	○	○	○	● ON ○ FLICKERING × OFF
×	●	×	×	Error of room temperature sensor in the indoor unit(open/short)
●	●	×	×	Error of eva in,out temperature sensor in the indoor unit(open/short)
×	×	●	×	Error of fan motor in the indoor unit
●	×	●	×	Error of outdoor sensor(Outdoor temperature/cond/discharge)
×	●	●	×	No communication for 2 minutes between indoor and outdoor unit
×	●	●	●	Error of outdoor unit/Self-diagnosis(Check error code at outdoor unit's or solution display)
×	×	●	●	Detection of the float switch
●	●	●	●	EEPROM error/EEPROM option error
×	×	×	●	No match between outdoor and indoor unit

Indoor Unit (cont.)

■ AC052/071RN4DKG

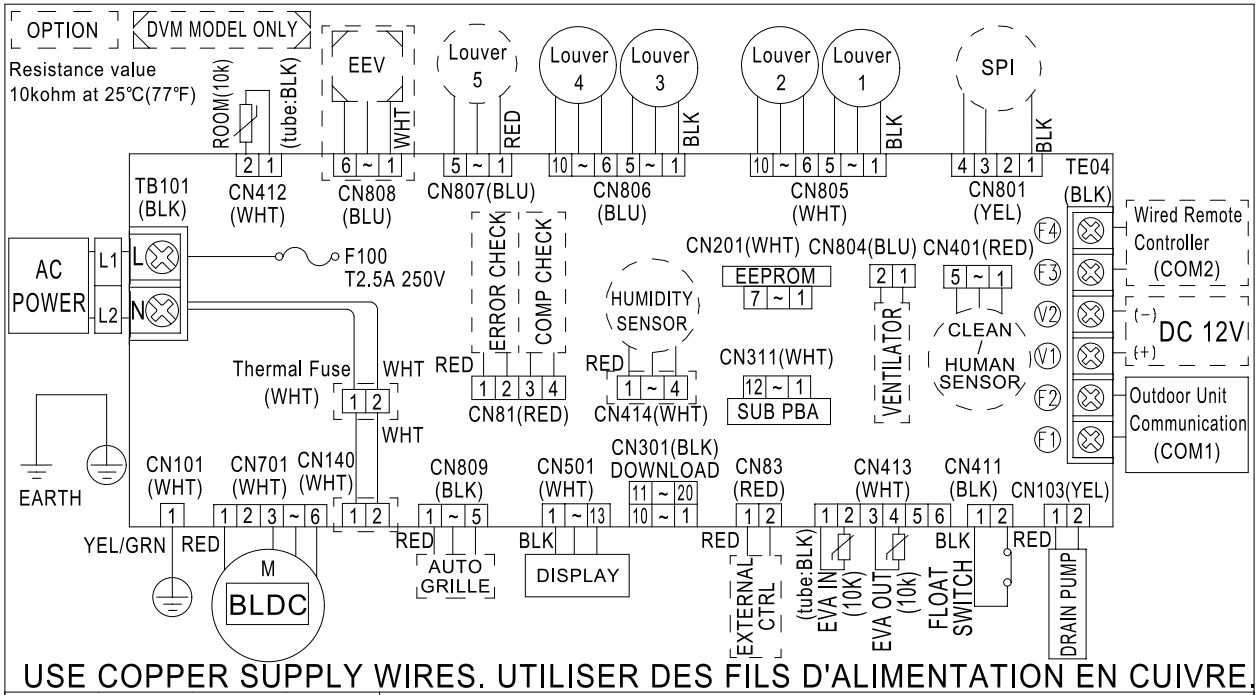

USE COPPER SUPPLY WIRES. UTILISER DES FILS D'ALIMENTATION EN CUIVRE.

LED LAMP DISPLAY				LED DISPLAY FOR ERROR DETECTION
OPERATION	DEFROST	TIMER	FILTER	
●	●	●	●	● ON ○ FLICKERING × OFF
×	●	×	×	Error of room temperature sensor in the indoor unit(open/short)
○	○	×	×	Error of eva in,out temperature sensor in the indoor unit(open/short)
×	×	○	×	Error of fan motor in the indoor unit
○	×	○	×	Error of outdoor sensor(Outdoor temperature/cond/discharge)
×	○	○	×	No communication for 2 minutes between indoor and outdoor unit
×	○	○	○	Error of outdoor unit/Self-diagnosis (Check error code at outdoor unit's or solution display)
×	×	○	○	Detection of the float switch
○	○	○	○	EEPROM error/EEPROM option error
○	×	×	○	MDS (Motion Detecting Sensor) Error
○	○	×	○	No match between outdoor and indoor unit
○	×	○	○	High Pressure Blockage Error (Only CAC Model)

Indoor Unit (cont.)

■ AC071RN4PKG

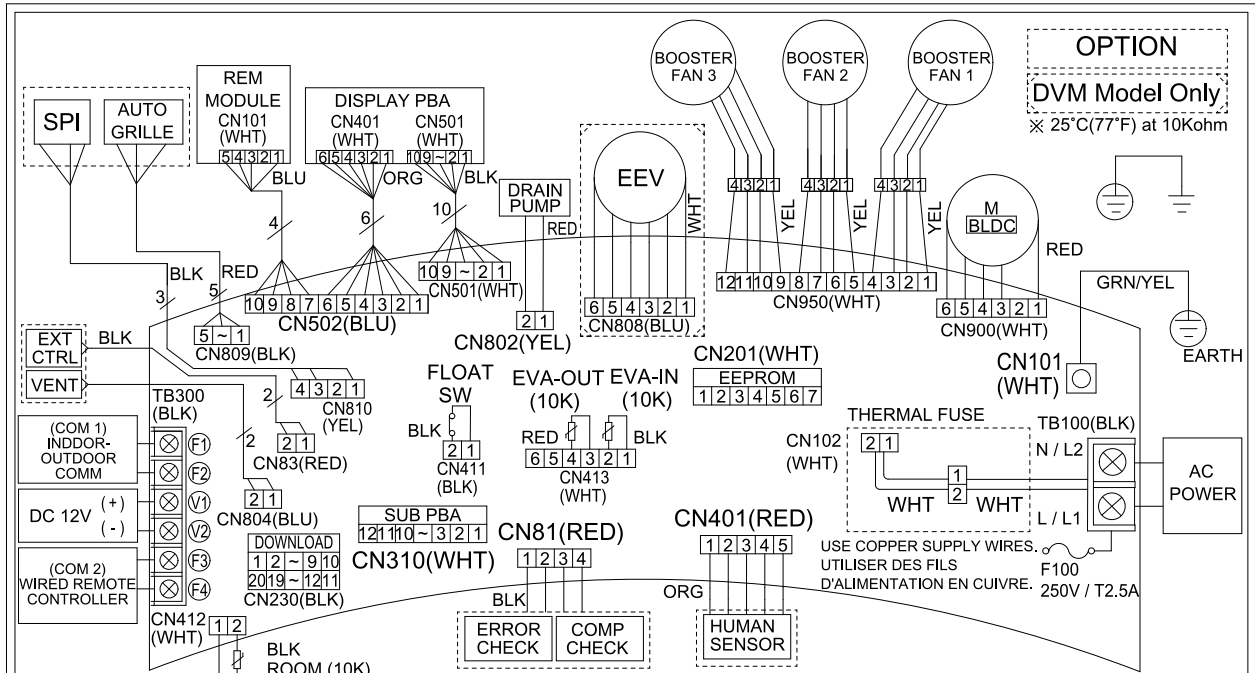

LED LAMP DISPLAY ● On ● Flickering	LED DISPLAY FOR ERROR DETECTION	LED LAMP DISPLAY ● On ● Flickering	LED DISPLAY FOR ERROR DETECTION
● ICE BLUE	Operating	● RED	Smart Install Error (Only CAC Model)
● ICE BLUE	Power Reset (Flickering every 2 seconds)	● RED - GRN Alternation of Flickering	Error of EVA- IN / OUT / DISCHARGE Sensor In the Indoor Unit (Open/short)
● ICE BLUE	Defrosting Operation (Flickering every 10 Seconds)	● RED - BLU Alternation of Flickering	Error of Fan Motor In the Indoor Unit
● BLU	Reserving Mode	● GRN - BLU Alternation of Flickering	Detection of the Float Switch
● GRN	Filter Usage Expiration	● ICE BLU - BLU Alternation of Flickering	Detection of the Thermal Fuse Open
● RED	Error of Room Sensor In the Indoor Unit (Open/short)	● ICE BLU - RED Alternation of Flickering	Miss Matching Of Indoor and Outdoor Unit (Only DVM Model)
● BLU	Error Of Outdoor Unit	● ICE BLU - GRN Alternation of Flickering	Miss Matching Of Indoor and Outdoor Unit (Only DVM Model)
● GRN	No Communication For 2 Minutes Between Indoor and Outdoor Unit	● RED - ICE BLU - GRN Alternation of Flickering	Error of EEPROM
● RED-ICE BLU-GRN Alternation of Flickering	Error of Motion Detecting Sensor		

This Document can not be used without Samsung's authorization.

Indoor Unit (cont.)

■ AC026/035/052/071RNADKG

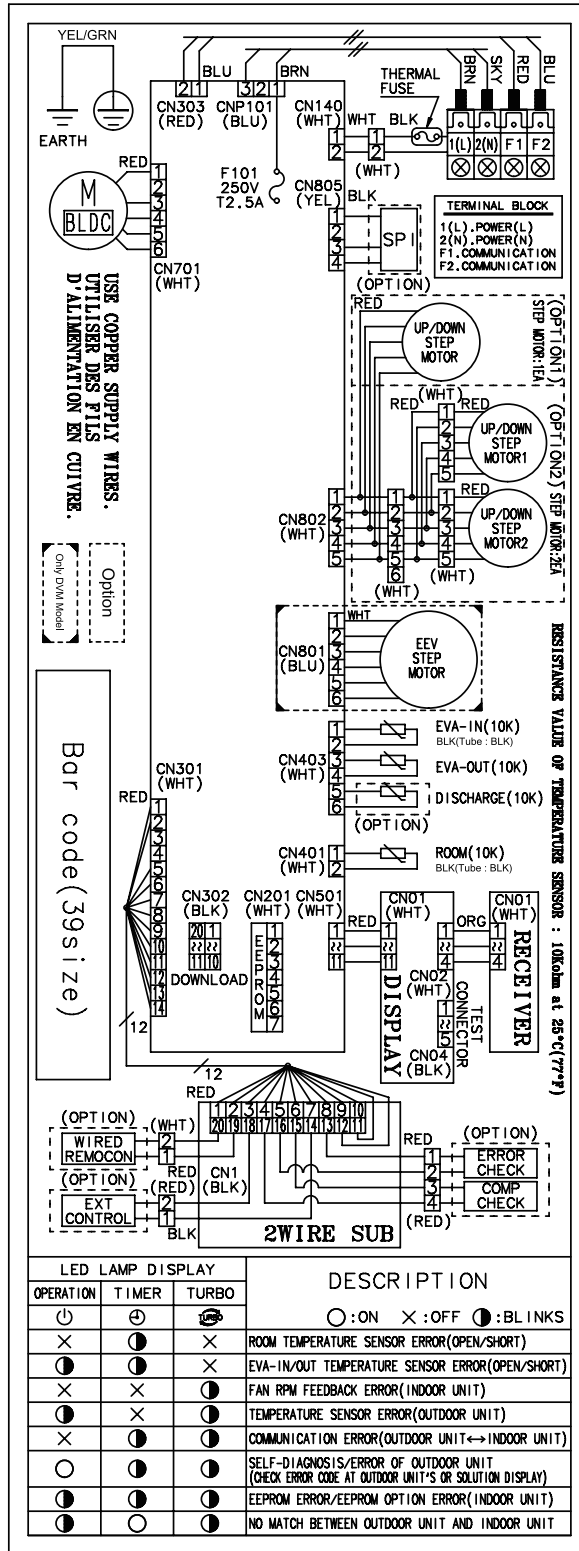

This Document can not be used without Samsung's authorization.

Indoor Unit (cont.)

■ AC026/035/052/071RNLDKG

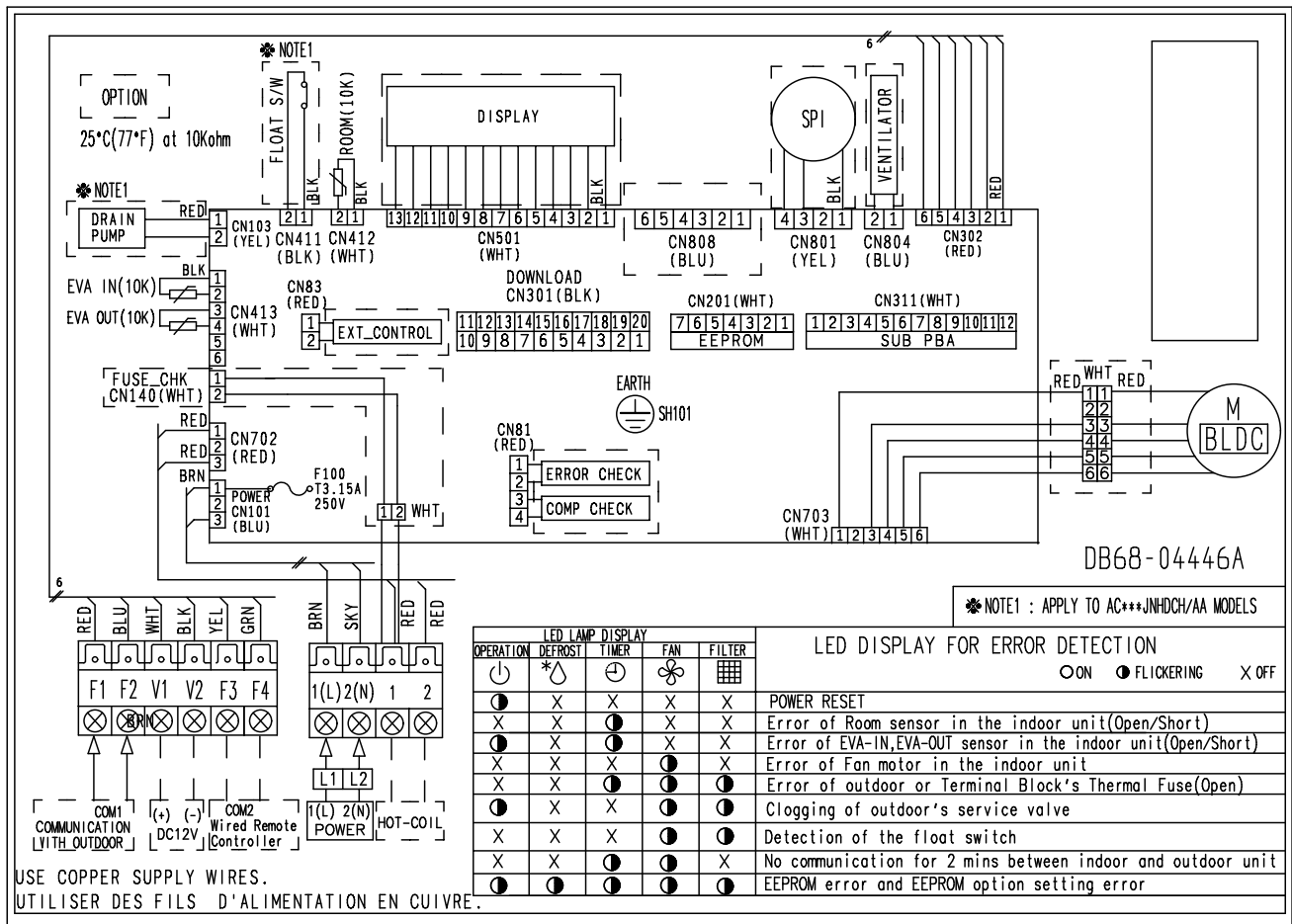

This Document can not be used without Samsung's authorization.

Indoor Unit (cont.)

■ AC035/052/071RNMDKG

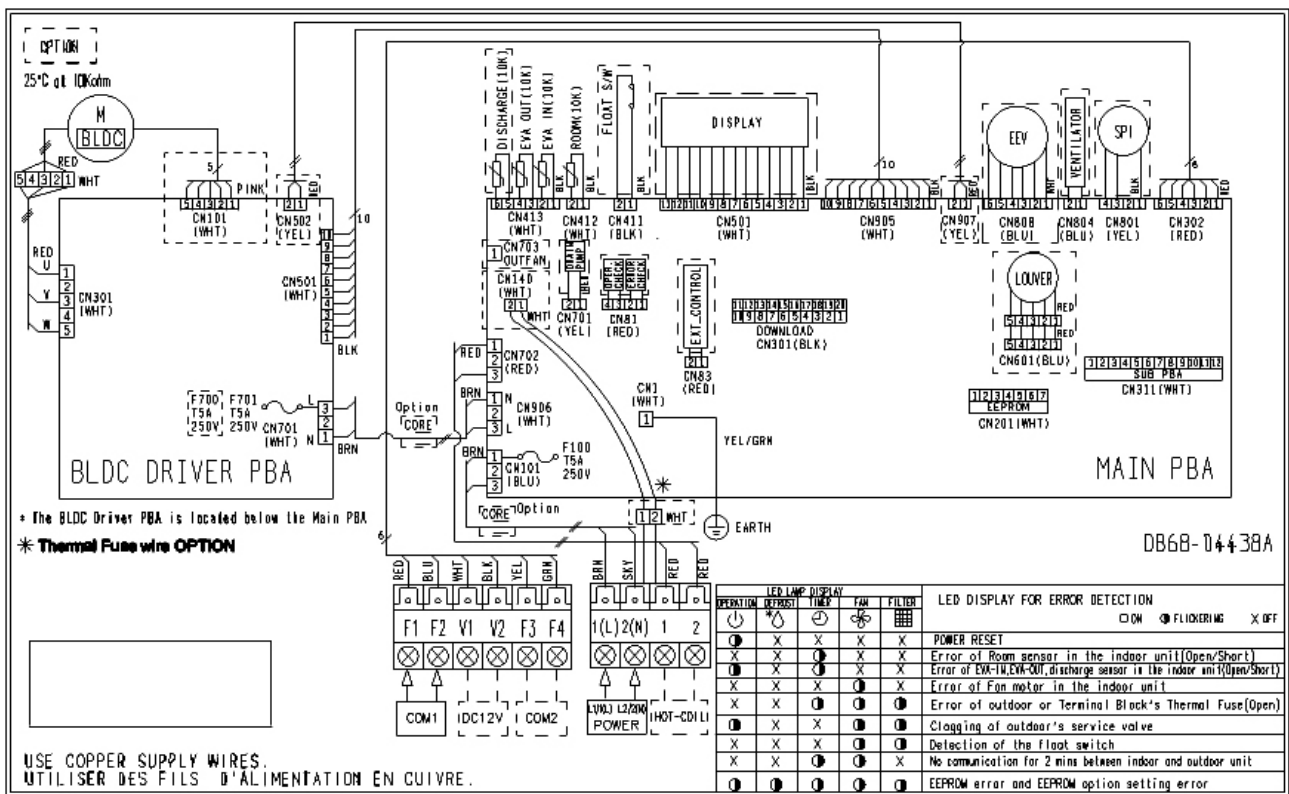

Indoor Unit (cont.)

■ AC026/035/052/071RNNDKG

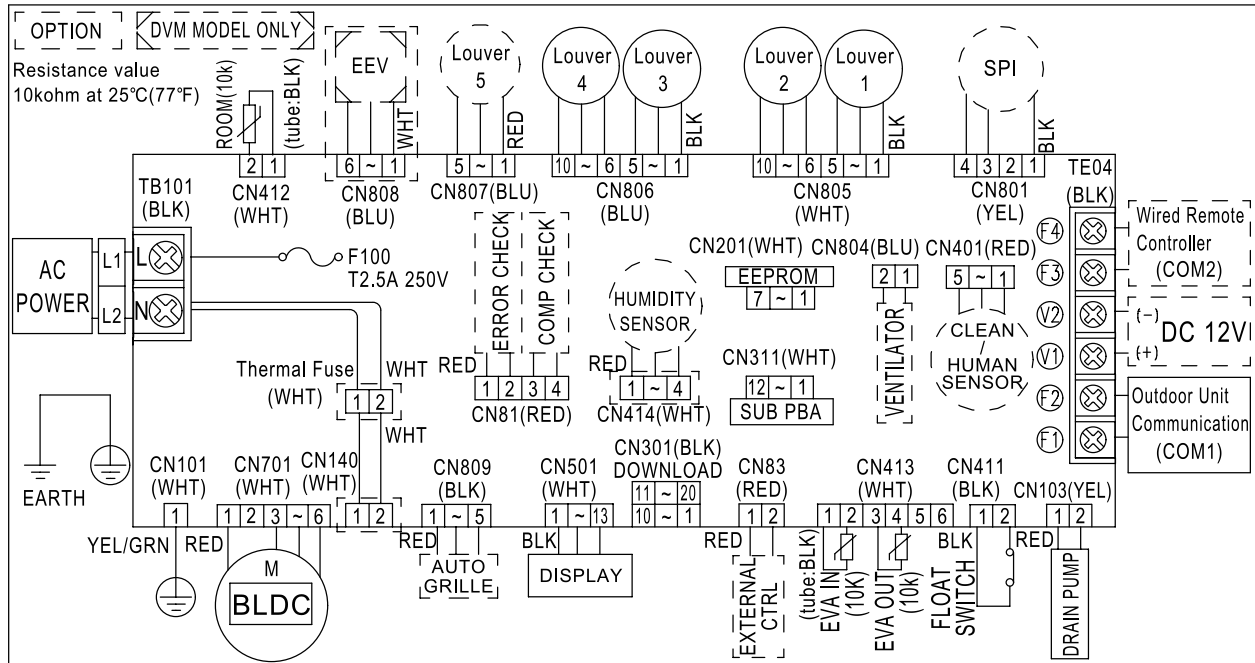

USE COPPER SUPPLY WIRES. UTILISER DES FILS D'ALIMENTATION EN CUIVRE.

LED LAMP DISPLAY				LED DISPLAY FOR ERROR DETECTION
OPERATION	DEFROST	TIMER	FILTER	
				● ON ○ FLICKERING × OFF
×	○	×	×	Error of room temperature sensor in the indoor unit(open/short)
○	○	×	×	Error of eva in,out temperature sensor in the indoor unit(open/short)
×	×	○	×	Error of fan motor in the indoor unit
○	×	○	×	Error of outdoor sensor(Outdoor temperature/cond/discharge)
×	○	○	×	No communication for 2 minutes between indoor and outdoor unit
×	○	○	○	Error of outdoor unit/Self-diagnosis (Check error code at outdoor unit's or solution display)
×	×	○	○	Detection of the float switch
○	○	○	○	EEPROM error/EEPROM option error
○	×	×	○	MDS (Motion Detecting Sensor) Error
○	○	×	○	No match between outdoor and indoor unit
○	×	○	○	High Pressure Blockage Error (Only CAC Model)

This Document can not be used without Samsung's authorization.

Indoor Unit (cont.)

■ AC052/071RNCDKG

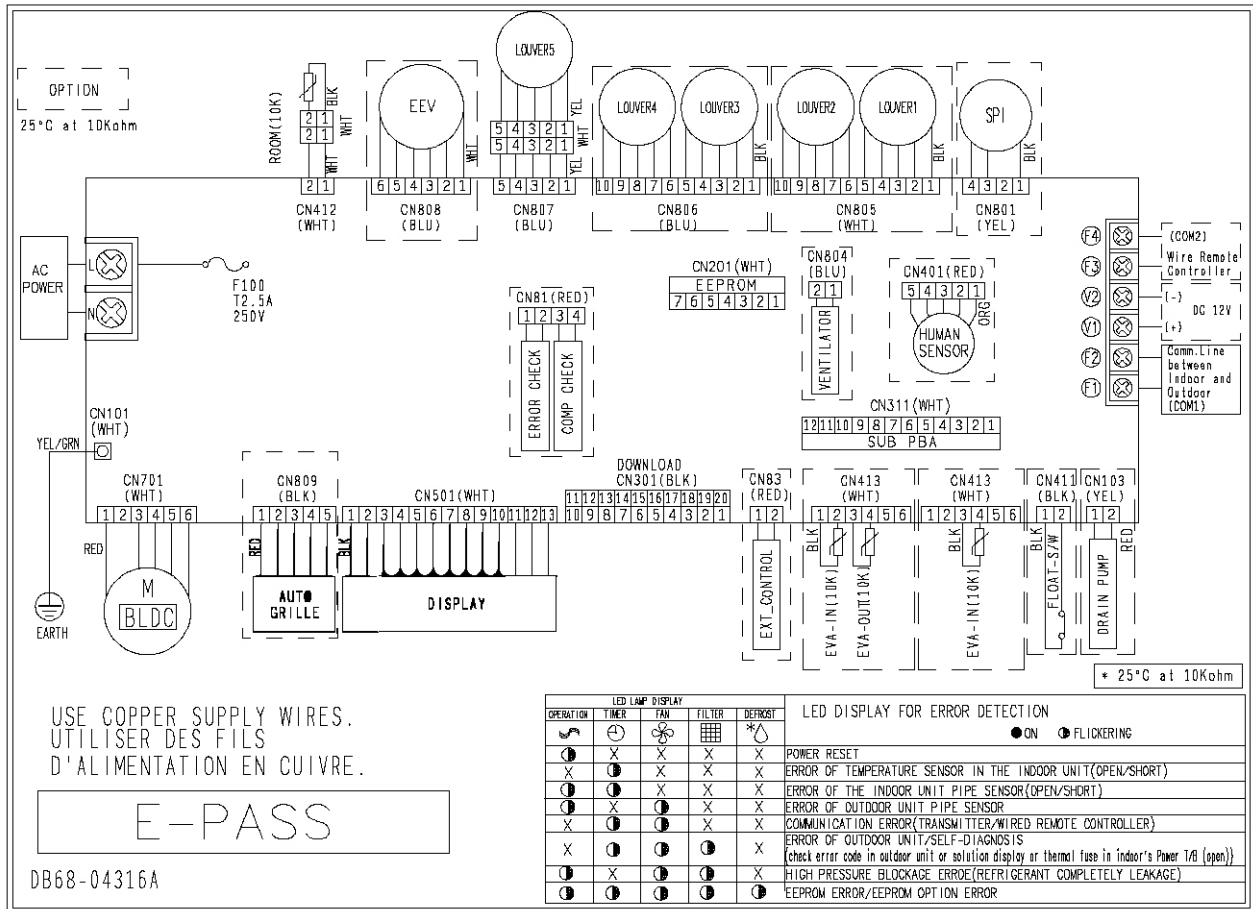

6-2 Outdoor unit

AC026/035RXADKG

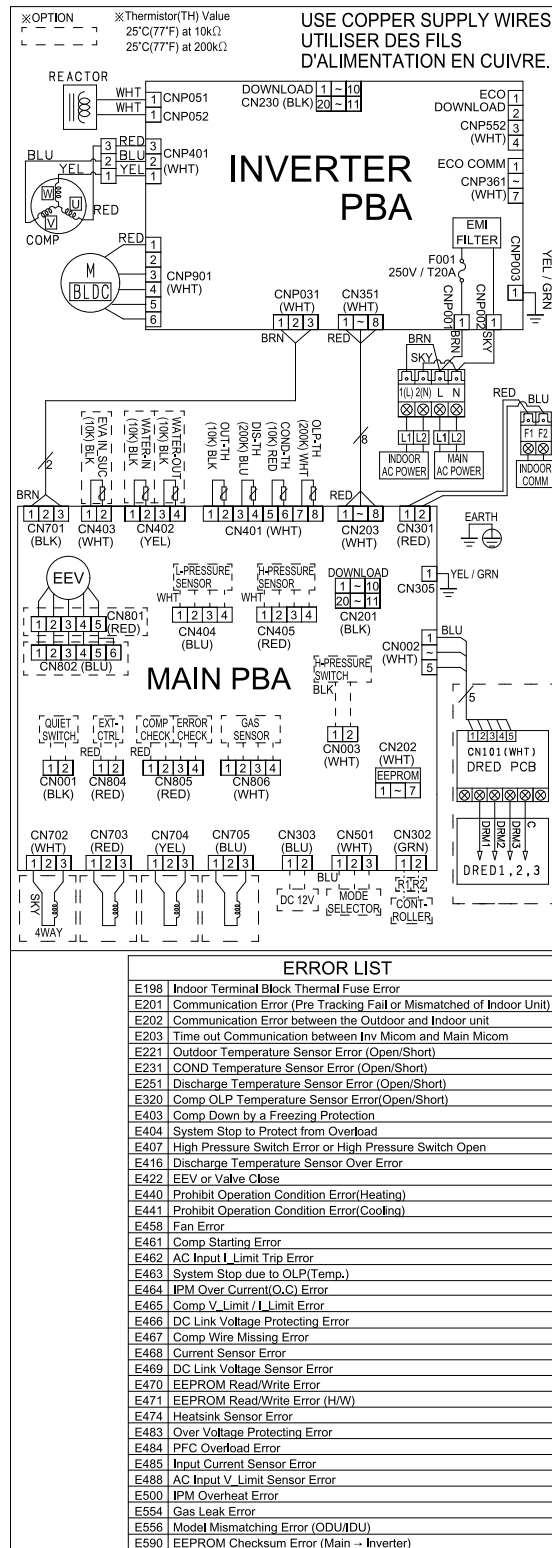

This Document can not be used without Samsung's authorization.

Outdoor unit (cont.)

AC052/071RXADKG

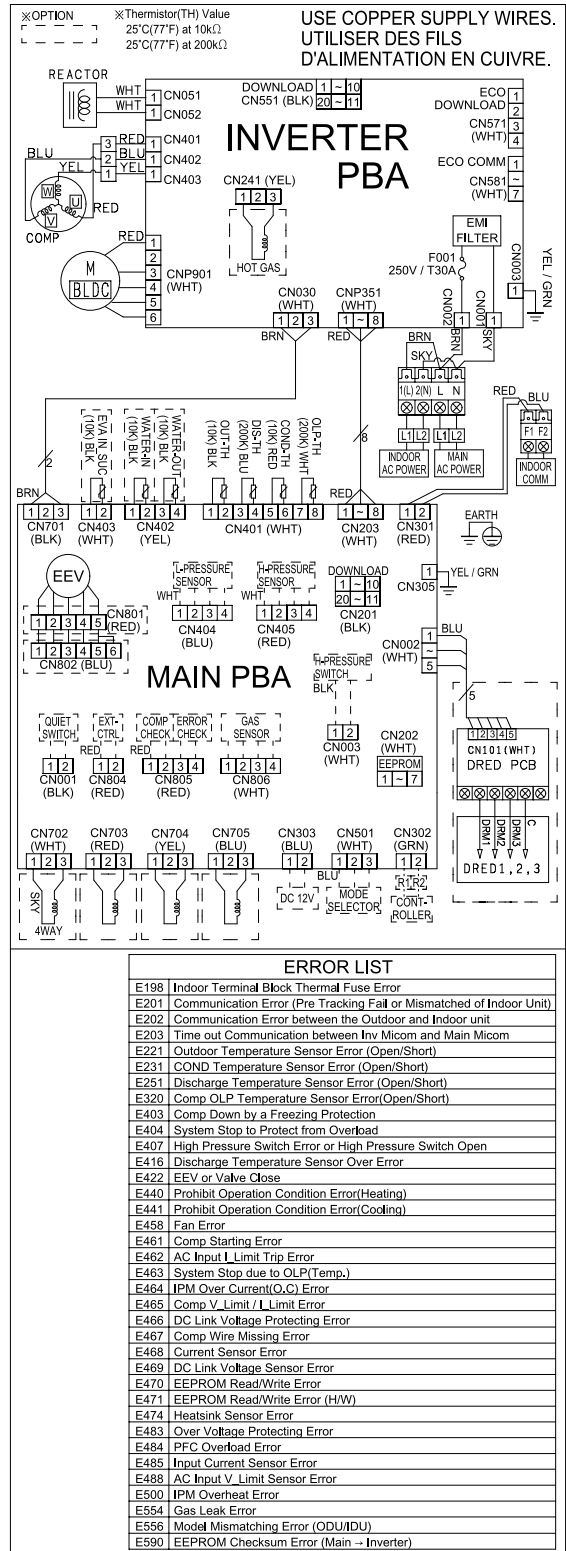

This Document can not be used without Samsung's authorization.

7. Reference Sheet

7-1 Index for Model Name

7-1-1 Indoor Unit

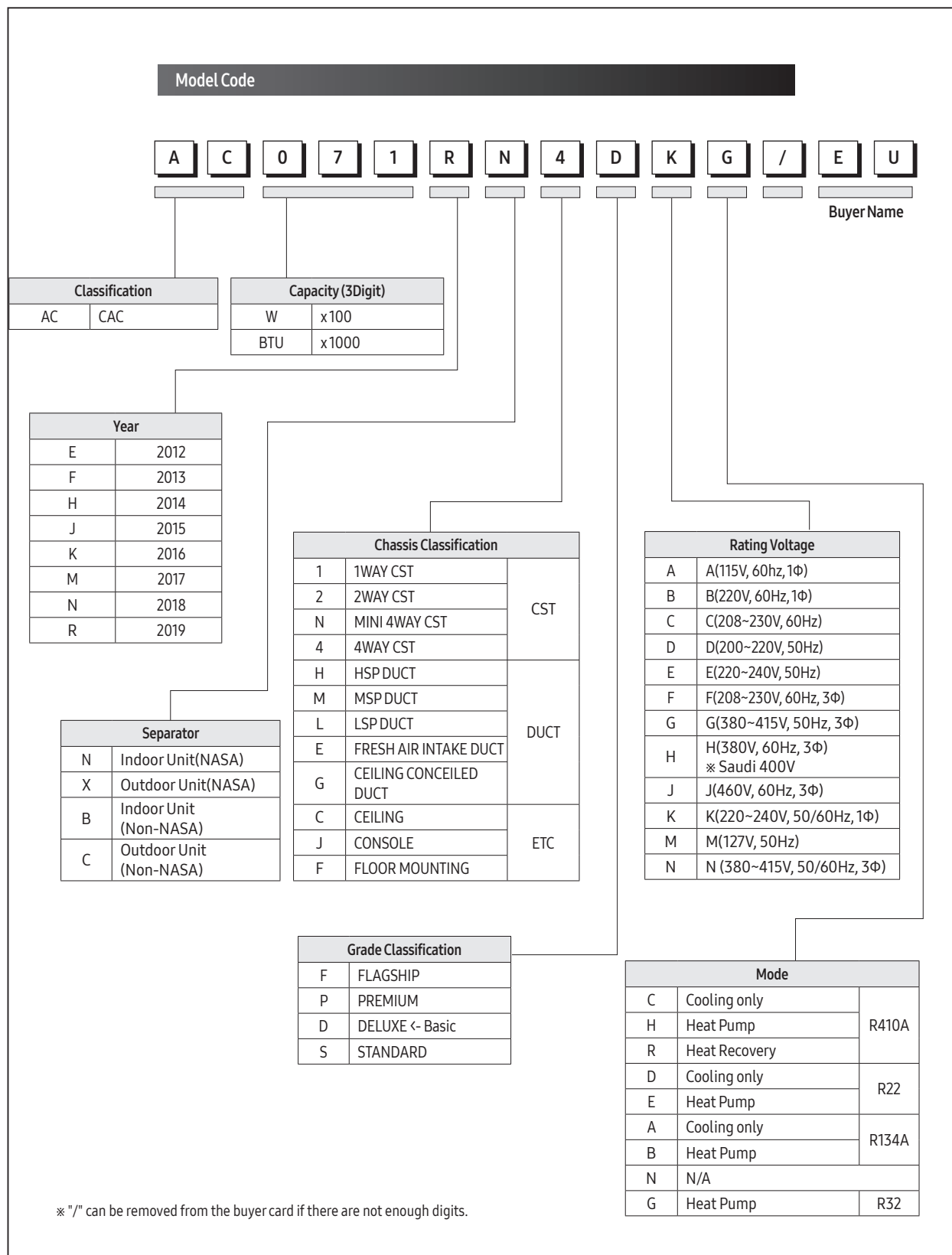

Index for Model Name (cont.)

7-1-2 Outdoor Unit

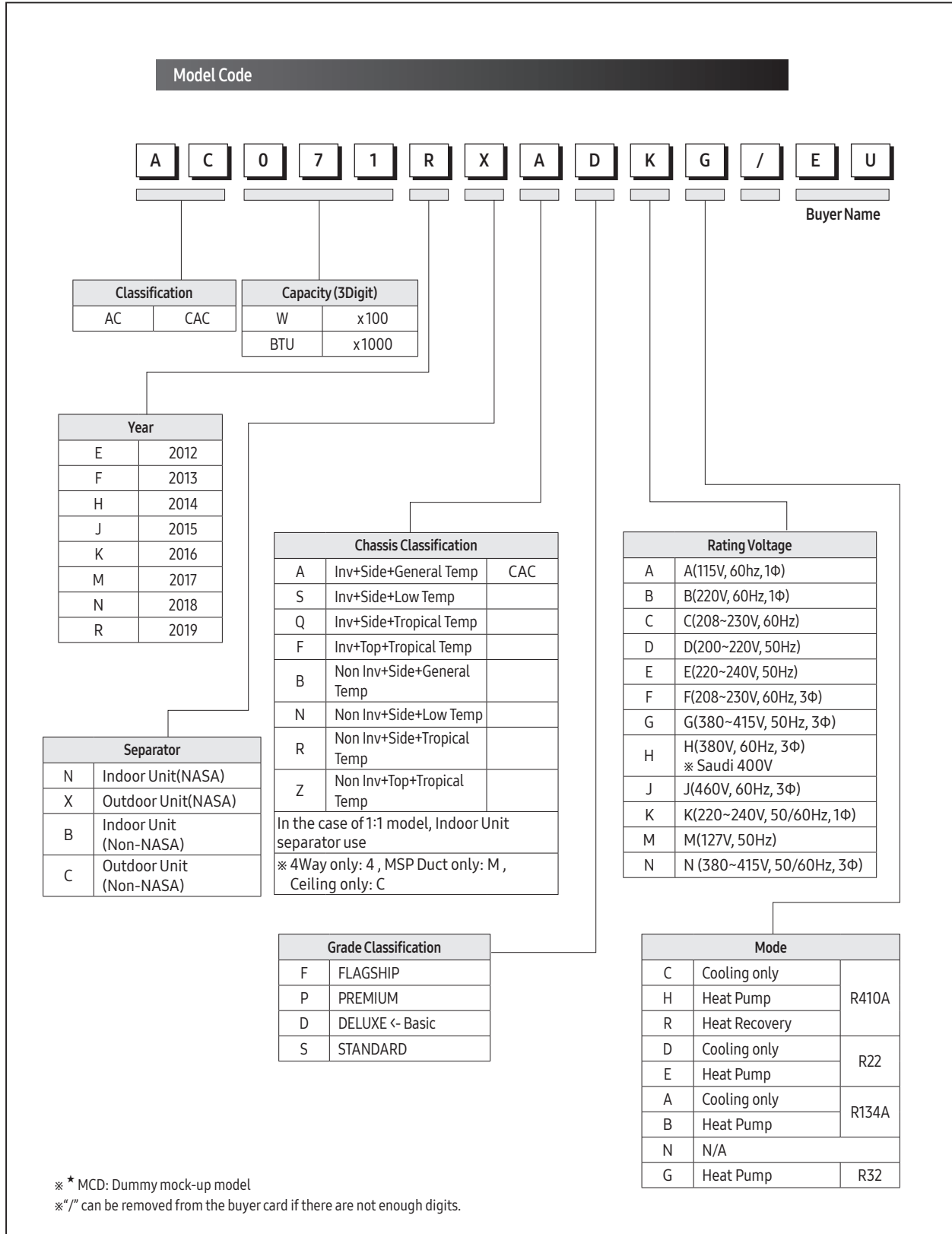

Index for Model Name (cont.)

7-1-3 Panel

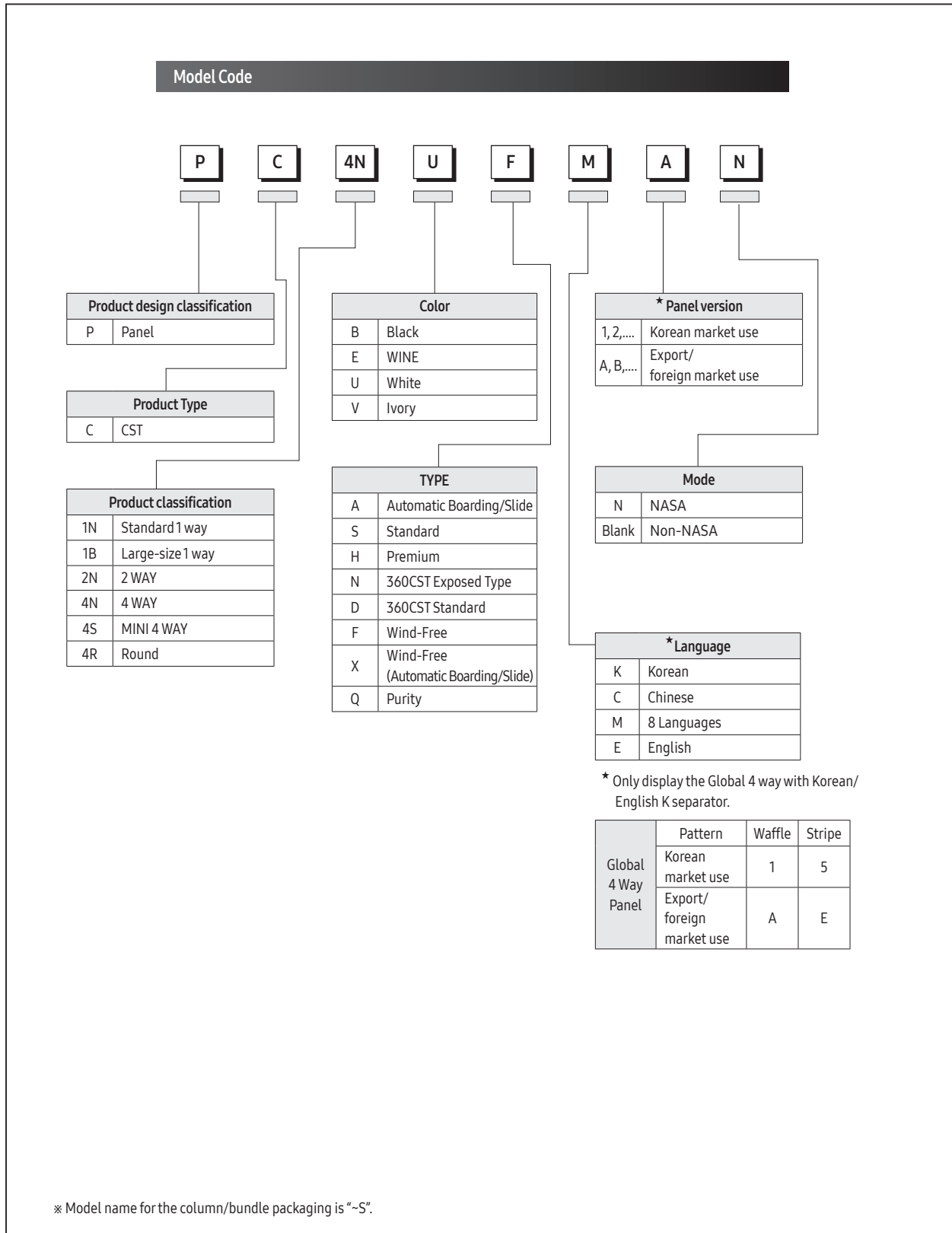

7-2 Refrigerating Cycle Diagram

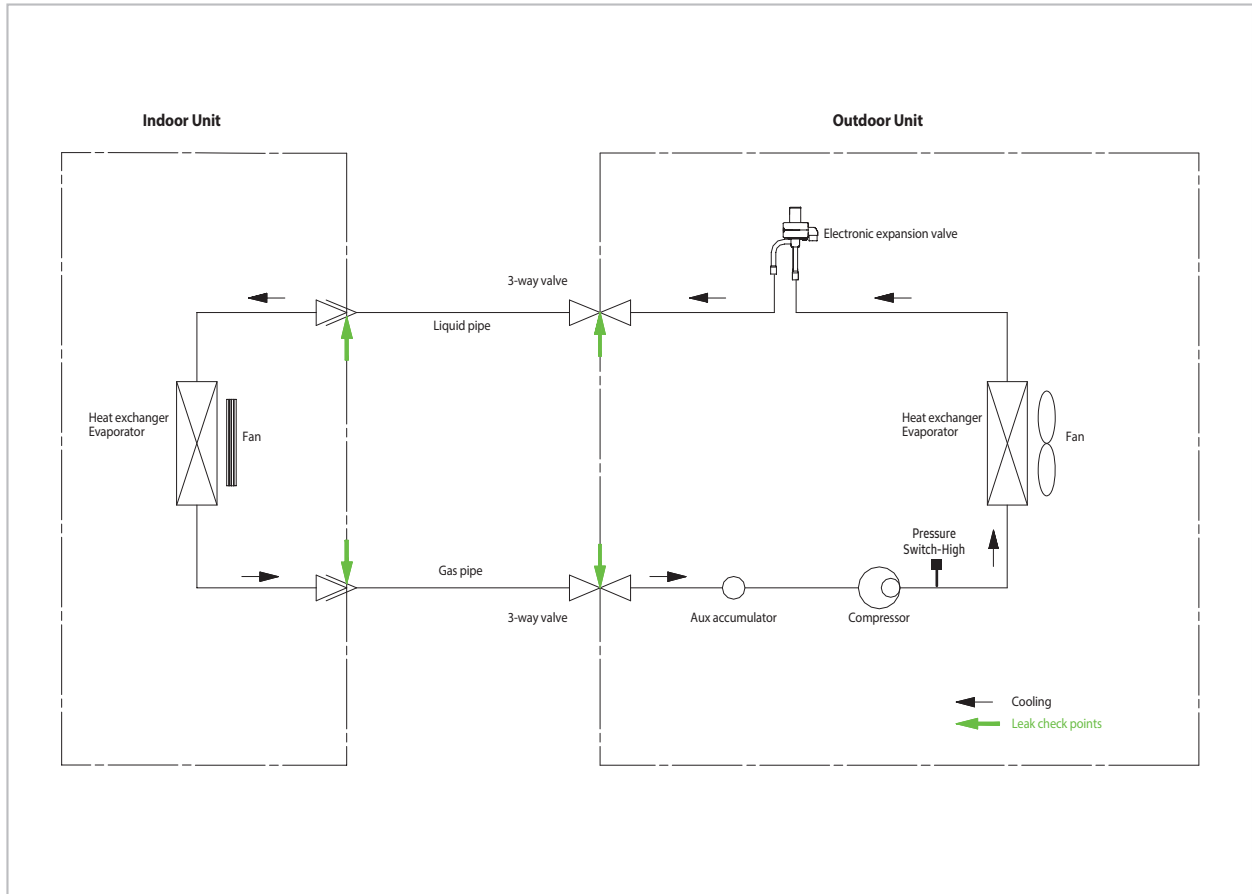

■ CONDENSER

High temperature and high pressure gas state refrigerant discharged from the compressor is converted to a liquid state as it is cooled down by the heat emission in the outdoor condenser unit, and sent to the evaporator.

■ COMPRESSOR

Low temperature and low pressure refrigerant is compressed and sent to the cycling system

■ EVAPORATOR

Liquid refrigerant sucked in through the capillary tubes cools down the room by absorbing the surrounding heat as it evaporates (converting from liquid to gas). (Absorbing heat required for evaporation)

■ SERVICE VALVE

You can open the valve by turning the need valve counterclockwise using hex wrench, and it is used for vacuum, gas purging, refrigerant injection, refrigerant purging, and indoor-outdoor unit connection.

■ ACCUMULATOR

Accumulator prevents the flow of liquid-state refrigerant into the compressor. (Liquid-state refrigerant flowing into the compressor will overload the compressor.)



GSPN (GLOBAL SERVICE PARTNER NETWORK)

Area	Web Site
Europe, CIS, Mideast & Africa	gspn1.samsungcsportal.com
Asia	gspn2.samsungcsportal.com
North & Latin America	gspn3.samsungcsportal.com
China	china.samsungportal.com

This Service Manual is a property of Samsung Electronics Co., Ltd.
Any unauthorized use of Manual can be punished under applicable
International and/or domestic law.

© Samsung Electronics Co., Ltd. January. 2019.
Printed in Korea.
Code No. AC-00232E_1