



4 Way Cassette Type
AC071JN4CEH
AC100JN4CEH
AC125JN4CEH

Air Conditioner installation manual

imagine the possibilities

Thank you for purchasing this Samsung product.

EN DA FI NO SV DE ET DB68-05330A-02

SAMSUNG





Contents

Safety precautions	2
Preparation for installation	4
Deciding on where to install the indoor unit	5
Indoor unit installation	8
Purging the unit	9
Connecting the refrigerant pipe	9
Cutting/Flaring the Pipes	10
Performing leak test & insulation	11
Drainpipe and drain hose installation	12
Connecting the connection cord	15
Setting an indoor unit address and installation option	18
Troubleshooting	25

Safety precautions

Carefully follow the precautions listed below because they are essential to guarantee the safety of the equipment.



WARNING

- Always disconnect the air conditioner from the power supply before servicing it or accessing its internal components.
- Verify that installation and testing operations are performed by qualified personnel.
- Verify that the air conditioner is not installed in an easily accessible area.

General information

- ▶ Carefully read the content of this manual before installing the air conditioner and store the manual in a safe place in order to be able to use it as reference after installation.
- ▶ For maximum safety, installers should always carefully read the following warnings.
- ▶ Store the operation and installation manual in a safe location and remember to hand it over to the new owner if the air conditioner is sold or transferred.
- ▶ This manual explains how to install an indoor unit with a split system with two SAMSUNG units. The use of other types of units with different control systems may damage the units and invalidate the warranty. The manufacturer shall not be responsible for damages arising from the use of non compliant units.
- ▶ The manufacturer shall not be responsible for damage originating from unauthorized changes or the improper connection of electric and requirements set forth in the "Operating limits" table, included in the manual, shall immediately invalidate the warranty.
- ▶ The air conditioner should be used only for the applications for which it has been designed: the indoor unit is not suitable to be installed in areas used for laundry.
- ▶ Do not use the units if damaged. If problems occur, switch the unit off and disconnect it from the power supply.
- ▶ In order to prevent electric shocks, fires or injuries, always stop the unit, disable the protection switch and contact SAMSUNG's technical support if the unit produces smoke, if the power cable is hot or damaged or if the unit is very noisy.
- ▶ Always remember to inspect the unit, electric connections, refrigerant tubes and protections regularly. These operations should be performed by qualified personnel only.
- ▶ The unit contains moving parts, which should always be kept out of the reach of children.
- ▶ Do not attempt to repair, move, alter or reinstall the unit. If performed by unauthorized personnel, these operations may cause electric shocks or fires.
- ▶ Do not place containers with liquids or other objects on the unit.
- ▶ All the materials used for the manufacture and packaging of the air conditioner are recyclable.
- ▶ The packing material and exhaust batteries of the remote controller(optional) must be disposed of in accordance with current laws.
- ▶ The air conditioner contains a refrigerant that has to be disposed of as special waste. At the end of its life cycle, the air conditioner must be disposed of in authorized centers or returned to the retailer so that it can be disposed of correctly and safely.





Installing the unit

IMPORTANT: When installing the unit, always remember to connect first the refrigerant tubes, then the electrical lines.

Always disassemble the electric lines before the refrigerant tubes.

- ▶ Upon receipt, inspect the product to verify that it has not been damaged during transport. If the product appears damaged, DO NOT INSTALL it and immediately report the damage to the carrier or retailer (if the installer or the authorized technician has collected the material from the retailer.)
- ▶ After completing the installation, always carry out a functional test and provide the instructions on how to operate the air conditioner to the user.
- ▶ Do not use the air conditioner in environments with hazardous substances or close to equipment that release free flames to avoid the occurrence of fires, explosions or injuries.
- ▶ Our units should be installed in compliance with the spaces shown in the installation manual, to ensure accessibility from both sides and allow repairs or maintenance operations to be carried out. The unit's components should be accessible and easy to disassemble without endangering people and objects.
For this reason, when provisions of the installation manual are not complied with, the cost required to access and repair the units (in SAFETY CONDITIONS, as set out in prevailing regulations) with harnesses, ladders, scaffolding or any other elevation system will NOT be considered part of the warranty and will be charged to the end customer.

Power supply line, fuse or circuit breaker

- ▶ Always make sure that the power supply is compliant with current safety standards. Always install the air conditioner in compliance with current local safety standards.
- ▶ Always verify that a suitable grounding connection is available.
- ▶ Verify that the voltage and frequency of the power supply comply with the specifications and that the installed power is sufficient to ensure the operation of any other domestic appliance connected to the same electric lines.
- ▶ Always verify that the cut-off and protection switches are suitably dimensioned.
- ▶ Verify that the air conditioner is connected to the power supply in accordance with the instructions provided in the wiring diagram included in the manual.
- ▶ Always verify that electric connections (cable entry, section of leads, protections...) are compliant with the electric specifications and with the instructions provided in the wiring scheme. Always verify that all connections comply with the standards applicable to the installation of air conditioners.
- ▶ **Devices disconnected from the power supply should be completely disconnected in the condition of overvoltage category.**
- ▶ Be sure not to perform power cable modification, extension wiring, and multiple wire connection.
 - It may cause electric shock or fire due to poor connection, poor insulation, or current limit override.
 - When extension wiring is required due to power line damage, refer to "How to connect your extended power cables" in the installation manual.



CAUTION

- Make sure that you earth the cables.
 - Do not connect the earth wire to the gas pipe, water pipe, lighting rod or telephone wire. If earthing is not complete, electric shock or fire may occur.
- Install the circuit breaker.
 - If the circuit breaker is not installed, electric shock or fire may occur.
- Make sure that the condensed water dripping from the drain hose runs out properly and safely.
- Install the power cable and communication cable of the indoor and outdoor unit at least 1 m away from the electric appliance.
- Install the indoor unit away from lighting apparatus using the ballast.
 - If you use the wireless remote control, reception error may occur due to the ballast of the lighting apparatus.
- Do not install the air conditioner in following places.
 - Place where there is mineral oil or arsenic acid. Resin parts flame and the accessories may drop or water may leak. The capacity of the heat exchanger may reduce or the air conditioner may be out of order.
 - The place where corrosive gas such as sulfurous acid gas generates from the vent pipe or air outlet. The copper pipe or connection pipe may corrode and refrigerant may leak.
 - The place where there is a machine that generates electromagnetic waves. The air conditioner may not operate normally due to control system.
 - The place where there is a danger of existing combustible gas, carbon fiber or flammable dust. The place where thinner or gasoline is handled. Gas may leak and it may cause fire.





Preparation for installation

When deciding on the location of the air conditioner with the owner, the following restrictions must be taken into account.

General

Do NOT install the air conditioner in a location where it will come into contact with the following elements :

- ▶ Combustible gases
- ▶ Saline air
- ▶ Machine oil
- ▶ Sulphide gas
- ▶ Special environmental conditions







If you must install the unit in such conditions, first consult your dealer.

Avoid installing the air conditioner :

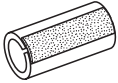
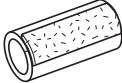
- ▶ In areas where it is exposed to direct sunlight. Close to heat sources.
- ▶ In damp areas or locations where it could come into contact with water. (for example rooms used for laundry)
- ▶ In areas where curtains and furniture could affect the supply and discharge of air.
- ▶ Without leaving the required minimum space around the unit. (as shown in the drawing)
- ▶ In scarcely ventilated areas.
- ▶ On surfaces that are unable to support the weight of the unit without deforming, breaking or causing vibrations during the use of the air conditioner.
- ▶ In a position that does not enable the condensate drainage pipe to be correctly installed. (at the end of the installation. It is always essential to check the efficiency of the drainage system)

Accessories

- ▶ The following accessories are supplied with the indoor unit.
The type and quantity may differ depending on the specifications.

Pattern sheet (1)	Insulation pipe (Liquid side1, gas side1)	Insulation drain hose (1)	Cable-tie (6)
			
Drain hose (1)	Installation manual (1)	User manual (1)	Clamp (1)
			





Deciding on where to install the indoor unit

Indoor unit

- ▶ There must be no obstacles near the air inlet and outlet.
- ▶ Install the indoor unit on a ceiling that can support its weight.
- ▶ Maintain sufficient clearance around the indoor unit.
- ▶ Make sure that the water dripping from the drain hose runs away correctly and safely.
- ▶ The indoor unit must be installed in this way, that they are out of public access. (Not touchable by the users)



• If you install the cassette type indoor unit on the ceiling with humidity over 80 %, you must apply extra 10 mm of polyethylene foam or other insulation with similar material on the body of the indoor unit.

Space requirements for indoor unit

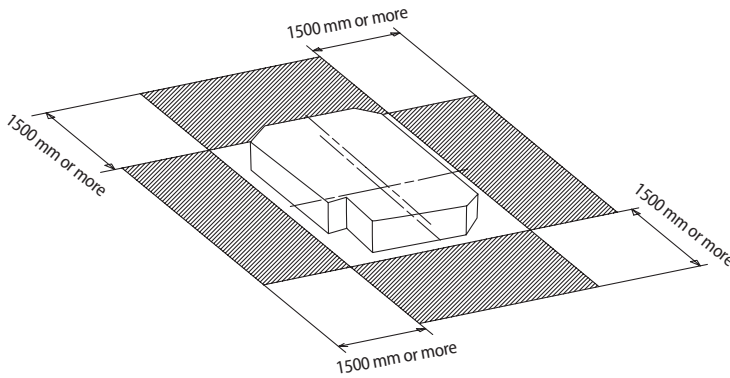

- ▶ When installing a cassette type indoor unit on the ceiling and its installation condition is temperature over 27 °C and humidity over 80 %, install a 10 mm thickness of polyethylene insulation or similar type of insulation on the indoor unit body.



Deciding on where to install the indoor unit

Insulation installation guide

- ▶ Cut the part where pipes are pulled out or some curved part for insulating work.
- ▶ When insulating a connecting duct, the outlet and inlet part (front, back) should be insulated together.

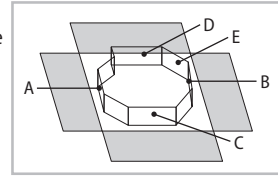

Thickness: more than 10 mm

Indoor unit			A	B	C	D	E
Cassette type	4way Cassette<L> (840x288x840)	AC071/100/125JN4CEH	910X235	940X235	610X235	650X235	870X870



- The units must be installed according to distances declared, in order to permit accessibility from each side, either to guarantee correct operation of maintenance or repairing products. The unit's parts must be reachable and removable completely under safety condition (for people or things).
- Do not hold the discharge while carrying the indoor unit to avoid the possibility of breakage. You must hold the hanger plate on the corner and carry the indoor unit.

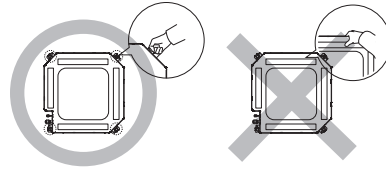

Required space for an indoor unit installation

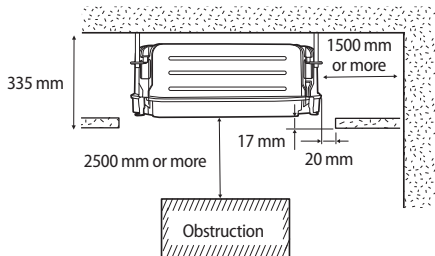



Drawing of the indoor unit

Unit : mm

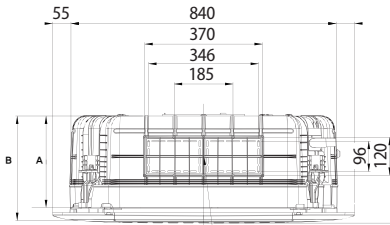
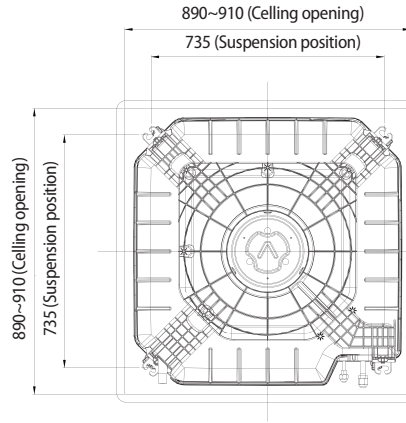
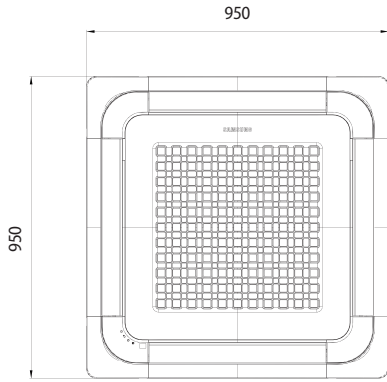

Sub duct connection

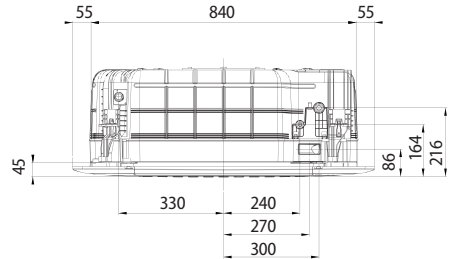

ENGLISH

		MODEL	
		AC071JN4CEH	AC100JN4CEH AC125JN4CEH
A	mm	288	
B	mm	337	
Net dimension	mm	840 X 288 X 840	
Net weight	kg	18	20
Liquid pipe connection		3/8"	
Gas pipe connection		5/8"	
Drain Hose connection	mm	OD : Ø32.0, ID : Ø26.5	



Indoor unit installation

When deciding on the location of the air conditioner with the owner, the following restrictions must be taken into account.

1. Determine the position of the pipe and drain hose hole as seen in the picture and drill the hole with an inner diameter of 65 mm so that it slants slightly downwards.



• Since the diagram is made of paper, it may shrink or stretch slightly due to temperature or humidity. For this reason, before drilling the holes maintain the correct dimensions between the markings.

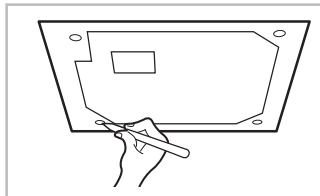

2. Insert bolt anchors, use existing ceiling supports or construct a suitable support as shown in figure.
3. Install the suspension bolts depending on the ceiling type.



• Ensure that the ceiling is strong enough to support the weight of the indoor unit. Before hanging the unit, test the strength of each attached suspension bolt.
• If the length of suspension bolt is more than 1.5 m, it is required to prevent vibration.

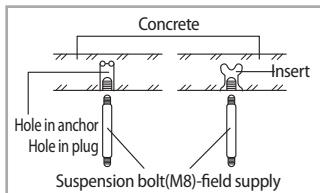

4. Screw eight nuts to the suspension bolts making space for hanging the indoor unit.



• You must install all the suspension rods.
• It is important to leave sufficient space in the false ceiling to allow access for maintenance or repairs to the drainage pipe connection, the refrigerant pipe connection, or to remove the unit if necessary.

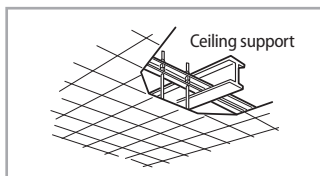

5. Hang the indoor unit to the suspension bolts between two nuts.



• Piping must be laid and connected inside the ceiling when suspending the unit. If the ceiling is already constructed, lay the piping into position for connection to the unit before placing the unit inside the ceiling.

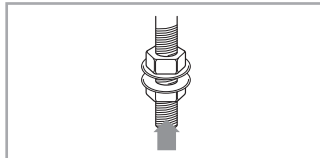

6. Screw the nuts to suspend the unit. Cut a pad stopper and place it on the bracket at this time.
7. Adjust the unit to the appropriate position considering the installation area for the front panel.

- 1) Place the pattern sheet on the indoor unit.
- 2) Adjust a space between the ceiling and the indoor unit by using the gauge of dimensions.
- 3) Fix the indoor unit securely after adjusting level of the unit by using a leveler.
- 4) Remove the pattern sheet, connect the other cables and install the front panel.

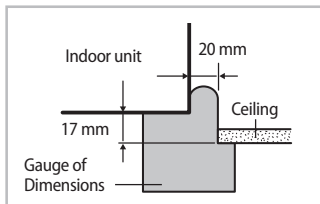
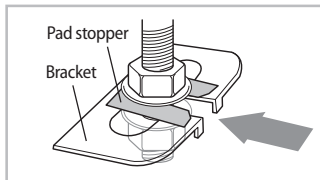



Purging the unit

From factory the unit is supplied and set with a pre-charge of nitrogen gas. (insert gas) Therefore, all insert gas must be purged before connecting the assembly piping.

Unscrew the pinch pipe at the end of each refrigerant pipe.

Result : All inert gas escapes from the indoor unit.



- To prevent dirt or foreign objects from getting into the pipes during installation, do NOT remove the pinch pipe completely until you are ready to connect the piping.

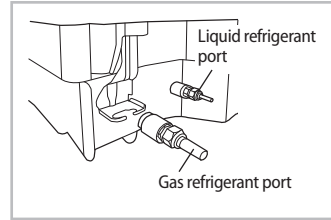

Connecting the refrigerant pipe

There are two refrigerant pipes of different diameters :

- A smaller one for the liquid refrigerant
- A larger one for the gas refrigerant
- The inside of copper pipe must be clean & has no dust

- Remove the pinch pipe on the pipes and connect the assembly pipes to each pipe, tightening the nuts, first manually and then with a torque wrench, a spanner applying the following torque.

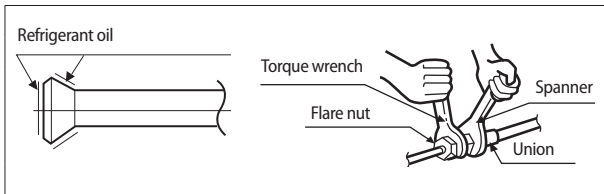

Outer Diameter (D)	Torque (N·m)
ø6.35 mm	14~18
ø9.52 mm	34~42
ø12.70 mm	49~61
ø15.88 mm	68~82
ø19.05 mm	100~120



- If the pipes must be shortened refer to page 10.

- Must use insulator which is thick enough to cover the refrigerant tube to protect the condensate water on the outside of pipe falling onto the floor and the efficiency of the unit will be better.
- Cut off any excess foam insulation.
- Be sure that there must be no crack or wave on the bended area.
- It would be necessary to double the insulation thickness(10 mm or more) to prevent condensation even on the insulator when if the installed area is warm and humid.
- Do not use joints or extensions for the pipes that connect the indoor and outdoor unit. The only permitted connections are those for which the units are designed.

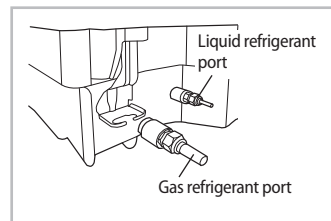

- Connect the indoor and outdoor units using pipes with flared connections(not supplied). For the lines, use insulated, unwelded, degreased and deoxidized copper pipe (Cu DHP type to ISO 1337 or UNI EN 12735-1), suitable for operating pressures of at least 4200kPa and for a burst pressure of at least 20700kPa. Copper pipe for hydro-sanitary applications is completely unsuitable.
- For sizing and limits (height difference, line length, max. bends, refrigerant charge, etc.) see the outdoor unit installation manual.
- All refrigerant connection must be accessible, in order to permit either unit maintenance or removing it completely.



Cutting/Flaring the Pipes

1. Make sure that you have the required tools available. (pipe cutter, reamer, flaring tool and pipe holder)
2. If you wish to shorten the pipes, cut it with a pipe cutter, taking care to ensure that the cut edge remains at a 90° angle with the side of the pipe. Refer to the illustrations below for examples of edges cut correctly and incorrectly.

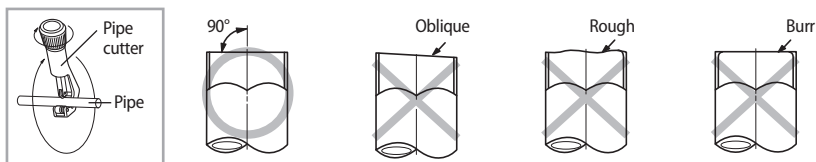

3. To prevent any gas from leaking out, remove all burrs at the cut edge of the pipe, using a reamer.
4. Slide a flare nut on to the pipe and modify the flare.

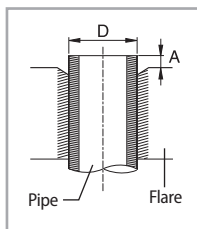

Outer Diameter (D)	Depth (A)
ø6.35 mm	1.3 mm
ø9.52 mm	1.8 mm
ø12.70 mm	2.0 mm
ø15.88 mm	2.2 mm
ø19.05 mm	2.2 mm

5. Check that the flaring is correct, referring to the illustrations below for examples of incorrect flaring.



6. Align the pipes and tighten the flare nuts first manually and then with a torque wrench, applying the following torque.

Valve	Flare nut		Valve cap		Pressure port cap		Valve needle		Pressure port	
	Wrench(mm)	N·m	Wrench(mm)	N·m	Wrench(mm)	N·m	Wrench(mm)	N·m	Wrench(mm)	N·m
1/4"	17	18	23	20	18	16~18	Allen(hex.) 5	9	-	0.34
3/8"	22	42	23	20	18	16~18	Allen(hex.) 5	9	-	0.34
1/2"	26	55	29	40	18	16~18	Allen(hex.) 5	13	-	0.34
5/8"	29	65	29	40	18	16~18	Allen(hex.) 5	13	-	0.34
3/4"	36	100	38	40	18	16~18	Allen(hex.) 5	13	-	0.34



- If the pipes require brazing ensure that OFN (Oxygen Free Nitrogen) is flowing through the system.
- Nitrogen blowing pressure range is 0.02 ~ 0.05 MPa.

Performing leak test & insulation

Leak test

To identify potential gas leaks on the indoor unit, inspect the connection area of each refrigerant pipe using a leak detector for R-410A.

Before recreating the vacuum and recirculating the refrigerant gas, it is advisable to pressurize the whole system with nitrogen (using a cylinder with pressure reducer) at a pressure above 40 bar in order to immediately detect leaks on the refrigerant fittings.

Made vacuum for 15 minutes and pressurising system with nitrogen.

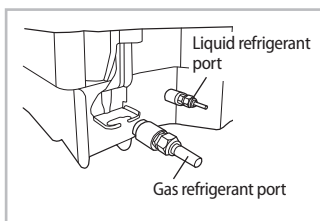

- If the pipes require brazing ensure that OFN (Oxygen Free Nitrogen) is flowing through the system.

Insulation

Once you have checked that there are no leaks in the system, you can insulate the piping and hose.

1. To avoid condensation problems, place Acrylonitrile Butadien Rubber separately around each refrigerant pipe.



- Always make the seam of pipes face upwards.



- The insulation has to be produced in full compliance of European regulation reg. EEC / EU 2037/ 2000 that requires the use of sheaths insulation form without using CFC and HCFC gases for health and the environment.

2. Wind insulating tape around the pipes and drain hose avoiding to compress the insulation too much.
3. Finish wrapping insulating tape around the rest of the pipes leading to the outdoor unit.
4. The pipes and electrical cables connecting the indoor unit with the outdoor unit must be fixed to the wall with suitable ducts.



- All refrigerant connection must be accessible, in order to permit either unit maintenance or removing it completely.

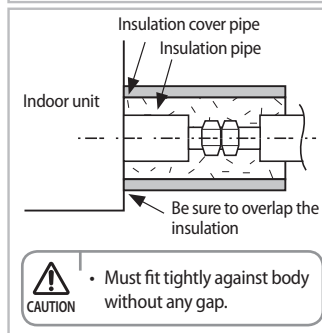
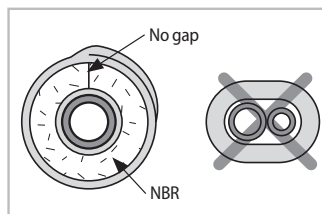

5. Select the insulation of the refrigerant pipe.
 - ▶ Insulate the gas side and liquid side pipe referring to the thickness according to the pipe size.
 - ▶ Less than indoor temperature of 30 °C and humidity of 85 % is the standard condition. If installing in a high humidity condition, use one grade thicker insulator by referring to the table below. If installing in an unfavorable conditions, use thicker one.
 - ▶ Insulator's heat-resistance temperature should be more than 120 °C.



Performing leak test & insulation

Pipe	Pipe size	Insulation Type (Heating/Cooling)		Remarks
		Standard [Less than 30 °C, 85 %]	High humidity [Over 30 °C, 85 %]	
		EPDM, NBR		
Liquid pipe	Ø6.35 ~ Ø9.52	9 t	9 t	Internal temperature is higher than 120 °C
	Ø12.7 ~ Ø19.05	13 t	13 t	
Gas pipe	Ø6.35	13 t	19 t	
	Ø9.52	19 t	25 t	
	Ø12.70			
	Ø15.88			
Ø19.05				

- When installing insulation in places and conditions below, use the same insulation that is used for high humidity conditions.

Geological condition

- High humidity places such as shoreline, hot spring, near lake or river, and ridge (when the part of the building is covered by earth and sand.)

Operation purpose condition

- Restaurant ceiling, sauna, swimming pool etc.

Building construction condition

- The ceiling frequently exposed to moisture and cooling is not covered.
e.g. The pipe installed at a corridor of a dormitory and studio or near an exit that opens and closes frequently.
- The place where the pipe is installed is highly humid due to the lack of ventilation system.

Drainpipe and drain hose installation

1. Push the supplied drain hose as far as possible over the drain socket.
2. Tighten the metal clamp as shown in the picture.
3. Wrap the supplied large sealing pad over the metal clamp and drain hose to insulate and fix it with clamps.
4. Insulate the complete drain piping inside the building (field supply).
If the drain hose cannot be sufficiently set on a slope, fit the hose with drain raising piping (field supply).
5. Push the drain hose up to insulation when connecting the drain hose to drain socket.

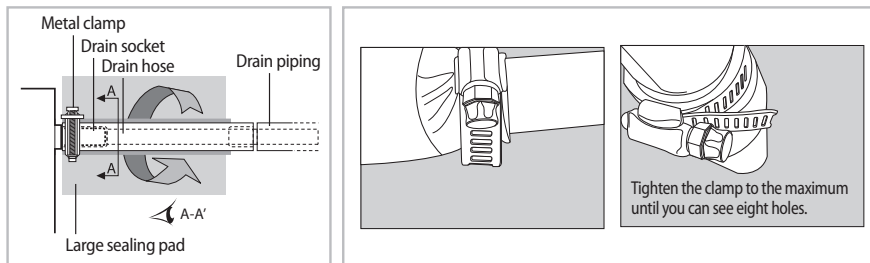



Drainpipe and drain hose installation



• Check that the indoor unit is level with the ceiling by using the leveler.

Install air ventilation to drain condensate water smoothly.

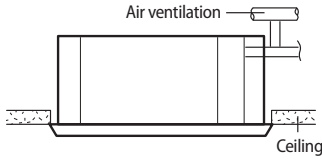

Do not give the hose and upward gradient after the connection port. This will cause water to flow backwards when the unit is stopped, resulting in water leaks.

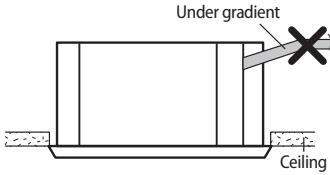

Install horizontally

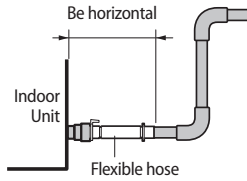

Max. allowable bending angle

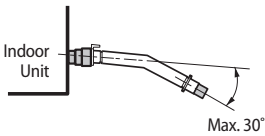

If it is necessary to increase the height of the drainpipe, install the drainpipe straightly within 300 mm from the drain hose port. If it is raised higher than 550 mm, there can be water leaks.

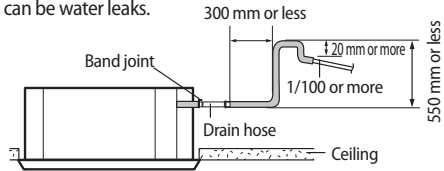

Do not apply force to the piping on the unit side when connecting the drain hose. The hose should not be allowed to hang loose from its connection to the unit. Fasten the hose to a wall, frame or other support as close to the unit as possible.

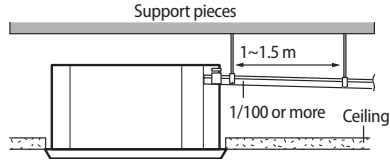

Max. allowable axis gap

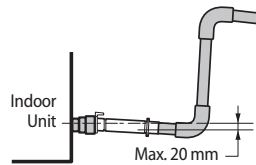

• If a concentrated drain pipe is installed, refer to the figure below.

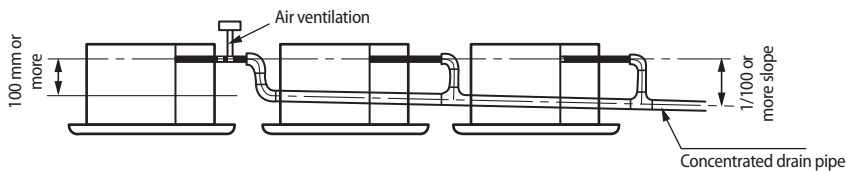

Drainpipe and drain hose installation

Testing the drainage

1. Check the leak test at the connection part of the flexible hose and the distributing pipe (PVC).
 - 1) Connect a general hose to the connection part of the flexible hose of the indoor unit, and pour in some water.
 - 2) After pouring some water, reassemble the rubber cap on the connection part of a flexible hose of the indoor unit and tighten it with a band firmly to prevent leakage.
 - 3) Check the leak test at the part where the adhesive for the flexible hose and the distributing pipe is used.

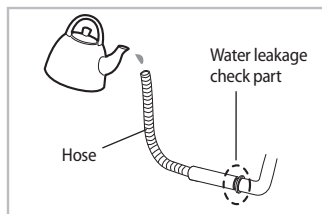

- The leak test should be performed for more than 24 hours at least.

2. Check the condensed water drainage.
 - 1) Pour about 2 liters of water into the indoor unit drain board as shown in the picture.
 - 2) a. When the electric cable connection is completed;
 - Turn the indoor unit and outdoor unit on.
 - Operate the Cool mode.

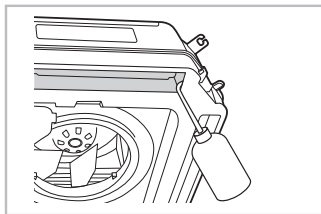

- Only in Cool mode, you can check the correct operation of the drain pump.

- b. When the electric cable connection has not been completed;
 - Remove the control box cover of the indoor unit.
 - Connect the power supply of 220 V, 50 Hz to L, N terminal.
 - Reassemble the control box cover and turn on the indoor unit.



- When the float switch is not detected due to insufficient water on the drain board, the drain pump will not work.
- If power supply is directly connected to L, N terminal, communication error message might appear.
- After completing the drainage check, turn the unit off and disconnect the power supply.
- Reassemble the control box cover.

- 3) Check whether the drain pump works correctly.
- 4) Check whether the drainage is performing correctly at the end of the drain pipe.
- 5) Check for leakage at the drain pipe and drain pipe connection part.
- 6) When leakage occurs, check whether the indoor unit is level and check the drain hose connection part, drainpipe connection part and drain pump connection.
- 7) When the drainage check is completed and the condensed water remains on the drain board, remove the water.

Connecting the connection cord



- Always remember to connect the refrigerant pipes before performing the electric connections. When disconnecting the system, always disconnect the electric cables before disconnecting the refrigerant pipes.
- Always remember to connect the air conditioner to the grounding system before performing the electric connections.

The indoor unit is powered by the outdoor unit by means of a H07 RN-F connection cable (or a more power model), with insulation in synthetic rubber and jacket in polychloroprene(neoprene), in accordance with the requirements of standard EN 60335-2-40.

1. Remove the screw on the electrical component box and remove the cover plate.
2. Route the connection cord through the side of the indoor unit and connect the cable to terminals; refer to the figure below.
3. Route the other end of the cable to the outdoor unit through the ceiling & the hole on the wall.
4. Reassemble the electrical component box cover, carefully tightening the screw.

Wiring diagram

1 phase

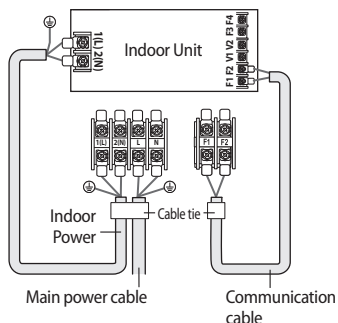

3 phase

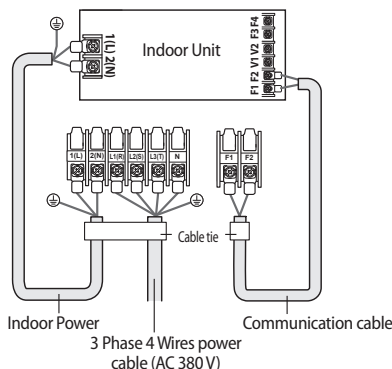

Between Indoor and Outdoor Connection cable Specifications(Common in use)

Indoor Power supply			Communication Cable
Power Supply	Max/Min(V)	Indoor Power cable	
1Ø, 220-240V, 50Hz	±10 %	1.5 mm ² T, 3 wires	0.75~1.5 mm ² , 2 wires

- * Supply cords of parts of appliances for outdoor use shall not be lighter than polychloroprene sheathed flexible cord. (Code designation IEC:60245 IEC 57 / CENELEC: H05RN-F or IEC:60245 IEC66 / CENELEC H07RN-F)
- * Screws on terminal block must not be unscrewed with the torque less than 12 kgf·cm.
- * Since it has the external power supply, refer to the outdoor unit installation manual for MAIN POWER.

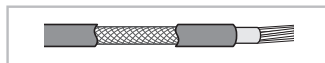

When installing the indoor unit in a computer room, use the double shielded(Tape aluminum / polyester braid + copper)cable of FROHH2R type.

Terminal Block SPEC (Indoor)

AC POWER : M4 SCREW

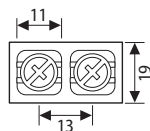

COMMUNICATION : M3.5 SCREW

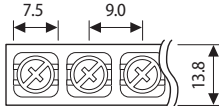

Tightening Torque (kgf · cm)





M3.5	8.0~12.0
M4	12.0~18.0

* 1N·m=10kgf·cm



How to connect your extended power cables

1. Prepare the following tools.

Tools	Crimping pliers	Connection sleeve (mm)	Insulation tape	Contraction tube (mm)
Spec	MH-14	20xØ6.5(HxOD)	Width 19mm	70xØ8.0(LxOD)
Shape				

2. As shown in the figure, peel off the shields from the rubber and wire of the power cable.

- Peel off 20 mm of cable shields from the pre-installed tube.



- For information about the power cable specifications for indoor and outdoor units, refer to the installation manual.
- After peeling off cable wires from the pre-installed tube, insert a contraction tube.

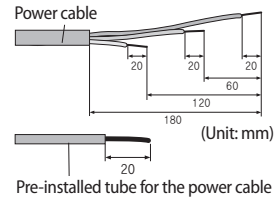

3. Insert both sides of core wire of the power cable into the connection sleeve.

► Method 1

Push the core wire into the sleeve from both sides.

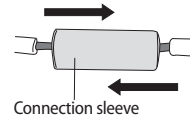

► Method 2

Twist the wire cores together and push it into the sleeve.

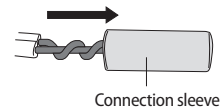

4. Using a crimping tool, compress the two points and flip it over and compress another two points in the same location.

- The compression dimension should be 8.0.
- After compressing it, pull both sides of the wire to make sure it is firmly pressed.

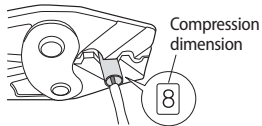

► Method 1

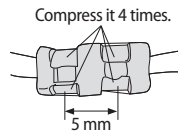

► Method 2

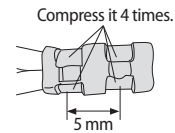



5. Wrap it with the insulation tape twice or more and position your contraction tube in the middle of the insulation tape.

Three or more layers of insulation are required.

▶ Method 1

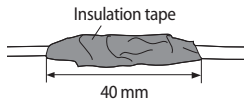

▶ Method 2

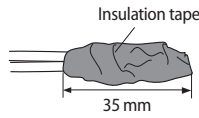

6. Apply heat to the contraction tube to contract it.

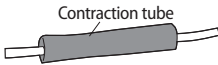

7. After tube contraction work is completed, wrap it with the insulation tape to finish.



CAUTION

- Make sure that the connection parts are not exposed to outside.
- Be sure to use insulation tape and a contraction tube made of approved reinforced insulating materials that have the same level of withstand voltage with the power cable. (Comply with the local regulations on extensions.)

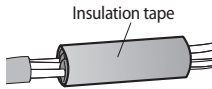

WARNING

- In case of extending the electric wire, please DO NOT use a round-shaped Pressing socket.
- Incomplete wire connections can cause electric shock or a fire.

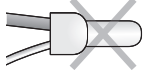

Setting an indoor unit address and installation option

- ▶ Set the indoor unit address and installation option with remote controller option.
Set the each option separately since you cannot set the ADDRESS setting and indoor unit installation setting option at the same time. You need to set twice when setting indoor unit address and installation option.

The procedure of setting option

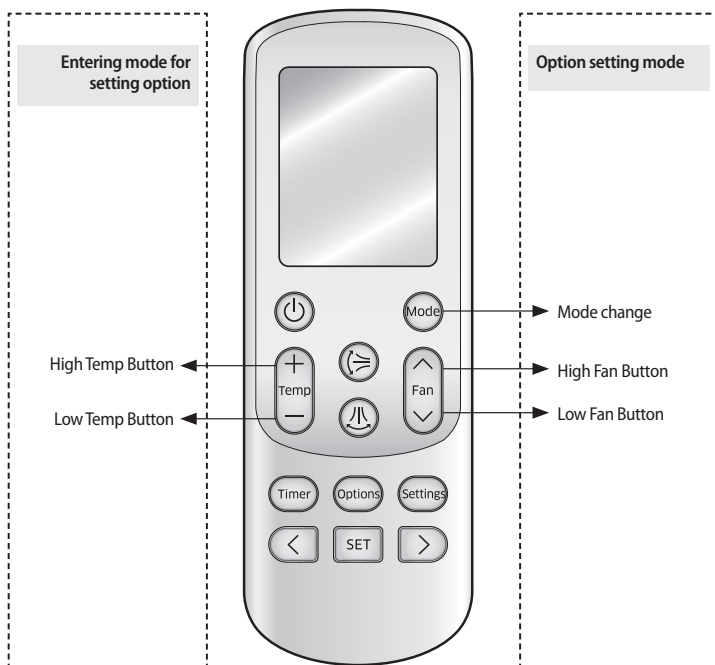

Step 1. Entering mode to set option

1. Remove batteries from the remote controller.
2. Insert batteries and enter the option setting mode while pressing High Temp button and Low Temp button.
3. Check if you have entered the option setting status.

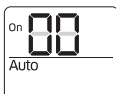

Step 2. The procedure of option setting

After entering the option setting status, select the option as listed below.









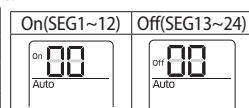





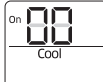
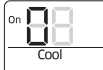
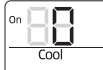

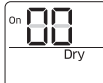
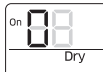
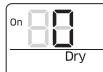
Option setting is available from SEG1 to SEG 24

- SEG1, SEG7, SEG13, SEG19 are not set as page option.
- Set the SEG2~SEG6, SEG8~SEG12 as ON status and SEG14~18, SEG20~24 as OFF status.

SEG1	SEG2	SEG3	SEG4	SEG5	SEG6	SEG7	SEG8	SEG9	SEG10	SEG11	SEG12	On(SEG1~12)	Off(SEG13~24)
0	X	X	X	X	X	1	X	X	X	X	X	On Auto	Off Auto
SEG13	SEG14	SEG15	SEG16	SEG17	SEG18	SEG19	SEG20	SEG21	SEG22	SEG23	SEG24		
2	X	X	X	X	X	3	X	X	X	X	X		

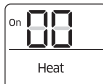
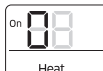
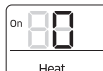

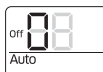

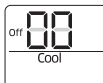





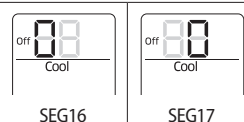

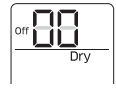
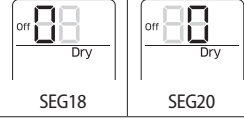
Option setting	Status
<p>1. Setting SEG2, SEG3 option Press Low Fan button(∨) to enter SEG2 value. Press High Fan button(∧) to enter SEG3 value. Each time you press the button, $\text{ON} \rightarrow \text{OFF} \rightarrow \dots \rightarrow \text{ON} \rightarrow \text{OFF}$ will be selected in rotation.</p>	  SEG2 SEG3
<p>2. Setting Cool mode  Press Mode button to be changed to Cool mode in the ON status.</p>	
<p>3. Setting SEG4, SEG5 option Press Low Fan button(∨) to enter SEG4 value. Press High Fan button(∧) to enter SEG5 value. Each time you press the button, $\text{ON} \rightarrow \text{OFF} \rightarrow \dots \rightarrow \text{ON} \rightarrow \text{OFF}$ will be selected in rotation.</p>	  SEG4 SEG5
<p>4. Setting Dry mode  Press Mode button to be changed to DRY mode in the ON status.</p>	
<p>5. Setting SEG6, SEG8 option Press Low Fan button(∨) to enter SEG6 value. Press High Fan button(∧) to enter SEG8 value. Each time you press the button, $\text{ON} \rightarrow \text{OFF} \rightarrow \dots \rightarrow \text{ON} \rightarrow \text{OFF}$ will be selected in rotation.</p>	  SEG6 SEG8
<p>6. Setting Fan mode  Press Mode button to be changed to FAN mode in the ON status.</p>	
<p>7. Setting SEG9, SEG10 option Press Low Fan button(∨) to enter SEG9 value. Press High Fan button(∧) to enter SEG10 value. Each time you press the button, $\text{ON} \rightarrow \text{OFF} \rightarrow \dots \rightarrow \text{ON} \rightarrow \text{OFF}$ will be selected in rotation.</p>	  SEG9 SEG10
<p>8. Setting Heat mode  Press Mode button to be changed to HEAT mode in the ON status.</p>	
<p>9. Setting SEG11, SEG12 option Press Low Fan button(∨) to enter SEG11 value. Press High Fan button(∧) to enter SEG12 value. Each time you press the button, $\text{ON} \rightarrow \text{OFF} \rightarrow \dots \rightarrow \text{ON} \rightarrow \text{OFF}$ will be selected in rotation.</p>	  SEG11 SEG12
<p>10. Setting Auto mode  Press Mode button to be changed to AUTO mode in the OFF status.</p>	
<p>11. Setting SEG14, SEG15 option Press Low Fan button(∨) to enter SEG14 value. Press High Fan button(∧) to enter SEG15 value. Each time you press the button, $\text{ON} \rightarrow \text{OFF} \rightarrow \dots \rightarrow \text{ON} \rightarrow \text{OFF}$ will be selected in rotation.</p>	  SEG14 SEG15
<p>12. Setting Cool mode  Press Mode button to be change to Cool mode in the OFF status.</p>	

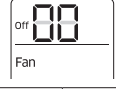
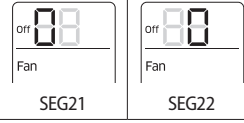

Setting an indoor unit address and installation option

Option setting	Status
<p>13. Setting SEG16, SEG17 option</p> <p>Press Low Fan button(V) to enter SEG16 value.</p> <p>Press High Fan button(^) to enter SEG17 value.</p> <p>Each time you press the button, 0 → 1 → ... 9 → F will be selected in rotation.</p>	
<p>14. Setting Dry mode</p> <p> Press Mode button to be change to Dry mode in the OFF status.</p>	
<p>15. Setting SEG18, SEG20 option</p> <p>Press Low Fan button(V) to enter SEG18 value.</p> <p>Press High Fan button(^) to enter SEG20 value.</p> <p>Each time you press the button, 0 → 1 → ... 9 → F will be selected in rotation.</p>	
<p>16. Setting Fan mode</p> <p> Press Mode button to be change to Fan mode in the OFF status.</p>	
<p>17. Setting SEG21, SEG22 option</p> <p>Press Low Fan button(V) to enter SEG21 value.</p> <p>Press High Fan button(^) to enter SEG22 value.</p> <p>Each time you press the button, 0 → 1 → ... 9 → F will be selected in rotation.</p>	
<p>18. Setting Heat mode</p> <p> Press Mode button to be change to HEAT mode in the OFF status.</p>	
<p>19. Setting SEG23, SEG24 mode</p> <p>Press Low Fan button(V) to enter SEG23 value.</p> <p>Press High Fan button(^) to enter SEG24 value.</p> <p>Each time you press the button, 0 → 1 → ... 9 → F will be selected in rotation.</p>	

Step 3. Check the option you have set

After setting option, press  button to check whether the option code you input is correct or not.

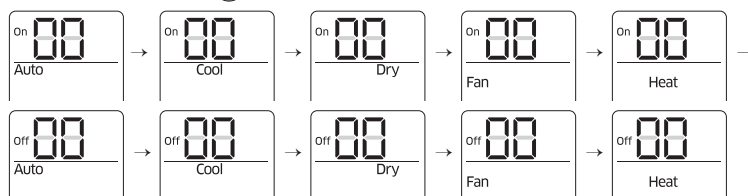

Step 4. Input option

Press the operation button  with the direction of remote control for set.
For the correct option setting, you must input the option twice.

Step 5. Check operation

- 1) Reset the indoor unit by pressing the RESET button of indoor unit or outdoor unit.
- 2) Take the batteries out of the remote controller and insert them again and then press the operation button.



Setting an indoor unit address (MAIN/RMC)

- Check whether power is supplied or not.
 - When the indoor unit is not plugged in, there should be additional power supply in the indoor unit.
- The panel(display) should be connected to an indoor unit to receive option.
- Before installing the indoor unit, assign an address to the indoor unit according to the air conditioning system plan.
- Assign an indoor unit address by wireless remote controller.
 - The initial setting status of indoor unit ADDRESS(MAIN/RMC) is "0A0000-100000-200000-300000".
 - There is no need to assign extra ADDRESS for 1:1 installation between indoor unit and outdoor unit.
 - Main address will be set automatically and manual address setting will be only available when outdoor unit option status is set as 'Manual address'

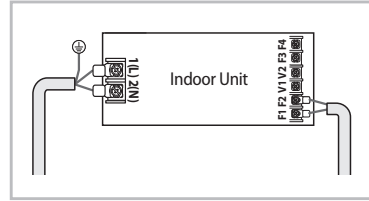

Option No. : 0AXXXX-1XXXXX-2XXXXX-3XXXXX

Option	SEG1		SEG2		SEG3		SEG4	SEG5		SEG6		
Explanation	PAGE		MODE		Setting Main address		RESERVED	RESERVED	The unit digit of an indoor unit			
Remote Controller Display												
Indication and Details	Indication	Details	Indication	Details	Indication	Details			Indication	Details		
	0		A		0	No Main address			0~3	A single digit		
					1	Main address setting mode						
Option	SEG7		SEG8		SEG9		SEG10	SEG11		SEG12		
Explanation	PAGE		RESERVED		Setting RMC address		RESERVED	Group channel(*16)		Group address		
Remote Controller Display												
Indication and Details	Indication	Details	RESERVED		Indication	Details		Indication	Details	Indication	Details	
	1				0	No RMC address			RMC1	0~2	RMC2	0~F
					1	RMC address setting mode						



- You can set the Main address from 0~3 range and if you input other numbers, 'communication error' will occur.
- When "A"~"F" is entered to SEG5~6, the indoor unit MAIN ADDRESS is not changed.
- If you set the SEG 3 as 0, the indoor unit will maintain the previous MAIN ADDRESS even if you input the option value of SEG5~6.
- If you set the SEG 9 as 0, the indoor unit will maintain previous RMC ADDRESS even if you input the option value of SEG11~12.



Setting an indoor unit address and installation option

Setting an indoor unit installation option (suitable for the condition of each installation location)

1. Check whether power is supplied or not.
 - When the indoor unit is not plugged in, there should be additional power supply in the indoor unit.
2. The panel(display) should be connected to an indoor unit to receive option.
3. Set the installation option according to the installation condition of an air conditioner.
 - The default setting of an indoor unit installation option is "02000-100000-200000-300000".
 - Individual control of a remote controller(SEG20) is the function that controls an indoor unit individually when there is more than one indoor unit.
4. Set the indoor unit option by wireless remote controller.

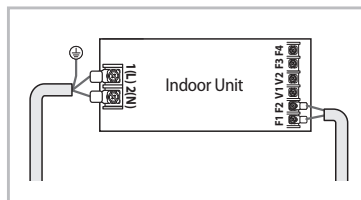

SEG1	SEG2	SEG3	SEG4	SEG5	SEG6
0	2	RESERVED	Exterior temperature sensor	Central control	Fan RPM compensation
SEG7	SEG8	SEG9	SEG10	SEG11	SEG12
1	Drain pump	RESERVED	RESERVED	EEV Step when heating stops	RESERVED
SEG13	SEG14	SEG15	SEG16	SEG17	SEG18
2	External control	External control output	S-Plasma ion	Buzzer	Number of hours using filter
SEG19	SEG20	SEG21	SEG22	SEG23	SEG24
3	Individual control of a remote controller	Heating setting compensation	RESERVED	RESERVED	RESERVED

- ▶ 1WAY/2WAY/4WAY MODEL : Drain pump(SEG8) will be set to 'USE + 3 minute delay' even if the drain pump is set to 0.
- ▶ 1WAY/2WAY/4WAY,DUCT MODEL : Number of hours using filter(SEG18) will be set to '1000 hour' even if the SEG18 is set to except for 2 or 6.
- ▶ If you input a number other than 0~4 of the individual control of the indoor unit(SEG20), the indoor is set as "indoor 1".
- ▶ 4WAY MODEL : Even when the value of Heating setting compensation(SEG21) is set to '0', it will be recognized as '5 °C'.



Option No. : 02XXXX-1XXXXX-2XXXXX-3XXXXX

Option	SEG1	SEG2	SEG3	SEG4	SEG5	SEG6	
Explanation	PAGE	MODE	RESERVED	Use of external temperature sensor	Use of central control	Fan RPM compensation	
Remote Controller Display							
Indication and Details	Indication	Details		Indication	Details	Indication	Details
	0			2		0	nonuse
				0	Disuse	1 High ceiling mode	
				1	Use	2 High purity kit	
						3 Noise reduction operation mode	
Option	SEG7	SEG8	SEG9	SEG10	SEG11	SEG12	
Explanation	PAGE	Use of drain pump	RESERVED	RESERVED	EEV Step when heating stops	RESERVED	
Remote Controller Display							
Indication and Details	Indication	Details			Indication		Details
	1				0 Disuse		
			1 Use				
			2 Use + 3minute delay				
					0 Default value		
					1 Noise reduction operation mode		
Option	SEG13	SEG14	SEG15	SEG16	SEG17	SEG18	
Explanation	PAGE	Use of external control	Setting the output of external control	S-Plasma ion	Buzzer control	Number of hours using filter	
Remote Controller Display							
Indication and Details	Indication	Details	0 Disuse	0 Thermo on	0 Disuse	0 Use of buzzer	2 1000 Hour
			1 ON/OFF Control	1 Operation on	1 Use	1 Non use of buzzer	6 2000 Hour
			2 OFF Control				
			3 Window ON/OFF Control				
Option	SEG19	SEG20	SEG21	SEG22	SEG23	SEG24	
Explanation	PAGE	Individual control of a remote controller	Heating setting compensation	RESERVED	RESERVED	RESERVED	
Remote Controller Display							
Indication and Details	Indication	Details	Indication				Details
			3				0 or 1 Indoor 1
			2 Indoor 2	1 2°C			
			3 Indoor 3	2 5°C			
		4 Indoor 4					



Setting an indoor unit address and installation option

Changing a particular option

You can change each digit of set option.

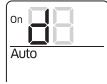
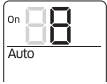
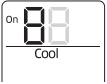
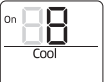
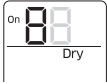
Option	SEG1		SEG2		SEG3		SEG4		SEG5		SEG6	
Explanation	PAGE		MODE		The option mode you want to change		The tens' digit of an option SEG you will change		The unit digit of an option SEG you will change		The changed value	
Remote Controller Display												
Indication and Details	Indication	Details	Indication	Details	Indication	Details	Indication	Details	Indication	Details	Indication	Details
		0		D		Option mode 0~F		Tens' digit of SEG 0~9		Unit digit of SEG 0~9		The changed value 0~F



- When changing a digit of an indoor unit address setting option, set the SEG3 as 'A'.
- When changing a digit of indoor unit installation option, set the SEG3 as '2'.

Ex) When setting the 'buzzer control' into disuse status.

Option	SEG1	SEG2	SEG3	SEG4	SEG5	SEG6
Explanation	PAGE	MODE	The option mode you want to change	The tens' digit of an option SEG you will change	The unit digit of an option SEG you will change	Changed value
Indication	0	D	2	1	7	1



Troubleshooting

Abnormal conditions	LED lamp display				Remarks
	Operation	Defrost	Timer	Filter	
Power reset		X	X	X	
Error of temperature sensor in the indoor unit (Open/Short)	X		X	X	
Error of heat exchanger sensor in the indoor unit (Open/Short)			X	X	
Error of fan motor in the indoor unit	X	X		X	
Error of the outdoor temperature sensor		X		X	
Error of the condensor temperature sensor		X		X	
Error of the discharge temperature sensor		X		X	
No communication for 2 minutes between indoor and outdoor unit (communication error for more than 2 minutes)	X			X	
Error of outdoor unit	X				
Error of the terminal block thermal fuse (Open)	X				
Detection of the float switch	X	X			
EEPROM ERROR					
EEPROM option error					
Outdoor valve clogging error		X			

● On ○ Flickering X Off

* If you turn off the air conditioner when the LED is flickering, the LED is also turned off.



SAMSUNG

