



SYSTEM AIR CONDITIONER

Indoor Unit Outdoor Unit

Model Name :

AC160JNHFKH	AC160JXAFKH
AC160JNHFKH	AC160JXAFNH
AC180JNHFKH	AC180JXAFNH
AC200JNHFKH	AC200JXAFNH
AC180JNHPKH	AC180JXAPNH
AC200JNHPKH	AC200JXAPNH

Model Code :

AC160JNHFKH/SA	AC160JXAFKH/SA
AC160JNHFKH/SA	AC160JXAFNH/SA
AC180JNHFKH/SA	AC180JXAFNH/SA
AC200JNHFKH/SA	AC200JXAFNH/SA
AC180JNHPKH/AR	AC180JXAPNH/AR
AC200JNHPKH/EU	AC200JXAPNH/EU

SERVICE *Manual*

AIR CONDITIONER

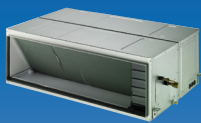

AC160JNHFKH
AC180JNHFKH
AC200JNHFKH
AC180JNHPKH
AC200JNHPKH



AC160JXAFKH
AC160JXAFNH
AC180JXAFNH
AC180JXAPNH



AC200JXAFNH
AC200JXAPNH

CONTENTS

1. Precautions
2. Product Specifications
3. Disassembly and Reassembly
4. Troubleshooting
5. PCB Diagram
6. Wiring Diagram
7. Reference Sheet

Contents

1. Precautions	1-1
1-1 Precautions for the Service	1-1
1-2 Precautions for the Static Electricity and PL	1-1
1-3 Precautions for the Safety	1-1
1-4 Others	1-1
2. Product Specifications	2-1
2-1 The Feature of Product	2-1
2-2 Product Specifications	2-2
2-3 Accessory	2-8
3. Disassembly and Reassembly	3-1
3-1 Indoor Unit	3-2
3-2 Outdoor Unit	3-14
4. Trouble shooting	4-1
4-1 Wired remote controller	4-1
4-2 Outdoor Trouble shooting	4-3
4-3 Troubleshooting by symptoms	4-5
4-3-1 Indoor temperature sensor (open/short)	4-5
4-3-2 Eva in and out sensor (open/short)	4-6
4-3-3 Float switch(Open)	4-7
4-3-4 Fan error	4-8
4-3-5 EEPROM error	4-9
4-3-6 Option error	4-10
4-3-7 Terminal Block's Terminal Fuse(Open)	4-11
4-3-8 Communication error after finishing tracking (E202)	4-12
4-3-9 Outdoor's service valve(Clog)	4-13
4-3-10 No Power(completely dead) - Initial diagnosis	4-14
4-3-11 E102 : Communication error between indoor and outdoor unit	
E201 : Unit quantity miss matching between Indoor and Outdoor	
E202 : Abnormal state, no communication between Indoor and Outdoor Main PCB	
E203 : 1min Time out of communication error(Main↔Inverter).....	4-18
4-3-12 External Sensor Error (Error Code: E221, E231, E251, E320)	4-19
4-3-13 E403 : Freezing control causes comp. down	4-20
4-3-14 E416 : Dischage temperature sensor error	4-21
4-3-15 E440, E441 : Abnormal outside temperature halts operation of the compressor ...	4-22
4-3-16 Outdoor unit BLDC Fan1 or Fan2 error (E458 : Fan1 error, E475 : Fan2 error)	4-23
4-3-17 E461: Compressor start error	
E467: Compressor wire missing error	4-24
4-3-18 E462 : Current protection control causes comp. down	
E484 : PFC overload error	4-25
4-3-19 E463 : OLP protection control caused comp. down	4-26
4-3-20 E464 : O.C. (Over Current) error	4-27
4-3-21 E466: DC Link Over voltage/ Low voltage error	4-28
4-3-22 Pipe Blocking Error (Error Code: E422)	4-29

Contents

4-3-23 The others	4-30
4-4 Setting Option Setup Method	4-31
4-5 Items to be checked first.....	4-37
5. PCB Diagram and Parts list	5-1
5-1 INDOOR UNIT	5-1
5-2 OUTDOOR UNIT	5-4
6. Wiring Diagram	6-1
6-1 Indoor Unit	6-1
6-2 Outdoor Unit	6-2
7. Reference Sheet	7-1
7-1 Refrigerating Cycle Diagram	7-1
7-2 Index for Model Name	7-2

1. Precautions

1-1 Precautions for the Service

- ▶ Use the standard parts when replacing the electric parts.
 - Confirm the model name, rated voltage, rated current of the electric parts.
- ▶ Repair the disconnection of HARNESS securely when repairing the break down.
 - If there is any connection error, it causes an abnormal noise and incorrect operation.
- ▶ In case that you assemble or disassemble the products with laying it on the side, do work on the work cloth.
 - If not, the exterior of products can be scratched.
- ▶ Remove dust and foreign materials from harness, connection part, and inspection part thoroughly when repairing the break down.
 - It protects the danger of fire such as tracking and short.
- ▶ Tighten tightly the service valve of outdoor unit and the cap of charging valve with a monkey spanner.
- ▶ Check the assembly status of parts after repairing the break down.
 - It should be same as the status before repairing.

1-2 Precautions for the Static Electricity and PL

- ▶ As the PCB power terminal has a weakness for the static electricity, pay attention to it during the repair and measurement.
 - Work with insulation gloves during the repair and measurement of PCB.
- ▶ Check the distance between the product and the other electronic appliances such as TV, video, and audio. It should be over 2m.
 - If not, it causes a bad picture quality or a noise.
- ▶ Repairing the products by consumer should be strictly prohibited.
 - There is a danger of electric shock or fire due to incorrect disassembly.

1-3 Precautions for the Safety

- ▶ Do not pull any electric wires and do not touch an auxiliary power switch with a wet hand.
 - There is a danger of electric shock or fire.
- ▶ In case any wire or power plug has been damaged, replace it to eliminate any possible danger.
- ▶ Do not bend the power cord by force and do not put any heavy object on the power cord.
 - There is a danger of electric shock or fire.
- ▶ Do not use multi socket.
 - There is a danger of electric shock or fire.
- ▶ Ground the product if necessary.
 - Be sure to ground the product if there is any danger of electric leakage due to water or moisture.
- ▶ Be sure to turn off the auxiliary power switch or pull out the power plug during replacement or repair of electric parts.
 - There is a danger of electric shock.
- ▶ In case the product will not be in use for a long time, the battery of remote control should be kept separately.
 - Leakage of inside fluid can cause break down of remote control.

1-4 Others

- ▶ Never store or load the air conditioner upside down or sideways to prevent the damage to the compressor.
- ▶ Young children or infirm persons should be always supervised when they use the air conditioner.
- ▶ Max current is measured according to IEC standard for safety.
- ▶ Current is measured according to ISO standard for energy efficiency.
- ▶ When installing, make sure there is no leakage. When recovering the refrigerant, ground the compressor first before removing the connection pipe. If the refrigerant pipe is not properly connected and the compressor works with the service valve open, the pipe inhales the air and it makes the pressure inside of the refrigerant cycle abnormally high. It may cause explosion and injury.
- ▶ Pump Down Procedure (When removing the product)
 - Turn on the air conditioner and select Cool mode to run the compressor for 3 minutes.
 - Release the valve caps on High and Low pressure side.
 - Use L wrench to close the valve on the high pressure side.
 - Approximately 2 minutes after, close the valve on the low pressure side.
 - Stop operation of the air conditioner.
 - Disconnect the pipes.

2. Product Specifications

2-1 The Feature of Product

- **Built-in Duct Type**
After installed, the air conditioner can be harmonized with a room interior.

- **High Performance & Energy Saving**
With the advanced BLDC inverter technology, it makes a room cool with highly energy saving and arises the efficiency of air conditioner.

- **Long Piping (Length & Height)**
It can give the benefit to the installers and arises the reliability of the air conditioner.

- **Long Ambient Operation (In Low Temperature)**
It can arise the reliability and the capacity of the air conditioner, especially operated in low temperature.

- **Eco-friendly Product (Lead-Free, RoHS, WEEE)**

2-2 Product Specification

ITEM			AC200JNHFKH AC200JXAFNH	
IMAGE	Indoor Unit			
	Outdoor Unit			
	Remote Controller		MWR-WE10N 	
Power	Product		3Φ, 380~415V/50Hz	
Indoor	W*D*H	mm	1350 x 910 x 450	
Outdoor	W*D*H	mm	880 x 765 x 1695	
Indoor	Product	kg(Net)	82.5	
Outdoor	Product	kg(Net)	190	
Capacity	Cooling/Heating(ISO)	W	20000/22500	
Power input	Cooling/Heating (ISO)	W	6060/6080	
Operation current	Cooling/Heating (ISO)	A	9.8/9.9	
Noise (Cooling/Heating)	Indoor unit	In case of strongest air blow	dB	52/52
	Outdoor unit	In case of strongest air blow	dB	68/68
Refrigerant (R410A)		g	8000 (Charged for 30m)	
Connecting Pipe	Liquid	mm	9.52	
	Gas	mm	19.05	
Additional Refrigerant (R410A)		g/m	60	
Standard		m	7.5	
Extension length(Total)		m	150	
Extension length(Elevation)		m	50	
Option Code		Product Option	012474-1C50C0-20C8E1-320000	
		Installation Option	020000-100000-200000-300000 030000-100000-200000-300000	

ITEM			AC180JNHFKH AC180JXAFNH	
IMAGE	Indoor Unit			
	Outdoor Unit			
	Remote Controller		MWR-WE10N 	
Power	Product		3Φ, 380~415V/50Hz	
Indoor	W*D*H	mm	1350 x 910 x 450	
Outdoor	W*D*H	mm	940 x 330 x 1420	
Indoor	Product	kg(Net)	82.5	
Outdoor	Product	kg(Net)	97	
Capacity	Cooling/Heating(ISO)	W	18000/20000	
Power input	Cooling/Heating (ISO)	W	5290/5410	
Operation current	Cooling/Heating (ISO)	A	8.1/8.4	
Noise (Cooling/Heating)	Indoor unit	In case of strongest air blow	dB	51/51
	Outdoor unit	In case of strongest air blow	dB	63/65
Refrigerant (R410A)		g	4600 (Charged for 30m)	
Connecting Pipe		Liquid	mm	9.52
		Gas	mm	19.05
Additional Refrigerant (R410A)		g/m	50	
Standard		m	5	
Extension length(Total)		m	75	
Extension length(Elevation)		m	30	
Option Code		Product Option	01107C-1C50B0-27B414-370060	
		Installation Option	020000-100000-200000-300000 030000-100000-2463E3-3B4402	









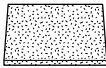
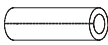
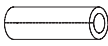
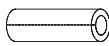

ITEM			AC160JNHFKH AC160JXAFNH	
IMAGE	Indoor Unit			
	Outdoor Unit			
	Remote Controller		MWR-WE10N 	
Power	Product		3Φ, 380~415V/50Hz	
Indoor	W*D*H	mm	1350 x 910 x 450	
Outdoor	W*D*H	mm	940 x 330 x 1420	
Indoor	Product	kg(Net)	78.5	
Outdoor	Product	kg(Net)	95	
Capacity	Cooling/Heating(ISO)	W	16000/18000	
Power input	Cooling/Heating (ISO)	W	4710/4860	
Operation current	Cooling/Heating (ISO)	A	7.4/7.6	
Noise (Cooling/Heating)	Indoor unit	In case of strongest air blow	dB	50/50
	Outdoor unit	In case of strongest air blow	dB	62/64
Refrigerant (R410A)		g	3500 (Charged for 30m)	
Connecting Pipe		Liquid	mm	9.52
		Gas	mm	15.88
Additional Refrigerant (R410A)		g/m	50	
Standard		m	5	
Extension length(Total)		m	75	
Extension length(Elevation)		m	30	
Option Code		Product Option	01107C-1C50A0-27A0B4-370060	
		Installation Option	020000-100000-200000-300000 034338-103D48-243383-3D4802	

ITEM			AC160JNHFKH AC160JXAFKH	
IMAGE	Indoor Unit			
	Outdoor Unit			
	Remote Controller		MWR-WE10N 	
Power	Product		1Φ, 220~240V/50Hz	
Indoor	W*D*H	mm	1350 x 910 x 450	
Outdoor	W*D*H	mm	940 x 330 x 1420	
Indoor	Product	kg(Net)	78.5	
Outdoor	Product	kg(Net)	95	
Capacity	Cooling/Heating(ISO)	W	16000/18000	
Power input	Cooling/Heating (ISO)	W	4710/5860	
Operation current	Cooling/Heating (ISO)	A	21/21	
Noise (Cooling/Heating)	Indoor unit	In case of strongest air blow	dB	50/50
	Outdoor unit	In case of strongest air blow	dB	62/64
Refrigerant (R410A)		g	3500 (Charged for 30m)	
Connecting Pipe		Liquid	mm	9.52
		Gas	mm	15.88
Additional Refrigerant (R410A)		g/m	50	
Standard		m	5	
Extension length(Total)		m	75	
Extension length(Elevation)		m	30	
Option Code		Product Option	01107C-1C50A0-27A0B4-370060	
		Installation Option	020000-100000-200000-300000 034338-103D48-243383-3D4802	

ITEM			AC180JNHPKH AC180JXAPNH	
IMAGE	Indoor Unit			
	Outdoor Unit			
	Remote Controller		MWR-WE10N 	
Power	Product		3Φ, 380~415V/50Hz	
Indoor	W*D*H	mm	1350 x 910 x 450	
Outdoor	W*D*H	mm	940 x 330 x 1420	
Indoor	Product	kg(Net)	82.5	
Outdoor	Product	kg(Net)	107.5	
Capacity	Cooling/Heating(ISO)	W	18000/20000	
Power input	Cooling/Heating (ISO)	W	5450/5540	
Operation current	Cooling/Heating (ISO)	A	8.4/8.6	
Noise (Cooling/Heating)	Indoor unit	In case of strongest air blow	dB	51/51
	Outdoor unit	In case of strongest air blow	dB	63/65
Refrigerant (R410A)		g	4600 (Charged for 30m)	
Connecting Pipe		Liquid	mm	9.52
		Gas	mm	19.05
Additional Refrigerant (R410A)		g/m	50	
Standard		m	5	
Extension length(Total)		m	75	
Extension length(Elevation)		m	30	
Option Code		Product Option	01107C-1C50B0-27B414-370060	
		Installation Option	020000-100000-200000-300000 030000-100000-2463E3-3B4402	



ITEM			AC200JNHPKH AC200JXAPKH	
IMAGE	Indoor Unit			
	Outdoor Unit			
	Remote Controller		MWR-WE10N 	
Power	Product		3Φ, 380~415V/50Hz	
Indoor	W*D*H	mm	1350 x 910 x 450	
Outdoor	W*D*H	mm	880 x 765 x 1695	
Indoor	Product	kg(Net)	82.5	
Outdoor	Product	kg(Net)	190	
Capacity	Cooling/Heating(ISO)	W	20000/22000	
Power input	Cooling/Heating (ISO)	W	6230/6090	
Operation current	Cooling/Heating (ISO)	A	10.8/10.0	
Noise (Cooling/Heating)	Indoor unit	In case of strongest air blow	dB	52/52
	Outdoor unit	In case of strongest air blow	dB	68/68
Refrigerant (R410A)		g	8000 (Charged for 30m)	
Connecting Pipe		Liquid	mm	9.52
		Gas	mm	19.05
Additional Refrigerant (R410A)		g/m	60	
Standard		m	7.5	
Extension length(Total)		m	150	
Extension length(Elevation)		m	50	
Option Code		Product Option	012474-1C50C0-20C8DC-320000	
		Installation Option	020000-100000-200000-300000 030000-100000-200000-300000 050000-100000-200000-300000	

2-3 Accessory

Item	Descriptions	Code-No.	Q'TY	Remark
	Owner's Manual	DB68-04089A(C/O) DB68-04657A(H/P)	1	Indoor Unit
	INSTALLATION MANUAL	DB68-05127A	1	
	Insulation	DB62-04318S	1	
	Insu DRAIN HOSE	DB62-11028A	1	
	INSU HOSE D	DB62-11028E	1	
	INSU TUBE OUT	DB62-11028F	1	
	ASSY DRAIN HOSE JOINT	DB67-01191A	1	
	Ass'y Drain Hose Joint	DB90-06701A	1	
	GROMMET-HANGER	DB63-00237A	8	
	RUBBER LEG	DB73-20134A	4	
	INSTALLATION MANUAL	DB68-05128A	1	
	DRAIN PLUG	DB67-00477A (H/P)	1	
	RUBBER LEG	DB73-20134A	4	

3. Disassembly and Reassembly

■ Necessary Tools

Item	Remark
+SCREW DRIVER	
MONKEY SPANNER	

3-1 Indoor Unit

■ AC160JNHFKH/AC180JNHFKH/AC200JNHFKH/AC180JNHPKH/AC200JNHPKH



No	Parts	Procedure	Remark
1	Commom	1)Disasseble the Cover Control. - Unscrew 2 screws ⚠ You must turn off the Power before disassembly.	

► service from Top side

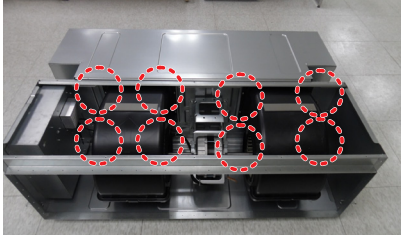
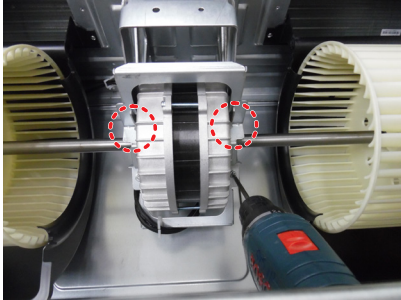
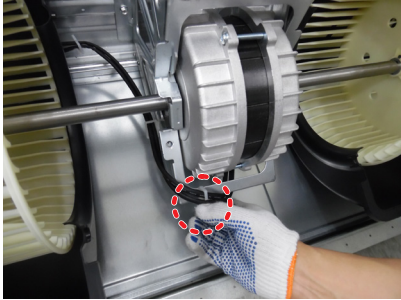
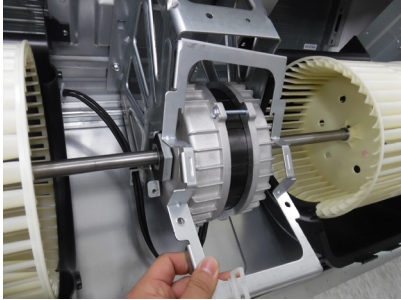
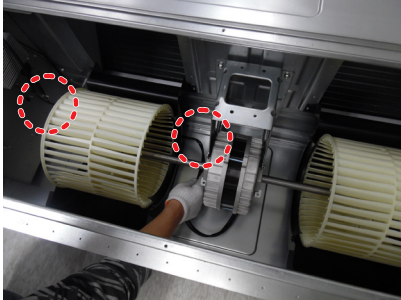

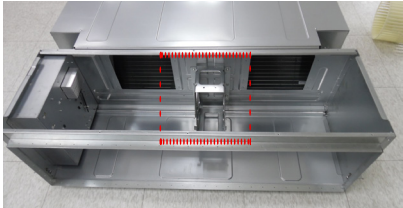

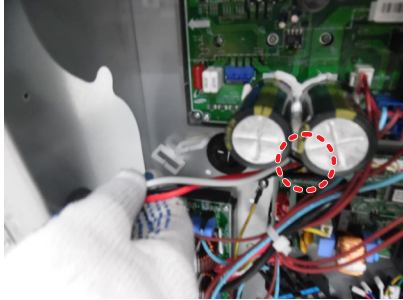
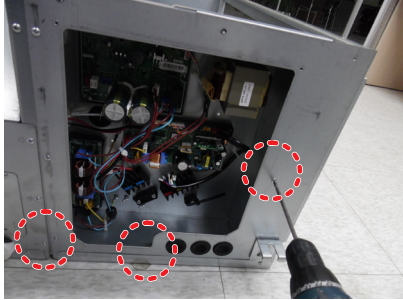
No	Parts	Procedure	Remark
2	Motor & Fan	<p>1) Disassemble the connection wire to take the motor fan out</p> <p>2) Disassemble th Cabinet Top Fan. - Unscrew 6 screws</p> <p>3) Disassemble the Link Screw - Unscrew 3 screws</p> <p>4) Disassemble Cabinet Top Fan.</p>	    

No	Parts	Procedure	Remark
		<p>5) Disassemble 2 Case Blower Top. - Unscrew 8 screws</p> <p>6) Disassemble 1 Holder Motor. - Unscrew 2 screws</p> <p>7) Disassemble Motor wire from 2 holder wire</p>	    

No	Parts	Procedure	Remark
		<p>8) After disassemble the Motor and Blower for the set, disassemble the Blower by use of 3mm wrench.</p> <p>9)Disassemble 2 Case blower bottom. - Unscrew 4 screws</p> <p>10)Disassemble the Bracket Motor. - Unscrew 4 screws</p>	   

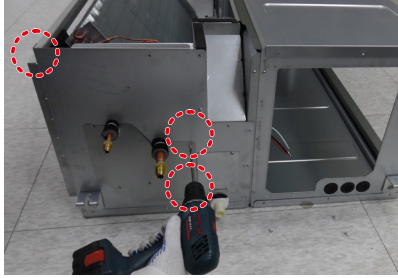
No	Parts	Procedure	Remark
3	Control Box	<p>1)Disassemble Evap Sensor wire and EEV wire(20kW only)</p> <p>2) Disassemble the Case Control. - Unscrew 3 screws</p>	  

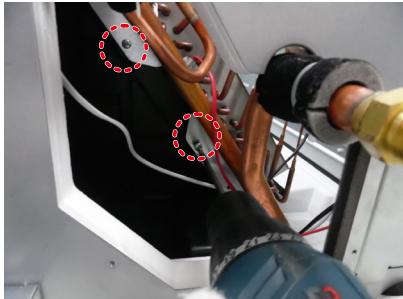

No	Parts	Procedure	Remark
4	Evap	<p>1)Disassemble The Case Evap Top - [AC***JNHFKH]Unscrew 8 screws - [AC***JNHPKH]Unscrew 6 screws</p> <p>2)Disassemble The Cushion Front.</p> <p>3)Disassemble The Cushion Support. - Unscrew 1 screw</p>	



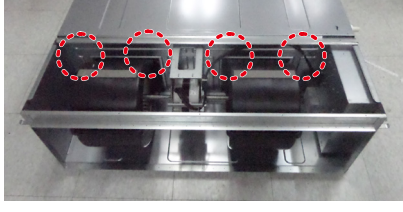

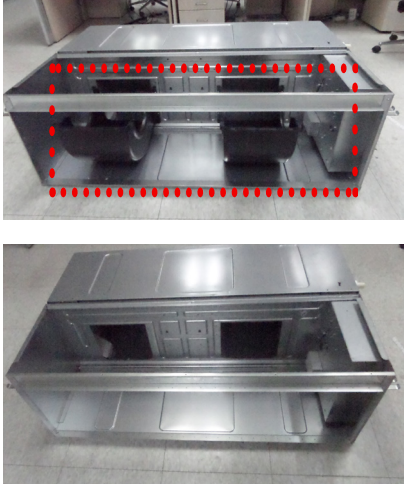
No	Parts	Procedure	Remark
		<p>4)Disassemble The Cover pipe. - Unscrew 3 screws</p> <p>5)Remove The cable tie on the Support Evap</p> <p>6)Disassemble The Evap. - Unscrew 4 screws</p>	    

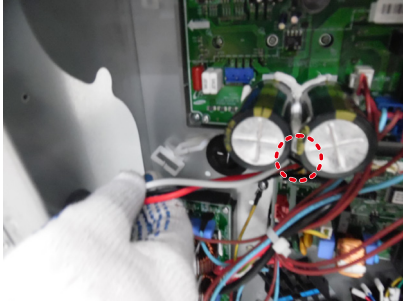
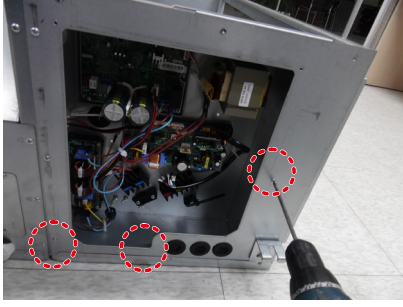
► service from Bottom side

No	Parts	Procedure	Remark
1	Motor & Fan	<p>1)Disassembl the connection wire to take the motor fan out</p> <p>2) Diassemble The Cabi Fan Bottom. - Unscrew 9 screws</p> <p>3) Disassemble the Link Screw - Unscrew 3 screws</p> <p>4)Disassemble 2 Case blower bottom. - Unscrew 4 screws</p> <p>5)Disassemble Bracket Motor and Motor. - Unscrew 4 screws</p> <p>6)After disassemble the Motor and Blower for the set, disassemble the Blower by use of 3mm wrench.</p>	      

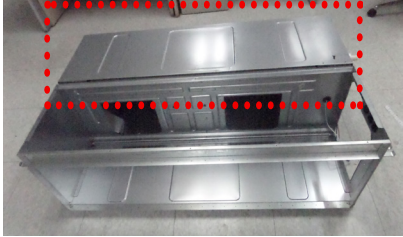
No	Parts	Procedure	Remark
		<p>7)Disassemble The Case Blower Top. - Unscrew 8 screws</p>	

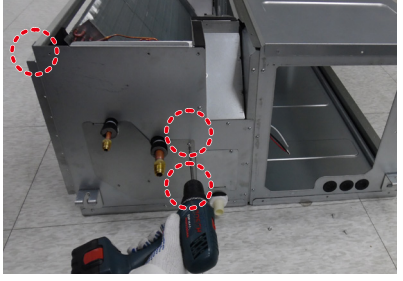
No	Parts	Procedure	Remark
2	Control Box	<p>1) Disassemble Evap Sensor wire and EEV wire (20kW only)</p> <p>2) Disassemble the Case Control. - Unscrew 3 screws</p>	  

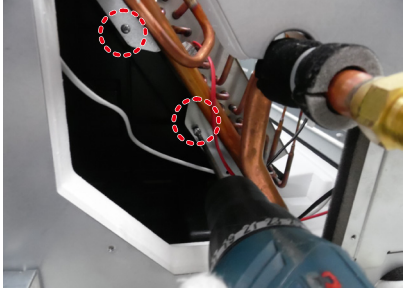

No	Parts	Procedure	Remark
3	Evap	<p>1)Disassemble The Case Evap Bottom - [AC***JNHFKH]Unscrew 11 screws - [AC***JNHPKH]Unscrew 7 screws</p> <p>2)Disassemble The Drain Pan</p> <p>3)Disassemble The Cover pipe. - Unscrew 3 screws</p> <p>4)Remove The cable tie on the Support Evap</p> <p>5)Disassemble The Support Evap. - Unscrew 2 screws</p>	    

No	Parts	Procedure	Remark
		<p>6) Disassemble The Evap. - Unscrew 2 screws</p> <p>① Moving the Evap 2~5cm to pipe direction ② Holding the pipe side and then rotating the opposite side ③ Moving the Evap in the direction of the arrow 3</p>	

3-2 Outdoor Unit

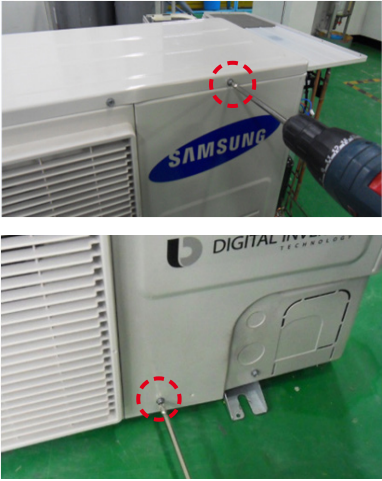
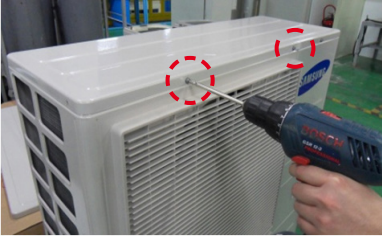
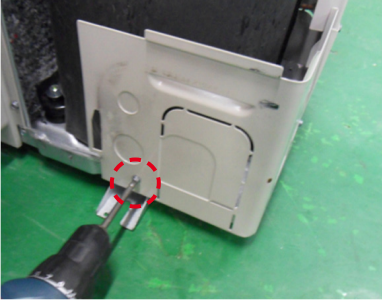
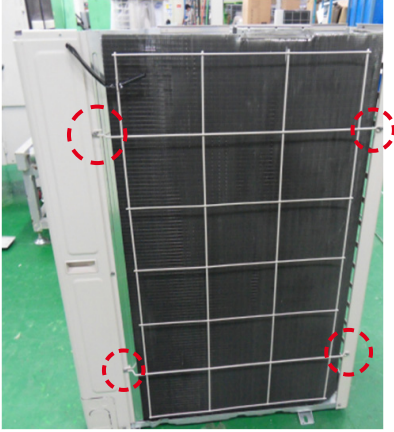
■ AC160JXAFKH/AC160JXAFNH/AC180JXAFNH/AC180JXAPNH

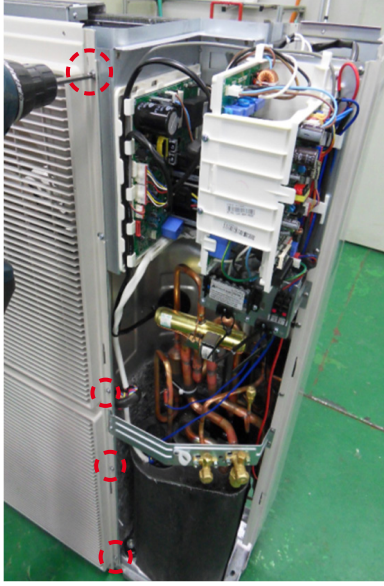
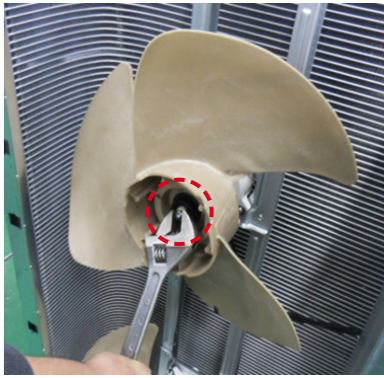

No	Parts	Procedure	Remark
1	Cabi Front RH	<p>⚠ You must turn off the Power before disassembly.</p> <p>1) Unscrew and remove two mounting screw in the Cabinet Front RH. (Use +Screw Driver)</p>	
2	Cabi Top	<p>1) Unscrew and remove 9 screws on each side of the Cabinet-Top. (Use +Screw Driver)</p>	
3	Cabi Install Front	<p>1) Unscrew and remove 1 screw in the Cabinet-Install Front. (Use +Screw Driver)</p>	
4	Guard Cond	<p>1) Pull the sensor from Guard Cond.</p> <p>2) Unscrew and remove 4 screws in the Guard Cond. (Use +Screw Driver)</p>	

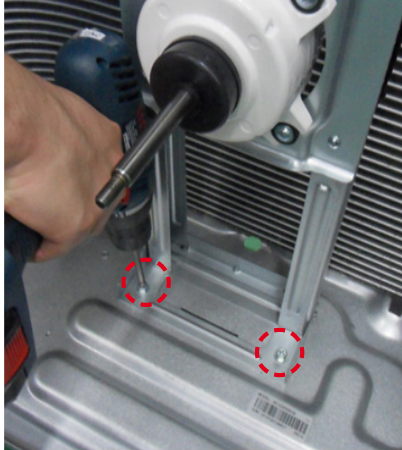
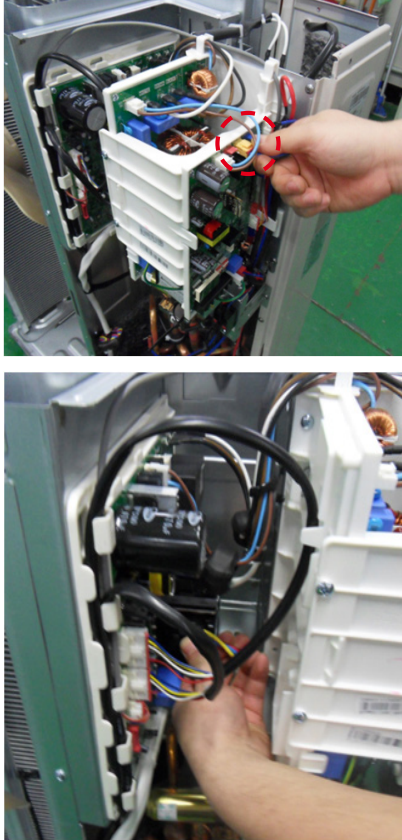
No	Parts	Procedure	Remark
5	Cabi Back RH	1) Pull the sensor from Cabi Back RH. 2) Unscrew and remove 4 screws on each side of the Cabinet Back RH. (Use +Screw Driver)	
6	Cabi Install Back	1) Unscrew and remove 1 screw in the Cabinet-Install Back. (Use +Screw Driver)	
7	Cabi Front LF	1) Unscrew and remove 10 screws in the Cabinet-Front LF. (Use +Screw Driver)	
8	Fan	1) Turn 2 mounting nuts as shown in the picture and remove it. (Use Adjustable Wrench)	

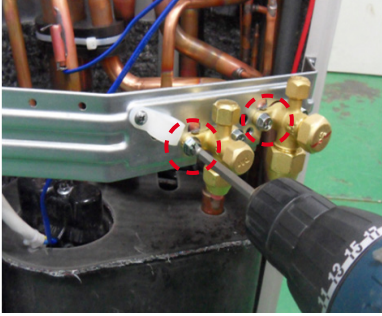
No	Parts	Procedure	Remark
9	Motor	1) Separate the Fan Propeller. 2) Unscrew and remove the 8 Motor mounting screws. (Use +Screw Driver) 3) Disconnect the Motor wire From Ass'y Control Out.	
10	Bracket Motor	1) Unscrew and remove 2 mounting screws in Bracket Motor. (Use +Screw Driver)	
11	Control Out	1) Disconnect 4 Connecters From Ass'y Control Out. 2) Unscrew and remove 1 mounting screw in Control Out. (Use +Screw Driver) 3) Separate Ass'y Control Out.	

No	Parts	Procedure	Remark
12	Assy 4way Valve	<p>1) Purge the Coolant first.</p> <p>2) Unscrew and remove 2 mounting screws in Service Valve. (Use +Screw Driver)</p> <p>3) Separate the pipe from the Entrance/Exit using a welder.</p> <p>▲ When removing the compressor, Heat Exchanger, and Pipe, purge the Coolant inside the Compressor completely and remove the pipe with a welding flame.</p>	
13	Assy EEV Valve	<p>1) Unscrew and remove 2 mounting screws in Service Valve. (Use +Screw Driver)</p> <p>2) Separate the pipe from the Entrance/Exit using a welder.</p>	

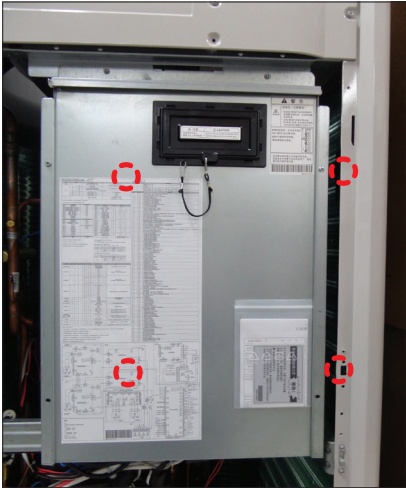
■ AC200JXAFNH/AC200JXAPNH

No.	Parts	Procedure	Remark
1	Electrical equipment Part	<p>1) 14 screws that is fixing CABINET remove.(Use + Screw driver)</p> <p>2) Remove 4 screws that is fixing and separate Cover Control Box. (Use + Screw driver)</p> <p>3) Power, Compressor, Valve, Motor, Sensor connector connected to ASSY PCB remove.</p>	  

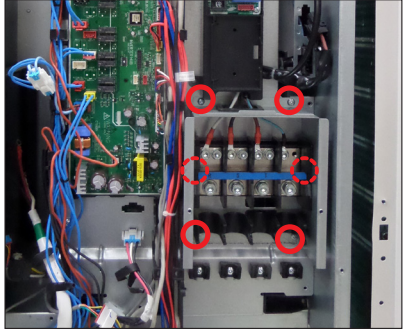
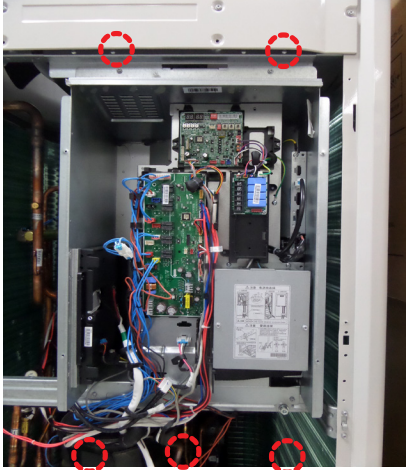
No.	Parts	Procedure	Remark
		<p>4) 2 screws had fixed in terminal block cover when change power terminal block, communication terminal block remove.</p>	
		<p>5) 2 screws had fixed in terminal block after remove 4 screws had fixed to Cabinet for terminal block protection remove.</p>	
		<p>6) 5 screws had fixed to Front part remove.</p>	

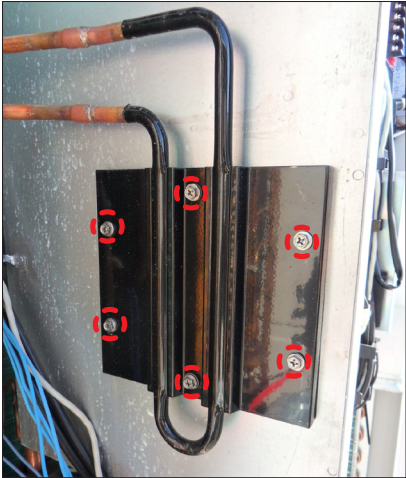
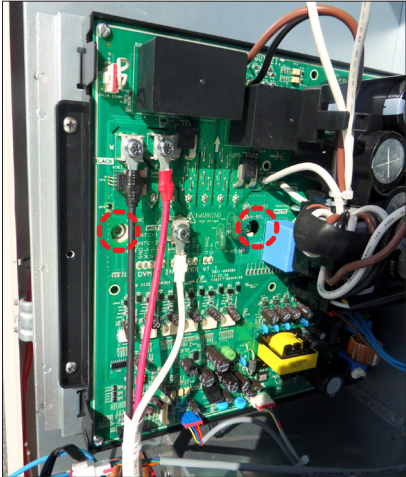
No.	Parts	Procedure	Remark
		<p>7) 6 screws had fixed on side refrigerant cooling part outside remove .</p> <p>⚠ Do not separate Heat Sink pulling Assy Piping Cooling piping compulsorily. (Is responsible for parts damage.)</p> <p>8) 2 screws had fixed on side refrigerant cooling part inside remove.</p>	 

4. Troubleshooting

4-1 Wired remote controller

- ◆ If an error occurs,  is displayed on the wired remote controller.
If you would like to see an error code, press the Test button.

Error mode	Contents	Error type
808	Indoor unit communication error	Communication error
808	Duplicated address setting error	Communication error
809	No response error address from indoor unit	Communication error
821	Indoor temperature sensor (open/short error)	Indoor sensor error
822	Indoor unit Eva In sensor (Open/Short)	Indoor sensor error
853	Indoor floating switch secondary detection	Self diagnostic error
202	Indoor/outdoor communication error (1 min)	Communication error
203	Communication error between indoor/outdoor INV↔MAIN MICOM (1 min)	Communication error
221	Outdoor temperature sensor error	Outdoor sensor error
231	COND temperature sensor error	Outdoor sensor error
251	[Inverter] Emission temperature sensor error	Outdoor sensor error
403	Detection of Indoor Freezing (when Comp. Stops)	Outdoor unit protection control error
404	Protection of Outdoor Overload (when Comp. Stops)	Outdoor unit protection control error
406	Emission temperature excessively high	Outdoor unit protection control error
422	High pressure blockage error (Refrigerant completely Leakage error)	Self diagnostic error
440	Heating operation blocked	Self diagnostic error
441	Cooling operation blocked	Self diagnostic error
458	Outdoor fan 1 error	Self diagnostic error
461	[Inverter] Compressor startup error	Outdoor unit protection control error
462	[Inverter] Total current error/PFC over current error	Outdoor unit protection control error

Error mode	Contents	Error type
463	OLP Overheat and Comp. Stop	Outdoor unit protection control error
464	[Inverter] IPM over current error	Outdoor unit protection control error
465	Compressor V limit error	Outdoor unit protection control error
466	DC LINK over/low voltage error	Outdoor unit protection control error
467	[Inverter] Compressor rotation error	Outdoor unit protection control error
468	[Inverter] Current sensor error	Outdoor unit protection control error
469	[Inverter] DC LINK voltage sensor error	Outdoor unit protection control error
470	EEPROM Read/Write error	Outdoor unit protection control error
471	[Inverter] OTP error	Outdoor unit protection control error
472	AC ZERO CROSSING SIGNAL OUT error	Outdoor unit protection control error
473	Compressor LOCK error	Outdoor unit protection control error
475	Outdoor fan 2 error	Self diagnostic error
500	IPM Overheat Error for Outdoor Unit Inverter Comp.	Outdoor unit protection control error
554	Gas leak error	Self diagnostic error
556	Capacities not matched	Outdoor unit protection control error
601	Communication error between the indoor unit and wired remote controller	Wired remote controller error
602	Communication error between the Master and Slave wired remote controllers	Wired remote controller error

4-2 Outdoor Trouble shooting

The table below give indication about self diagnostic routine. Some of error code requires activities exclusively for Authorized Service Center.

Outdoor unit

If an error occurs during the operation, it is displayed on the outdoor unit PCB LED, both MAIN PCB and INVERTER PCB.

No.	Displayed PCB Assy	Meaning	Remarks	Error Code	Remark
-	MAIN/INVERTER	Normal operation (MAIN : Indoor↔Outdoor : Green ON) (INVERTER : MAIN PCB↔INVERTER PCB : Green ON)		-	4-3-10
1	MAIN	Unit quantity miss matching between indoor and outdoor.	Check indoor quantity setting in outdoor	E201	4-3-11
2	MAIN/INVERTER	Abnormal state, no communication between Indoor and Outdoor Main PCB	Check electrical connection and setting	E202	
3	MAIN/INVERTER	1min. Time out of communication error(Main↔Inverter)	Check electrical connection and setting	E203	
4	MAIN	Outdoor temp sensor error	Check Outdoor sensor Open/Short	E221	4-3-12
5	MAIN	Cond. temp sensor error	Check Cond. sensor Open/Short	E231	
6	MAIN	Discharge temp sensor error	Check Discharge sensor Open/Short	E251	
7	MAIN	OLP Sensor Error	Check OLP sensor Open/Short	E320	
8	MAIN	Detection of Outdoor Freezing when Comp. Stop	Check Outdoor Cond.	E403	4-3-13
9	MAIN	Protection of Outdoor Overload when Comp. Stop	Check Comp. when it start	E404	4-3-23
10	MAIN	Discharge temperature of a compressor in an outdoor unit is overheated.		E416	4-3-14
11	MAIN	Heating operation is not available since the outdoor air temperature is over 30°C.	Heating	E440	4-2-15
		Cooling operation is not available since the outdoor air temperature is lower than -15°C.	Cooling	E441	
12	MAIN/INVERTER	Outdoor unit BLDC Fan 1 or Fan 2 error	FAN1 error	E458	4-3-16
			FAN2 error	E475	
13	MAIN/INVERTER	Comp. Starting error		E461	4-3-17
14	MAIN	Primary Current Trip error		E462	4-3-18
15	MAIN	Over current trip / PFC over current error	Check OLP sensor	E463	4-3-19
16	MAIN/INVERTER	IPM(IGBT Module) Over Current(O.C)		E464	4-3-20
17	MAIN/INVERTER	Comp. Over load error		E465	4-3-23
18	MAIN/INVERTER	DC-Link voltage under/over error	Check AC Power or DC_Link voltage	E466	4-3-21
19	MAIN/INVERTER	Comp. wire missing error	Check Comp. wire	E467	4-3-17
20	MAIN/INVERTER	Current sensor error	Check Outdoor Inverter PBA	E468	4-3-23
21	MAIN	Outdoor EEPROM error	Check Outdoor EEPROM data	E471	
22	MAIN/INVERTER	IPM(IGBT Module) or PFCM Temperature sensor Error	Check Outdoor Inverter PBA	E474	
23	MAIN/INVERTER	PFC Overload Error	Check Outdoor Inverter PBA	E484	4-3-18

No.	Displayed PCB Assy	Meaning	Remarks	Error Code	Remark
24	MAIN/INVERTER	IPM is over heated.	Check Outdoor Inverter PBA	E500	4-3-23
25	MAIN	GAS Leak error	Check indoor and outdoor unit model	E554	
26	MAIN	Capacity miss match between indoor and outdoor	Check indoor and outdoor unit model	E556	
30	MAIN	EEV or Valve Close error-Self diagnosis	<ol style="list-style-type: none"> 1. Check for refrigerant leakage (pipe connections, heat Exchanger) and charge refrigerant if necessary 2. Check if there's any blockage on refrigerant cycle (indoor unit/outdoor unit) 3. Check if additional refrigerant has been added after pipe extension 	E422	4-3-22
32	MAIN	Error of Terminal Block's Thermal Fuse(Open)		E198	4-3-7

4-3 Troubleshooting by symptoms

4-3-1 Indoor temperature sensor (open/short)

Wire remote controller display	E121
Symptom	Error of Room sensor in the indoor unit(Open/Short)
Failure	Short or leakage of the Room sensor

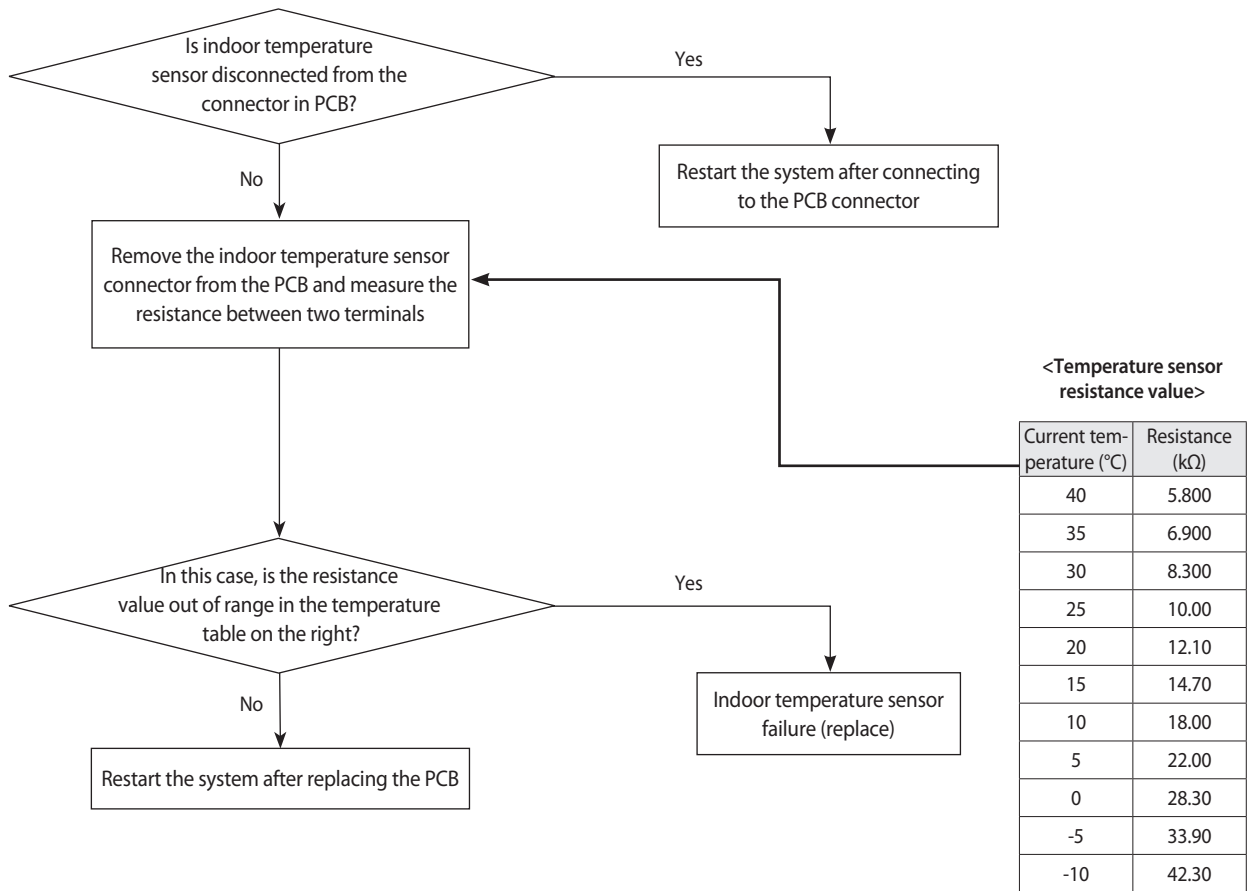

4-3-2 Eva in and out sensor (open/short)

Wire remote controller display	E122, E123
Symptom	Error of EVA-IN, EVA-OUT sensor in the indoor unit (Open/Short)
Failure	Short or leakage of the EVA sensor

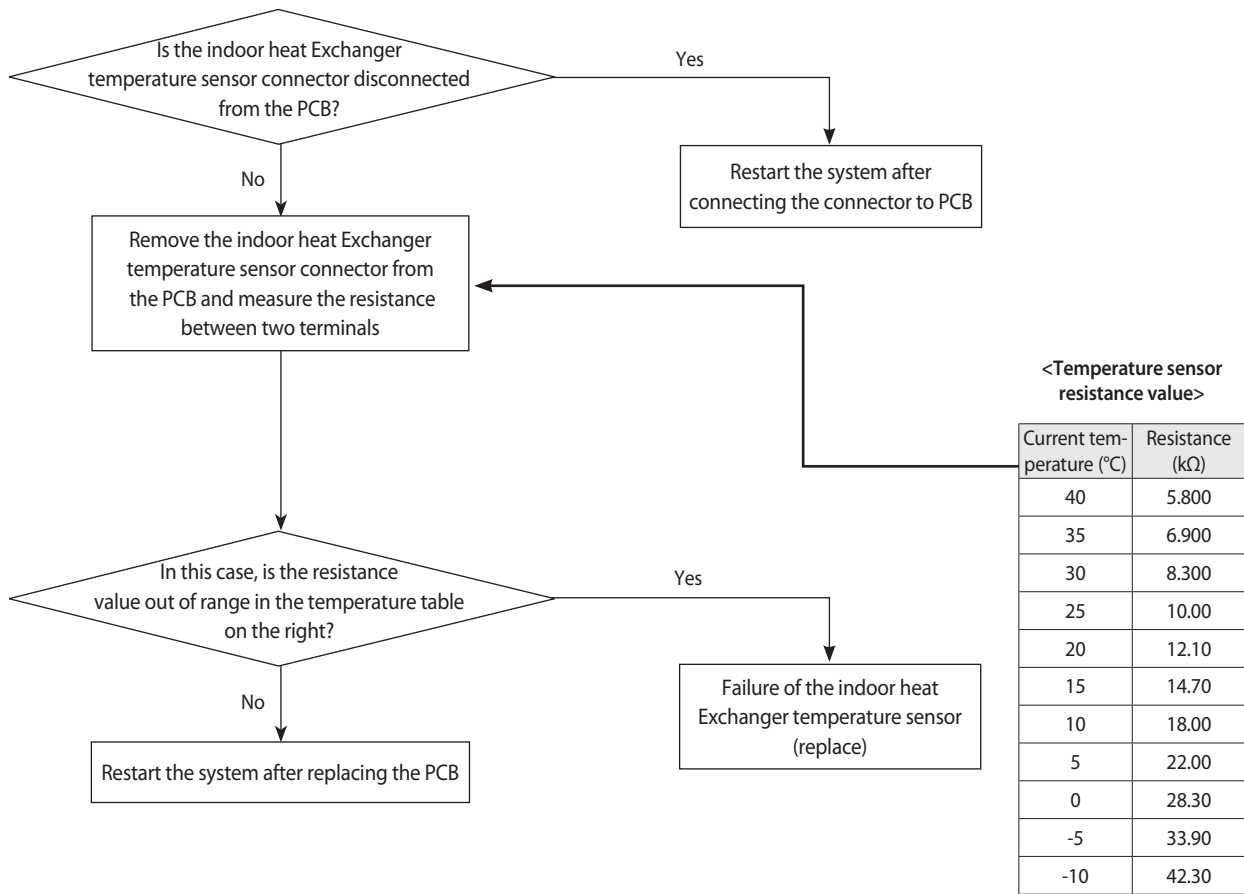

4-3-3 Float switch(Open)

Wire remote controller display	E153
Symptom	2nd Detection of the float switch
Failure	Float switch open

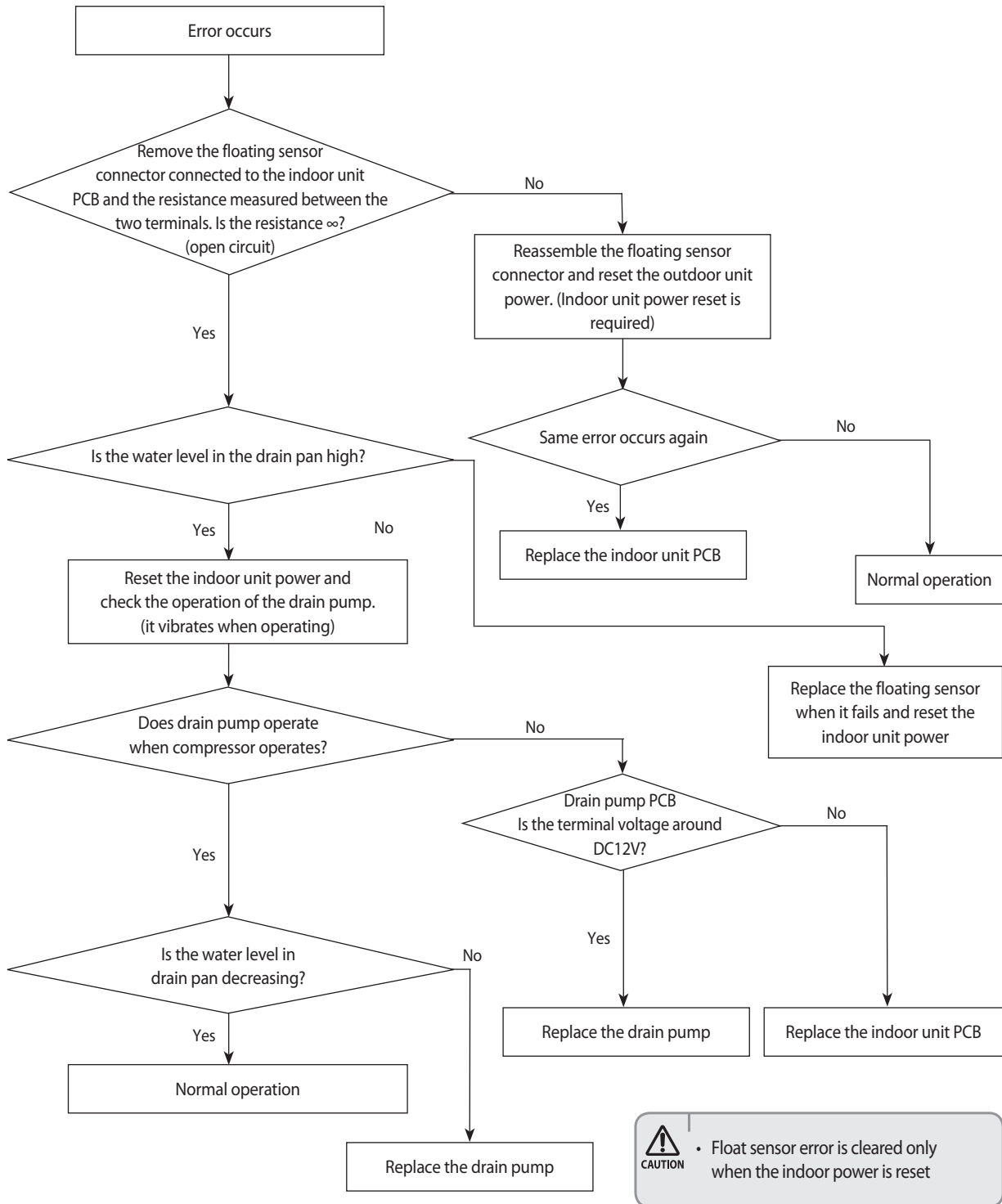

4-3-4 Fan error

Wire remote controller display	E154
Symptom	Error of Fan motor in the indoor unit
Failure	Fan error

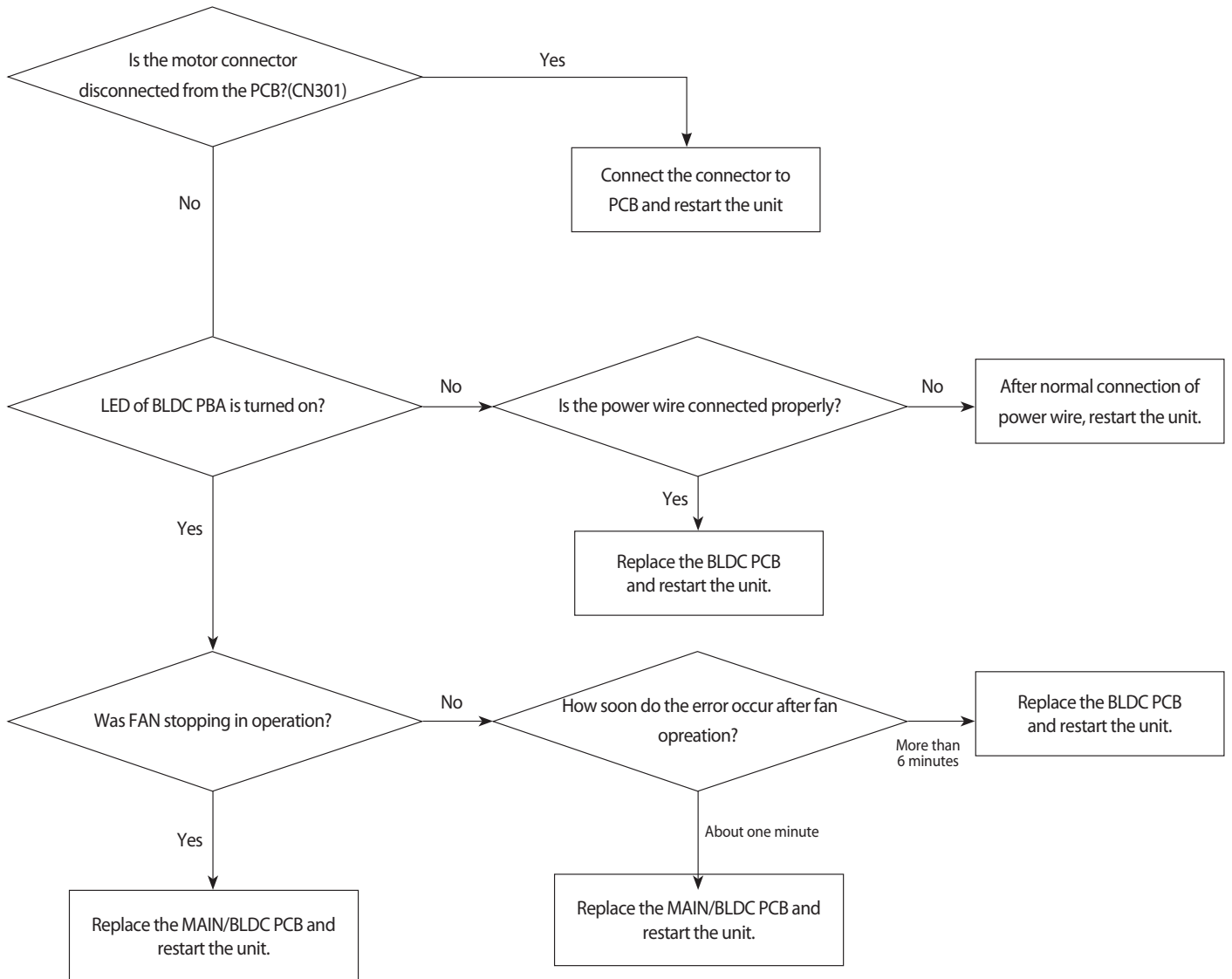

4-3-5 EEPROM error

Wire remote controller display	E162
Symptom	EEPROM PCB disconnected from the MAIN PCB
Failure	Option error

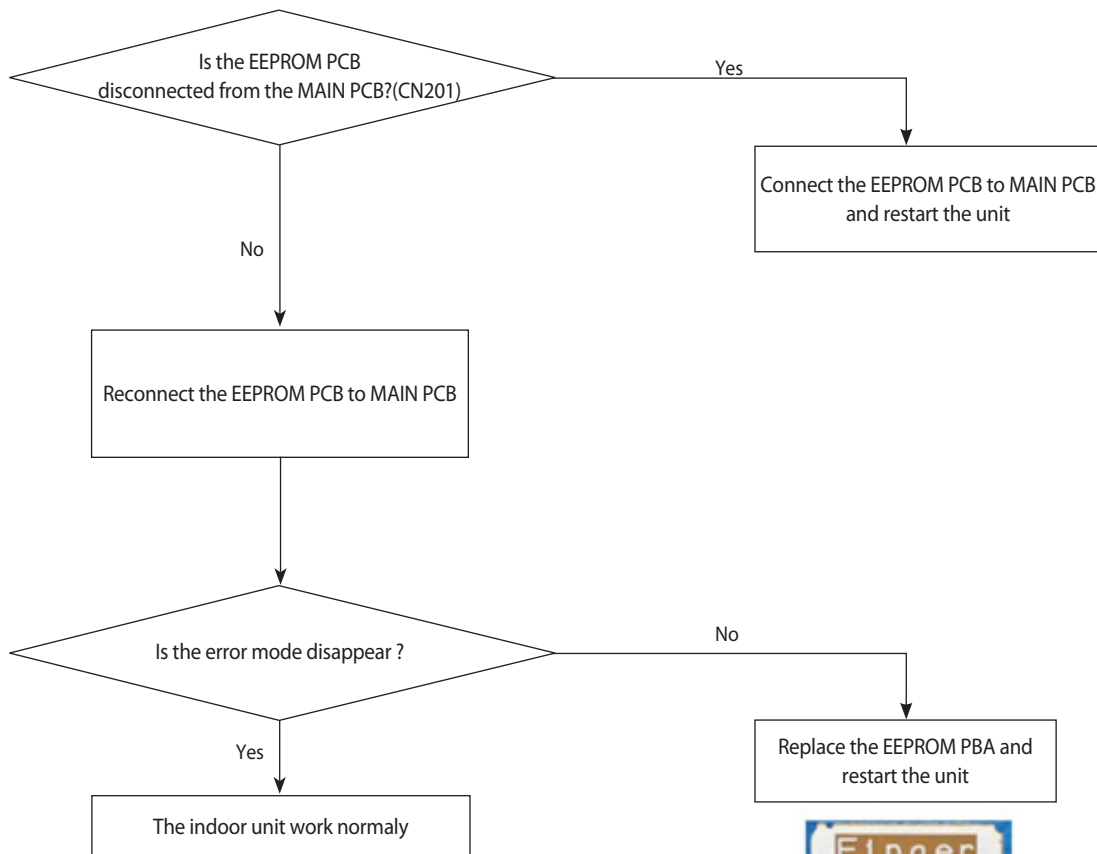

4-3-6 Option error

Wire remote controller display	E163
Symptom	EEPROM option setting error
Failure	Option error

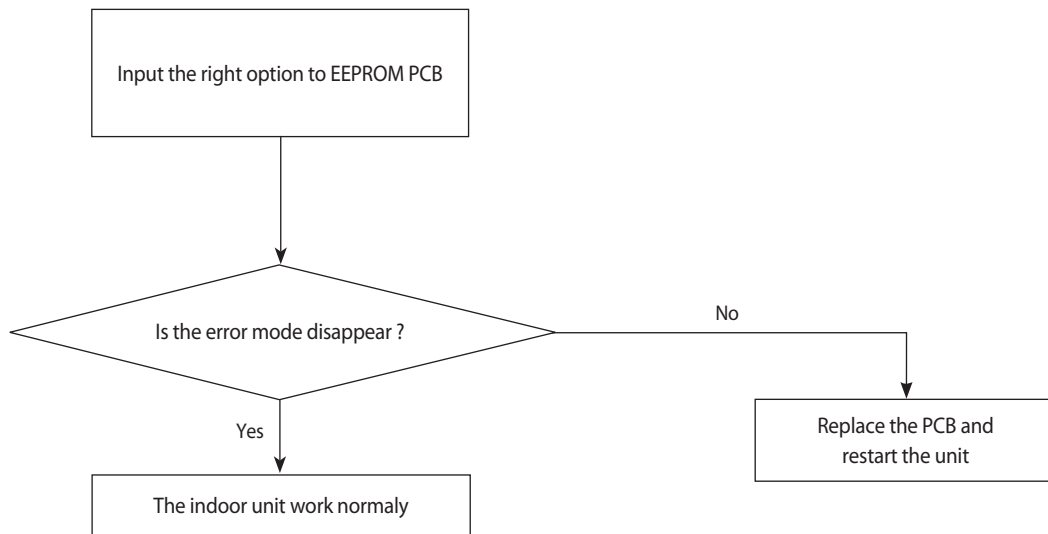

4-3-7 Terminal Block's Terminal Fuse(Open)

Wire remote controller display	E198
Symptom	Error of Terminal Block's Terminal Fuse(Open)
Failure	Fuse open

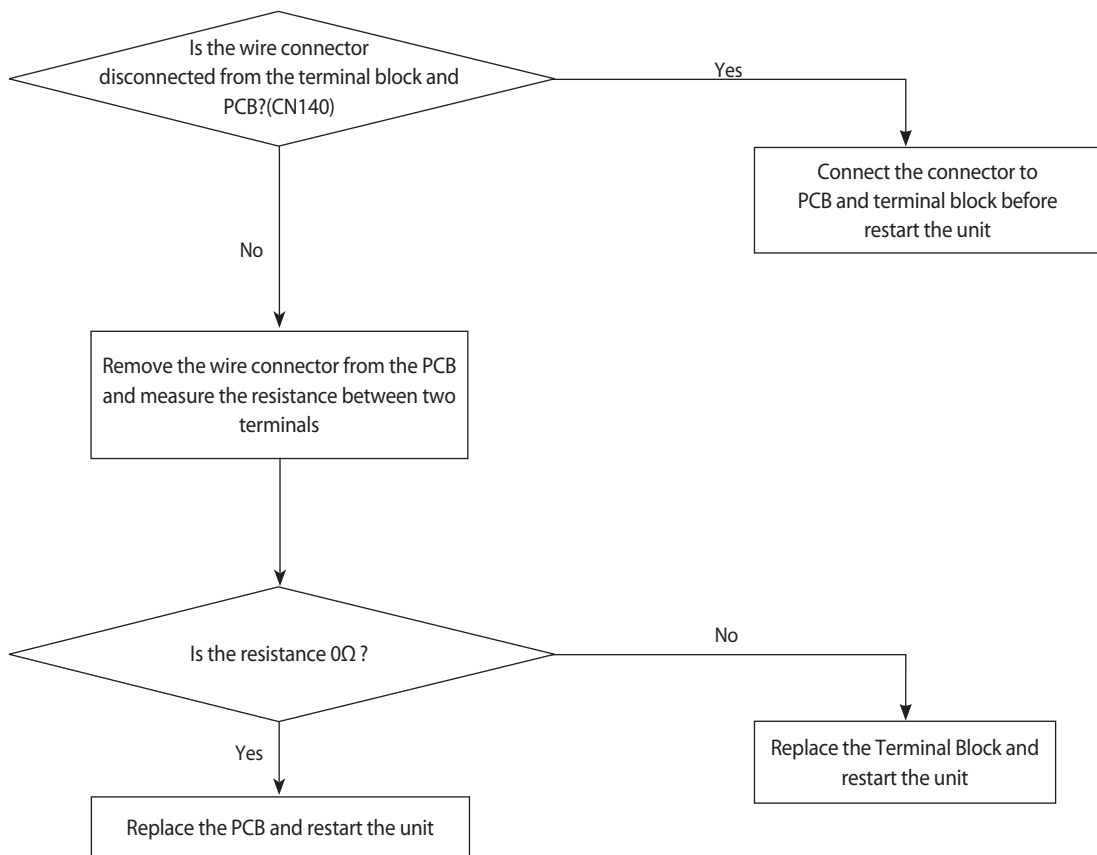

4-3-8 Communication error after finishing tracking (E202)

1. Check items
 - 1) Is the communication cable short/open?
 - 2) Is there a response from the indoor unit PCB?
2. Check procedure

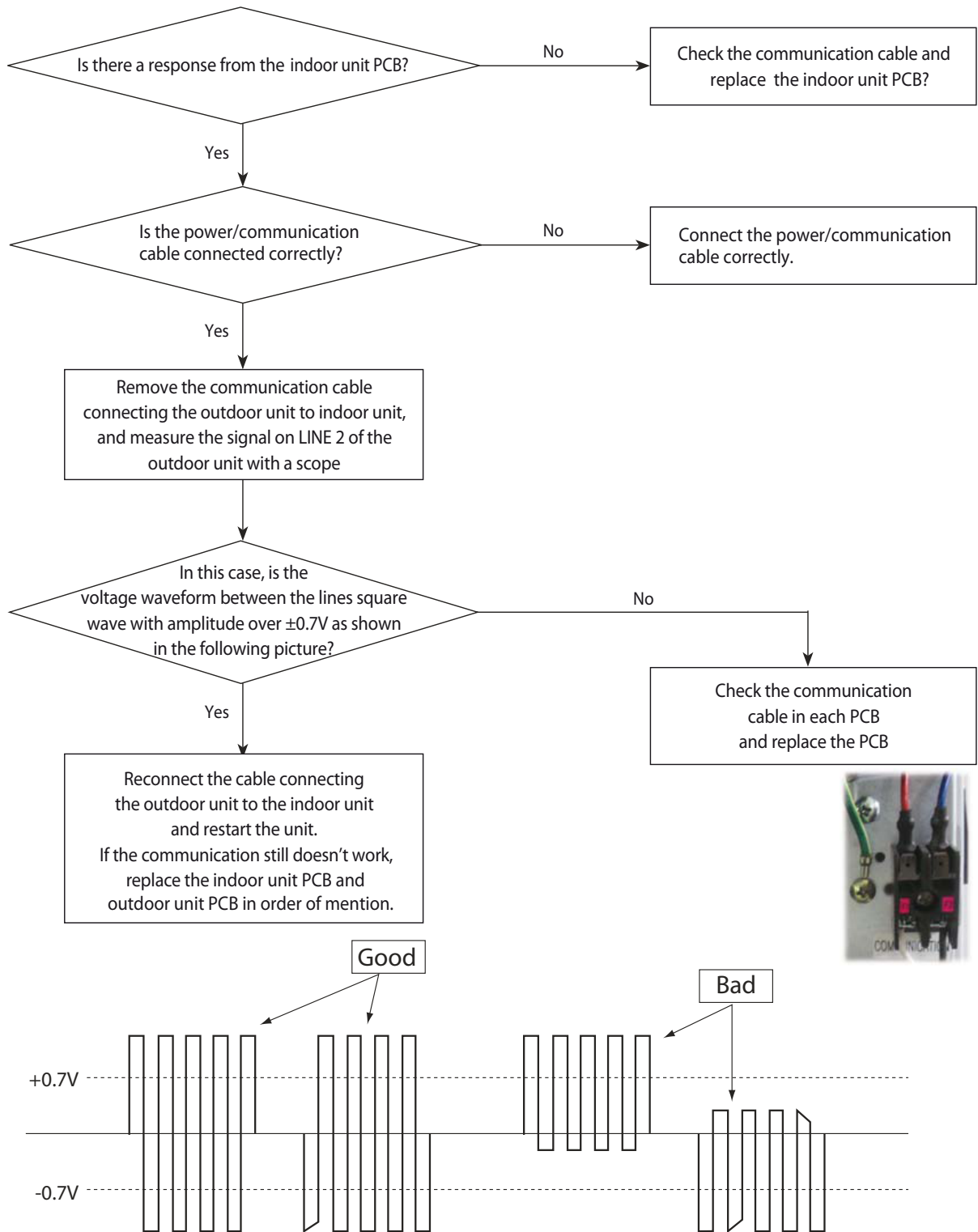

cf.) If there is no oscillo scope, it can be replaced multimeter instead of osillo scope.
 If measured voltage is floating value from 0.1V to 4.5V, then it means that the PCB is normal.

4-3-9 Outdoor's service valve(Clog)

Wire remote controller display	E422
Symptom	Clogging of outdoor's service valve
Failure	Valve clog

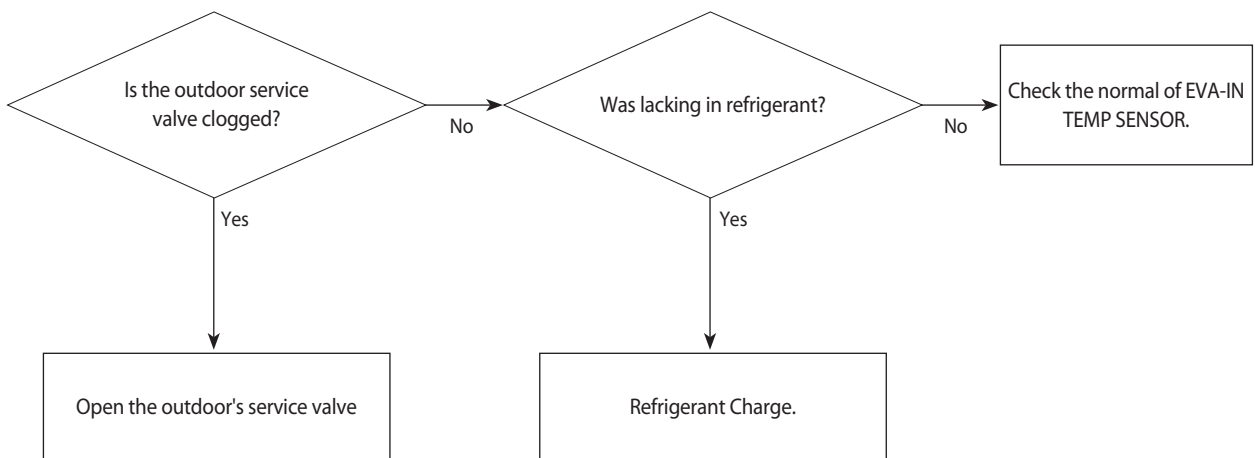

4-3-10 No Power(completely dead) - Initial diagnosis

Outdoor unit is not powered on – Initial diagnosis (1phase)

1. Check items
 - 1) Is the power supply voltage 220V?
 - 2) Is the AC power connected correctly?
 - 3) Are the LEDs in the main PCB and inverter PCB of the outdoor unit ON?
 - 4) Is the input power voltage of the indoor unit 220V?
 - 5) Is the wired remote controller connected correctly?
2. Check procedure

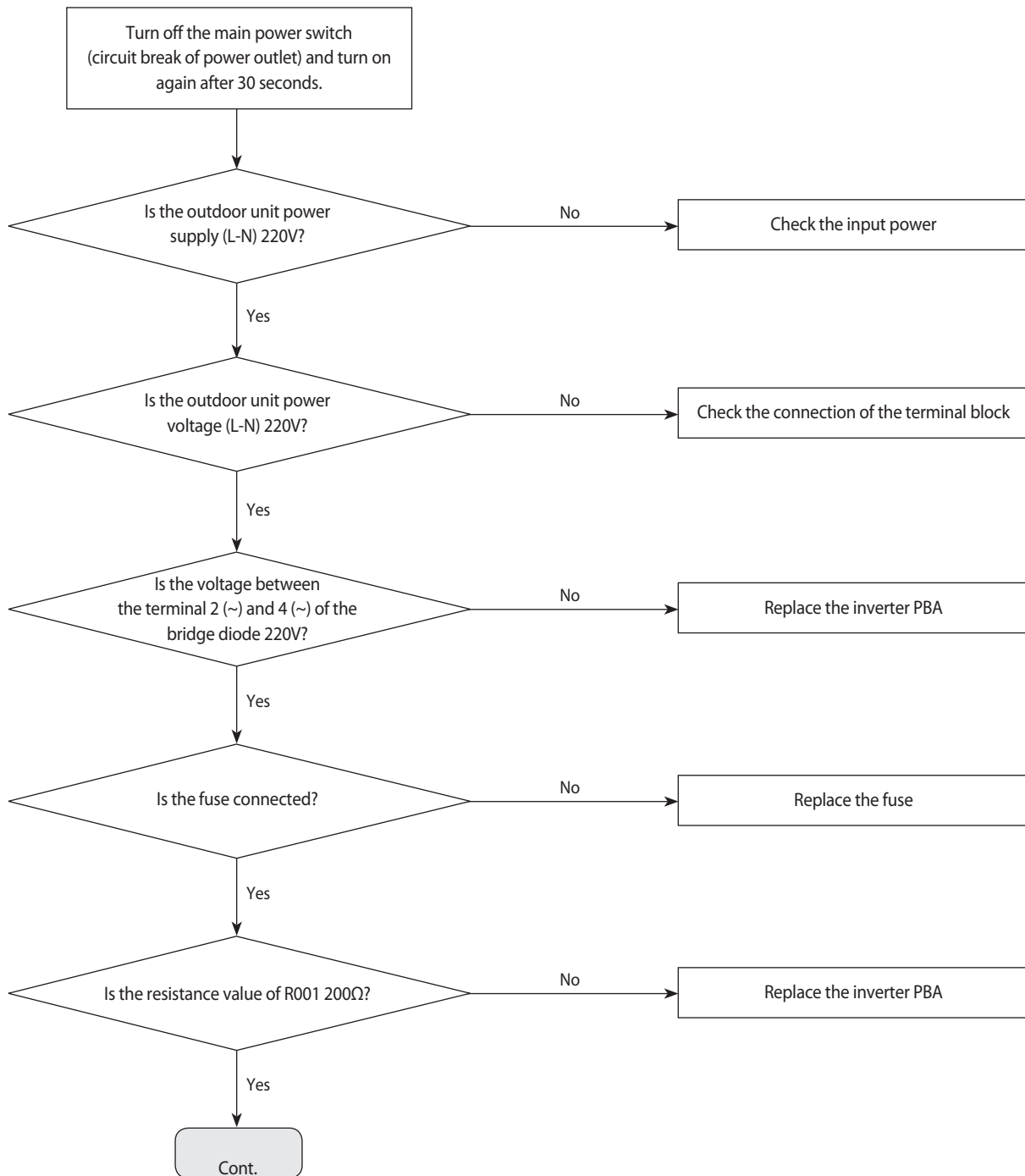

Outdoor unit is not powered on – Initial diagnosis (1phase) (cont.)

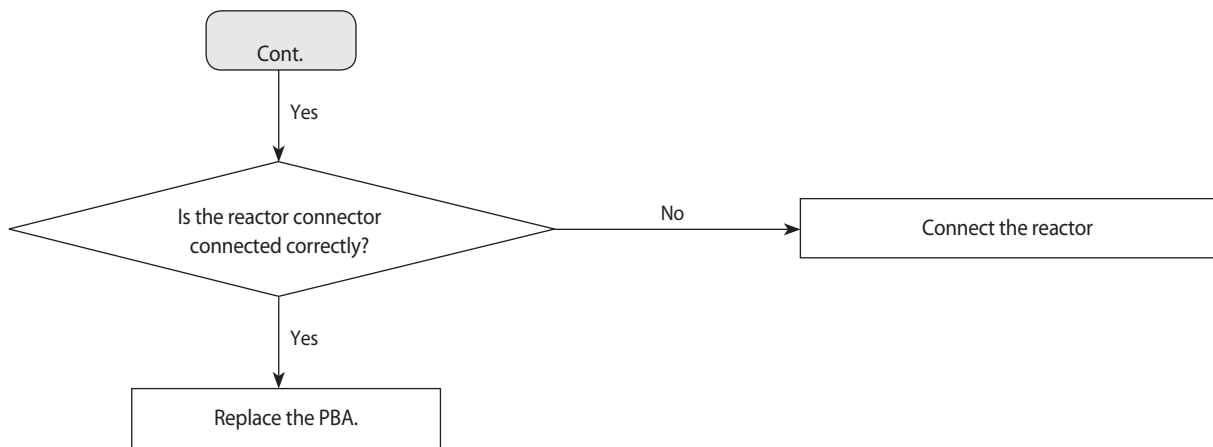

Outdoor unit is not powered on – Initial diagnosis (3phase)

1. Check items:
 - 1) Is the power supply voltage 380V?
 - 2) Is the AC power connected correctly?
 - 3) Are the LEDs in the main PCB and inverter PCB of the outdoor unit ON?
 - 4) Is the input power voltage of the indoor unit 220V?
 - 5) Is the wired remote controller connected correctly?

2. Troubleshooting procedure

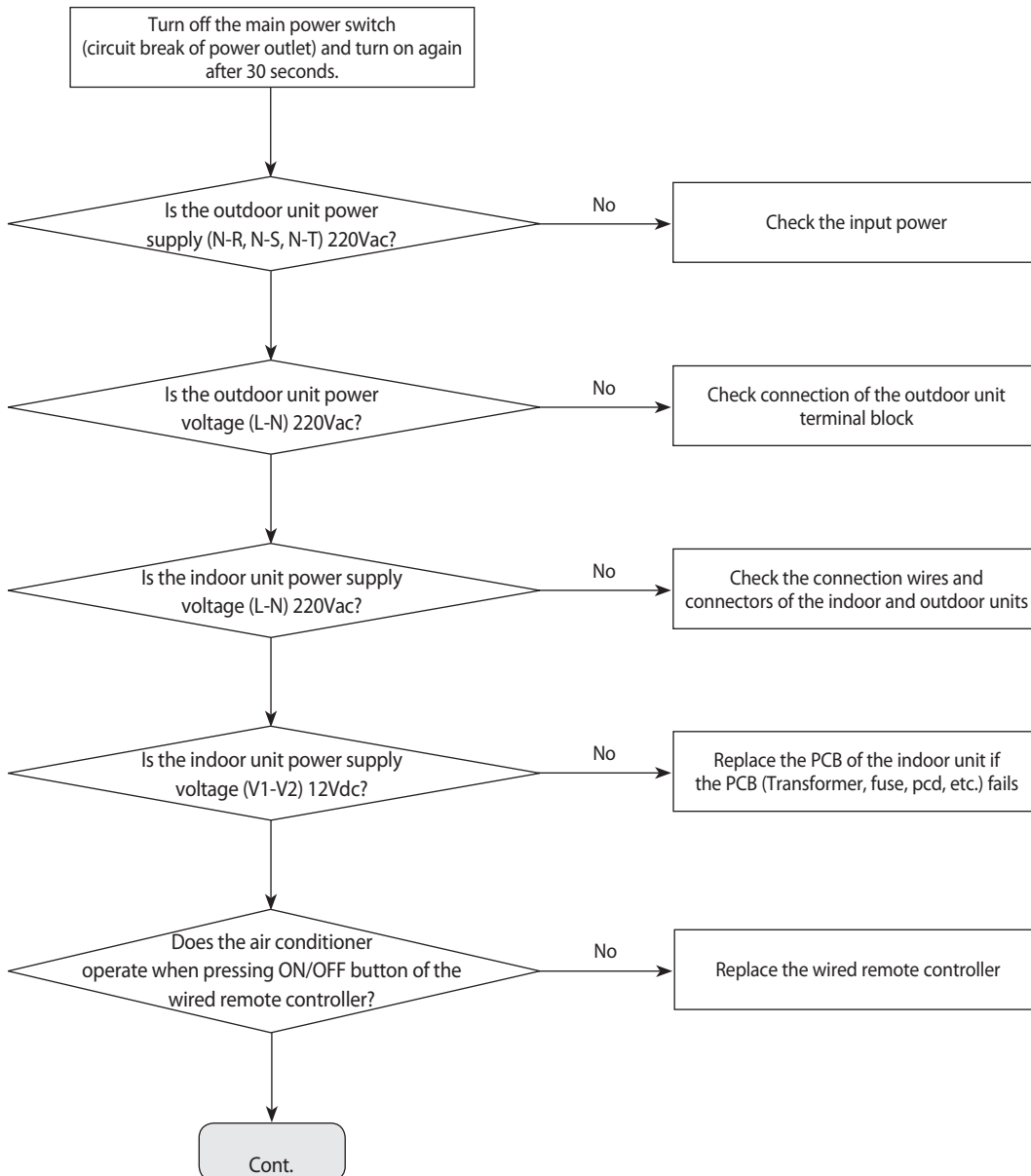

Outdoor unit is not powered on – Initial diagnosis (3phase) (cont.)

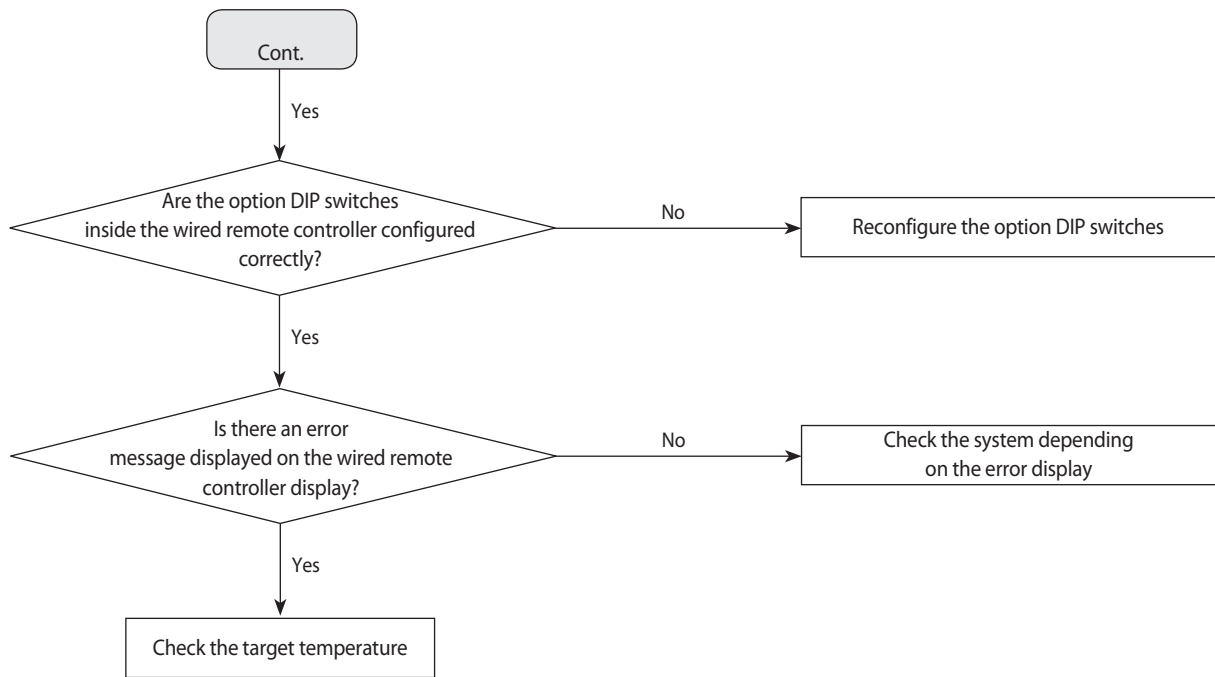

4-3-11 E102 : Communication error between indoor and outdoor unit
E201 : Unit quantity miss matching between Indoor and Outdoor
E202 : Abnormal state, no communication between Indoor and Outdoor Main PCB
E203 : 1min Time out of communication error(Main↔Inverter)

1. Checklist :

- 1) Is the communication cable between the indoor unit and outdoor unit connected correctly?
- 2) Isn't the power cable and communication cable wiring error?

2. Troubleshooting procedure

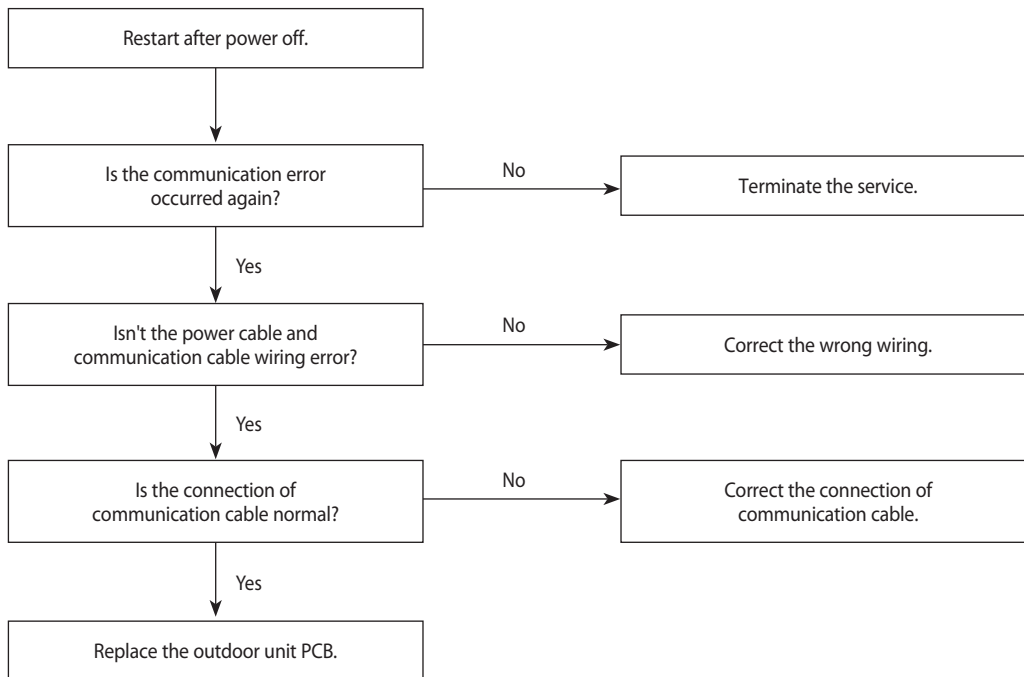

4-3-12 External Sensor Error (Error Code: E221, E231, E251, E320)

1. Test Item
 - 1) Check the connection of the temperature sensor connector.
 - 2) Check the resistance value of the temperature sensor.
2. Check procedure

Error Code	Description
E221	Error of the temperature sensor of the outdoor unit
E231	Error of the COND. sensor of the outdoor unit
E251	Error of the discharge sensor of the outdoor unit
E320	Error of the OLP sensor of the outdoor unit

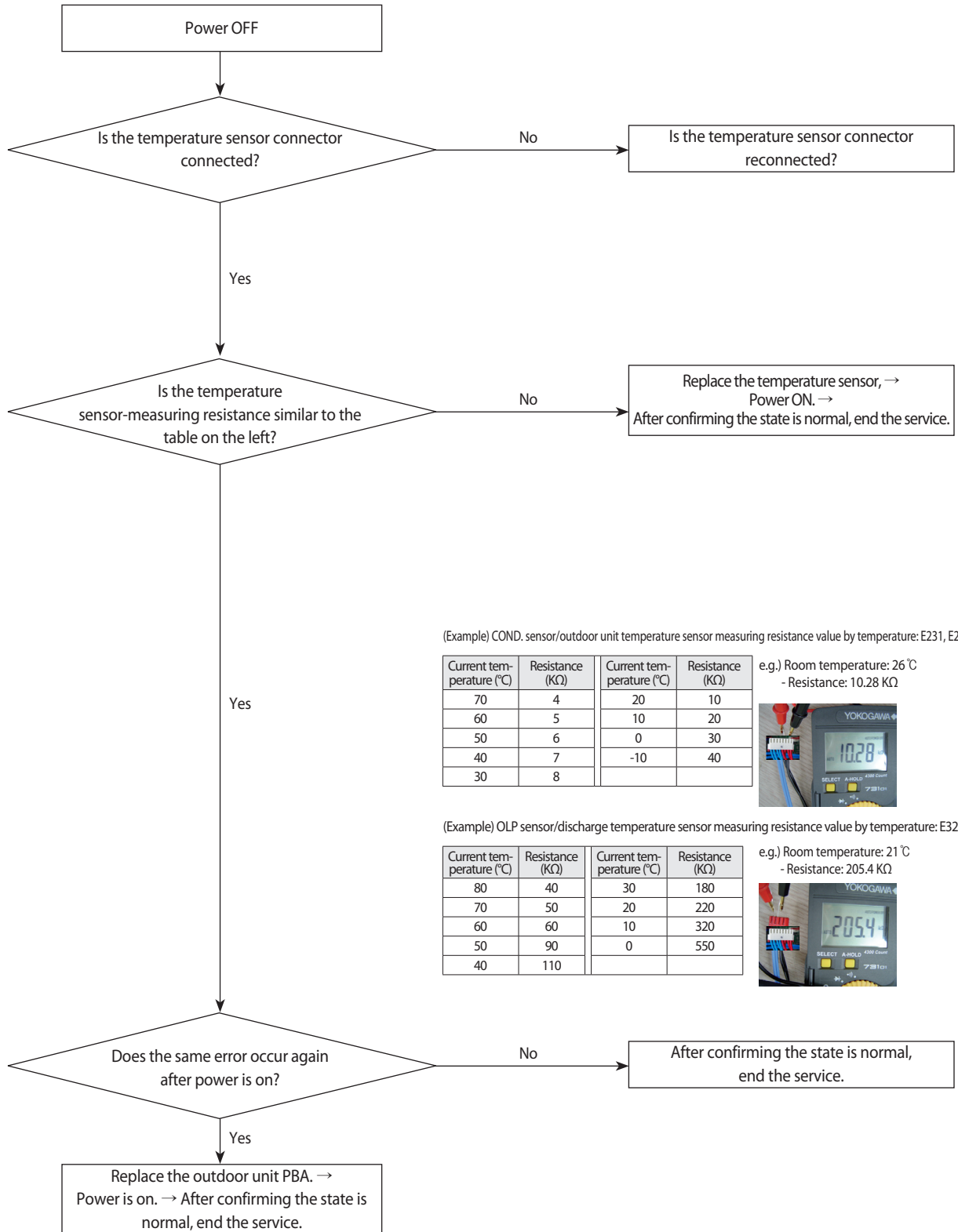

(Example) COND. sensor/outdoor unit temperature sensor measuring resistance value by temperature: E231, E221

Current temperature (°C)	Resistance (KΩ)	Current temperature (°C)	Resistance (KΩ)
70	4	20	10
60	5	10	20
50	6	0	30
40	7	-10	40
30	8		

e.g.) Room temperature: 26 °C
- Resistance: 10.28 KΩ



(Example) OLP sensor/discharge temperature sensor measuring resistance value by temperature: E320, E251.

Current temperature (°C)	Resistance (KΩ)	Current temperature (°C)	Resistance (KΩ)
80	40	30	180
70	50	20	220
60	60	10	320
50	90	0	550
40	110		

e.g.) Room temperature: 21 °C
- Resistance: 205.4 KΩ

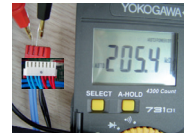

4-3-13 E403 : Freezing control causes comp. down

Outdoor unit display	E403
Criteria	•All the operating indoor machines do not reach -4°C for more than five minutes
Cause of problem	•Check if the indoor FAN/MOTOR operates normally. •Check if the indoor EEV operates normally. •Check the indoor heat Exchanger's IN/OUT sensor. •Check for clogging in the suction area of the indoor machine.

1. How to check

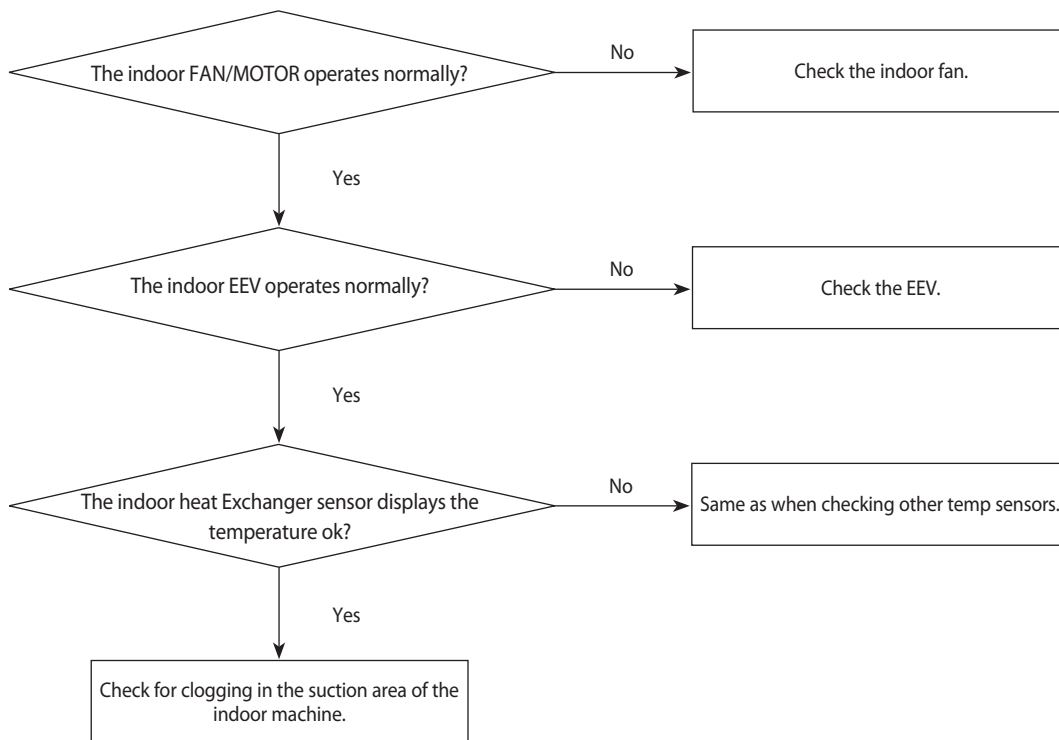

4-3-14 E416 : Dischage temperature sensor error

Outdoor unit display	E416
Criteria	•The compressor temperature above 110°C.
Cause of problem	<ul style="list-style-type: none"> •Insufficient coolant. •Clogging in the outdoor machine's solenoid valve. •Clogging in the sub valve. •Malfunctioning exhaust gas temp sensor. •Clogging in the pipeline and the filter. • Liquid EEV damaged.

1. How to check

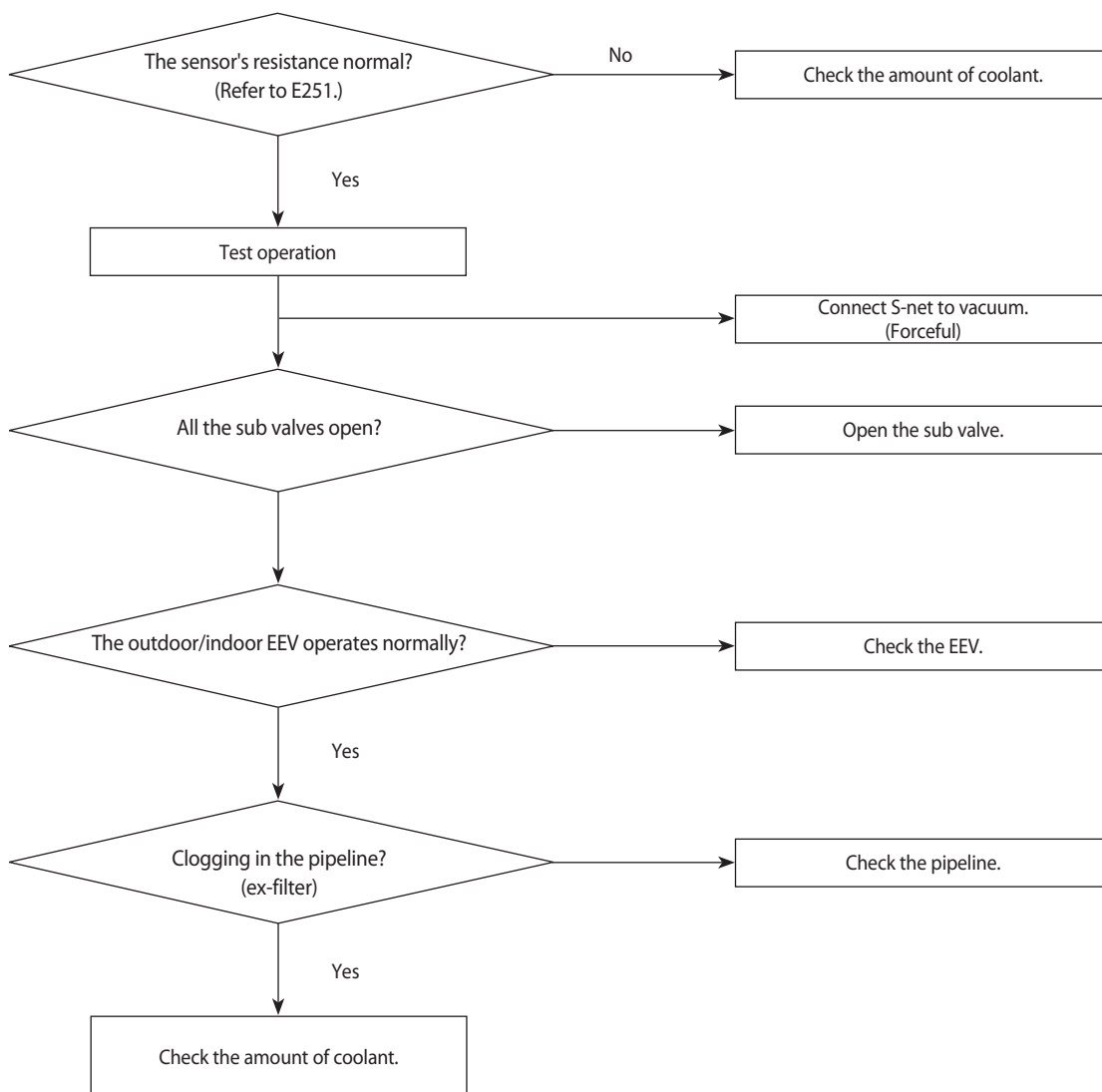

4-3-15 E440, E441 : Abnormal outside temperature halts operation of the compressor

Outdoor unit display	E440 (No heater operation with the outside temperature above 30°C.) E441 No AC operation with the outside temperature below -10°C.)
Criteria	•The compressor temperature above 110°C.
Cause of problem	E440: If the outside temperature is above 30°C, operation of the indoor heater with a remote control causes this error. E441: The indoor machine remote control ON signal. If the outside temperature is below -10°C before the AC runs, this error occurs.
Cause of problem	•OLP SENSOR temp above Trip_Dis.

1. How to check

The above malfunction codes do not indicate a malfunction of the product. All you have to do is change the temperature suitably for the limits shown in the manual. When the product malfunctions, if the actual situation does not match the above diagnosis, measure the temperature of incoming air with S-net to see if the measurement is the same as the actual outdoor temperature. If not, replace the temperature sensor.

4-3-16 Outdoor unit BLDC Fan1 or Fan2 error (E458 : Fan1 error, E475 : Fan2 error)

1. Checklist :

- 1) Isn't the fan locked?
- 2) Is the sensor placed correctly?
- 3) Does the both terminal of sensor satisfy the resistance value in accordance with temperature?
- 4) Is the resistance value of sensor connection pull_up correct?

2. Troubleshooting procedure

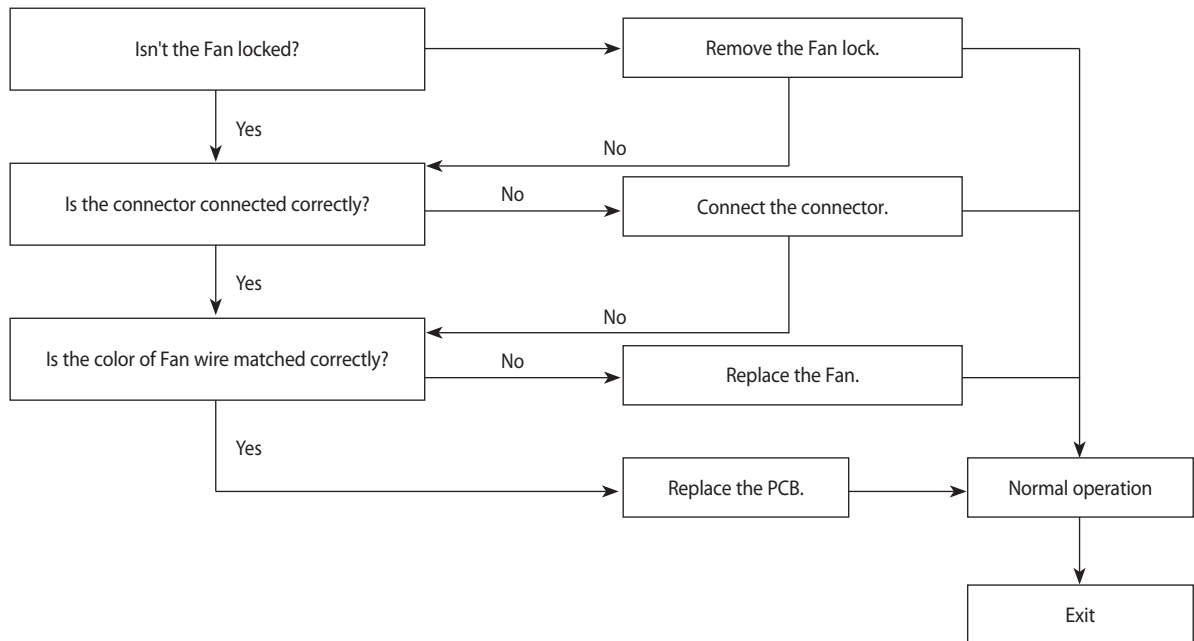

4-3-17 E461: Compressor start error E467: Compressor wire missing error

1. Checklist :
 - 1) Is the connection of cable for the compressor and power?
 - 2) Is the interphase resistance of compressor normal?
2. Troubleshooting procedure

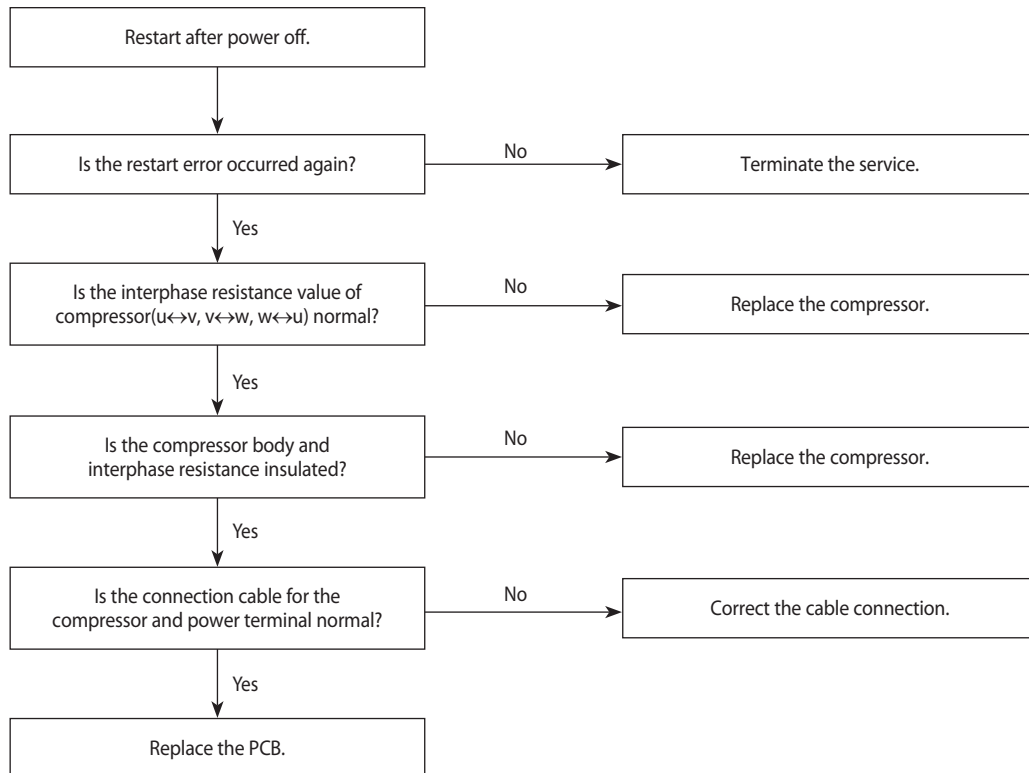

4-3-18 E462 : Current protection control causes comp. down E484 : PFC overload error

Outdoor unit display	E462,E484
Criteria	• The outdoor machine input current above I_Trip.
Cause of problem	• Check the compressor input voltage. (error for low voltage.) • Check the overcurrent option setting.

1. How to check

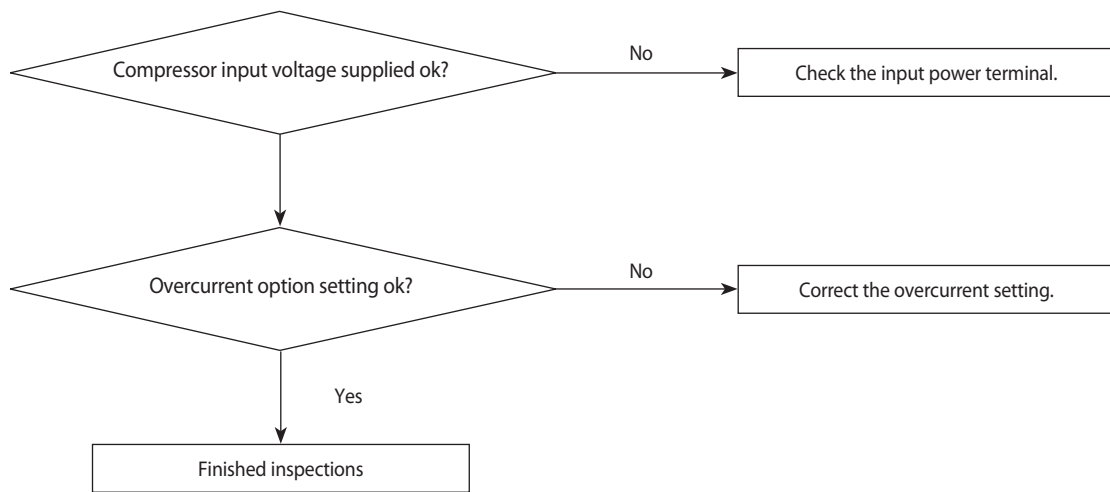

4-3-19 E463 : OLP protection control caused comp. down

Outdoor unit display	E463
Criteria	• OLP SENSOR temp above Trip_Dis.
Cause of problem	• See if the sub valve is open. • Check the amount of coolant. • Check the OLP sensor.

1. How to check

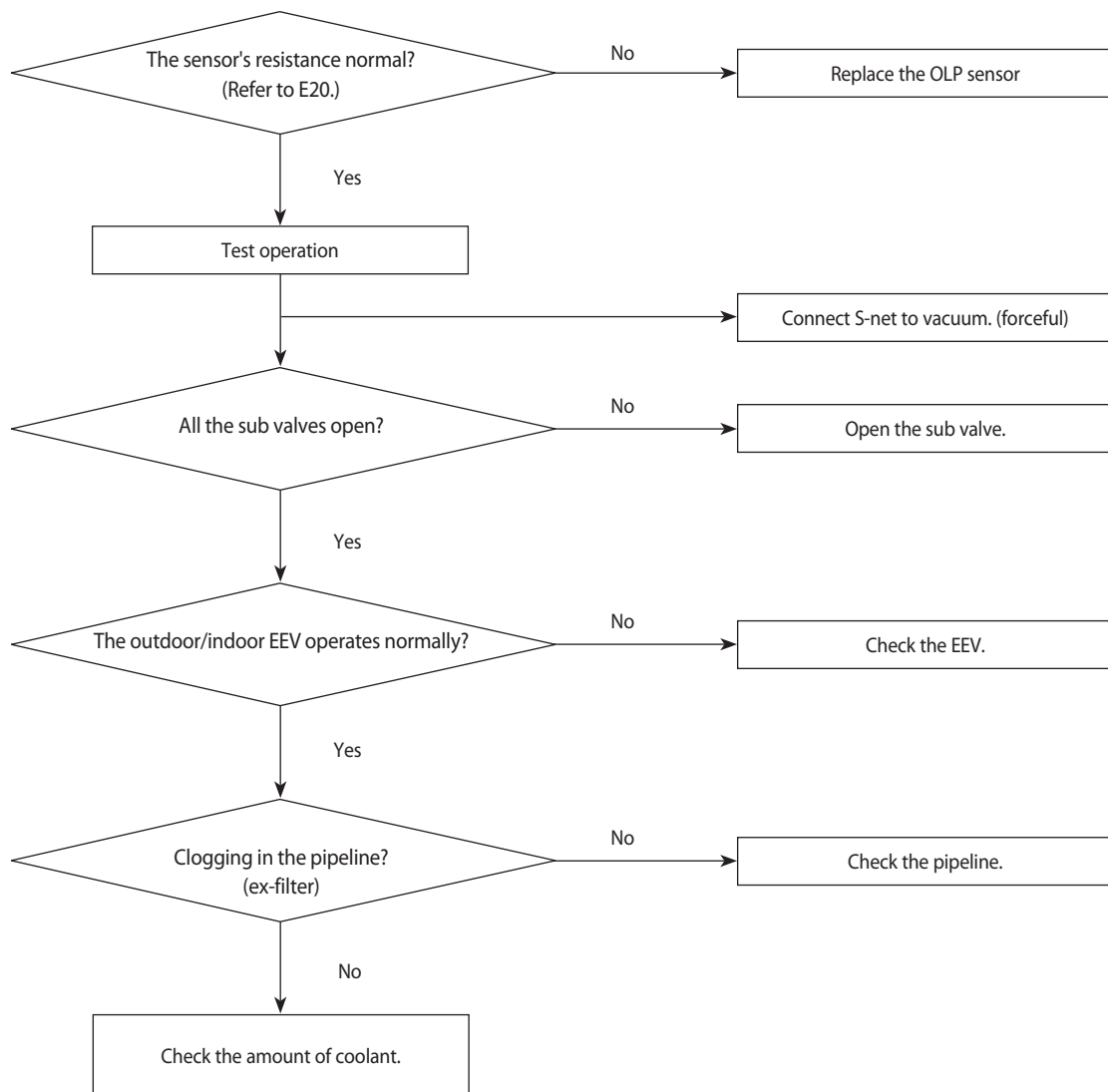

4-3-20 E464 : O.C. (Over Current) error

1. Checklist :

- 1) Is the refrigerant charged properly?
- 2) Does the compressor rotate normally?(Reverse rotation, Locking etc.)
- 3) Is connection of compressor wire normal?
- 4) Is compressor motor normal?(Insulation, Coil resistance etc.)
- 5) Does a temporary cycle overload condition happened?

2. Troubleshooting procedure

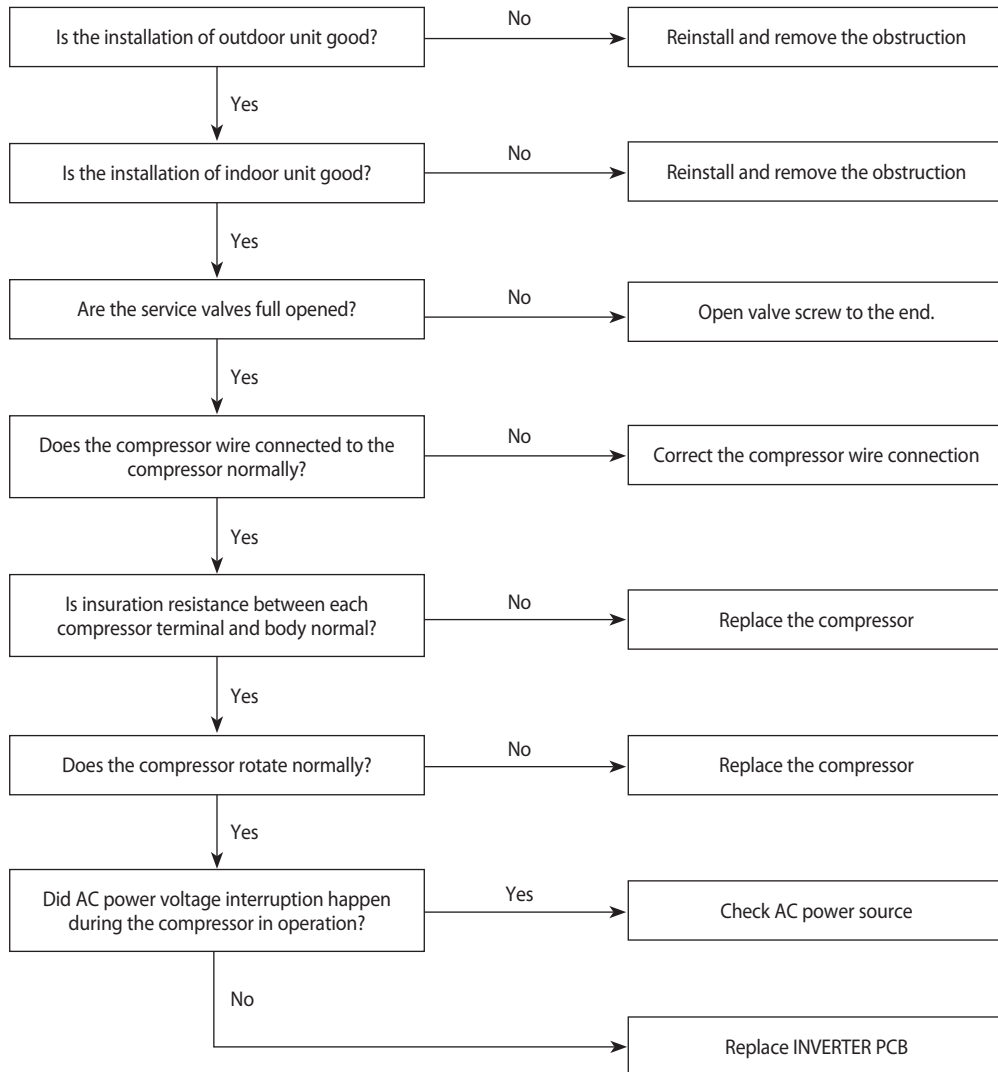

4-3-21 E466: DC Link Over voltage/ Low voltage error

1. Checklist :

- 1) Is the power voltage normal?(Lightning, Power interruption etc.)
- 2) Is AC Power cable connection normal?(Detaching the wire)

2. Troubleshooting procedure

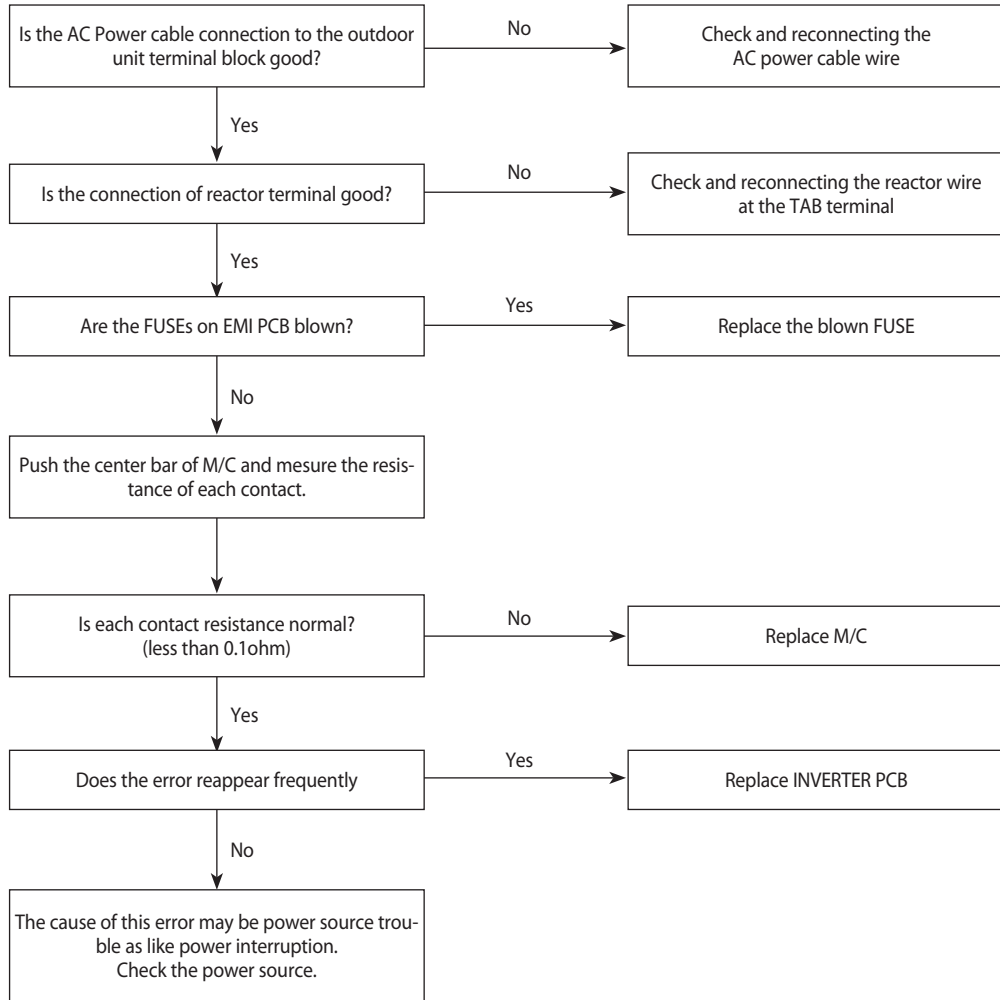

4-3-22 Pipe Blocking Error (Error Code: E422)

1. Test Item

- 1) Check the open state of the outdoor unit service valve.
- 2) Check the connection of the pipe.
- 3) Check the operation of the EEV.
- 4) Check the refrigerant leakage.
- 5) Check the connection of the indoor unit PBA EVA sensor.
- 6) Check the fault in the indoor unit EVA sensor.

2. Check procedure

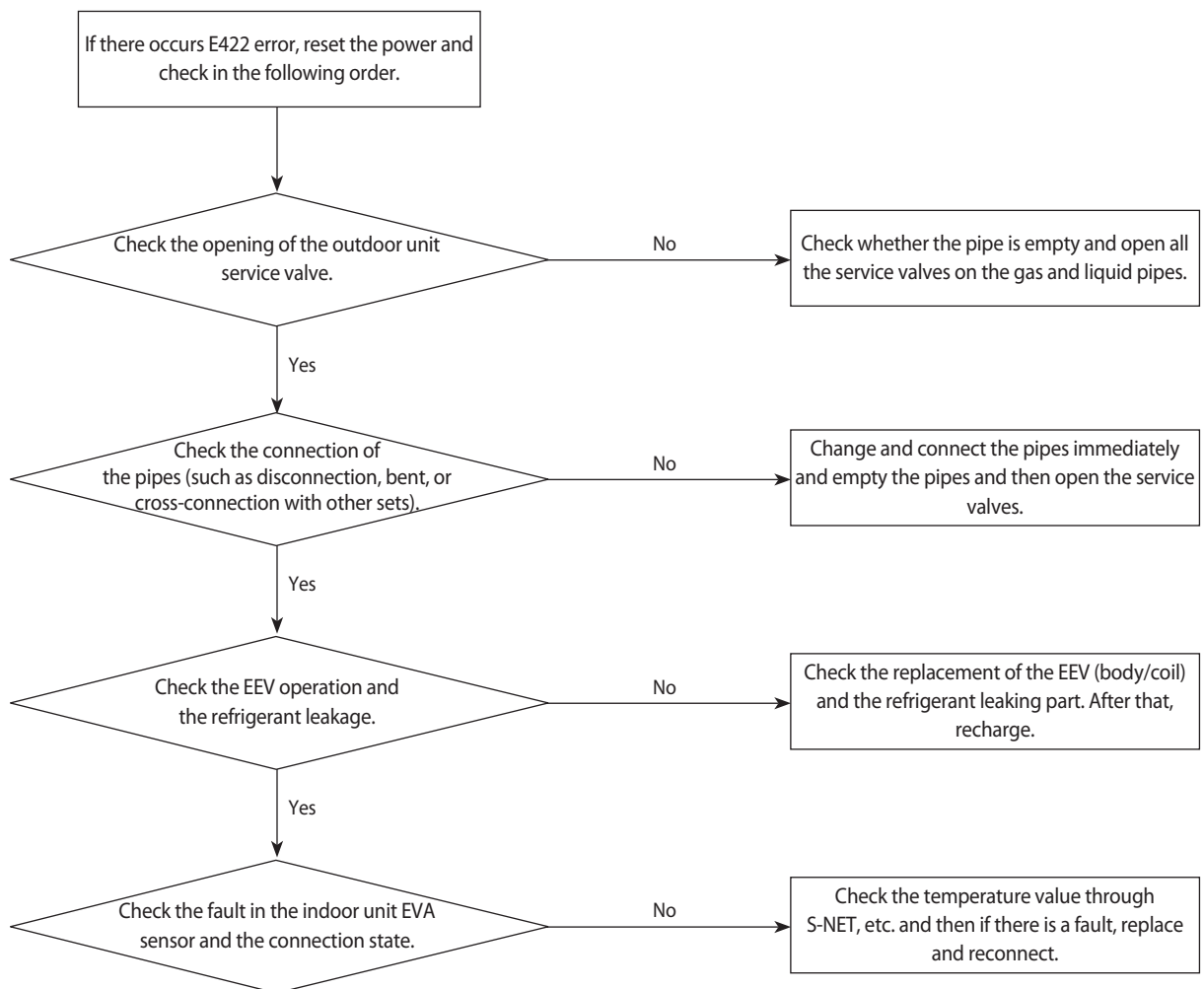

4-3-23 The others

1. E465 : Compressor over load error
 - If a compressor works improperly, change the compressor and check if it works properly.
 - If a compressor is normal, check the assembly between Heatsink-Inverter PBA. If it is fine, change Inverter PBA.

2. E468 : Current sensor error
 - Check EEPROM data.
 - Check PCB operates properly.

3. E471 : Outdoor EEPROM error
 - Upload EEPROM on Outdoor unit Main PBA.

4. E474 : IPM(IGBT Module) or PFCM Temperature sensor Error
 - E500 : IPM is over heated
 - Check IPM is well assembled to heatsink
 - Check whether inlet port is clogged.
 - Change IPM if it is defective one

5. E554 : Gas leak error
 - Check refrigerant charge
 - Check Indoor EVA sensor
 - Check Service valve is open.
 - Check the pipes and wires correctly connected.

6. E556 : Capacity miss match between indoor and outdoor
 - Check the model name of indoor and outdoor unit and set option code on indoor unit again.

7. Outdoor overload protection control (at the stop of the compressor) : E404
 - Check whether the fan and the motor operate normally.
 - Check the operation of EEV.
 - Check the temperature sensor of the indoor unit heat Exchanger.
 - Check the indoor unit inlet blocking.

4-4 Setting Option Setup Method

■ Setting Option Setup Method

In order to set the indoor unit option code use the wired remote controller and follow the directions below.

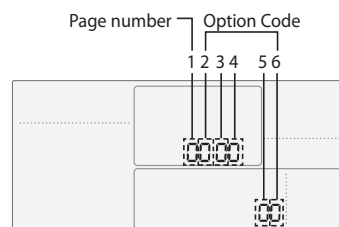
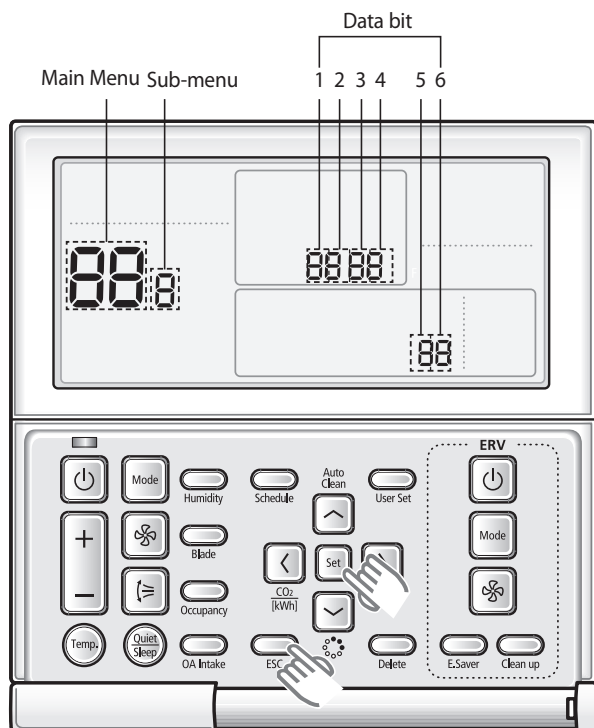

SEG1	SEG2	SEG3	SEG4	SEG5	SEG6
0	*	*	*	*	*

Page number

SEG7	SEG8	SEG9	SEG10	SEG11	SEG12
1	*	*	*	*	*

Page number

SEG13	SEG14	SEG15	SEG16	SEG17	SEG18
2	*	*	*	*	*

Page number

SEG19	SEG20	SEG21	SEG22	SEG23	SEG24
3	*	*	*	*	*

Page number

- 1) Press the **Set** and **ESC** buttons at the same time for more than 3 seconds and then a Main menu will be displayed.
- 2) Press the **▲/▼** button to select **4** and then press **▶** button to enter a Sub-menu setting screen.
- 3) Press the **▲/▼** button to select **2** and then press **▶** button to enter a Indoor unit option code setting screen.



NOTE

- The first digit represents the page number and the remaining five digits are option codes.
- The option code which is currently setting will flicker.

- 4) Press the **▲/▼** button to set the option code in order. Press **▶** button to go to the next page.
- 5) Press the **Set** button to save and complete the option setting.
- 6) Press the **ESC** button to exit to normal mode.



NOTE

- Press the **ESC** button anytime during setup to exit without setting.



CAUTION

- Option code will not be applied if you don't press the **Set**
- Setting indoor unit option code is only possible in Master wired remote controller. You can only check the indoor unit option code in Slave wired remote controller.
- Setting indoor unit option code is possible when one indoor unit is connected. If more than 2 indoor units are connected, you can only check the Master indoor unit option code.

Setting an indoor unit address and installation option

Set the indoor unit address and installation option with remote controller option. Set the each option separately since you cannot set the ADDRESS setting and indoor unit installation setting option at the same time. You need to set twice when setting indoor unit address and installation option.

Setting an indoor unit address

- 1) Press the **Set** and **ESC** buttons at the same time for more than 3 seconds and then a Main menu will be displayed.
- 2) Press the **↑**/**↓** button to select **4** and then press **→** button to enter a Sub-menu setting screen.
- 3) Press the **↑**/**↓** button to select **1** and then press **→** button to enter a Indoor Address setting screen.

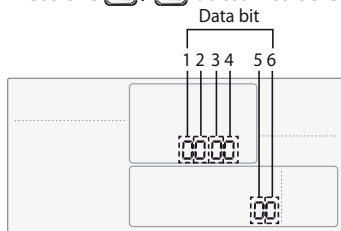

NOTE

- The Main/RMC Address which is currently setting will flicker.
- Data bit 1 and 2 present Indoor unit main address checking
- Data bit 3 and 4 present Indoor unit main address setting(outdoor unit reset is needed to set).
- Data bit 5 and 6 present Indoor unit RMC address setting/checking.

- 4) Press the **↑**/**↓** button to set the Indoor unit Main/RMC Address.
- 5) Press the **Set** button to save and complete the option setting.
- 6) Press the **ESC** button to exit to normal mode.









NOTE

- Press the **ESC** button anytime during setup to exit without setting.
- Address will not be applied if you don't press **Set** button.
- Setting Main/RMC Address of an Indoor unit is available only with a master wired remote controller.

Setting an indoor unit address and installation option

Setting an indoor unit installation option

In order to check and set the indoor unit installation option code use the wired remote controller and follow the directions below.

- 1) Press the  and  buttons at the same time for more than 3 seconds and then a Main menu will be displayed.
- 2) Press the  button to select **4** and then press  button to enter a Sub-menu setting screen.
- 3) Press the  button to select **3** and then press  button to enter a Indoor unit installation option code setting screen.



NOTE

- The first digit represents the page number and the remaining five digits are installation option.
- The total option codes are 24 digits. You can set six digits at a time and it is distinguished by page number (0, 1, 2, 3).

- 4) Press the  button to set the installation option code in order. Press  button to go to the next page.

SEG1	SEG2	SEG3	SEG4	SEG5	SEG6
0	2	RESERVED	Exterior temperature sensor	Central control	RESERVED
SEG7	SEG8	SEG9	SEG10	SEG11	SEG12
1	Drain pump	Use of Hot Coil	RESERVED	RESERVED	Master / Slave
SEG13	SEG14	SEG15	SEG16	SEG17	SEG18
2	External control	External control output	S-Plasma ion	Buzzer	Number of hours using filter
SEG19	SEG20	SEG21	SEG22	SEG23	-
3	Individual control of a remote controller	Heating setting compensation	RESERVED	Away Set OFF Timer	-



Option No. : 02XXXX-1XXXXX-2XXXXX-3XXXXX

Option	SEG1		SEG2		SEG3		SEG4		SEG5		SEG6	
Explanation	PAGE		MODE		RESERVED		Use of external temperature sensor		Use of central control		RESERVED	
Indication and Details	Indication	Details	Indication	Details			Indication	Details	Indication	Details		
	0		2				0	Disuse	0	Disuse		
					1	Use	1	Use				
Option	SEG7		SEG8		SEG9		SEG10		SEG11		SEG12	
Explanation	PAGE		Use of drain pump		RESERVED		RESERVED		RESERVED		Master / Slave	
Indication and Details	Indication	Details	Indication	Details							Indication	Details
	1		0	Disuse							0	slave
			1	Use							1	master
			2	Use + 3minute delay	-	-						
Option	SEG13		SEG14		SEG15		SEG16		SEG17		SEG18	
Explanation	PAGE		Use of external control		Setting the output of external control		Virus doctor		Buzzer control		Number of hours using filter	
Indication and Details	Indication	Details	Indication	Details	Indication	Details	Indication	Details	Indication	Details	Indication	Details
	2		0	Disuse	0	Thermo on	0	Disuse	0	Use of buzzer	2	1000 Hour
			1	ON/OFF Control	1	Operation on	1	Use	1	Non use of buzzer	6	2000 Hour
2			OFF Control									
Option	SEG19		SEG20		SEG21		-		-		-	
Explanation	PAGE		control of a remote controller		Heating setting compensation		-		-		-	
Indication and Details	Indication	Details	Indication	Details	Indication	Details	-		-		-	
	3		0 or 1	Indoor 1	0	Disuse	-		-		-	
			2	Indoor 2	1	2°C						
			3	Indoor 3	2	5°C						
4			Indoor 4									

5. Press the  button to save and complete the option setting.

6. Press the  button to exit to normal mode.

 NOTE

- Press  button anytime during setup to exit without setting.
- Option code will not be applied if you don't press  button.
- Setting Installation option code is available only with a master wired remote controller.
- Setting Installation option code is available when there is one on one connection between a wired remote controller and an indoor unit.

Adjusting air flow

E. S. P(External Static Pressure) setting for phase control motor

With its phase control motor, you can adjust the indoor unit fan speed depending on the installation condition. If the external static pressure is high so that the duct becomes longer or if the external static pressure is low so that the duct becomes shorter, adjust the fan speed by referring the following table.

Model	AC200JNHFKH	AC200JNHPKH	AC180JNH*KH	AC160JNH*KH
Static Pressure(mmAq)	Option code for indoor unit			
17.5 < SP ≤ 20	012474-1C548E-20C8E1-320000	012474-1C548E-20C8DC-320000	01107C-1C548E-27B414-370060	01107C-1C5468-27A0B4-370060
15 < SP ≤ 17.5	012474-1C5458-20C8E1-320000	012474-1C5458-20C8DC-320000	01107C-1C5458-27B414-370060	01107C-1C5448-27A0B4-370060
12.5 < SP ≤ 15	012474-1C5436-20C8E1-320000	012474-1C5436-20C8DC-320000	01107C-1C5436-27B414-370060	01107C-1C5437-27A0B4-370060
10 < SP ≤ 12.5	012474-1C50F5-20C8E1-320000	012474-1C50F5-20C8DC-320000	01107C-1C50F5-27B414-370060	01107C-1C50F5-27A0B4-370060
7.5 < SP ≤ 10	012474-1C50E3-20C8E1-320000	012474-1C50E3-20C8DC-320000	01107C-1C50E3-27B414-370060	01107C-1C50D3-27A0B4-370060
5 ≤ SP ≤ 7.5	012474-1C50C0-20C8E1-320000	012474-1C50C0-20C8DC-320000	01107C-1C50B0-27B414-370060	01107C-1C50A0-27A0B4-370060



NOTE

- represents E. S. P(External Static Pressure) range of factory setting. You don't have to adjust the fan speed separately if the external static pressure of the installation place is in . When it is out of , input the appropriate option code.
- If you input the inappropriate option code, error may occur or the air conditioner is out of order. The option code must be inputted correctly by the installation specialist or service agent.

Easy Tuning

EASY Tuning

If the more cooling and heating airflow rate which set up when installing is wanted, or if the more Silent operation which sets up when installing is wanted, air conditioner is tuned for comfort.

Indoor unit airflow rate for high, mid, low mode increases or decreases for +2 ~ -2 Steps with wired remotecon.

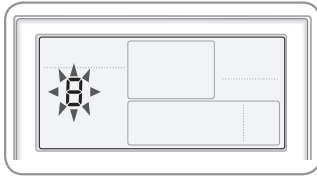

1. Press the User Set button.

▶ (Main Menu) will be displayed, and you can press the [A]/[V] buttons to select No. 8, which will set the Easy Tuning.

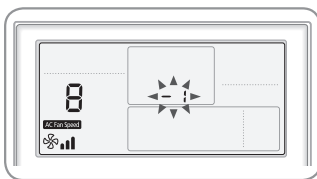

2. Press the [>] button to select airflow step.

▶ Press the [A]/[V] buttons to select airflow step(-2,-1,0,1,2) tuning (During the Easy Tuning setting, AC Fan Speed icon will be displayed)

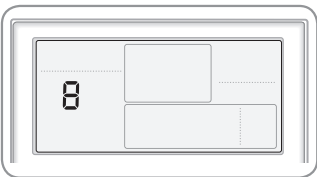

3) Press the [Set] button to complete the Easy Tuning.

(When the Easy Tuning setting complete, AC Fan Speed icon will be off)

4) Press the [ESC] button to to exit to normal mode.

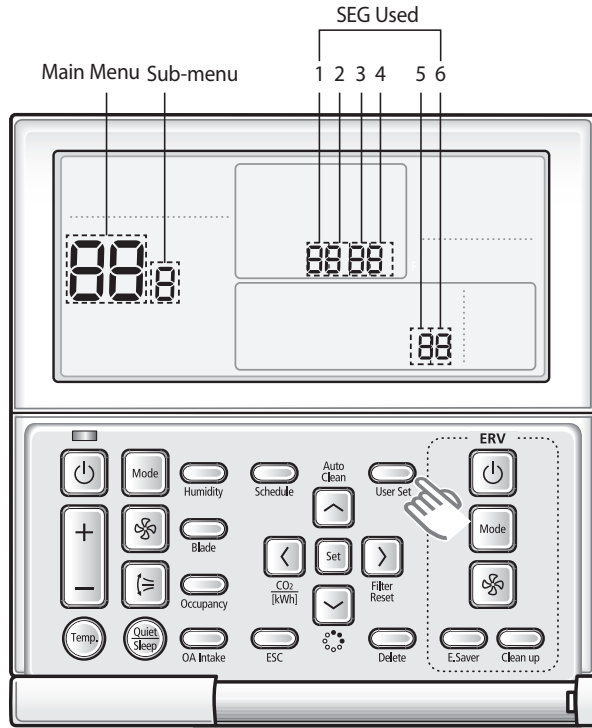

Main menu	Sub menu	Functions	SEG used	Default	Range
8	-	Easy Tuning	1,2	0	-2 : -2 Step -1 : -1 Step 0 : No Use 1 : +1 Step 2 : +2 Step



- Press the [ESC] button anytime during setup to exit without setting.
- According to airflow changed from the Easy Tuning, Air conditioning performance reducing is possible.

4-5 Items to be checked first

1. The input voltage should be rating voltage $\pm 10\%$ range.
The air conditioner may not operate properly if the voltage is out of this range.
2. Is the link cable linking the indoor unit and the outdoor unit linked properly?
The indoor unit and the outdoor unit shall be linked by 4 cables.
Check the terminals if the indoor unit and outdoor unit are properly linked by the same number of cables.
Otherwise the air conditioner may not operate properly.
3. When a problem occurs due to the contents illustrated in the table below it is a symptom not related to the malfunction of the air conditioner.

No	Operation of air conditioner	Explanation
1	In a COOL operation mode, the compressor does not operate at a room temperature higher than the setting temperature that the INDOOR FAN should operate. [In case of heat pump model] In a HEAT operation mode, the compressor does not operate at a room temperature lower than the setting temperature that indoor fan should operate.	In happens after a delay of 3 minutes when the compressor is reoperated. The same phenomenon occurs when a power is on. As a phenomenon that the compressor is reoperated after a delay of 3 minutes, the indoor fan is adjusted automatically with reference to a temperature of the air blew.
2	Compressor stops operation intermittently in DRY(☀) mode.	Compressor operation is controlled automatically in DRY mode depending on the room temperature and humidity.
3	[In case of heat pump model] Compressor of the outdoor unit is operating although it is turned off in a HEAT mode.	When the unit is turned off while de-ice is activated, the compressor continues operation for up to 12 minutes(maximum) until the deice is completed.
4	[In case of heat pump model] The compressor and indoor fan stop intermittently in HEAT mode.	The compressor and indoor fan stop intermittently if room temperature exceeds a setting temperature in order to protect the compressor from overheated air in a HEAT mode.
5	[In case of heat pump model] Indoor fan and outdoor fan stop operation intermittently in a HEAT mode.	The compressor operates in a reverse cycle to remove exterior ice in a HEAT mode, and indoor fan and outdoor fan do not operate intermittently for within 20% of the total heater operation

5. PCB Diagram and Part List

5-1 INDOOR UNIT

MAIN PBA

AC160JNHFKH/AC180JNHFKH/AC200JNHFKH/AC180JNHPKH/AC200JNHPKH

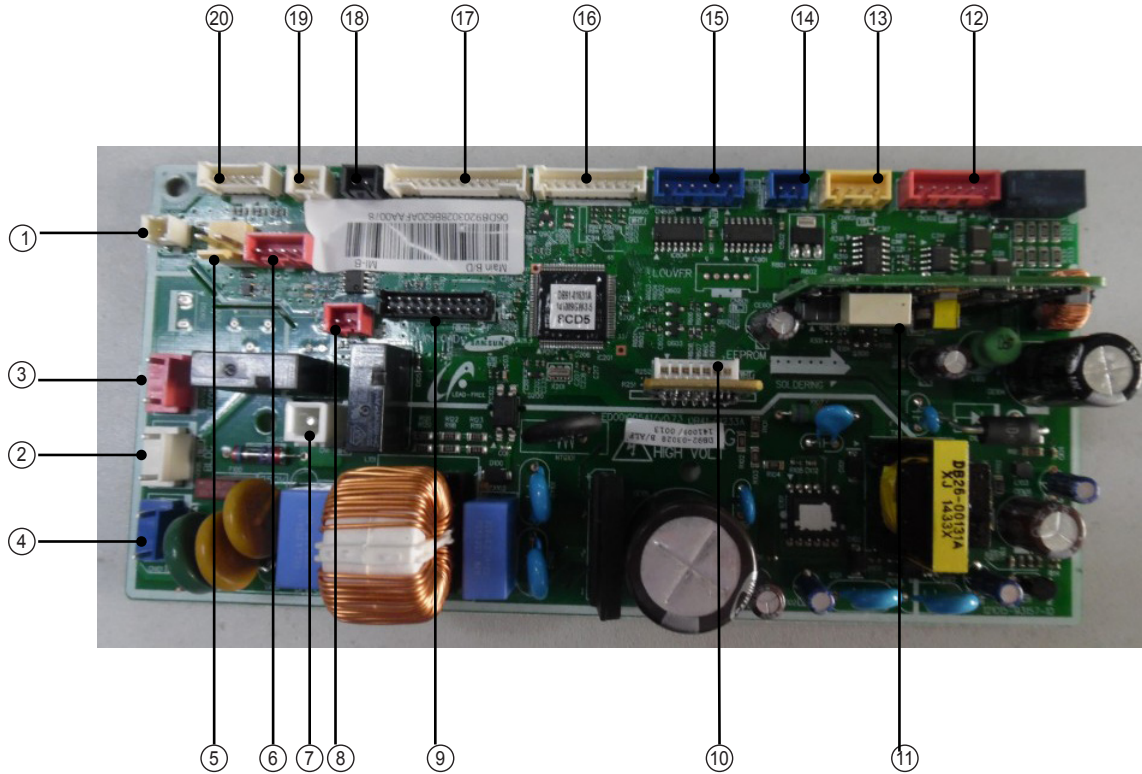

No	Part Code	Local	Function	Description
1	3711-003942	CN140	Fuse Check	SMW200-02P WHT
2	3711-000203	CN906	BLDC POWER	YW396-03AV WHT
3	3711-003407	CN702	Comp Signal	YW396-03AV RED
4	3711-003404	CN101	MAIN POWER	YW396-03AV BLU
5	3711-000179	CN701	DRAIN	YW396-02V YEL
6	3711-000939	CN81	COMP ERROR	SMW250-04 RED
7	3711-000744	CN1	EARTH	YDW236-01WHT
8	3711-000796	CN83	EXT-T	SMW250-02 RED
9	3711-002001	CN301	DOWNLOAD	YDW200-20
10	3711-007817	CN201	EPPROM	B7P-MQ WHT
11	3711-004773	CN311	2 WIRE	BMW200-12 WHT
12	3711-001037	CN302	COMM	SMW250-06 RED
13	3711-000941	CN801	SPI	SMW250-04 YEL
14	3711-000795	CN804	VEN	SMW250-02 BLU
15	3711-001036	CN808	EEV	SMW250-06 BLU
16	3711-004182	CN905	FAN MOTOR COMM	SMW200-10P WHT
17	3711-003895	CN501	DISPLAY	SMW200-13P WHT
18	3711-000794	CN411	FLOAT-SW	SMW250-02 BLK
19	3711-000015	CN412	ROOM SENSOR	SMW250-02 WHT
20	3711-004236	CN413	EVA DIS/OUT SENSOR	SMW200-06P WHT

EMI PBA

AC160JNHFKH/AC180JNHFKH/AC200JNHFKH/AC180JNHPKH/AC200JNHPKH

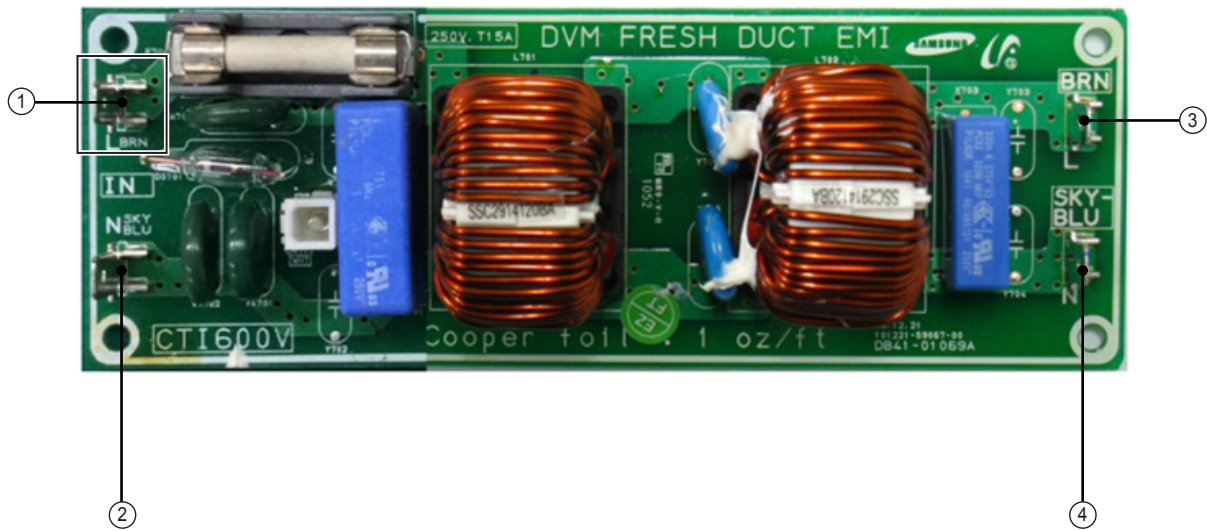

No.	part code	location No.	Function	Description
1	3712-001139	L	IN-L	TAB,MALE,6.35x0.8mm
2	3712-001139	N	IN-N	TAB,MALE,6.35x0.8mm
3	3712-001139	L	OUT-L	TAB,MALE,6.35x0.8mm
4	3712-001139	N	OUT-N	TAB,MALE,6.35x0.8mm

BLDC PBA
AC160JNHFKH/AC180JNHFKH/AC200JNHFKH/AC180JNHPKH/AC200JNHPKH

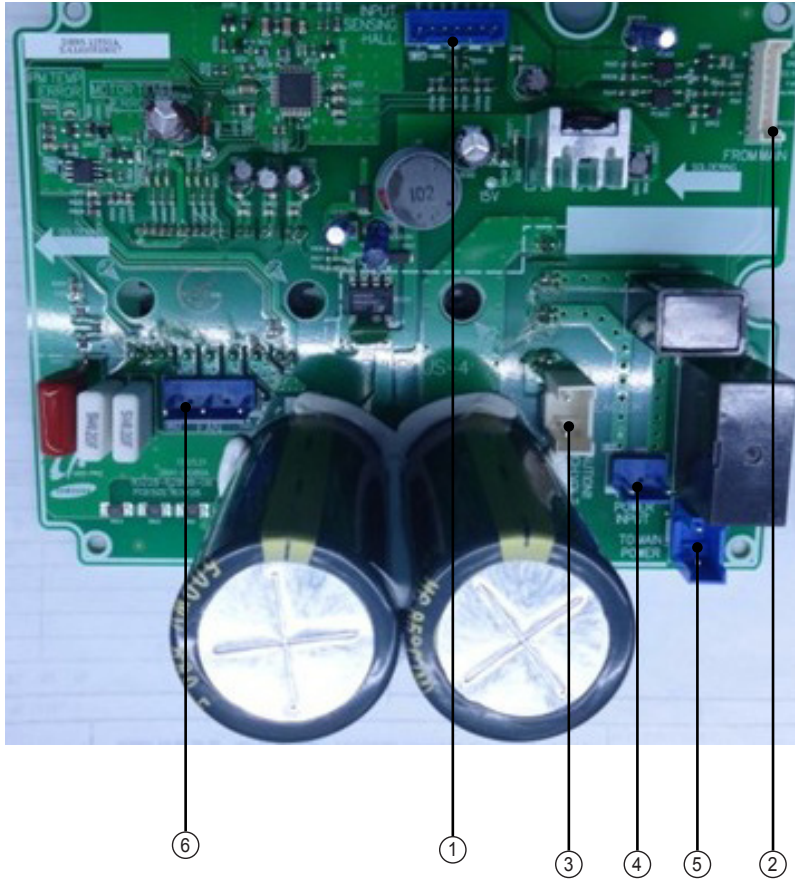

No	Part Code	Local	Description
1	3711-001080	CN12	Motor signal
2	3711-004712	CN11	Main to BLDC signal
3	3711-005852	CN15	Reactor connect
4	3711-003404	CN10	BLDC PBA power
5	3711-006048	CN14	Main PBA power
6	3711-000260	CN13	Motor power

5-2 OUTDOOR UNIT

MAIN PBA

AC160JXAFKH/AC160JXAFNH/AC180JXAFNH/AC180JXAPNH

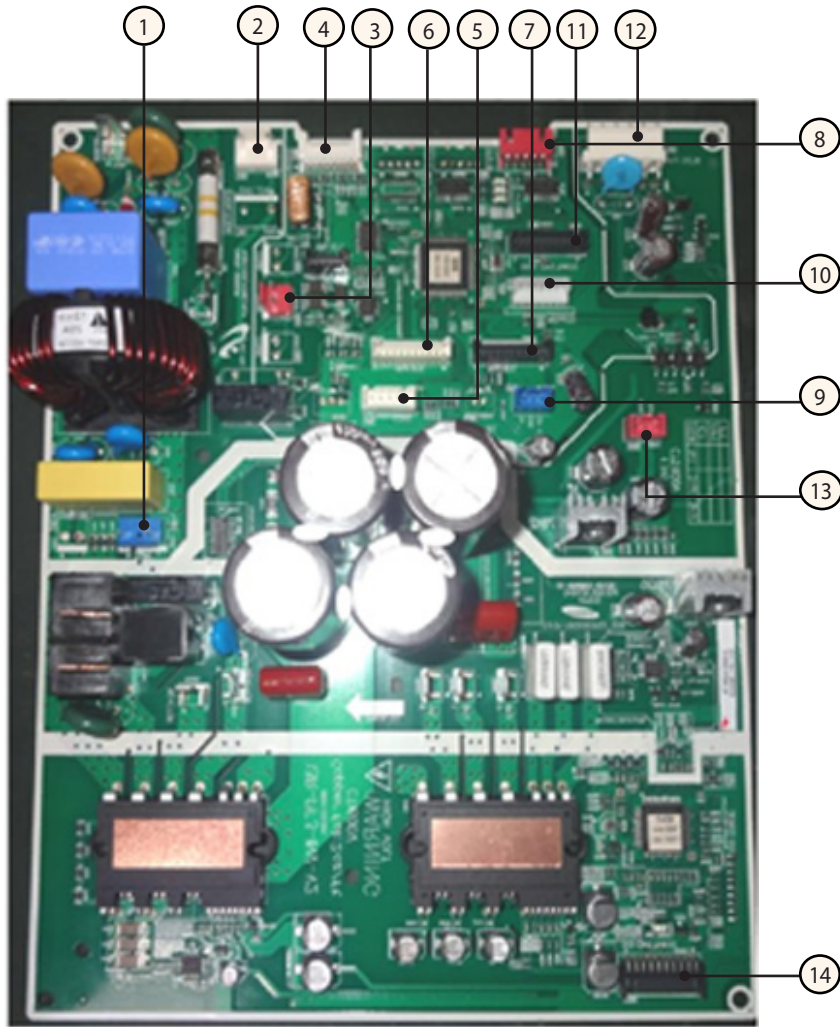

NO	Description
1	SMPS POWER: YW396-03AV BLU
2	4WAY:YW396-03AV WHT
3	COMM:YW396-02V RED
4	TEMP SENSOR: SMW200-08P WHT
5	DRED:SMW250-05 WHT
6	SUB PBA: SMW200-10P WHT
7	SUB PBA: SMW200-10P BLK
8	EEV1:SMW250-05 RED
9	SMPS: SMW250-03 BLU
10	EEPROM:B7P-MQ WHT
11	MAIN DOWNLOAD:YDW200-20 BLK
12	BLDC FAN:YAW396-06V WHT
13	ENABLE CGND: SMW250-03 RED
14	INV DOWNDOWN: YDAW200-20TR BLK

MAIN PBA
AC200JXAFNH/AC200JXAPNH

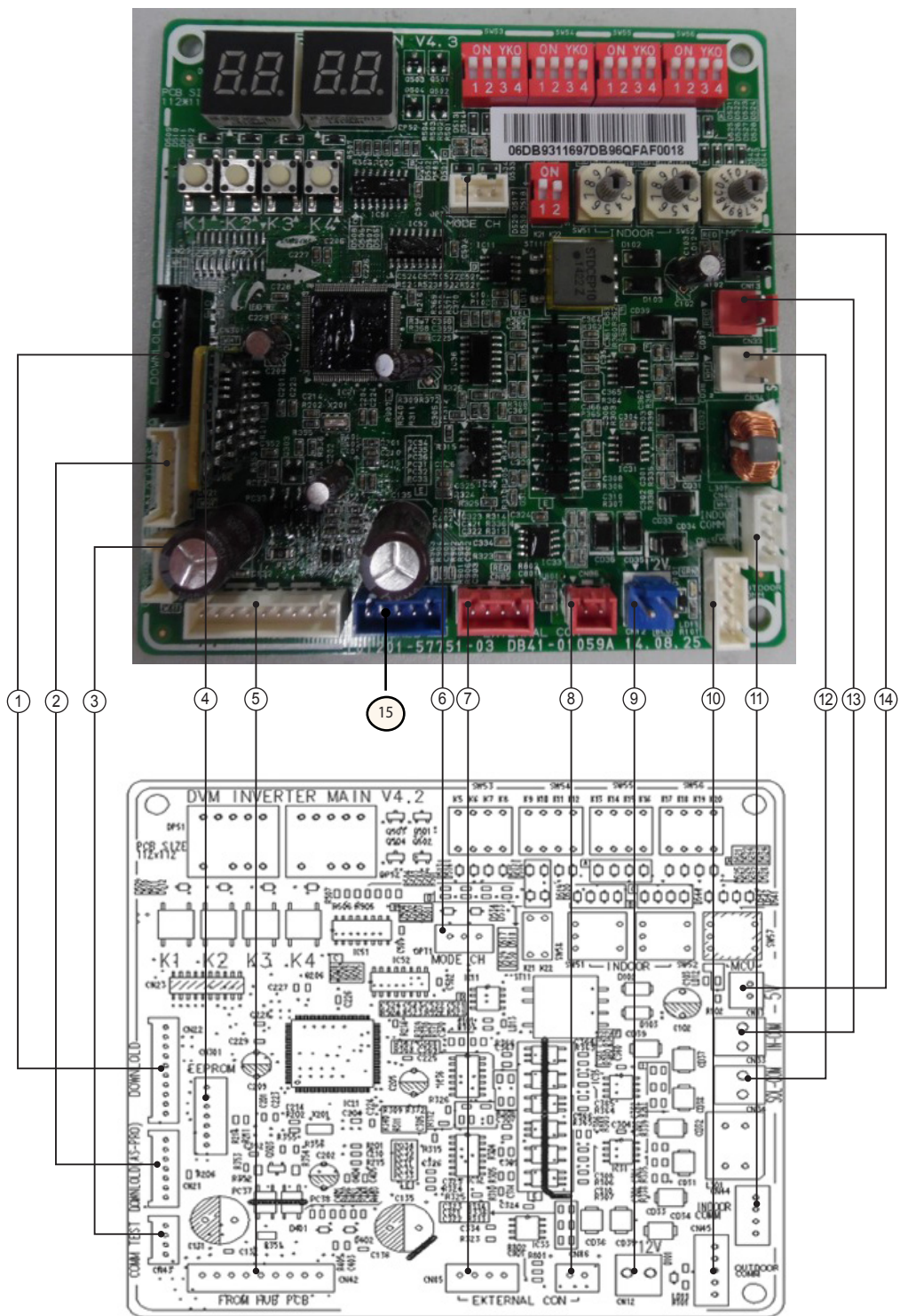

<p>① CN22-PC DOWN LOADER PART</p> <p>#1:RX-DOWN #2:TX-DOWN #3:N-TRST #4:TDO #5:TCK #6:TDI #7:TMS #8: #9:GND #10:VCC</p>	<p>② CN21-ASPRO DOWN LOADER PART</p> <p>#1:VCC #2:MODE0 #3:RESET_MAIN #4: #5: F_SCLK #6: F_SDAT #7:GND</p>	<p>③ CN43-COMM TEST</p> <p>#1:12V #2:INVERTER-INRUSH-OUT #3:INVERTER-COMM #4:GND</p>	<p>④ CN301-EEPROM</p> <p>#1:GND #2: #3:VCC #4:EEPROM-SELECT #5:EEPROM-SO #6:EEPROM-SI #7:EEPROM-CLOCK</p>
<p>⑤ CN42 - HUB COMMUNICATION</p> <p>#1:12V #2:INVERTER-INRUSH-OUT #3:INVERTER-COMM #4:GND #5:HIGH-PRESSURE-SENSOR #6:LOW-PRESSURE-SENSOR #7:ZERO-CROSSING #8:GND #9:VCC</p>	<p>⑥ OPTI -MODE SELECTOR</p> <p>#1:KEY3 #2:GRID #3:KEY4</p>	<p>⑦ CN85-STATE CHECK</p> <p>#1:12V #2:ERROR-CHECK-OUT #3:12V #4:COMP-CHECK-OUT</p>	<p>⑧ CN86-OUTSIDE CONTROLLER</p> <p>#1:CONTROL #2:GND</p>
<p>⑨ CN12-TRANSMITTER DC POWER 12V</p> <p>#1:12V #2:GND</p>	<p>⑩ CN45 -OUTDOOR UNIT COMM.</p> <p>#1:COM-C #2:COM-D #3: #4:12V #5:GND</p>	<p>⑪ CN44 - INDOOR UNIT COMM.</p> <p>#1:COM-A #2:COM-B #3:5V #4:AGND</p>	<p>⑫ CN34-NONUSE COMM.</p> <p>#1:COM-E #2:COM-F</p>
<p>⑬ CN33-INDOOR UNIT COMM. (REDUNDANCY)</p> <p>#1:COM-A #2:COM-B</p>	<p>⑭ CN13-POWER 5V</p> <p>#1:COM-A #2:COM-B</p>	<p>⑮ CN901 - DRED</p> <p>#1:DRED1 #2:DRED2 #3:DRED3 #4:GND #5:VCC</p>	

EMI PBA
AC160JXAFKH

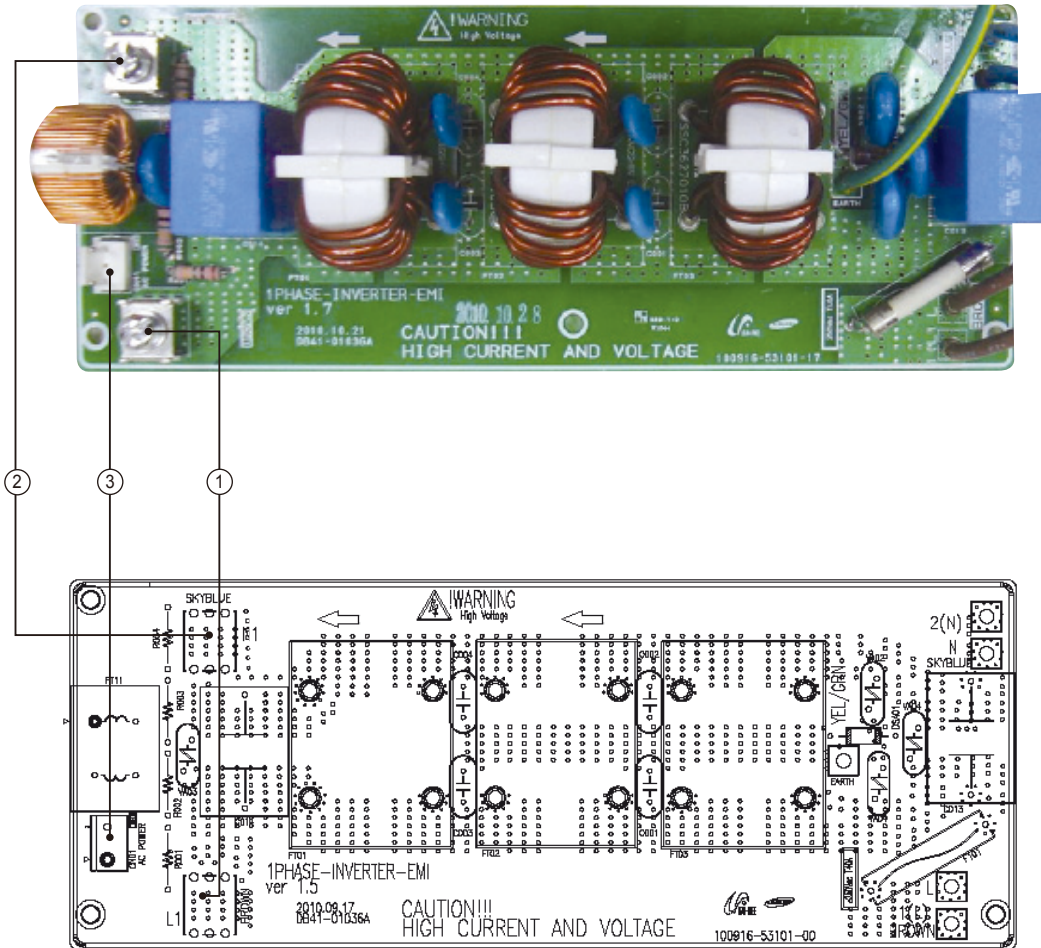

<p>① L1-AC POWER L phase L1 : BRN</p>	<p>② N1-AC POWER N phase N1 : SKY-BLU</p>	<p>③ CN01-AC POWER #1-#3 : AC 220~240V</p>
--------------------------------------------------	------------------------------------------------------	-------------------------------------------------------

EMI PBA
 AC160JXAFNH/AC180JXAFNH/AC180JXAPNH

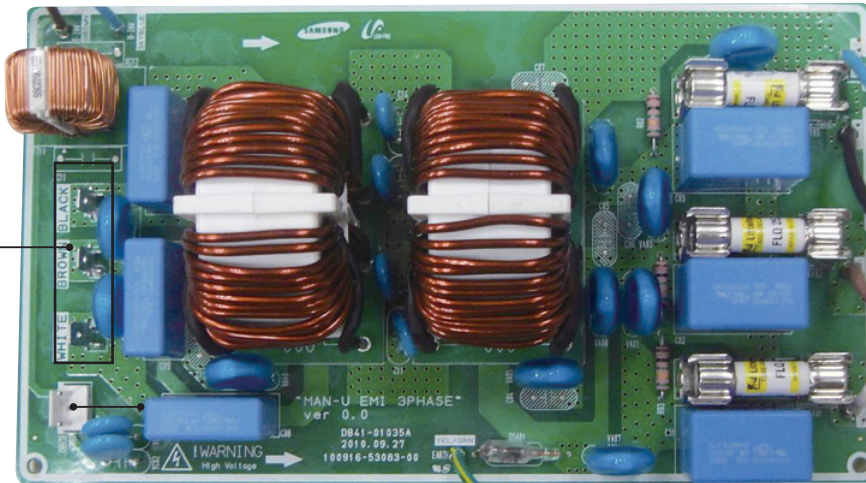

①

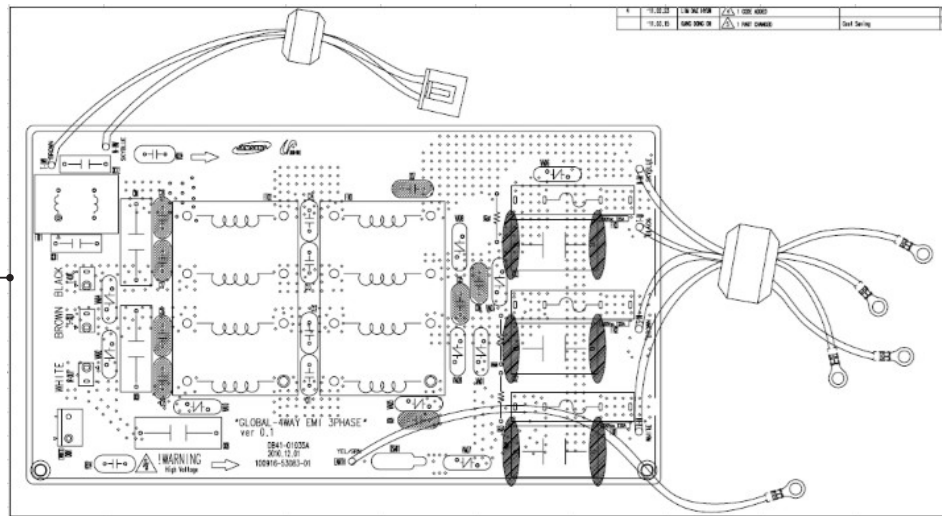

① **YW396-03AV(WHT)**
 #1: CN01

INV PBA
AC160JXAFKH

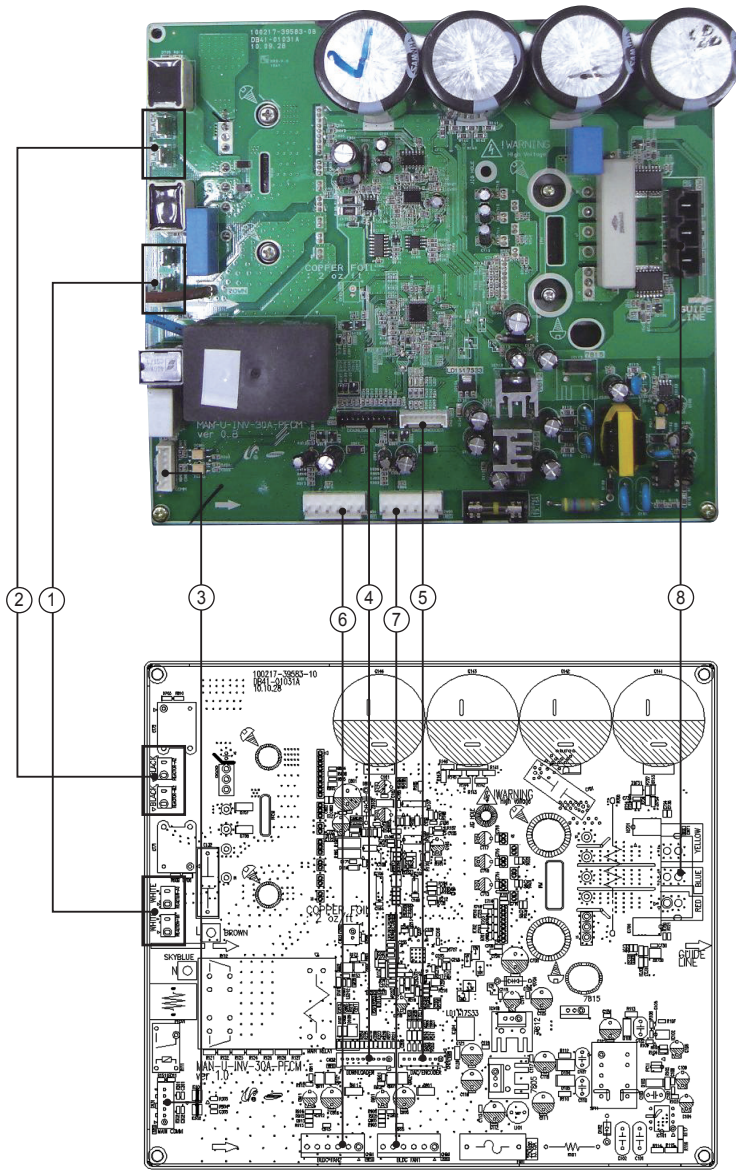

<p>① Reactor-A1/B1 #Reactor-A2 : WHT #Reactor-B2 : WHT</p>	<p>② Reactor-A2/B2 #Reactor-A2 : BLK #Reactor-B2 : BLK</p>	<p>③ CN50(2PIN/RED)-Communication #1 : RXD, #2 : TXD #3 : GND, #4 : DC 5V #5 : DC 12V, #6 : INV. SMPS signal</p>	<p>④ CN22-Downloader #1 : RXD_ATARO, #2 : TXD_ATARO #3, #8 : N.C, #4~#7 : DATA signal #9 : GND, #10 : DC 5V</p>
<p>⑤ CN21-DAC/ENCODER For S/W engineer debugging</p>	<p>⑥ CN91-FAN2 #1 : DC 360V #2 : N.C #3 : GND #4 : DC 15V #5 : FAN RPM #6 : FAN RPM feedback</p>	<p>⑦ CN90-FAN1 #1 : DC 360V #2 : N.C #3 : GND #4 : DC 15V #5 : FAN RPM #6 : FAN RPM feedback</p>	<p>⑧ CN71-COMP. #1 : COMP. U-phase(RED) #2 : COMP. V-phase(BLU) #3 : COMP. U-phase(YEL)</p>

INV PBA
 AC160JXAFNH/AC180JXAFNH/AC180JXAPNH

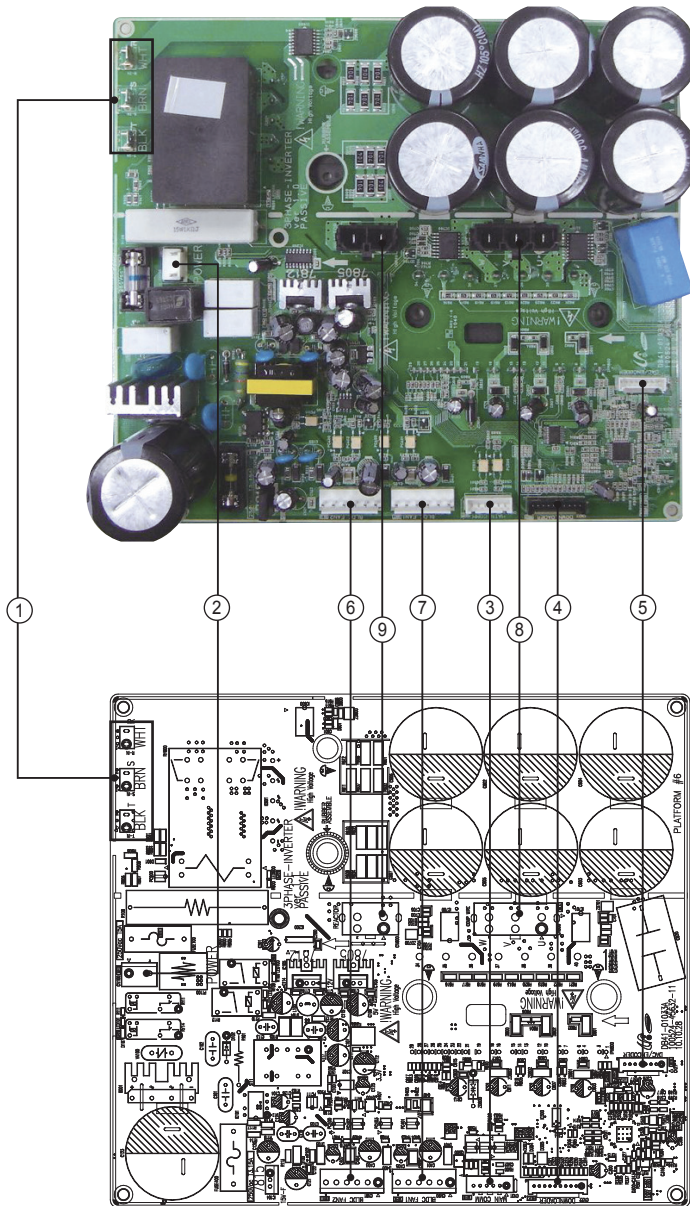

<p>① RST-AC POWER 3phase #R : AC 380~400V : WHT #S : AC 380~400V : BRN #T : AC 380~400V : BLK</p>	<p>② CN100-AC POWER #1-#3 : AC 220~240V</p>	<p>③ CN31-MAIN COMM #1 : RXD, #2 : TXD #3 : GND, #4 : DC 5V #5 : DC 12V, #6 : INV. SMPS signal</p>	<p>④ CN22-Downloader #1 : RXD_ATARO, #2 : TXD_ATARO #3, #8 : N.C, #4~#7 : DATA signal #9 : GND, #10 : DC 5V</p>
<p>⑤ CN21-DAC/ENCODER For S/W engineer debugging</p>	<p>⑥ CN91-FAN2 #1 : DC 360V, #2 : N.C #3 : GND, #4 : DC 15V #5 : FAN RPM, #6 : FAN RPM feedback</p>	<p>⑦ CN90-FAN1 #1 : DC 360V, #2 : N.C #3 : GND, #4 : DC 15V #5 : FAN RPM, #6 : FAN RPM feedback</p>	<p>⑧ CN800-COMP. #1 : COMP. U-phase(RED) #2 : COMP. V-phase(BLU) #3 : COMP. U-phase(YEL)</p>
<p>⑨ CN600-REACTOR #1-#2 : DCL Reactor</p>			

AC200JXAFNH/AC200JXAPNH

ASS'Y PCB MAIN-HUB

■ AC

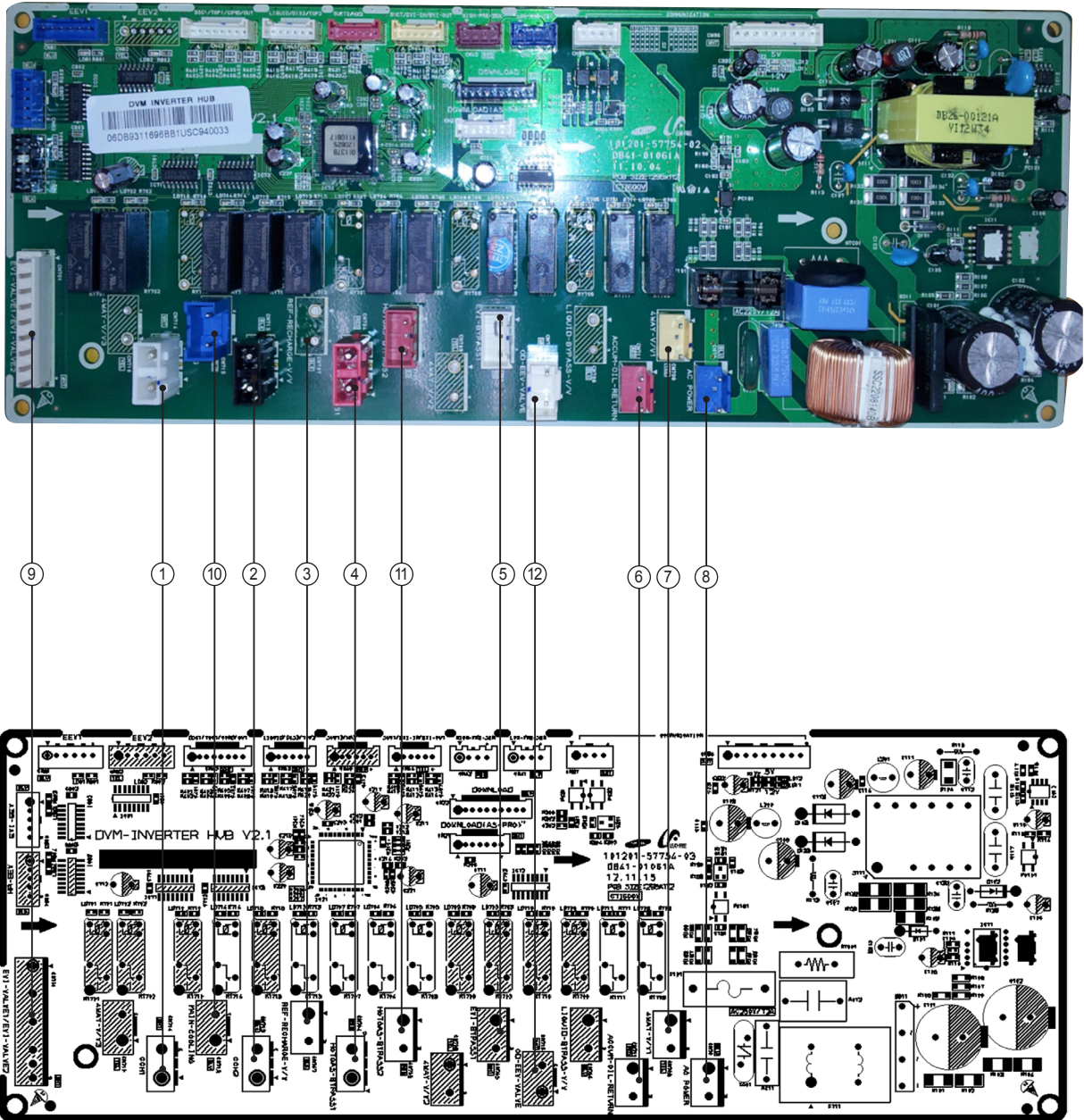

ASS'Y PCB MAIN-HUB (cont.)

■ AC (cont.)

<p>① CN714-CCH1</p> <p>#1:N #2:CCH1</p>	<p>② CN713-CCH2</p> <p>#1:N #2:CCH2</p>	<p>③ CN707-REF-RECHARGE</p> <p>#1:REF-RECHARGEV/V #2:N</p>	<p>④ CN704-HOTGASVALVE1</p> <p>#1:N #2:HOTGAS BYPASS1</p>
<p>⑤ CN705-HOTGASVALVE2</p> <p>#1:HOTGAS BYPASS2 #2:N</p>	<p>⑥ CN711-OIL RETURN VALVE</p> <p>#1:ACCUM OIL RETURN VALVE #2:N</p>	<p>⑦ CN708- 4-WAY VALVE</p> <p>#1:4-WAY VALVE #2:N</p>	<p>⑧ CN70-AC</p> <p>#1:AC #2:AC</p>
<p>⑨ CN701</p> <p>#1:EVIVV 1 #3:EVIVV 2</p>	<p>⑩ CN715-MAIN-COOLING</p> <p>#1:AC #2:AC</p>	<p>⑪ CN705-HOTGAS-BYPASS2</p> <p>#1:AC #2:AC</p>	<p>⑫ CN716-OD-EEV-VALVE</p> <p>#1:AC #2:AC</p>

AC200JXAFNH/AC200JXAPNH

ASSY PCB MAIN-HUB (cont.)

■ DC

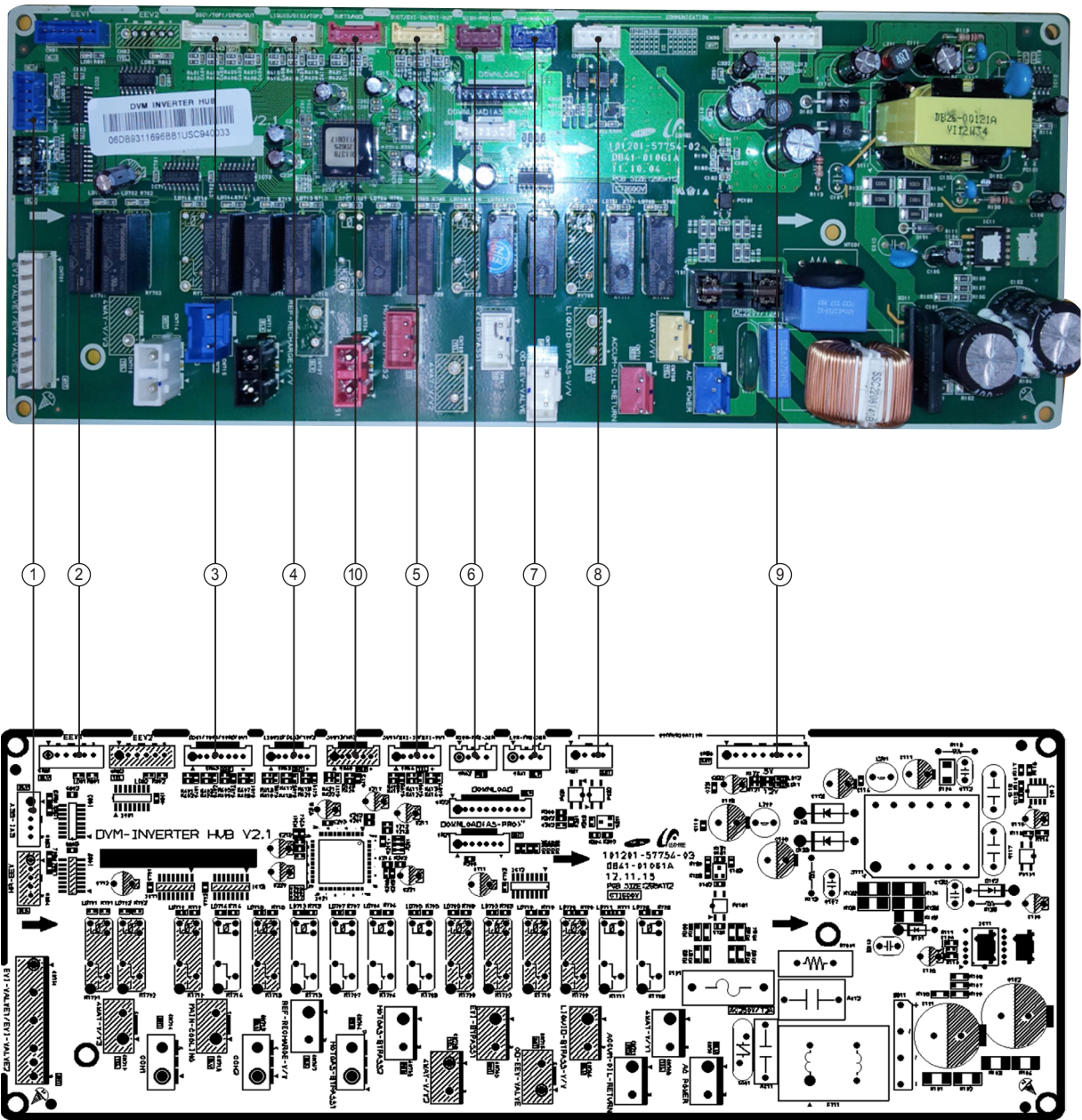

ASSY PCB MAIN-HUB (cont.)

■ DC (cont.)

<p>① CN83-EVI EEV</p> <p>#1:RX-DOWN #2:TX-DOWN #3:N-TRST #4:TDO #5:TCK #6:TDI #7:TMS #8: #9:GND #10:VCC</p>	<p>② CN81-EEV1</p> <p>#1:VCC #2:MODE0 #3:RESET_MAIN #4: #5:F_SCLK #6:F_SDAT #7:GND</p>	<p>③ CN43-TEMP.SENSOR</p> <p>#1:COMP1 DISACHRGE #2:COMP1 DISCHARGE #3:COMP1 TOP #4:COMP1 TOP #5:COND OUT #6:COND OUT #7:OUTDOOR TEMP. #8:OUTDOOR TEMP.</p>	<p>④ CN45-TEMP.SENSOR</p> <p>#1:LIQUID #2:LIQUID #3:COMP2 DISCHARGE #4:COMP2 DISCHARGE #5:COMP2 TOP #6:COMP2 TOP</p>
<p>⑤ CN44-TEMP.SENSOR</p> <p>#1:SUCCTION #2:SUCTION #3:EVI INLET #4:ENI INLET #5:ENI OUT #6:EVI OUT</p>	<p>⑥ CN42I-HIGH PRESSURE SENSOR</p> <p>#1:HIGH PRESSURE SENSOR #3:GND #4:VCC</p>	<p>⑦ CN41-LOW PRESSURE SENSOR</p> <p>#2:LOW PRESSURE SENSOR #3:GND #4:VCC</p>	<p>⑧ CN97-TO FAN COMM.</p> <p>#1:12V #2:INV-SMPS #3:COMM-OUT #4:GND</p>
<p>⑨ CN96-MAIN-HUB COMM.</p> <p>#1:CN12 #2:INV_SMPS_RELAY #3:GOMM-IN #4:GND #5:HIGH-PRESSURE-SENSOR #6:LOW-PRESSURE-SENSOR #7:ZERO-CROSSING #8:GND #9:VCC</p>	<p>⑩ CN46-SUCT</p> <p>#1:SUCT2 #2:SUCT2</p>		

AC200JXAFNH/AC200JXAPNH

ASS'Y PCB INVERTER

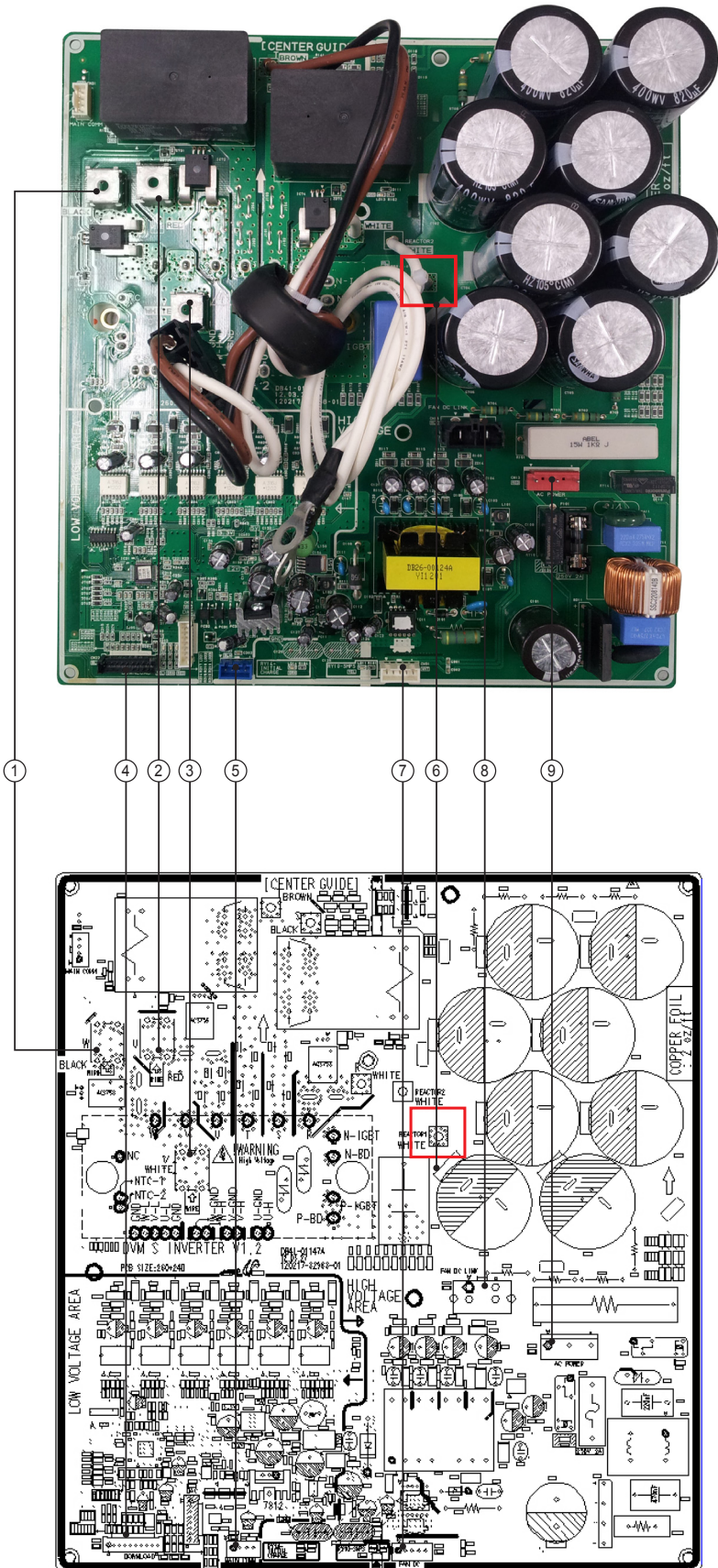

ASSY PCB SUB-DRIVER (cont.)

<p>① W-COMP W</p> <p>#1: COMP W</p>	<p>② U-COMP U</p> <p>#1: COMP U</p>	<p>③ V-COMP V</p> <p>#1: COMP V</p>	<p>④ CN22-DOWNLOAD</p> <p>#1: RX-DOWN #2: TX-DOWN #3: N-TRST #4: TDO #5: TCK #6: TDI #7: TMS #8: #9: GND #10: VCC</p>
<p>⑤ CN32 - MAIN COMM</p> <p>#1: 12V-MAIN #2: IN-SMPS-RELAY #3: COMM-IN #4: GND-MAIN</p>	<p>⑥ REACTOR (WIRE CONNECTION)</p> <p>#1: REACTOR #2: REACTOR</p>	<p>⑦ CN91- FAN DC</p> <p>#1: 18V #2: GND #3: 5V-FAN #4: AD-SELECT</p>	<p>⑧ CN15-FAN DC LINK</p> <p>#1: 500V #2: GND(500V)</p>
<p>⑨ CN13- ACPOWER</p> <p>#1: AC #2: #3: AC</p>			

AC200JXAFNH/AC200JXAPNH

ASS'Y PCB FAN

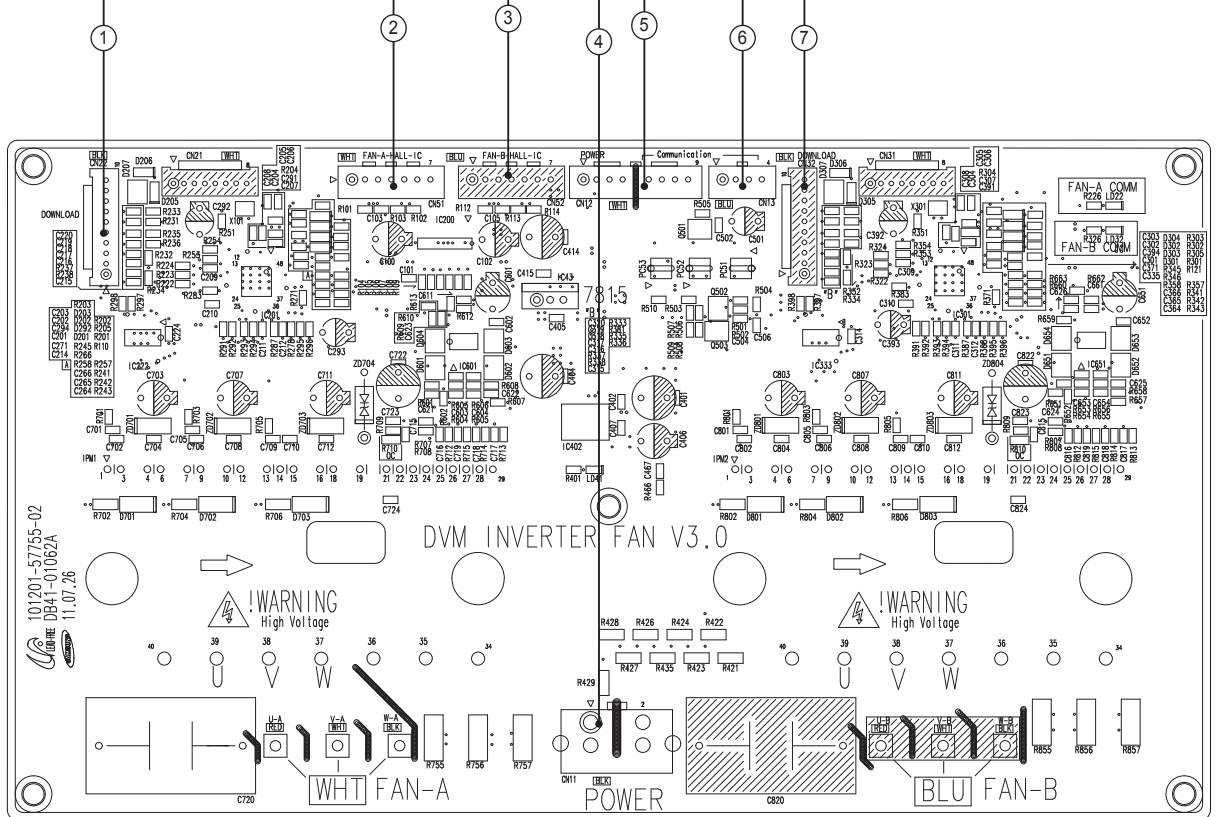
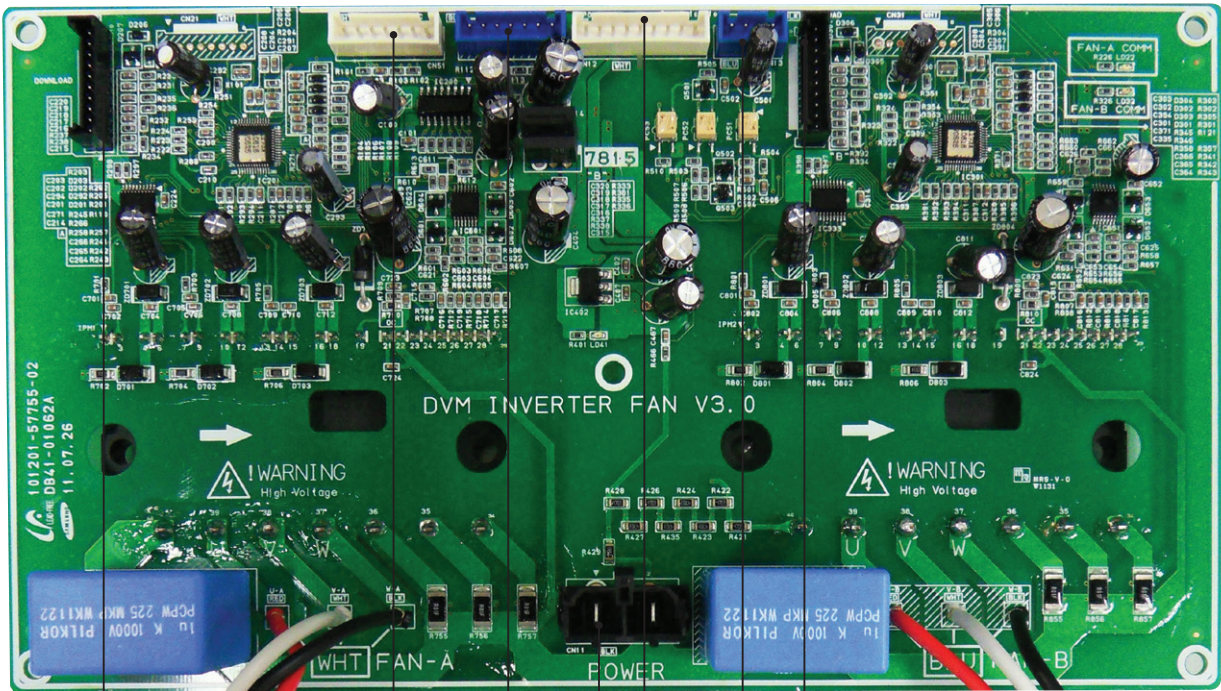

ASS'Y PCB FAN (cont.)

<p>① CN22-DOWNLOAD1</p> <p>#1:RX-DOWN #2:TX-DOWN #3:N-TRST #4:TDO #5:TCK #6:TDI #7:TMS #8: #9:GND #10:VCC</p>	<p>② CN51-FANA-HALL</p> <p>#1:HALL-U #2:5V #3:HALL-V #4:GND #5:HALL-W #6:MT-TEMP #7:GND</p>	<p>③ CN52-FANB_HALL</p> <p>#1:HALL-U #2:5V #3:HALL-V #4:GND #5:HALL-W #6:MT-TEMP #7:GND</p>	<p>④ CN11-POWER</p> <p>#1:500V #2:GND(500V)</p>
<p>⑤ CN12-CONRTOL POWER</p> <p>#1:18V #2:GND #3:COMM-IN #4:GND-MAIN #5: #6:12-MAIN #7:IN-SMPS-RELAY #8:COMM-OUT #9:GND-MAIN</p>	<p>⑥ CN13- COMM</p> <p>#1:12-MAIN #2:IN-SMPS-RELAY #3:COMM-OUT #4:GND-MAIN</p>	<p>⑦ CN32-DOWNLOAD2</p> <p>#1:RX-DOWN #2:TX-DOWN #3:N-TRST #4:TDO #5:TCK #6:TDI #7:TMS #8: #9:GND #10:VCC</p>	

AC200JXAFNH/AC200JXAPNH

ASS'Y PCB EMI

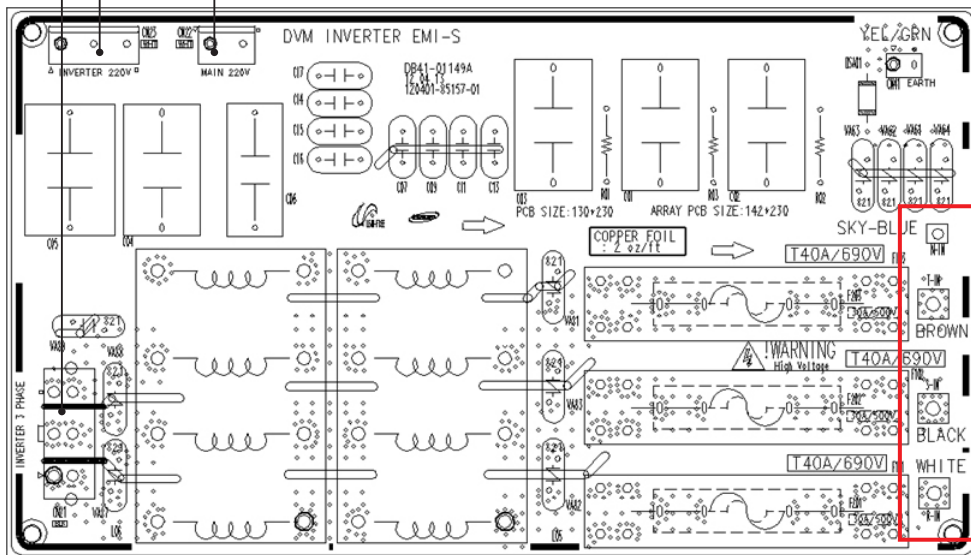
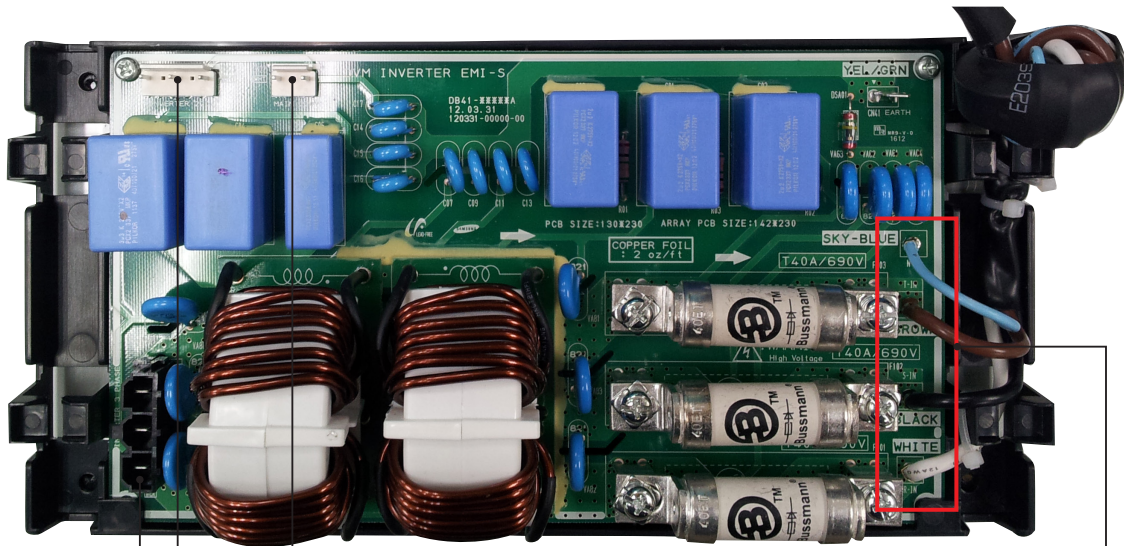

<p>① CN23- INVERTER 220V</p>	<p>② CN21-FAN A</p>	<p>③ CN22-MAIN 220</p>	<p>④ RST-RST INPUT</p>
<p>#1: AC #2: #3: AC</p>	<p>#1: R #2: S #3: T</p>	<p>#1: AC #2: AC</p>	<p>T-IN S-IN R-IN</p>

SUB-COMM

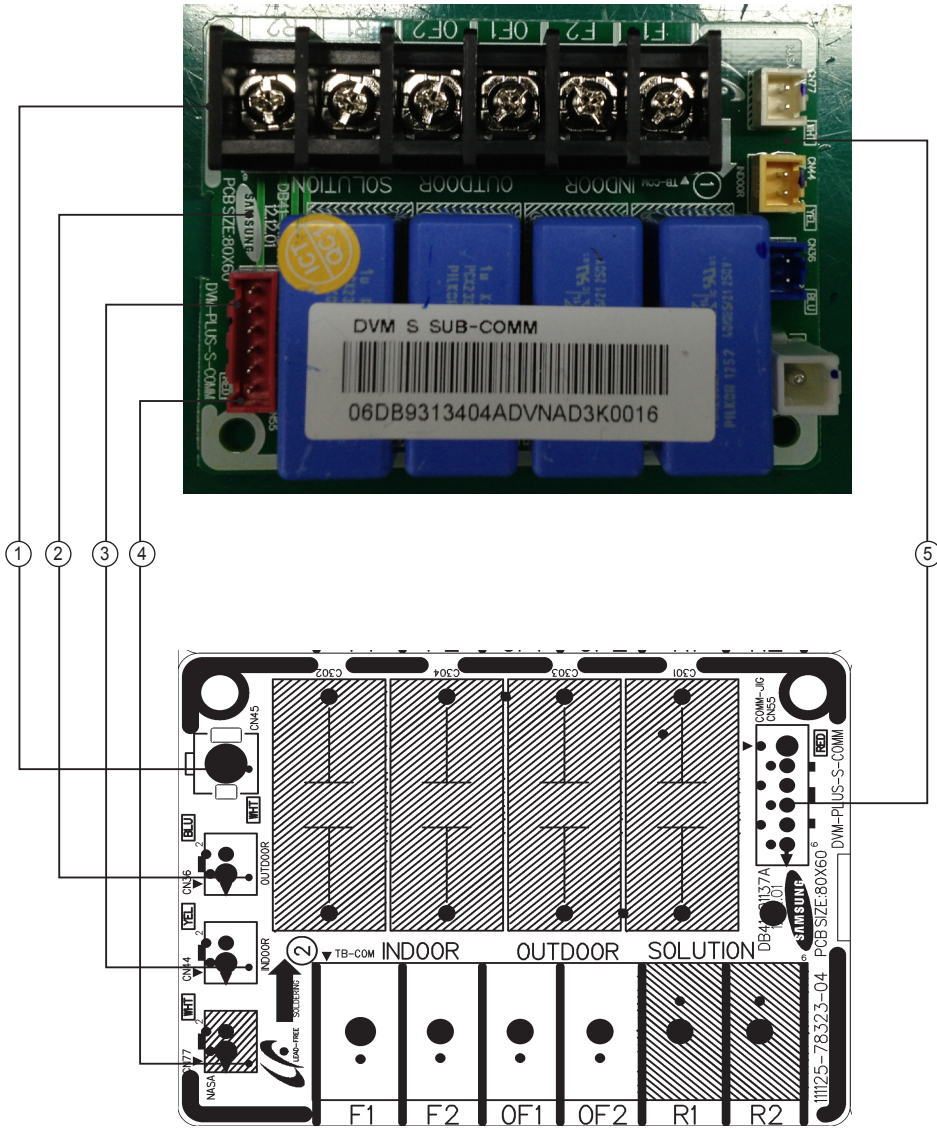

<p>① CN44</p> <p>#1:F1 #2:F2</p>	<p>② CN36</p> <p>#1:OF1 #2:OF2</p>	<p>③ CN#44</p> <p>#1:R1 #2:R2</p>	<p>④ CN45</p> <p>GND</p>	<p>⑤ CN55</p> <p>#1:F1 #2:F2 #3:OF1 #4:OF2 #5:R1 #6:R2</p>
---------------------------------------------	-----------------------------------------------	----------------------------------------------	---------------------------------	---------------------------------------------------------------------------------------

ASSY PCB WATER-HUB

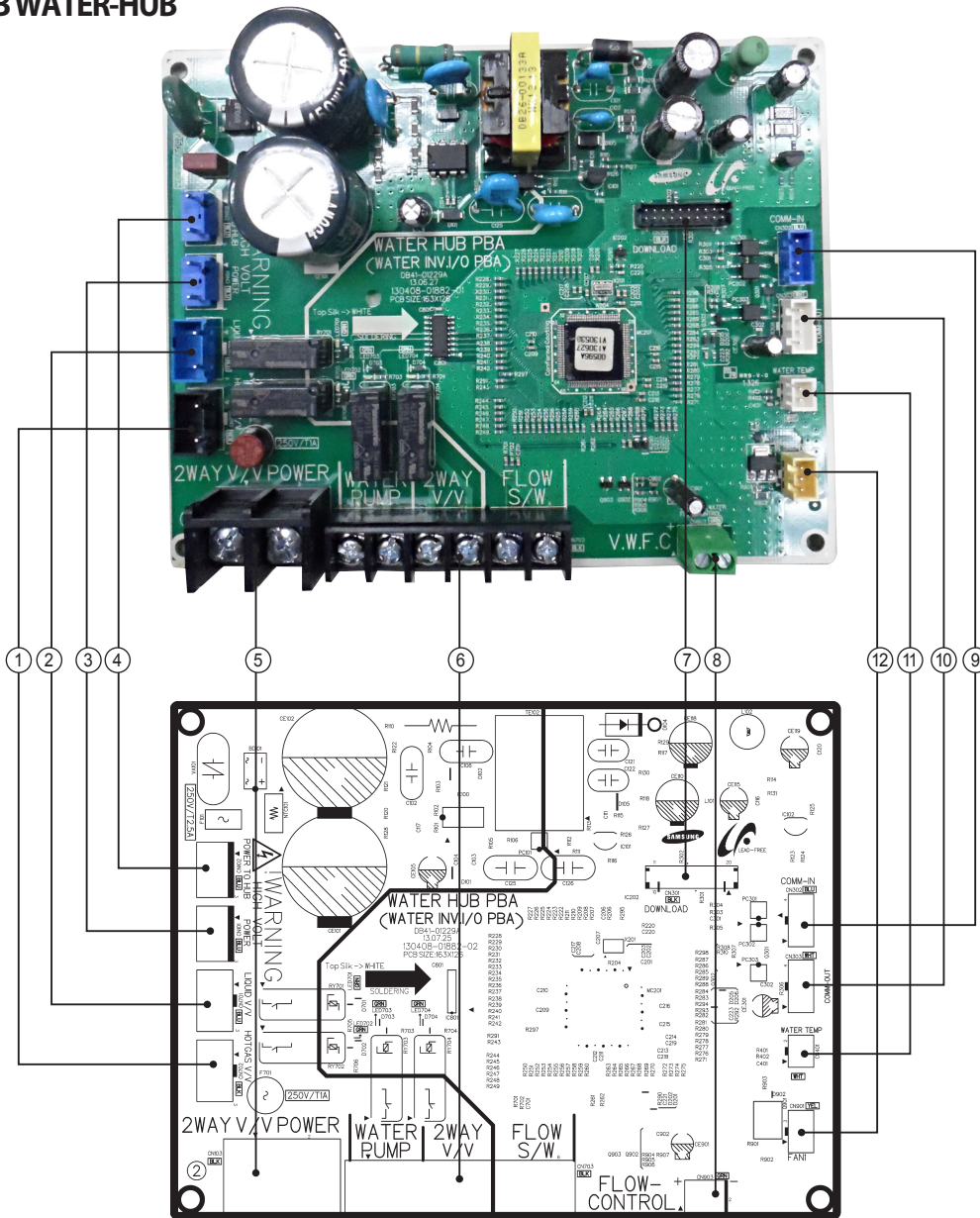

<p>□ CN702-HOT GAS V/V</p> <p>#1:N #3:T</p>	<p>② CN701-LIQUID V/V</p> <p>#1:N #3:T</p>	<p>③ CN101-AC INPUT</p> <p>#1:N #3:T</p>	<p>④ CN102-AC OUTPUT</p> <p>#1:N #3:T</p>
<p>⑤ CN103-2WAY VALVE POWER OUTPUT</p> <p>#1: 12V-MAIN #2: IN-SMPS-RELAY #3: COMM-IN #4: GND-MAIN</p>	<p>⑥ CN703- WATER PUMP/2WAY VALVE/FLOW SW</p> <p>#1: WATER PUMP #2: WATER PUMP #3: 2WAY VALVE #4: 2WAY VALVE #5: FLOW SWITCH #6: GND</p>	<p>⑦ CN304 - MICOM DOWNLOAD</p>	<p>⑧ CN903-WATER FLOW</p> <p>#1:DC OUTPUT #2:GND</p>
<p>⑨ CN302-COMM IN</p> <p>#1: 12V #2: INV SMPS RELAY #3: COMM SIGNAL #4: GND</p>	<p>⑩ CN303-COMM OUT</p> <p>#1: 12V #2: INV SMPS RELAY #3: COMM SIGNAL #4: GND</p>	<p>⑪ CN401-WATER TEMP.</p> <p>#1:TEMP.INPUT #2:GND</p>	<p>⑫ CN901-DC FAN</p> <p>#1:DC 12V OUTPUT #2:FEEDBACK #3:GND</p>

6. Wiring Diagram

6-1 Indoor Unit

AC160JNHFKH/AC180JNHFKH/AC200JNHFKH/AC180JNHPKH/AC200JNHPKH

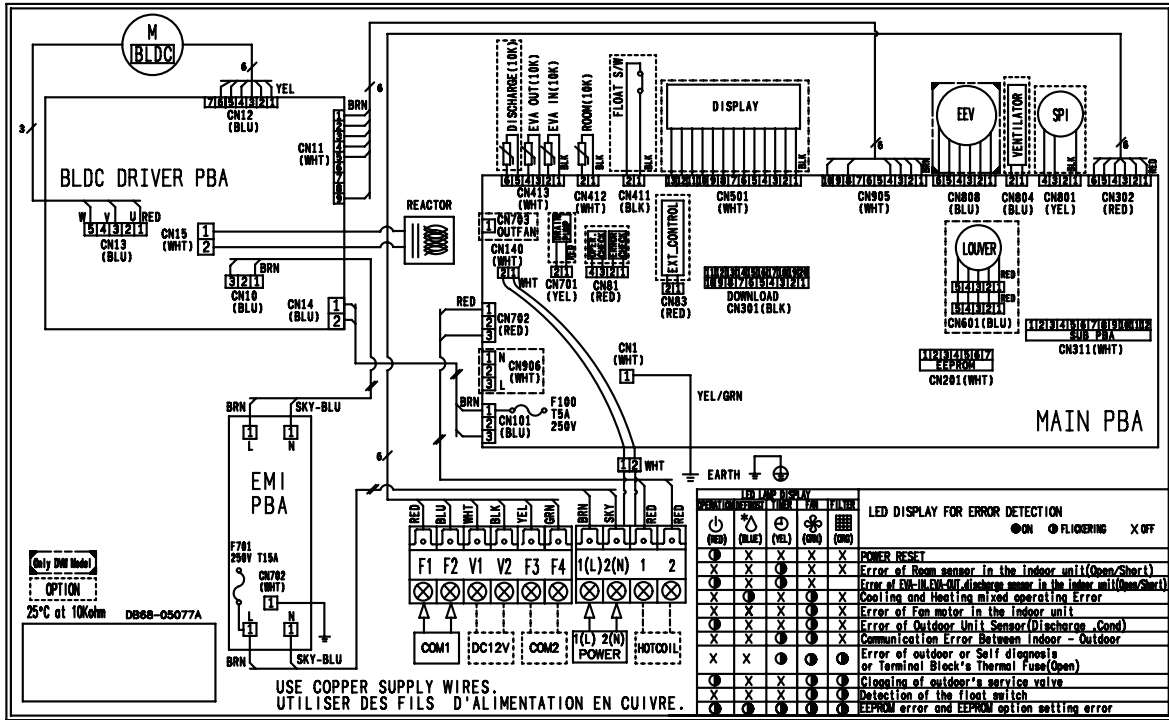

This Document can not be used without Samsung's authorization.

6-2 Outdoor Unit

AC160JXAFKH

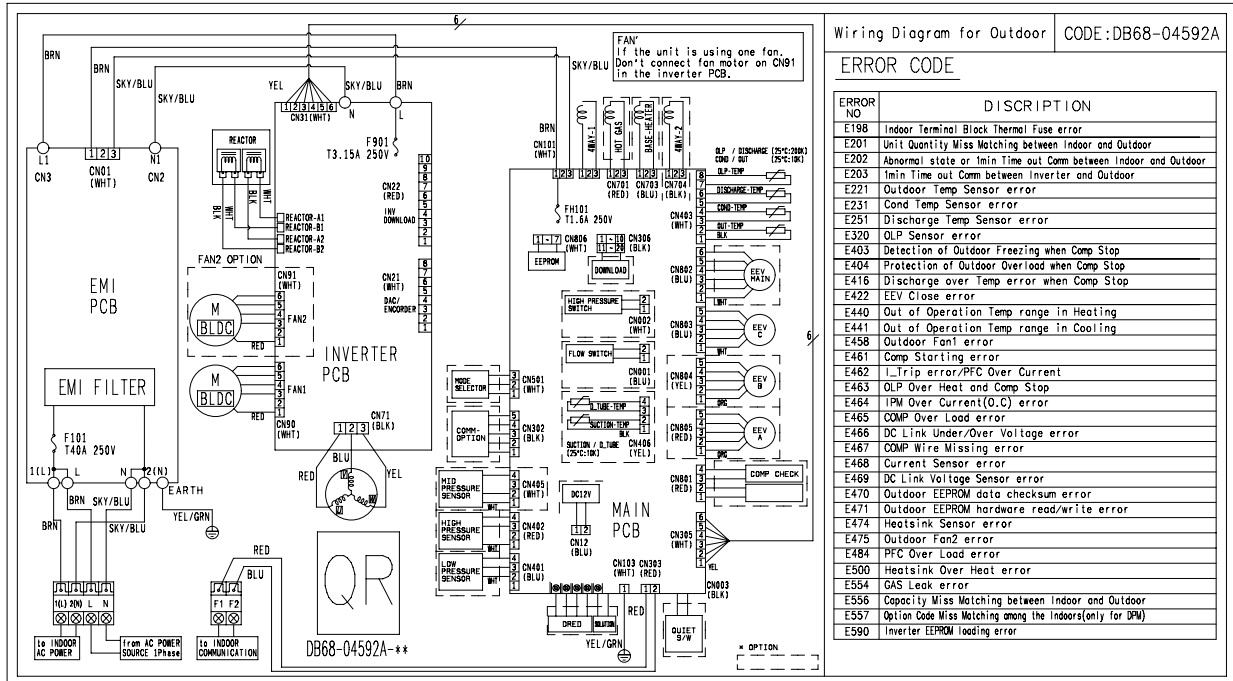

This Document can not be used without Samsung's authorization.

AC160JXAFNH/AC180JXAFNH/AC180JXAPNH

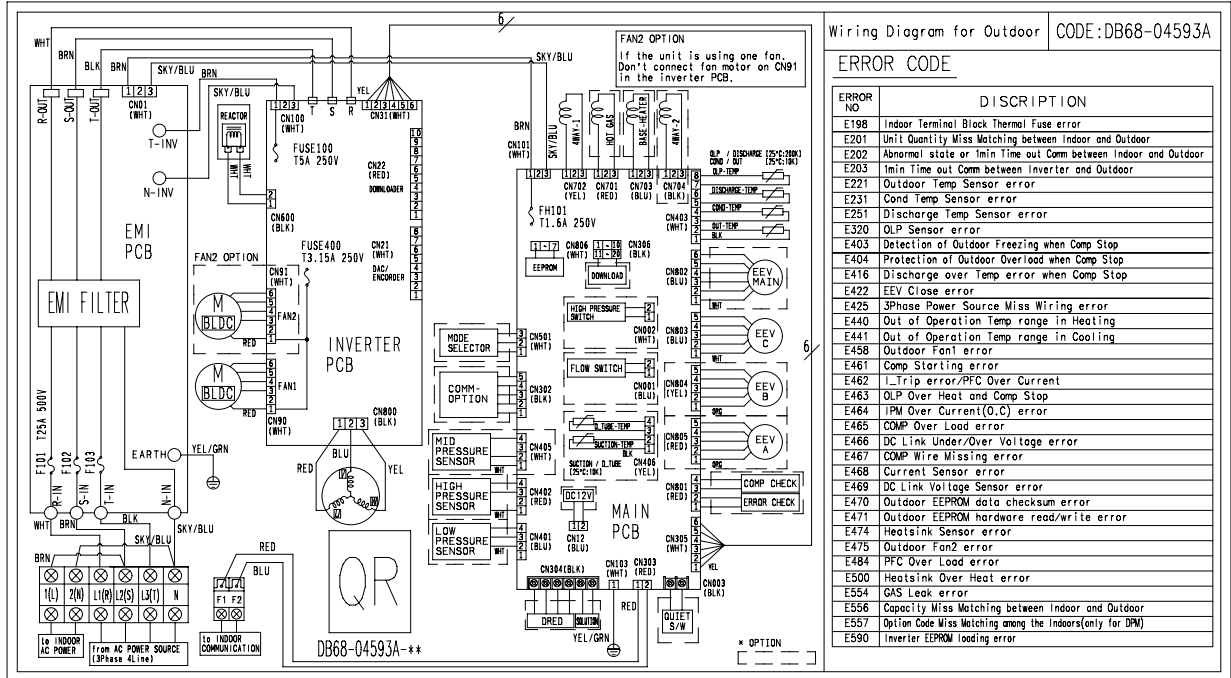

ERROR CODE

ERROR NO	DISCRIPTION
E198	Indoor Terminal Block Thermal Fuse error
E201	Unit Quantity Miss Matching between Indoor and Outdoor
E202	Abnormal state or Tim Time out Comm between Indoor and Outdoor
E203	Tim Time out Comm between Inverter and Outdoor
E221	Outdoor Temp Sensor error
E231	Cond Temp Sensor error
E251	Discharge Temp Sensor error
E320	OLP Sensor error
E403	Detection of Outdoor Freezing when Comp Stop
E404	Protection of Outdoor Overload when Comp Stop
E416	Discharge over Temp error when Comp Stop
E422	EEV Close error
E425	3Phase Power Source Miss Wiring error
E440	Out of Operation Temp range in Heating
E441	Out of Operation Temp range in Cooling
E458	Outdoor Fan1 error
E461	Comp Starting error
E462	I-Trip error/PFC Over Current
E463	OLP Over Heat and Comp Stop
E464	IPM Over Current(O.C) error
E465	COMP Over Load error
E466	DC Link Under/Over Voltage error
E467	COMP Wire Missing error
E468	Current Sensor error
E469	DC Link Voltage Sensor error
E470	Outdoor EEPROM data checksum error
E471	Outdoor EEPROM hardware read/write error
E474	Heatsink Sensor error
E475	Outdoor Fan2 error
E484	PFC Over Load error
E500	Heatsink Over Heat error
E554	GAS Leak error
E556	Capacity Miss Matching between Indoor and Outdoor
E557	Option Code Miss Matching among the Indoors(only for DPM)
E590	Inverter EEPROM loading error

This Document can not be used without Samsung's authorization.

AC200JXAFNH/AC200JXAPNH

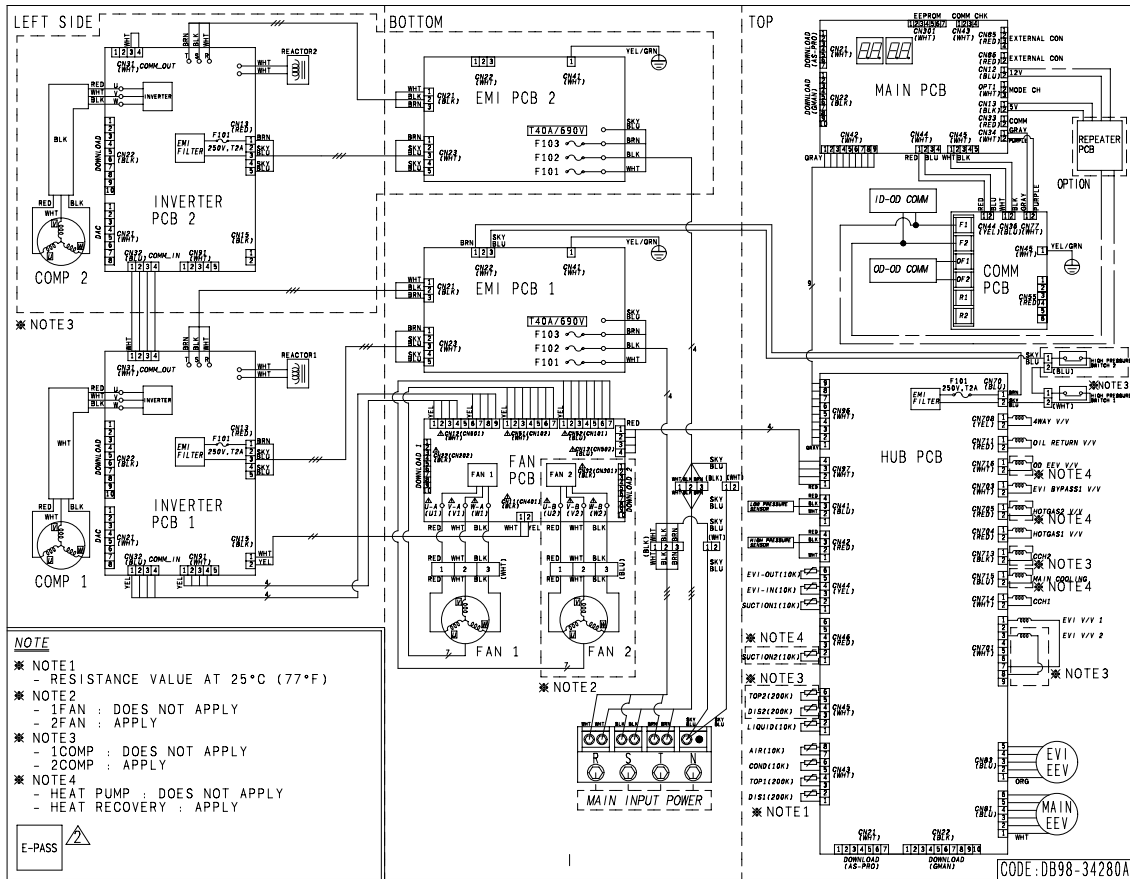

This Document can not be used without Samsung's authorization.

7. Reference Sheet

7-1 Refrigerating Cycle Diagram

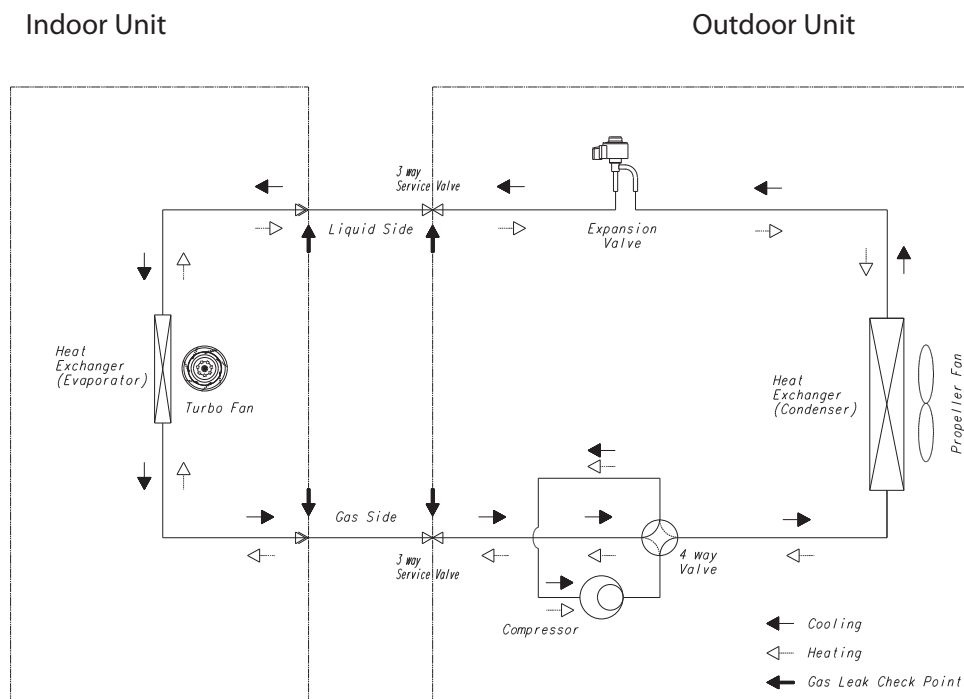

■ CONDENSER

High temperature and high pressure gas state coolant discharged from the compressor is converted to a liquid state as it is cooled down by the heat emission in the outdoor condenser unit, and sent to the evaporator.

■ COMPRESSOR

Low temperature and low pressure coolant is compressed and sent to the cycling system.

■ EVAPORATOR

Liquid coolant sucked in through the capillary tubes cools down the room by absorbing the surrounding heat as it evaporates (converting from liquid to gas). (Absorbing heat required for evaporation)

■ SERVICE VALVE

You can open the valve by turning the need valve counterclockwise using hex wrench, and it is used for vacuum, gas purging, coolant injection, coolant purging, and indoor-outdoor unit connection.

■ ACCUMULATOR

Accumulator prevents the flow of liquid-state coolant into the compressor. (Liquid-state coolant flowing into the compressor will overload the compressor.)

7-2 Index of Model Name

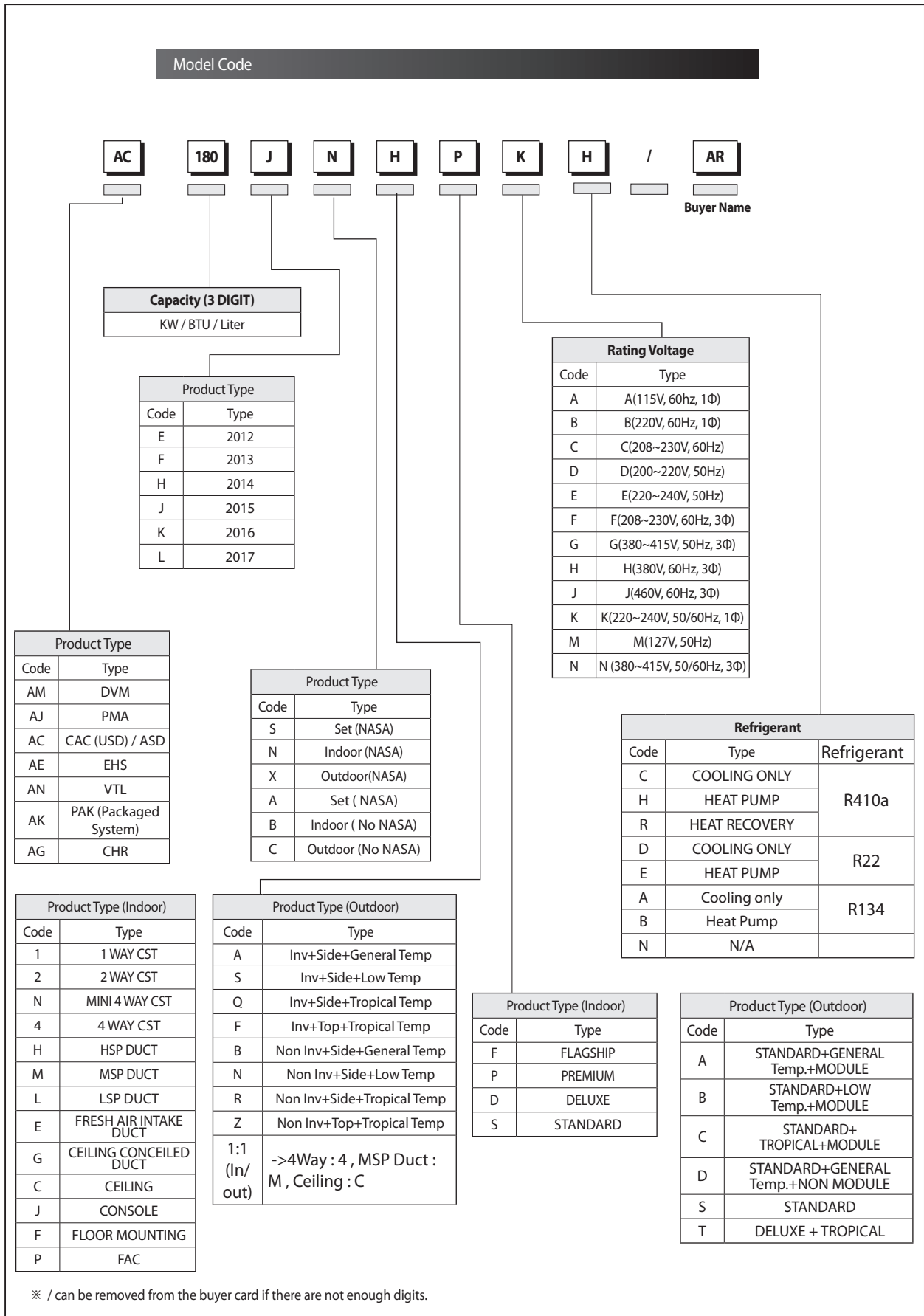



This Service Manual is a property of Samsung Electronics Co., Ltd.
Any unauthorized use of Manual can be punished under applicable
International and/or domestic law.

© Samsung Electronics Co., Ltd Jan. 2015.
Printed in China.
Code No. DB68-00000A (1)
