

Contents

Safety precautions	2
Preparation for installation	4
Deciding on where to install the indoor unit	5
Indoor unit installation	10
Purging the unit	11
Connecting the refrigerant pipe	12
Cutting/Flaring the pipes	13
Performing leak test & insulation	14
Drainpipe and drain hose installation	16
Interface module Installation (Optional)	18
Connecting the connection cord	19
Adjusting air flow	20
Easy Tuning	22
Setting the indoor unit option code	23
Setting an indoor unit address and installation option	24
Troubleshooting	27
How to connect your extended power cables	29

Safety precautions

Carefully follow the precautions listed below because they are essential to guarantee the safety of the equipment.



WARNING

- Always disconnect the air conditioner from the power supply before servicing it or accessing its internal components.
- Verify that installation and testing operations are performed by qualified personnel.
- Verify that the air conditioner is not installed in an easily accessible area.

General information

- ▶ Carefully read the content of this manual before installing the air conditioner and store the manual in a safe place in order to be able to use it as reference after installation.
- ▶ For maximum safety, installers should always carefully read the following warnings.
- ▶ Store the operation and installation manual in a safe location and remember to hand it over to the new owner if the air conditioner is sold or transferred.
- ▶ This manual explains how to install an indoor unit with a split system with two SAMSUNG units. The use of other types of units with different control systems may damage the units and invalidate the warranty. The manufacturer shall not be responsible for damages arising from the use of non compliant units.
- ▶ The manufacturer shall not be responsible for damage originating from unauthorized changes or the improper connection of electric and requirements set forth in the "Operating limits" table, included in the manual, shall immediately invalidate the warranty.
- ▶ The air conditioner should be used only for the applications for which it has been designed: the indoor unit is not suitable to be installed in areas used for laundry.
- ▶ Do not use the units if damaged. If problems occur, switch the unit off and disconnect it from the power supply.
- ▶ In order to prevent electric shocks, fires or injuries, always stop the unit, disable the protection switch and contact SAMSUNG's technical support if the unit produces smoke, if the power cable is hot or damaged or if the unit is very noisy.
- ▶ Always remember to inspect the unit, electric connections, refrigerant tubes and protections regularly. These operations should be performed by qualified personnel only.
- ▶ The unit contains moving parts, which should always be kept out of the reach of children.
- ▶ Do not attempt to repair, move, alter or reinstall the unit. If performed by unauthorized personnel, these operations may cause electric shocks or fires.
- ▶ Do not place containers with liquids or other objects on the unit.
- ▶ All the materials used for the manufacture and packaging of the air conditioner are recyclable.
- ▶ The packing material and exhaust batteries of the remote controller(optional) must be disposed of in accordance with current laws.
- ▶ The air conditioner contains a refrigerant that has to be disposed of as special waste. At the end of its life cycle, the air conditioner must be disposed of in authorized centers or returned to the retailer so that it can be disposed of correctly and safely.

Installing the unit

IMPORTANT: When installing the unit, always remember to connect first the refrigerant tubes, then the electrical lines.

Always disassemble the electric lines before the refrigerant tubes.

- ▶ Upon receipt, inspect the product to verify that it has not been damaged during transport. If the product appears damaged, **DO NOT INSTALL** it and immediately report the damage to the carrier or retailer (if the installer or the authorized technician has collected the material from the retailer.)
- ▶ After completing the installation, always carry out a functional test and provide the instructions on how to operate the air conditioner to the user.
- ▶ Do not use the air conditioner in environments with hazardous substances or close to equipment that release free flames to avoid the occurrence of fires, explosions or injuries.
- ▶ Our units should be installed in compliance with the spaces shown in the installation manual, to ensure accessibility from both sides and allow repairs or maintenance operations to be carried out. The unit's components should be accessible and easy to disassemble without endangering people and objects.

For this reason, when provisions of the installation manual are not complied with, the cost required to access and repair the units (in SAFETY CONDITIONS, as set out in prevailing regulations) with harnesses, ladders, scaffolding or any other elevation system will NOT be considered part of the warranty and will be charged to the end customer.

Power supply line, fuse or circuit breaker

- ▶ Always make sure that the power supply is compliant with current safety standards. Always install the air conditioner in compliance with current local safety standards.
- ▶ Always verify that a suitable grounding connection is available.
- ▶ Verify that the voltage and frequency of the power supply comply with the specifications and that the installed power is sufficient to ensure the operation of any other domestic appliance connected to the same electric lines.
- ▶ Always verify that the cut-off and protection switches are suitably dimensioned.
- ▶ Verify that the air conditioner is connected to the power supply in accordance with the instructions provided in the wiring diagram included in the manual.
- ▶ Always verify that electric connections (cable entry, section of leads, protections...) are compliant with the electric specifications and with the instructions provided in the wiring scheme. Always verify that all connections comply with the standards applicable to the installation of air conditioners.
- ▶ Devices disconnected from the power supply should be completely disconnected in the condition of overvoltage category.



- ◆ Make sure that you earth the cables.
 - Do not connect the earth wire to the gas pipe, water pipe, lighting rod or telephone wire. If earthing is not complete, electric shock or fire may occur.
- ◆ Install the circuit breaker.
 - If the circuit breaker is not installed, electric shock or fire may occur.
- ◆ Make sure that the condensed water dripping from the drain hose runs out properly and safely.
- ◆ Install the power cable and communication cable of the indoor and outdoor unit at least 1m away from the electric appliance.
- ◆ Install the indoor unit away from lighting apparatus using the ballast.
 - If you use the wireless remote controller, reception error may occur due to the ballast of the lighting apparatus.
- ◆ Do not install the air conditioner in following places.
 - Place where there is mineral oil or arsenic acid. Resin parts flame and the accessories may drop or water may leak. The capacity of the heat exchanger may reduce or the air conditioner may be out of order.
 - The place where corrosive gas such as sulfurous acid gas generates from the vent pipe or air outlet. The copper pipe or connection pipe may corrode and refrigerant may leak.
 - The place where there is a machine that generates electromagnetic waves. The air conditioner may not operate normally due to control system.
 - The place where there is a danger of existing combustible gas, carbon fiber or flammable dust. The place where thinner or gasoline is handled. Gas may leak and it may cause fire.

Preparation for installation

When deciding on the location of the air conditioner with the owner, the following restrictions must be taken into account.

General

Do NOT install the air conditioner in a location where it will come into contact with the following elements :

- ◆ Combustible gases
- ◆ Saline air
- ◆ Machine oil
- ◆ Sulphide gas
- ◆ Special environmental conditions







If you must install the unit in such conditions, first consult your dealer.

Avoid installing the air conditioner :

- ◆ In areas where it is exposed to direct sunlight. Close to heat sources.
- ◆ In damp areas or locations where it could come into contact with water. (for example rooms used for laundry)
- ◆ In areas where curtains and furniture could affect the supply and discharge of air.
- ◆ Without leaving the required minimum space around the unit. (as shown in the drawing)
- ◆ In scarcely ventilated areas.
- ◆ On surfaces that are unable to support the weight of the unit without deforming, breaking or causing vibrations during the use of the air conditioner.
- ◆ In a position that does not enable the condensate drainage pipe to be correctly installed. (at the end of the installation. It is always essential to check the efficiency of the drainage system)

Accessories

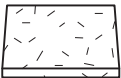
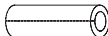
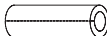
- ◆ The following accessories are supplied with the indoor unit.
The type and quantity may differ depending on the specifications.

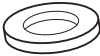
User manual(1) 	Installation manual(1) 	Clamp hose(1) 	Flexible hose (1) 	Insulation drain (1) 
Thermal insulation sponge A (1) 	Thermal insulation sponge B (1) 	Thermal insulation sponge C (1) 	Cable-tie(8) 	Rubber(8) 

Deciding on where to install the indoor unit

Indoor unit

- ◆ There must be no obstacles near the air inlet and outlet.
- ◆ Install the indoor unit on a ceiling that can support its weight.
- ◆ Maintain sufficient clearance around the indoor unit.
- ◆ Make sure that the water dripping from the drain hose runs away correctly and safely.
- ◆ The indoor unit must be installed in this way, that they are out of public access. (Not touchable by the users)
- ◆ After connecting a chamber, insulate the connection part between the indoor unit and the chamber with t10 or thicker insulation. Otherwise, there can be air leak or dew from the connection part.

Space requirements for installation & service

■ Construction Standard for Inspection Hole

- 1) In case, the ceiling is tex tile, Inspection hole dose not need.
- 2) In case, the ceiling is plaster board, Inspection hole depends on Inside height of the ceiling.
 - a. Height is more than 0.5m : Only "B" [Inspection for PBA] is applied.
 - b. Height is less than 0.5m : Both "A"&"B" are applied.
 - c. "A"&"B" are inspection holes .

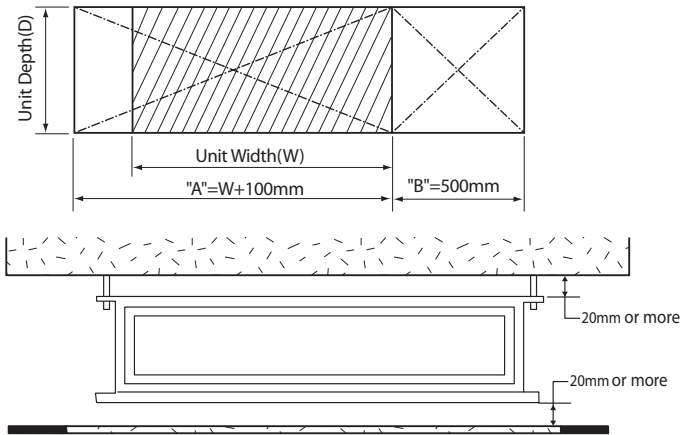

- You must have 20mm or more space between the ceiling and the bottom of indoor unit. Otherwise, the noise from the vibration of indoor unit may bother the user. When the ceiling is under construction, the hole for check-up must be made to take service, clean and repair the unit.
- It is possible to install the unit at an height of between 2.2~2.5m from the ground, if the unit has a duct with a well defined lenght (300mm or more), to avoid fan motor blower contact.
- If you install the cassette or duct type indoor unit on the ceiling with humidity over 80%, you must apply extra 10mm of polyethylene foam or other insulation with similar material on the body of the indoor unit.

Deciding on where to install the indoor unit

Insulation Guide

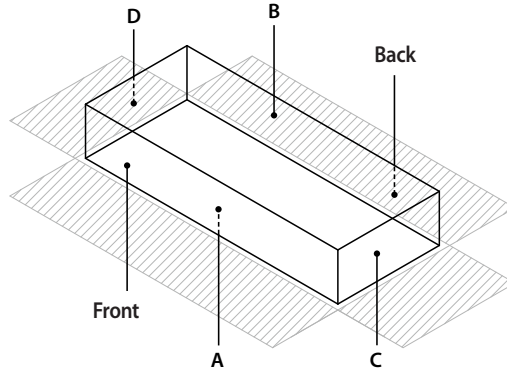

Thickness: more than 10mm

Indoor Unit		A	B	C	D	Front/Back
AC035JNMCEH	850X700X250	850X250	850X250	700x250	700x250	Insulate the front and back side in proper size at the same time when insulating the suction duct and discharge duct.
AC071JNMCEH	1200x700x250	1200x250	1200x250	700x250	700x250	
AC100JNMCEH AC125JNMCEH	1300x700x300	1300x300	1300x300	700x300	700x300	

- ◆ Insulate the end of the pipe and some curved area by using separate insulator.
- ◆ Insulate the discharge and suction part at the same time when you insulate connection duct.

AC035JNMCEH

Unit:mm

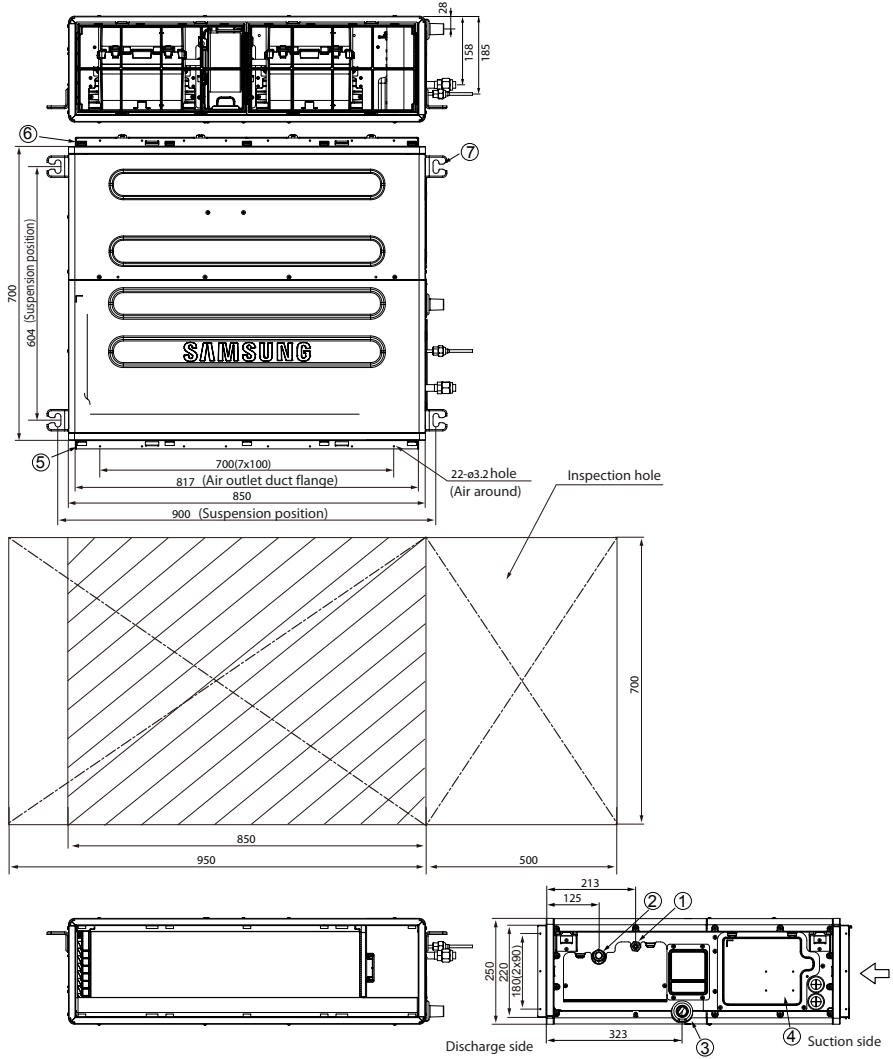

No.	Name	Description
1	Liquid pipe connection	ø6.35(1/4")
2	Gas pipe connection	ø9.52(3/8")
3	Drain pipe connection	OD25 ID20(without drain pump)
4	Power supply connection	
5	Air discharge flange	
6	Air filter	
7	Hook	M8~M10

Deciding on where to install the indoor unit

AC071JNMCEH

Unit:mm

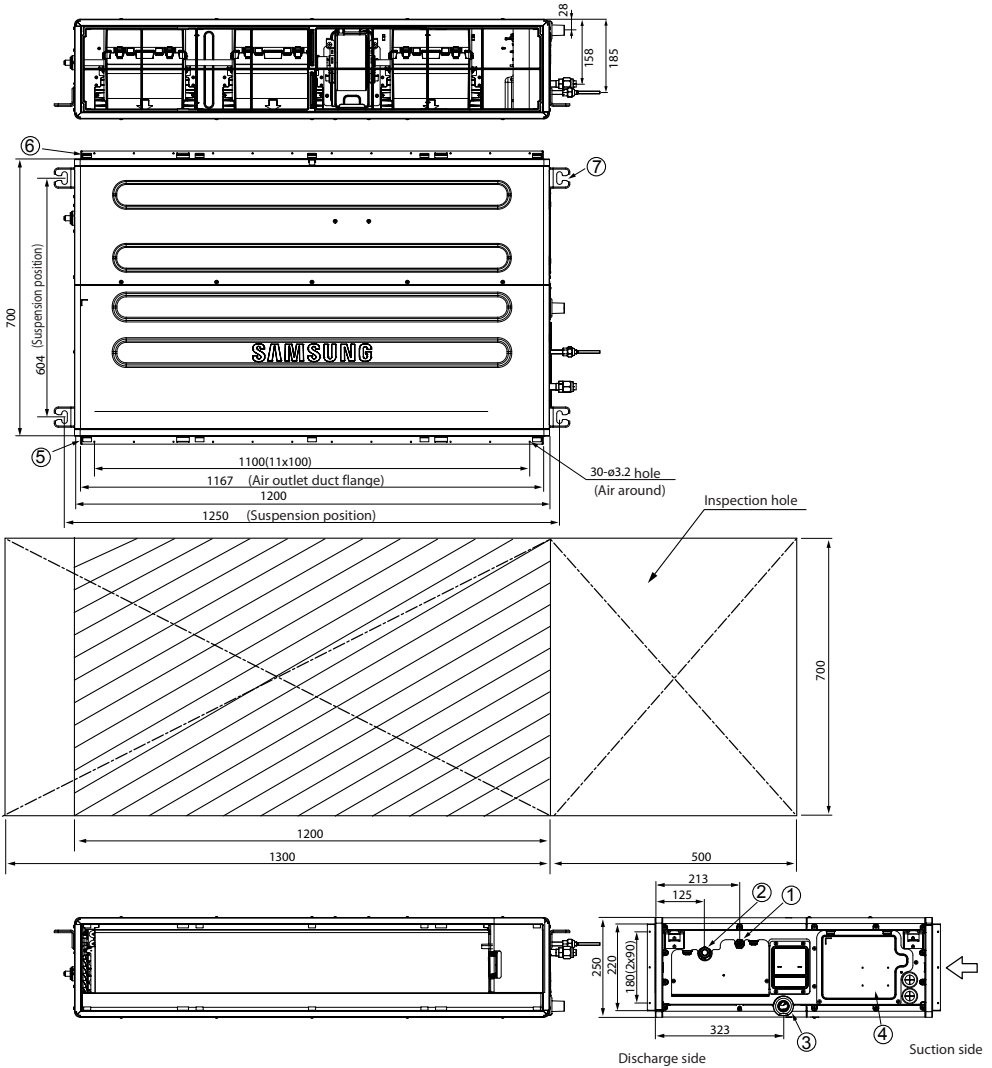

No.	Name	Description
1	Liquid pipe connection	ø9.52(3/8")
2	Gas pipe connection	ø15.88(5/8")
3	Drain pipe connection	OD25 ID20(without drain pump)
4	Power supply connection	
5	Air discharge flange	
6	Air filter	
7	Hook	M8~M10

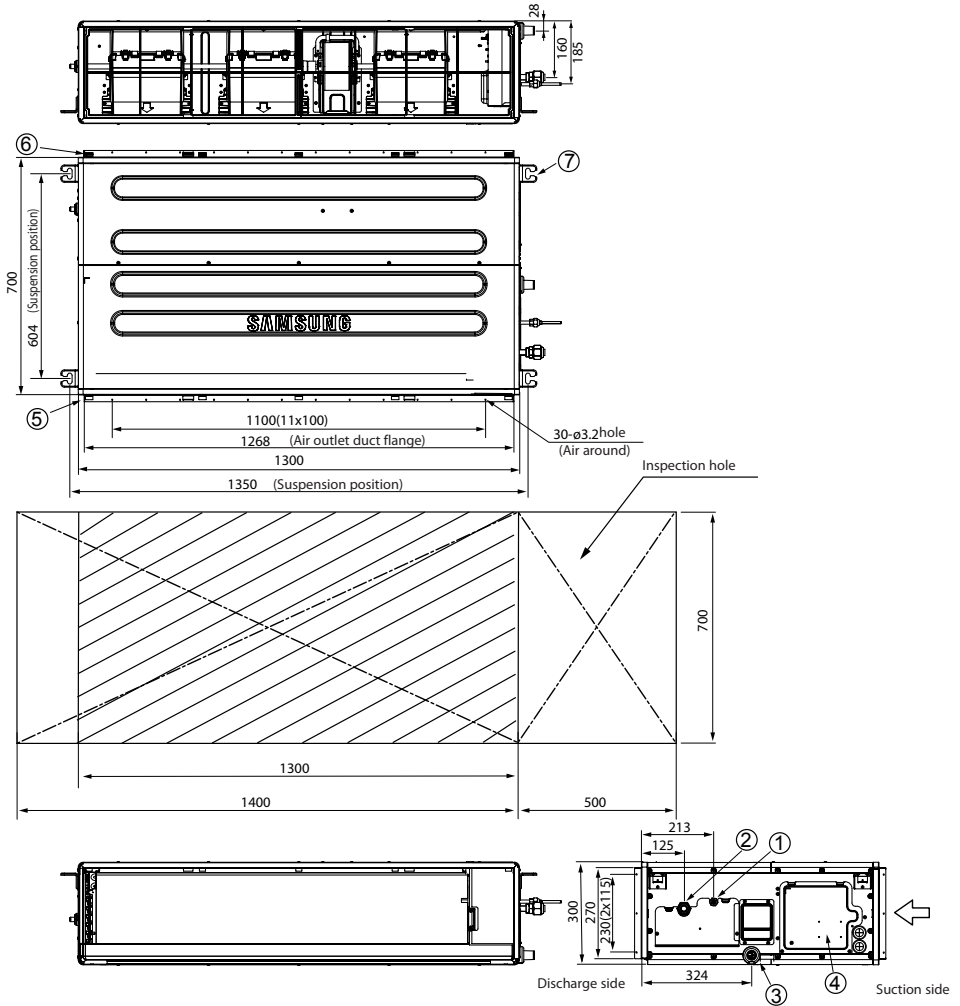

No.	Name	Description
1	Liquid pipe connection	ø9.52(3/8")
2	Gas pipe connection	ø15.88(5/8")
3	Drain pipe connection	OD25 ID20(without drain pump)
4	Power supply connection	
5	Air discharge flange	
6	Air filter	
7	Hook	M8~M10

Indoor unit installation

When deciding on the location of the air conditioner with the owner, the following restrictions must be taken into account.

- 1 Place the pattern sheet on the ceiling at the spot where you want to install the indoor unit.



NOTE

- Since the diagram is made of paper, it may shrink or stretch slightly due to temperature or humidity. For this reason, before drilling the holes maintain the correct dimensions between the markings.

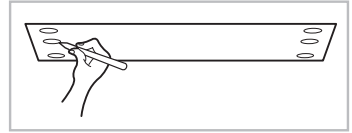

- 2 Insert bolt anchors. Use existing ceiling supports or construct a suitable support as shown in figure.
- 3 Install the suspension bolts depending on the ceiling type.



CAUTION

- Ensure that the ceiling is strong enough to support the weight of the indoor unit. Before hanging the unit, test the strength of each attached suspension bolt.
- If the length of suspension bolt is more than 1.5m, it is required to prevent vibration.
- If this is not possible, create an opening on the false ceiling in order to be able to use it to perform the required operations on the indoor unit.

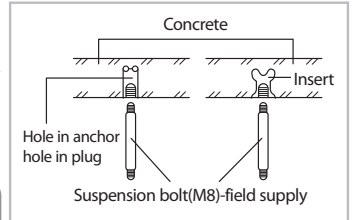

- 4 Screw eight nuts to the suspension bolts making space for hanging the indoor unit.



NOTE

- You must install all the suspension rods.

- 5 Hang the indoor unit to the suspension bolts between two nuts.



CAUTION

- Piping must be laid and connected inside the ceiling when suspending the unit. If the ceiling is already constructed, lay the piping into position for connection to the unit before placing the unit inside the ceiling.

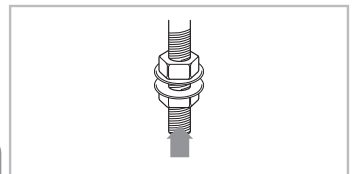
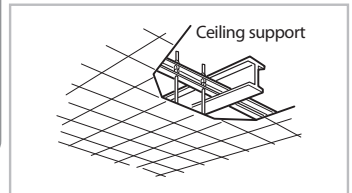

- 6 Screw the nuts to suspend the unit.

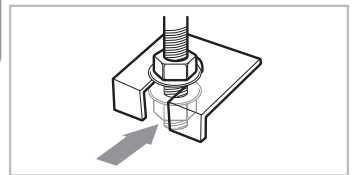

- 7 Adjust level of the unit by using measurement plate for all 4 sides.



CAUTION

- For proper drainage of condensate, give a 3mm slant to the left or right side of the unit which will be connected with the drain hose, as shown in the figure. Make a tilt when you wish to install the drain pump, too.
- When installing the indoor unit, make sure it is not tilted toward front or back side.

When the drain hose is installed to the right.

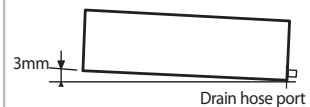

Purging the unit

From factory the unit is supplied and set with a pre-charge of nitrogen gas. (insert gas) Therefore, all insert gas must be purged before connecting the assembly piping.

Unscrew the pinch pipe at the end of each refrigerant pipe.

RESULT : All inert gas escapes from the indoor unit.



NOTE

- To prevent dirt or foreign objects from getting into the pipes during installation, do NOT remove the pinch pipe completely until you are ready to connect the piping.



CAUTION

- Connect the indoor and outdoor units using pipes with flared connections(not supplied). For the lines, use insulated, unwelded, degreased and deoxidized copper pipe (Cu DHP type to ISO 1337 or UNI EN 12735-1), suitable for operating pressures of at least 4200kPa and for a burst pressure of at least 20700kPa. Copper pipe for hydro-sanitary applications is completely unsuitable.
- For sizing and limits (height difference, line length, max. bends, refrigerant charge, etc.) see the outdoor unit installation manual.
- All refrigerant connection must be accessible, in order to permit either unit maintenance or removing it completely.

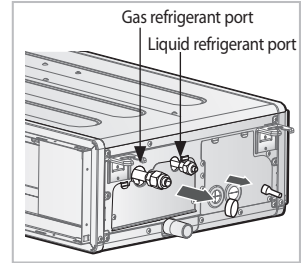

* The designs and shape are subject to change according to the model.

Connecting the refrigerant pipe

There are two refrigerant pipes of different diameters :

- ◆ A smaller one for the liquid refrigerant
- ◆ A larger one for the gas refrigerant
- ◆ The inside of copper pipe must be clean & has no dust

1. Remove the pinch pipe on the pipes and connect the assembly pipes to each pipe, tightening the nuts, first manually and then with a torque wrench, a spanner applying the following torque.

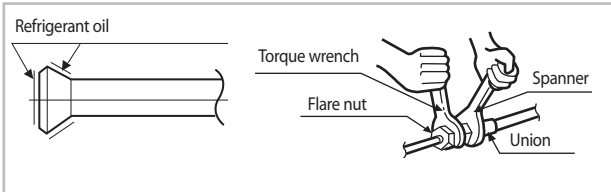

Outer Diameter (D)	Torque (N·m)
ø6.35 mm	14 ~ 18
ø9.52 mm	34 ~ 42
ø12.70 mm	49 ~ 61
ø15.88 mm	68 ~ 82
ø19.05 mm	100 ~ 120



• If the pipes must be shortened refer to page 13.

2. Must use insulator which is thick enough to cover the refrigerant tube to protect the condensate water on the outside of pipe falling onto the floor and the efficiency of the unit will be better.
3. Cut off any excess foam insulation.
4. Be sure that there must be no crack or wave on the bended area.
5. It would be necessary to double the insulation thickness(10mm or more) to prevent condensation even on the insulator when if the installed area is warm and humid.
6. Do not use joints or extensions for the pipes that connect the indoor and outdoor unit. The only permitted connections are those for which the units are designed.

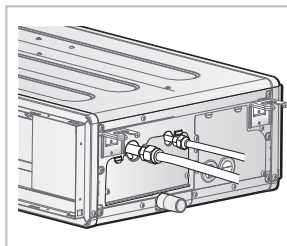
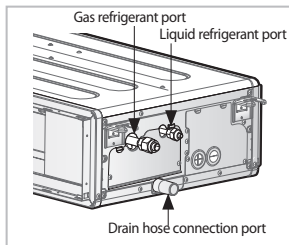

* The designs and shape are subject to change according to the model.

Cutting/Flaring the pipes

1. Make sure that you have the required tools available. (pipe cutter, reamer, flaring tool and pipe holder)
2. If you wish to shorten the pipes, cut it with a pipe cutter, taking care to ensure that the cut edge remains at a 90° angle with the side of the pipe. Refer to the illustrations below for examples of edges cut correctly and incorrectly.

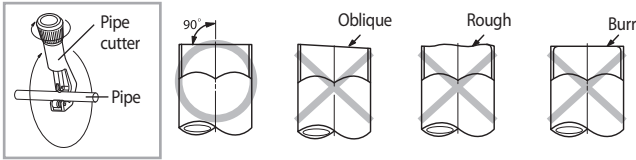

3. To prevent any gas from leaking out, remove all burrs at the cut edge of the pipe, using a reamer.
4. Slide a flare nut on to the pipe and modify the flare.

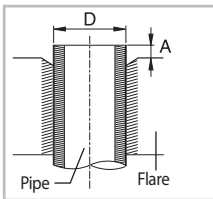

Outer Diameter (D)	Depth (A)
ø6.35 mm	1.3 mm
ø9.52 mm	1.8 mm
ø12.70 mm	2.0 mm
ø15.88 mm	2.2 mm
ø19.05 mm	2.2 mm

5. Check that the flaring is correct, referring to the illustrations below for examples of incorrect flaring.

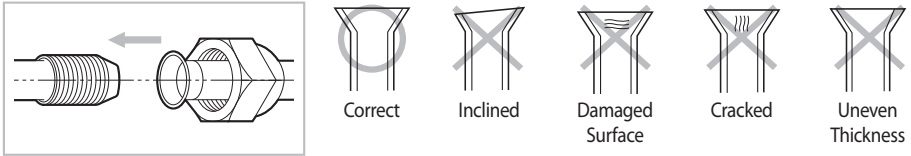

Outer diameter (D,mm)	Connection torque (N·m)	Flare dimension (L,mm)	Flare shape (mm)
Ø 6.35	14~18	8.7~9.1	
Ø 9.52	34~42	12.8~13.2	
Ø 12.70	49~61	16.2~16.6	
Ø 15.88	68~82	19.3~19.7	
Ø 19.05	100~120	23.6~24.0	

CAUTION ⚠ If the pipes require brazing ensure that OFN (Oxygen Free Nitrogen) is flowing through the system.
 • Nitrogen blowing pressure range is 0.02 ~ 0.05MPa.

Performing leak test & insulation

Leak test

◆ LEAK TEST WITH NITROGEN (before opening valves)

In order to detect basic refrigerant leaks, before recreating the vacuum and recirculating the R410A, it's responsible of installer to pressurize the whole system with nitrogen (using a cylinder with pressure reducer) at a pressure above 40 bar (gauge).

◆ LEAK TEST WITH R410A (after opening valves)

Before opening valves, discharge all the nitrogen into the system and create vacuum. After opening valves check leaks using a leak detector for refrigerant R410A.



• Discharge all the nitrogen to create a vacuum and charge the system.

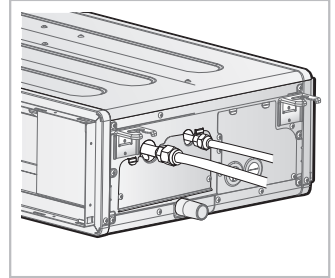

* The designs and shape are subject to change according to the model.

Insulation

Once you have checked that there are no leaks in the system, you can insulate the piping and hose.

- 1 To avoid condensation problems, place T13.0 or thicker Acrylonitrile Butadiene Rubber separately around each refrigerant pipe.



• Always make the seam of pipes face upwards.



• The insulation has to be produced in full compliance of European regulation reg. EEC / EU 2037/ 2000 that requires the use of sheaths insulation form without using CFC and HCFC gases for health and the environment.

- 2 Wind insulating tape around the pipes and drain hose avoiding to compress the insulation too much.
- 3 Finish wrapping insulating tape around the rest of the pipes leading to the outdoor unit.
- 4 The pipes and electrical cables connecting the indoor unit with the outdoor unit must be fixed to the wall with suitable ducts.



• All refrigerant connection must be accessible, in order to permit either unit maintenance or removing it completely.

- 5 Select the insulation of the refrigerant pipe.

- ◆ Insulate the gas side and liquid side pipe referring to the thickness according to the pipe size.
- ◆ Indoor temperature of 30°C and humidity of 85% is the standard condition. If installing in a high humidity condition, use one grade thicker insulator by referring to the table below. If installing in an unfavorable conditions, use thicker one.
- ◆ Insulator's heat-resistance temperature should be more than 120°C.

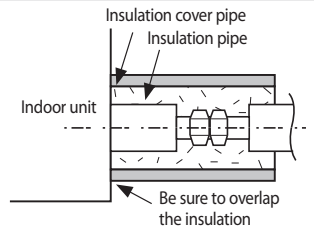
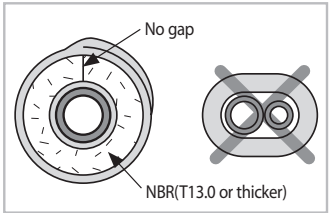

• Must fit tightly against body without any gap.

Pipe	Pipe size	Insulation Type (Heating/Cooling)		Remarks
		Standard [30°C, 85%]	High humidity [30°C, over 85%]	
		EPDM, NBR		
Liquid pipe	Ø6.35 ~ Ø9.52	9t	9t	Internal temperature is higher than 120°C
	Ø12.7 ~ Ø19.05	13t	13t	
Gas pipe	Ø6.35	13t	19t	
	Ø9.52	19t	25t	
	Ø12.70			
	Ø15.88			
	Ø19.05			

◆ When installing insulation in places and conditions below, use the same insulation that is used for high humidity conditions.

<Geological condition>

- High humidity places such as shoreline, hot spring, near lake or river, and ridge (when the part of the building is covered by earth and sand.)

<Operation purpose condition>

- Restaurant ceiling, sauna, swimming pool etc.

<Building construction condition>

- The ceiling frequently exposed to moisture and cooling is not covered.

e.g. The pipe installed at a corridor of a dormitory and studio or near an exit that opens and closes frequently.

- The place where the pipe is installed is highly humid due to the lack of ventilation system.

Drainpipe and drain hose installation

Care must be taken when installing the drain hose for the indoor unit to ensure that any condensate water is correctly drained outside.

The drain hose can be installed to the right of the base pan.

- 1 Installing the drain hose should be the shorter, the better.
 - ◆ In order to discharge condensation water, the drain hose should keep tilted.
 - ◆ Fix the drain hose with Cable-Tie, so that it will not separate from the machine.
 - ◆ While using draining pump, connect the end with draining pump.
- 2 Insulate and fix the drain hose according to the figure.
 - ◆ Insert the drain hose to bottom of the outfall of water basin.
 - ◆ Lock steel ring of the drain hose according to the figure.
 - ◆ Wind and wrap steel ring and drain hose fully with thermal insulation sponge; fix both ends of external layer with ribbon for thermal insulation.
 - ◆ After being installed, drain hose must be insulated fully by heat insulating material. (To be provided at site.)

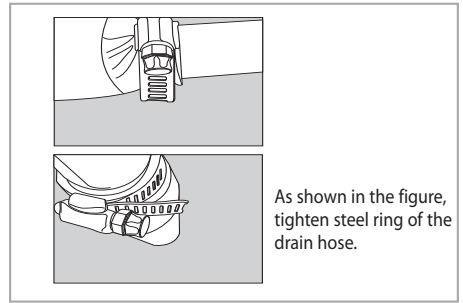
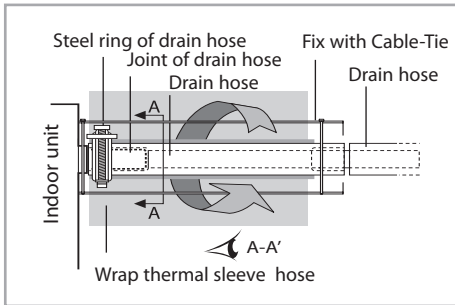

Drainpipe Connection

Without the drain pump

1. Install horizontal drainpipe with a slope of 1/100 or more and fix it by hanger space of 1.0~1.5m.
2. Install U-trap at the end of the drainpipe to prevent a nasty smell to reach the indoor unit.
3. Do not install the drainpipe to upward position. It may cause water flow back to the unit.

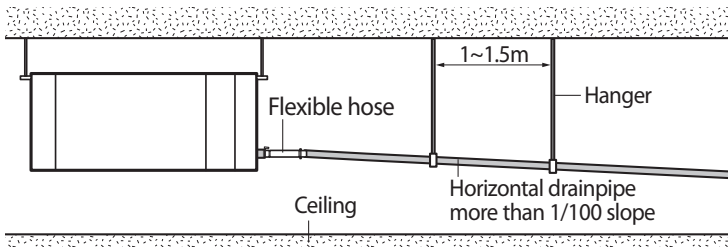

With the drain pump

1. The drain pipe should be installed within 300mm to 550mm from the flexible hose and then lift down 20mm or more.
2. Install horizontal drainpipe with a slope of 1/100 or more and fix it by hanger space of 1.0~1.5m.
3. Install the air vent in the horizontal drainpipe to prevent water flow back to the indoor unit.



NOTE

- You may not need to install it if there were proper slope in the horizontal drainpipe.

4. The flexible hose should not be installed upward position, it may cause water flow back to the indoor unit.

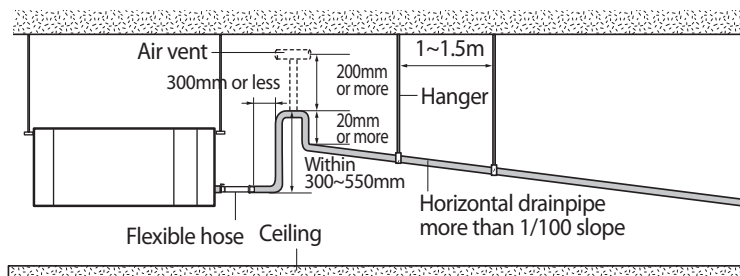

Testing the drainage



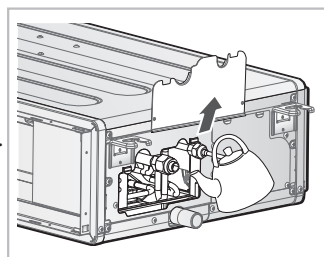

Prepare a little water about 2 liter.

1. Pour water into the base pan in the indoor unit as shown in figure.
2. Confirm that the water flows out through the drain hose.

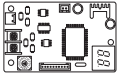

Interface module Installation (Optional)

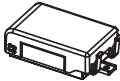
Accessories (Interface module : MIM-N01)

Interface module	DC power cable	Communication cable	PCB Case	Cable-tie
				

1. Fix the case at with bolts on the side of the control box in the indoor unit.(See the picture)
2. Attach the Interface module PCB to the case in the control box of the indoor unit, then connect the power and the communication cable between the Interface module and the indoor unit;
3. If you install a Interface module to an indoor unit, every outdoor unit which is connected to an indoor unit can be controlled simultaneously.
4. Each indoor unit connected to the same centralized controller has its own Interface module.

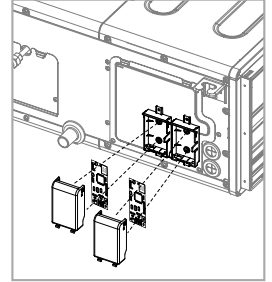

Accessories (SPI module : MSD-EAN1)

Refer to the SPI module(MSD-EAN1) installation manual for the more information.

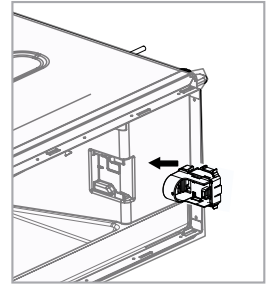

Connecting the connection cord



- Always remember to connect the refrigerant pipes before performing the electric connections. When disconnecting the system, always disconnect the electric cables before disconnecting the refrigerant pipes.
- Always remember to connect the air conditioner to the grounding system before performing the electric connections.

The indoor unit is powered by the outdoor unit by means of a H07 RN-F connection cable (or a more power model), with insulation in synthetic rubber and jacket in polychloroprene(neoprene), in accordance with the requirements of standard EN 60335-2-40.

1. Remove the screw on the electrical component box and remove the cover plate.
2. Route the connection cord through the side of the indoor unit and connect the cable to terminals; refer to the figure below.
3. Route the other end of the cable to the outdoor unit through the ceiling & the hole on the wall.
4. Reassemble the electrical component box cover, carefully tightening the screw.

Wiring diagram

1 phase(*035/071/100*)

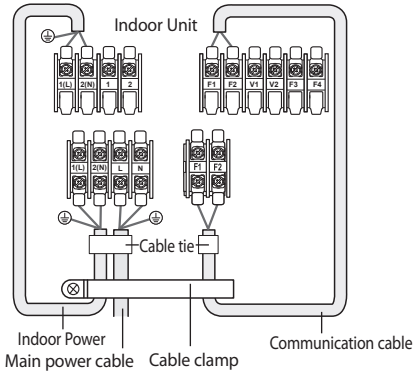

3 phase(*100 /125*)

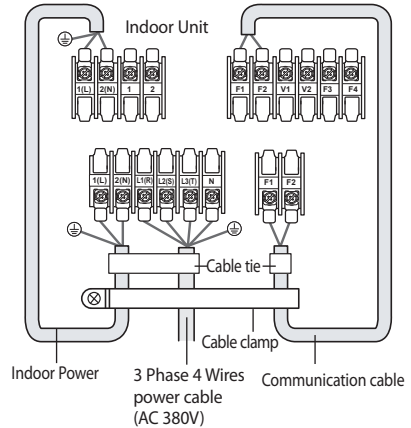

Between Indoor and Outdoor Connection cable Specifications(Common in use)

Indoor Power supply			Communication Cable
Power Supply	Max/Min(V)	Indoor Power cable	
220-240V~/50Hz	±10%	1.5mm ² ↑ ,3wires	0.75~1.25mm ² ,2wires

* Power supply cords of parts of appliances for outdoor use shall not be lighter than polychloroprene sheathed flexible cord. (Code designation IEC:60245 IEC 57 / CENELEC: H05RN-F or IEC:60245 IEC 66 / CENELEC: H07RN-F)

* Screws on terminal block must not be unscrewed with the torque less than 12 kgf·cm.

* Since it has the external power supply, refer to the outdoor unit installation manual for MAIN POWER.

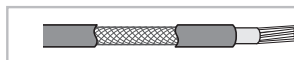

When installing the indoor unit in a computer room, use the double shielded (Tape aluminum / polyester braid + copper) cable of FROHH2R type.

Terminal Block SPEC (Indoor)

AC POWER : M4 SCREW

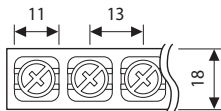

COMMUNICATION : M3.5 SCREW

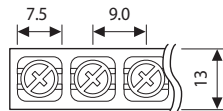

In case of extending the electric wire, please **DO NOT** use a round-shaped pressing socket.

- Incomplete wire connections can cause electric shock or a fire.

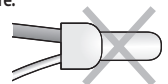

Adjusting air flow

Automatic Air-Volume

When DPM is installed, Automatic Air-Volume function cannot be performed simultaneously for all indoor units. Automatic Air-Volume function must be performed for each indoor unit with the wired remote control attached. With its BLDC motor, you can use smart adjust the indoor unit fan speed depending on the installation condition. If the external static pressure is high so that the duct becomes longer or if the external static pressure is low so that the duct becomes shorter, Using the Automatic Air-Volume function, the volume of exhaust air has been adjusted to the rated volume flow rate automatically.

Performing the Automatic Air-Volume function.

- Check the air conditioning unit stop.

Press the Power button to stop the air conditioner

- Go to Service setting mode with remote controller.

- 1) Press the **Set** and **ESC** buttons at the same time for more than 3 seconds and then a Main menu will be displayed.
- 2) Press the **▲/▼** button to select **8** and then press **▶** button to enter a Sub-menu setting screen.
- 3) Press the **▲/▼** button to select **2** and then press **▶** button to enter a automatic air-volume setting screen.
- 4) Press the **▲/▼** button to select 1 to enable automatic air-volume operation.
- 5) Select mode No. 8.2, and set to "1".
- 6) Press the **▲/▼** button to select 3 and then press **▶** button to enter input voltage.
- 7) Press the **▲/▼** button to select 1~3 to set voltage.

(1 : 220V, 2 : 230V, 3 : 240V)

- 8) Press the **Set** button, then the air conditioning unit will start the fan operation for Automatic Air-Volume adjustment.

* Do not adjust the dampers during fan operation for Automatic Air-Volume adjustment.

- 9) Press **ESC** button to escape setting mode.

(During the automatic air-volume adjustment, [Main Menu] will be displayed **8** → **2** → **1** → **1** repetitively)

- 10) After 1 to 8 minutes, the air conditioning unit stops operating automatically when Automatic Air-Volume adjustment has been carried out (fan operation icon will be off)

- 11) When the air conditioning unit has stopped, check the Mode No. 8.1 is "1" for completion of Automatic Air-Volume.

If the Mode No. 8.1 is "0", Automatic Air-Volume adjustment is fail. Then adjust the fan speed by referring the E. S. P(External Static Pressure) setting table.

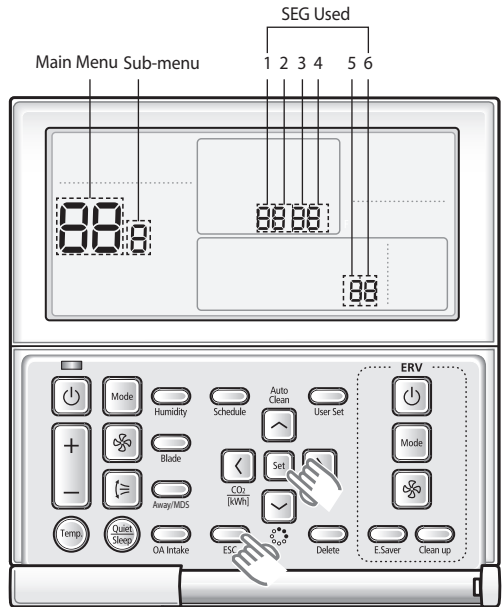

Main menu	Sub menu	Functions	SEG used	Default	Range
8	1	Automatic Air-Volume State Return	1	0	0 - OFF (Fail or Disable) 1 - Completion. 2 - Running Automatic Air-Volume.
	2	Automatic Air-Volume Operation	1	0	0 - Disable 1 - Enable
	3	Automatic Air-Volume Voltage Setting	1	2	1- 220V 2- 230V (Default) 3- 240V When you install the new product, it could display "0"



NOTE

- If the coil is not dry, run the unit for 2 hours with fan only to dry the coil.
- The air filter is properly attached into the air passage on the air suction side of the air conditioning unit.
- Adjust the dampers so that each air inlet and outlet exhausts the designed airflow rate.
- If using booster fans(an outdoor air processing unit or ERV via duct), do not use Automatic Air-Volume function.
- If the duct configurations have been changed, automatic air-volume function perform again.
- The product can be used within the range of rated voltage 220 V/230 V/240 V \pm 5 V. If the product needs to be installed in the condition that is out of the rated voltage stated above, additional setting with installation option is required.

E. S. P(External Static Pressure) setting for phase control motor

With its phase control motor, you can adjust the indoor unit fan speed depending on the installation condition. If the external static pressure is high so that the duct becomes longer or if the external static pressure is low so that the duct becomes shorter, adjust the fan speed by referring the following table.

Model	AC035JNMCEH
Static Pressure(mmAq)	Option code for indoor unit
0 \leq SP \leq 2.5	01B26C-1C5081-27232B-371000
2.5 < SP \leq 5	01B26C-1C50E6-27232B-371000
5 < SP \leq 7.5	01B26C-1C545B-27232B-371000
7.5 < SP \leq 10	01B26C-1C54CF-27232B-371000
10 < SP \leq 12.5	01B26C-1C5933-27232B-371000
12.5 < SP \leq 15	01B26C-1C5987-27232B-371000

Model	AC071JNMCEH
Static Pressure(mmAq)	Option code for indoor unit
0 \leq P \leq 3	01B26C-1C50D5-274750-372020
3 < P \leq 6	01B26C-1C5459-274750-372020
6 < P \leq 8	01B26C-1C54BC-274750-372020
8 < P \leq 10	01B26C-1C54FE-274750-372020
10 < P \leq 12.5	01B26C-1C5942-274750-372020
12.5 < P \leq 15	01B26C-1C5994-274750-372020

Model	AC100JNMCEH
Static Pressure(mmAq)	Option code for indoor unit
0 \leq SP \leq 4	01B26C-1C50F2-276470-375045
4 < SP \leq 8	01B26C-1C5447-276470-375045
8 < SP \leq 12	01B26C-1C54BC-276470-375045
12 < SP \leq 15	01B26C-1C5910-276470-375045

Model	AC125JNMCEH
Static Pressure(mmAq)	Option code for indoor unit
0 \leq P \leq 5.2	01B26C-1C5425-277D8C-374045
5.2 < P \leq 8	01B26C-1C547A-277D8C-374045
8 < SP \leq 12	01B26C-1C54ED-277D8C-374045
12 < SP \leq 15	01B26C-1C5929-277D8C-374045



NOTE

- represents E. S. P(External Static Pressure) range of factory setting. You don't have to adjust the fan speed separately if the external static pressure of the installation place is in . When it is out of , input the appropriate option code.
- If you input the inappropriate option code, error may occur or the air conditioner is out of order. The option code must be inputted correctly by the installation specialist or service agent.

Easy Tuning

EASY Tuning

If the more cooling and heating airflow rate which set up when installing is wanted, or if the more Silent operation which sets up when installing is wanted, air conditioner is tuned for comfort.

Indoor unit airflow rate for high, mid, low mode increases or decreases for +2 ~ -2 Steps with wired remotecon.

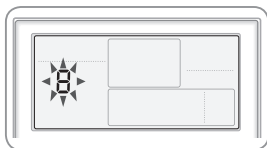

1. Press the User Set button.

▶ (Main Menu) will be displayed, and you can press the [▲]/[▼] buttons to select No. 8, which will set the Easy Tuning.



2. Press the [>] button to select airflow step.

▶ Press the [▲]/[▼] buttons to select airflow step(-2,-1,0,1,2) tuning (During the Easy Tuning setting, AC Fan Speed icon will be displayed)



3) Press the [Set] button to complete the Easy Tuning.

(When the Easy Tuning setting complete, AC Fan Speed icon will be off)

4) Press the [ESC] button to to exit to normal mode.

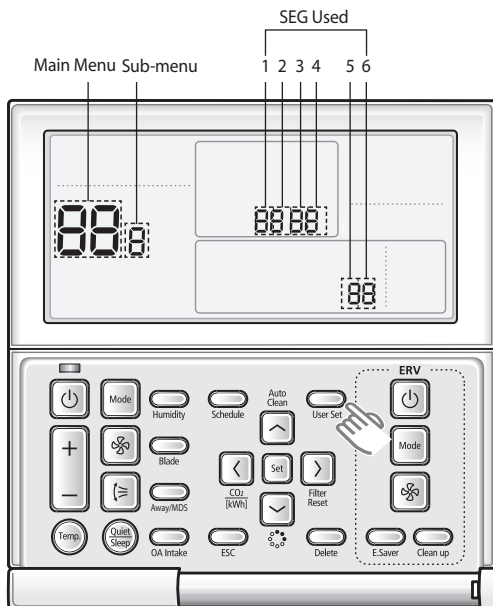

Main menu	Sub menu	Functions	SEG used	Default	Range
8	-	Easy Tuning	1,2	0	-2: -2 Step -1: -1 Step 0: No Use 1: +1 Step 2: +2 Step



NOTE

- Press the [ESC] button anytime during setup to exit without setting.
- According to airflow changed from the Easy Tuning, Air conditioning performance reducing is possible.

Setting the indoor unit option code

In order to set the indoor unit option code use the wired remote controller and follow the directions below.

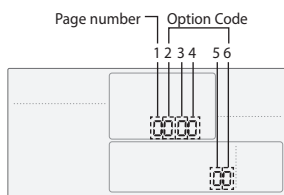
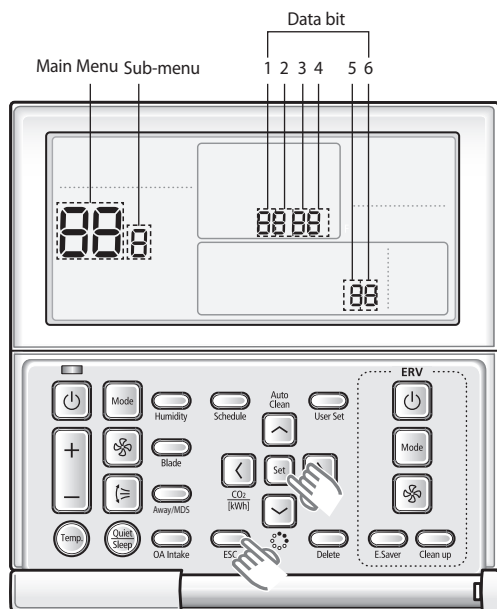

SEG1	SEG2	SEG3	SEG4	SEG5	SEG6
0	*	*	*	*	*

Page number

SEG7	SEG8	SEG9	SEG10	SEG11	SEG12
1	*	*	*	*	*

Page number

SEG13	SEG14	SEG15	SEG16	SEG17	SEG18
2	*	*	*	*	*

Page number

SEG19	SEG20	SEG21	SEG22	SEG23	SEG24
3	*	*	*	*	*

Page number

- 1) Press the **Set** and **ESC** buttons at the same time for more than 3 seconds and then a Main menu will be displayed.
- 2) Press the **Up/Down** button to select **4** and then press **Right** button to enter a Sub-menu setting screen.
- 3) Press the **Up/Down** button to select **2** and then press **Right** button to enter a Indoor unit option code setting screen.



- The first digit represents the page number and the remaining five digits are option codes.
- The option code which is currently setting will flicker.

- 4) Press the **Up/Down** button to set the option code in order. Press **Right** button to go to the next page.
- 5) Press the **Set** button to save and complete the option setting.
- 6) Press the **ESC** button to exit to normal mode.



- Press the **ESC** button anytime during setup to exit without setting.



- Option code will not be applied if you don't press the **Set**
- Setting indoor unit option code is only possible in Master wired remote controller. You can only check the indoor unit option code in Slave wired remote controller.
- Setting indoor unit option code is possible when one indoor unit is connected. If more than 2 indoor units are connected, you can only check the Master indoor unit option code.

Setting an indoor unit address and installation option

Set the indoor unit address and installation option with remote controller option. Set the each option separately since you cannot set the ADDRESS setting and indoor unit installation setting option at the same time. You need to set twice when setting indoor unit address and installation option.

Setting an indoor unit address

- 1) Press the **Set** and **ESC** buttons at the same time for more than 3 seconds and then a Main menu will be displayed.
- 2) Press the **↶**/**↷** button to select **4** and then press **↵** button to enter a Sub-menu setting screen.
- 3) Press the **↶**/**↷** button to select **!** and then press **↵** button to enter a Indoor Address setting screen.

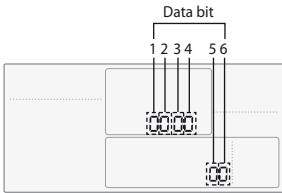

NOTE

- The Main/RMC Address which is currently setting will flicker.
- Data bit 1 and 2 present Indoor unit main address checking
- Data bit 3 and 4 present Indoor unit main address setting(outdoor unit reset is needed to set).
- Data bit 5 and 6 present Indoor unit RMC address setting/checking.

- 4) Press the **↶**/**↷** button to set the Indoor unit Main/RMC Address.
- 5) Press the **Set** button to save and complete the option setting.
- 6) Press the **ESC** button to exit to normal mode.









NOTE

- Press the **ESC** button anytime during setup to exit without setting.
- Address will not be applied if you don't press **Set** button.
- Setting Main/RMC Address of an Indoor unit is available only with a master wired remote controller.

Setting an indoor unit installation option



In order to check and set the indoor unit installation option code use the wired remote controller and follow the directions below.

- 1) Press the  and  buttons at the same time for more than 3 seconds and then a Main menu will be displayed.
- 2) Press the  button to select **4** and then press  button to enter a Sub-menu setting screen.
- 3) Press the  button to select **3** and then press  button to enter a Indoor unit installation option code setting screen.



NOTE

- The first digit represents the page number and the remaining five digits are installation option.
- The total option codes are 24 digits. You can set six digits at a time and it is distinguished by page number (0, 1, 2, 3).

- 4) Press the  button to set the installation option code in order. Press  button to go to the next page.

SEG1	SEG2	SEG3	SEG4	SEG5	SEG6
0	2	RESERVED	Exterior temperature sensor	Central control	RESERVED
SEG7	SEG8	SEG9	SEG10	SEG11	SEG12
1	Drain pump	Use of Hot Coil	RESERVED	RESERVED	RESERVED
SEG13	SEG14	SEG15	SEG16	SEG17	SEG18
2	External control	External control output	S-Plasma ion	Buzzer	Number of hours using filter
SEG19	SEG20	SEG21	SEG22	SEG23	-
3	Individual control of a remote controller	Heating setting compensation	RESERVED	Away Set OFF Timer	-

Setting an indoor unit address and installation option



Option No. : 02XXXX-1XXXXX-2XXXXX-3XXXXX

Option	SEG1		SEG2		SEG3		SEG4		SEG5		SEG6	
Explanation	PAGE		MODE		RESERVED		Use of external temperature sensor		Use of central control		RESERVED	
Indication and Details	Indication	Details	Indication	Details			Indication	Details	Indication	Details		
	0		2				0	Disuse	0	Disuse		
					1	Use	1	Use				
Option	SEG7		SEG8		SEG9		SEG10		SEG11		SEG12	
Explanation	PAGE		Use of drain pump		Use of Hot Coil		RESERVED		RESERVED		RESERVED	
Indication and Details	Indication	Details	Indication	Details	Indication	Details						
	1		0	Disuse	0	Disuse						
			1	Use	1	Use						
			2	Use + 3minute delay	-	-						
Option	SEG13		SEG14		SEG15		SEG16		SEG17		SEG18	
Explanation	PAGE		Use of external control		Setting the output of external control		S-Plasma ion		Buzzer control		Number of hours using filter	
Indication and Details	Indication	Details	Indication	Details	Indication	Details	Indication	Details	Indication	Details	Indication	Details
	2		0	Disuse	0	Thermo on	0	Disuse	0	Use of buzzer	2	1000 Hour
			1	ON/OFF Control	1	Operation on	1	Use	1	Non use of buzzer	6	2000 Hour
			2	OFF Control								
3			WINDOW ON/OFF Control									
Option	SEG19		SEG20		SEG21		SEG22		SEG23		-	
Explanation	PAGE		control of a remote controller		Heating setting compensation		RESERVED		Away Set OFF Timer		-	
Indication and Details	Indication	Details	Indication	Details	Indication	Details			Indication	Details		
	3		0 or 1	Indoor 1	0	Disuse			0 or 1	Auto Set OFF 30Min.		
			2	Indoor 2	1	2°C			2	Auto Set OFF 60Min.		
			3	Indoor 3	2	5°C	3	Auto Set OFF 120Min.				
4	Indoor 4	4	Auto Set OFF 180Min.									

5. Press the  button to save and complete the option setting.

6. Press the  button to exit to normal mode.



























- Press  button anytime during setup to exit without setting.
- Option code will not be applied if you don't press  button.
- Setting Installation option code is available only with a master wired remote controller.
- Setting Installation option code is available when there is one on one connection between a wired remote controller and an indoor unit.

Troubleshooting

- ◆ If an error occurs during the operation, one or more LED flickers and the operation is stopped except the LED.
- ◆ If you re-operate the air conditioner, it operates normally at first, then detect an error again.

LED Display on the receiver & display unit

<u>Abnormal conditions</u>	Indicators					<u>Remarks</u>
	Concealed Type					
	Green	Red				
	Standard Type					
						
Power reset		X	X	X	X	
Error of Room sensor in the indoor unit(Open/Short)	X	X		X	X	
Error of EVA-IN,EVA-OUT sensor in the indoor unit(Open/Short)		X		X	X	
Error of Fan motor in the indoor unit	X	X	X		X	
Error of Outdoor or Terminal Block Thermal Fuse(Open)	X	X				
Clogging of outdoor's service valve		X	X			
Detection of the float switch	X	X	X			
Error of EEPROM or OPTION SETTING						
1. No communication for 2 minutes between indoor units (Communication error for more than 2 minutes) 2. Indoor unit receiving the communication error from outdoor unit 3. Outdoor unit tracking 3 minutes error 4. When sending the communication error from the outdoor unit, the mismatching of the communication numbers and installed numbers after completion of tracking. (Communication error for more than 2 minutes)	X	X			X	1. Indoor unit error (Display is unrelated with operation) 2. Outdoor unit error (Display is unrelated with operation)

● On ◐ Flickering X Off

- ◆ If you turn off the air conditioner when the LED is flickering, the LED is also turned off.

Troubleshooting





Wired remote controller

- ◆ If an error occurs,  is displayed on the wired remote controller. If you would like to see an error code, press the Test button.

Display	Explanation	Remark
102	Communication Error between indoor and outdoor unit	
121	Error of Room sensor in the indoor unit(Open/Short)	
122	Error of Eva In sensor in the indoor unit(Open/Short)	
123	Error of Eva Out sensor in the indoor unit(Open/Short)	
153	2nd Detection of the float switch	
154	Error of Fan motor in the indoor unit	
162	EEPROM error	
163	EEPROM option setting error	
198	Error of Terminal Block's Thermal Fuse(Open)	
202	No communication for 2minutes between indoor units(Communication error for more than 2minutes)	
422	Clogging of outdoor's service valve	
557	Option code miss matching among the indoors (only for DPM)	Check indoor option code
601	Error of communication down between the indoor unit and wired remote controller after 3minutes.	Wired remote controller error
604	Error of communication down between the indoor unit and wired remote controller after completion of 10 times tracking.	
606	COM1/COM2 Cross-installed error	
607	Error of master wired remote controller and slave wired remote controller setting	

How to connect your extended power cables

1) Prepare a compressor and the following tools.

Tools	Crimping pliers	Connection sleeve (mm)	Insulation tape	Contraction tube (mm)
Spec	MH-14	20xØ6.5(HxOD)	Width 19mm	70xØ8.0(LxOD)
Shape				

2) As shown in the figure, peel off the shields from the rubber or wire of the power cable.

- Peel off 20 mm of the wire shields of the tube installed already.

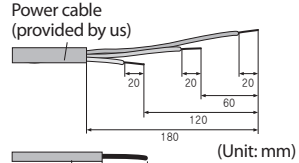

 After peeling off the tube wire, you must insert a contraction tube.

CAUTION For information about the power cable specifications for indoor and outdoor units, refer to the installation manual.

Wire tube power cable

3) Insert both sides of core wire of the power cable into the connection sleeve.

► **Method 1**

Push the core wire into the sleeve from both sides.

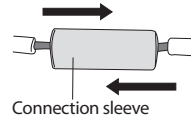

► **Method 2**

Twist the wire cores together and push it into the sleeve.

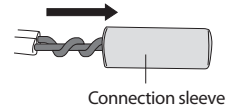

4) Using a compressor, compress the two points and flip it over and compress another two points in the same location.

- The compression dimension should be 8.0.

- After compressing it, pull both sides of the wire to make sure it is firmly pressed.

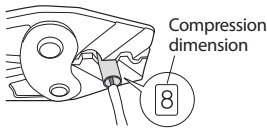

► **Method 1**

Compress it 4 times.

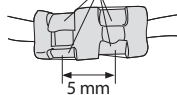

► **Method 2**

Compress it 4 times.

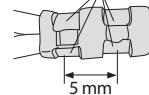

How to connect your extended power cables

- 5) Wrap it with the insulation tape twice or more and position your contraction tube in the middle of the insulation tape.

A total of three or more layers of insulation is required.

► Method 1

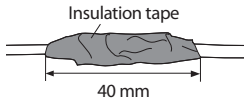

► Method 2

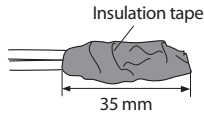

- 6) Apply heat to the contraction tube to contract it.

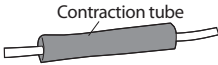

- 7) After tube contraction work is completed, wrap it with the insulation tape to finish.



- Make sure that the connection parts are not exposed to outside.
- Be sure to use insulation tape and a contraction tube made of approved reinforced insulating materials that have the same level of withstand voltage with the power cable. (Comply with the local regulations on extensions.)

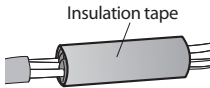

- In case of extending the electric wire, please **DO NOT** use a round-shaped Pressing socket.
- Incomplete wire connections can cause electric shock or a fire.

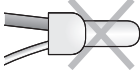

SAMSUNG



Duct Type Series
AC***JNMCEH

Air Conditioner installation manual

imagine the possibilities

Thank you for purchasing this Samsung product.



EN NO SV DA FI ET DE DB68-05399A-02

SAMSUNG