

ERV

Technical Data Book

ERV for Europe (NASA, 50Hz, 60Hz)

SAMSUNG

Index

1 Nomenclature

2 Specifications

3 Fan Characteristics

4 Dimensional drawing

5 Electrical wiring diagram

6 Sound pressure level

1 Nomenclature

Indoor Units

Model Names

AN

(1)

050

(2)

J

(3)

S

(4)

K

(5)

L

(6)

K

(7)

N

(8)

/

EU

Buyer

(1) Classification

AN	VTL
----	-----

(2) Capacity

Air Volume (CMH)

(3) Year

F	2013
H	2014
J	2015

(4) Product Type

S	Set (NASA)
A	Set (no NASA)

(5) Feature1

K	FLAT(CEILING TYPE)_VTL
S	STAND(EXPOSURE TYPE)_VTL

(6) Feature2

L	COMMERCIAL/HIGH VTL
M	COMMERCIAL/STANDARD

(7) Rating Voltag

K	1Ø, 220~240V, 50/60Hz
E	1Ø, 220~240V, 50Hz
G	3Ø, 380~415V, 50Hz

(8) Mode

N	N/A
C	Cooling Only
H	Heat Pump

2 Specifications

ERV

Type			ERV	ERV	ERV	
Model Name			AN026JSKLNVEU	AN035JSKLNVEU	AN050JSKLNVEU	
Power Supply		Φ, #, V, Hz	1,2,220-240,50/60	1,2,220-240,50/60	1,2,220-240,50/60	
Mode		-	Temperature Exchange	Temperature Exchange	Temperature Exchange	
Performance	Air Volume	CMH	260	350	500	
Power Input	Turbo	W	115	115	175	
		High	W	80	80	120
		Low	W	45	50	65
Current		Turbo	A	0.70	0.70	1.10
Fan	Air Flow Rate	Turbo	CMH	260	350	500
		High	CMH	250	350	500
		Low	CMH	180	256	360
	External Static Pressure	Turbo	Pa	100	155	165
		High	Pa	65	100	100
		Low	Pa	55	83	85
Temperature Exchange Efficiency	Cooling	Turbo	%	70.00	70.00	70.00
		High	%	70.00	70.00	70.00
		Low	%	74.00	74.00	74.00
	Heating	Turbo	%	70.00	70.00	70.00
		High	%	70.00	70.00	70.00
		Low	%	74.00	74.00	74.00
Effective Enthalpy Exchange Efficiency	Cooling	Turbo	%	50.00	50.00	50.00
		High	%	50.00	50.00	50.00
		Low	%	55.00	55.00	55.00
	Heating	Turbo	%	70.00	70.00	70.00
		High	%	70.00	70.00	70.00
		Low	%	76.00	76.00	76.00
Field Wiring	Power Source Wire		mm ²	1.5~2.5	1.5~2.5	1.5~2.5
	Transmission Cable		mm ²	0.75~1.5	0.75~1.5	0.75~1.5
Net Weight		kg	28.50	42.50	42.50	
Gross Weight		kg	32.50	53.50	53.50	
Duct Size		mm	150.00	200.00	200.00	
Net Dimensions (WxHxD)		mm	600 x 350 x 660	1012 x 270 x 1000	1012 x 270 x 1000	
Gross Dimensions (WxHxD)		mm	760 x 400 x 807	1299 x 337 x 1183	1299 x 337 x 1183	

- Specifications may be subject to change without prior notice.

- Air Volume/ External Static Pressure, Comply with KS Heat Exhaust Ventilation System Standards(KS B6879).

- Heat Exchange/Temperature Exchange Efficiency, Comply with regulations to promote high efficiency energy devices,
[Cooling], Indoor(24°C DB/17°C WB), Outdoor(35°C DB/24°C WB)
[Heating], Indoor(22°C DB/13.9°C WB), Outdoor(2°C DB/0.44°C WB)

- Sound level was acquired in an anechoic room. Thus actual noise level may be different depending on the installation conditions.

- These products contain R410A which is fluorinated greenhouse gas.

2 Specifications

ERV

Type			ERV	ERV	
Model Name			AN080.JSKLKN/EU	AN100.JSKLKN/EU	
Power Supply		Φ, #, V, Hz	1,2,220-240,50/60	1,2,220-240,50/60	
Mode		-	Temperature Exchange	Temperature Exchange	
Performance	Air Volume	CMH	800	1000	
Power Input	Turbo	W	330	450	
	High	W	230	280	
	Low	W	125	155	
Current	Turbo	A	2.10	2.90	
Fan	Air Flow Rate	Turbo	CMH	800	1000
		High	CMH	800	1000
		Low	CMH	560	690
	External Static Pressure	Turbo	Pa	155	155
		High	Pa	90	90
		Low	Pa	80	75
Temperature Exchange Efficiency	Cooling	Turbo	%	70.00	70.00
		High	%	70.00	70.00
		Low	%	74.00	74.00
	Heating	Turbo	%	70.00	70.00
		High	%	70.00	70.00
		Low	%	74.00	74.00
Effective Enthalpy Exchange Efficiency	Cooling	Turbo	%	50.00	50.00
		High	%	50.00	50.00
		Low	%	55.00	55.00
	Heating	Turbo	%	70.00	70.00
		High	%	70.00	70.00
		Low	%	76.00	76.00
Field Wiring	Power Source Wire	mm ²	1.5~2.5	1.5~2.5	
	Transmission Cable	mm ²	0.75~1.5	0.75~1.5	
Net Weight		kg	67.00	67.00	
Gross Weight		kg	75.50	75.50	
Duct Size		mm	250.00	250.00	
Net Dimensions (WxHxD)		mm	1220 x 340 x 1135	1220 x 340 x 1135	
Gross Dimensions (WxHxD)		mm	1299 x 400 x 1183	1299 x 400 x 1183	

- Specifications may be subject to change without prior notice.

- Air Volume/ External Static Pressure, Comply with KS Heat Exhaust Ventilation System Standards(KS B6879).

- Heat Exchange/Temperature Exchange Efficiency, Comply with regulations to promote high efficiency energy devices,
[Cooling], Indoor(24°C DB/17°C WB), Outdoor(35°C DB/24°C WB)
[Heating], Indoor(22°C DB/13.9°C WB), Outdoor(2°C DB/0.44°C WB)

- Sound level was acquired in an anechoic room. Thus actual noise level may be different depending on the installation conditions.

- These products contain R410A which is fluorinated greenhouse gas.

3 Fan Characteristics

AN026JSKLN

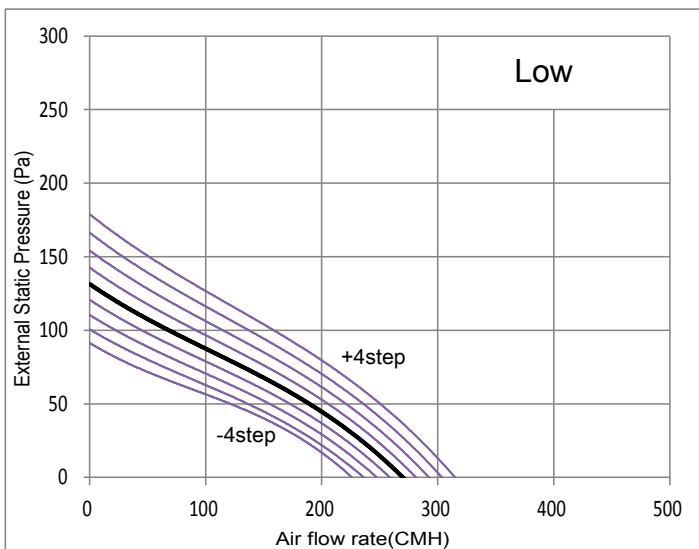
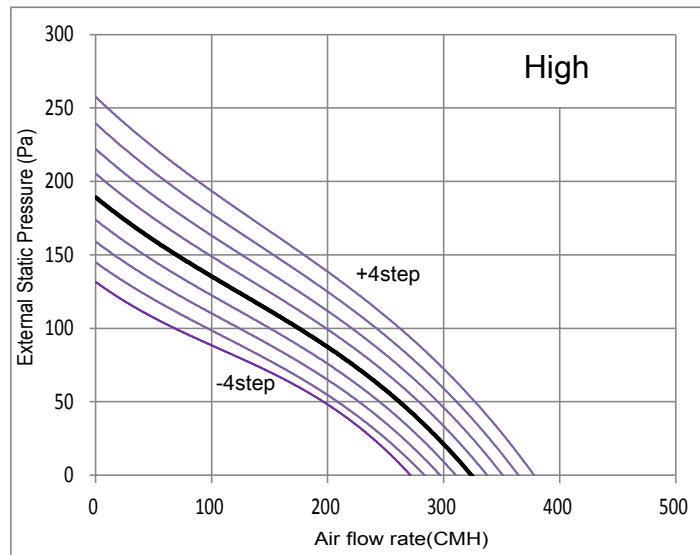
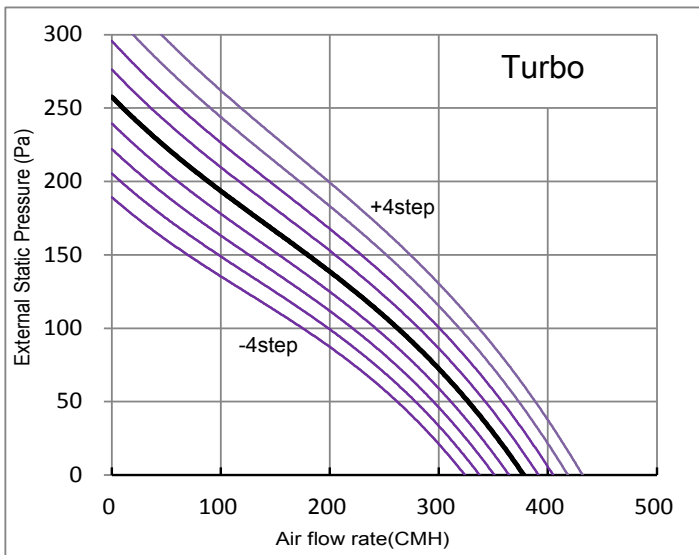
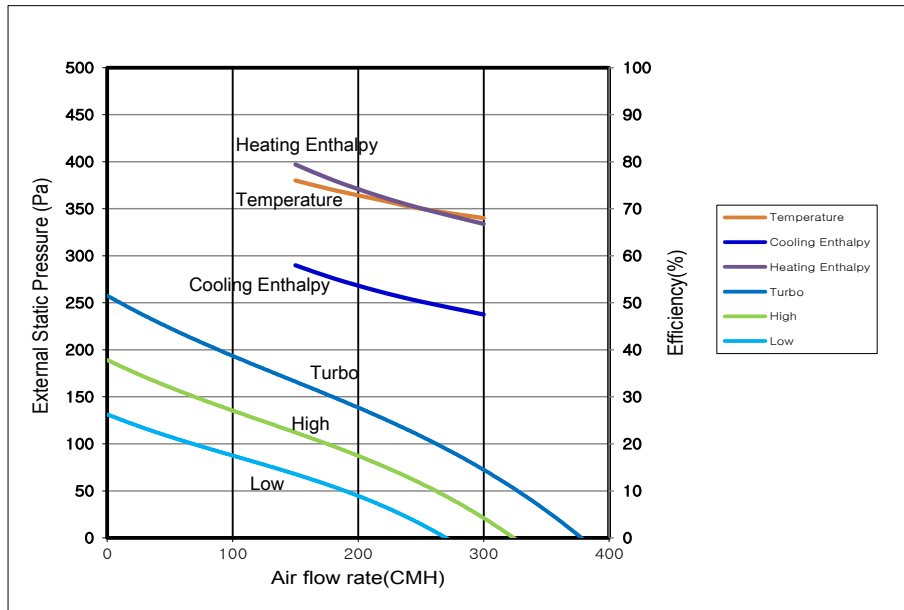

* Fan RPM step can be adjusted in Service mode with wired/wireless remote controller.
 Only Turbo step can be adjusted, and High and Low air flow rate follow the adjusted turbo step.
 * Each graph shows Air flow rate and ESP with recommended fan step.

3 Fan Characteristics

AN035JSKLKN

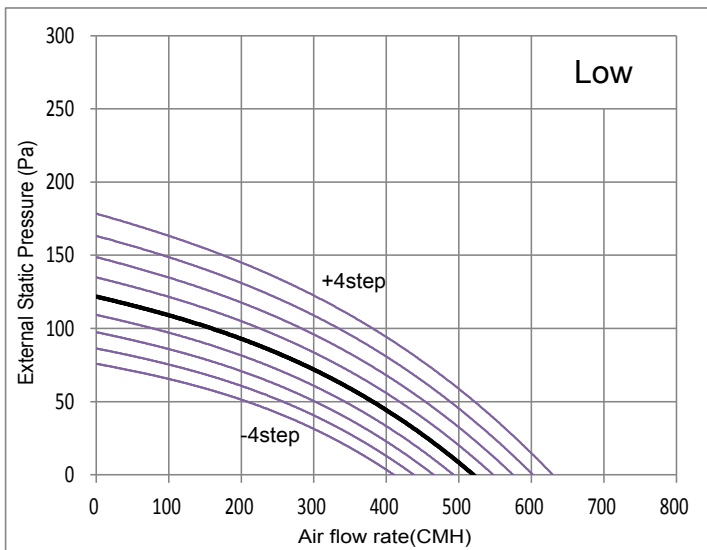
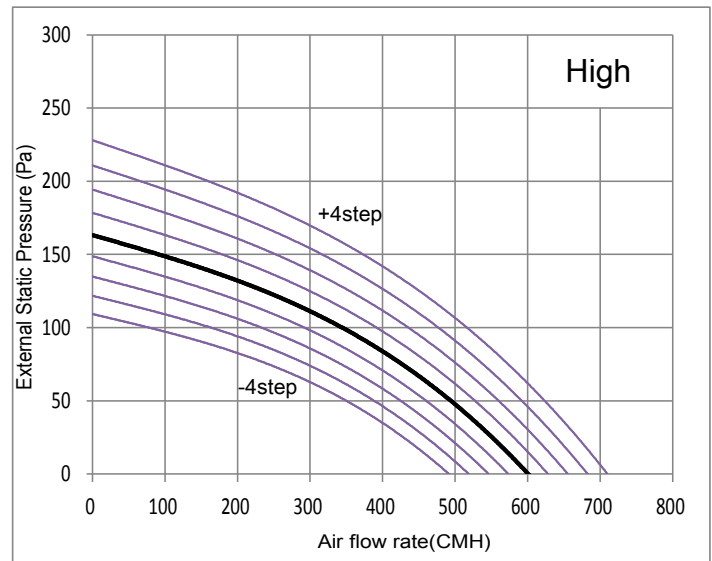
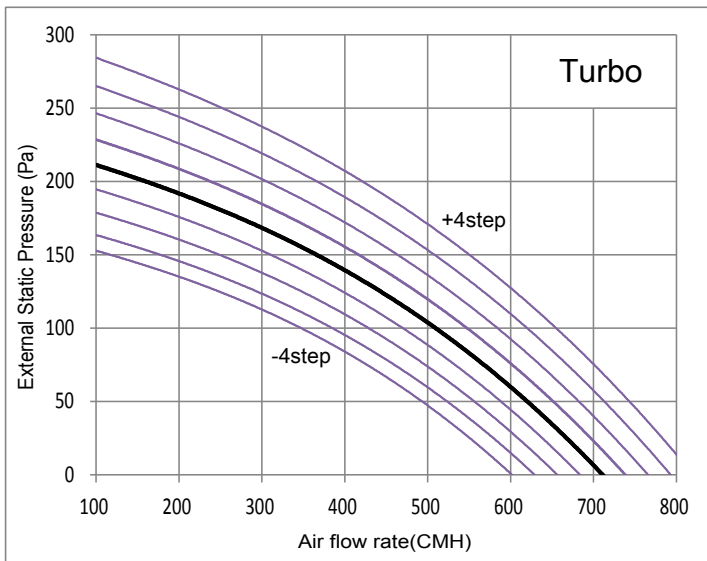
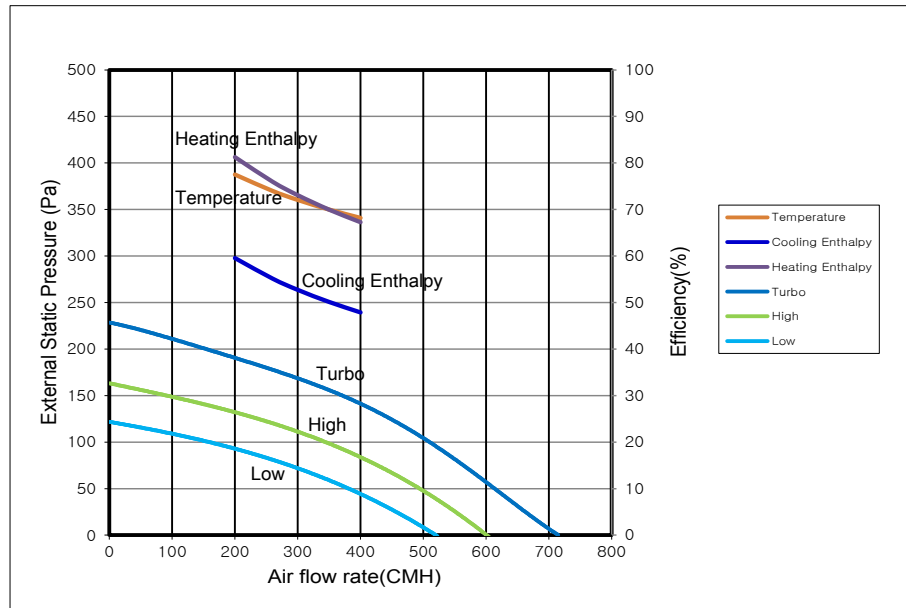

* Fan RPM step can be adjusted in Service mode with wired/wireless remote controller.
 Only Turbo step can be adjusted, and High and Low air flow rate follow the adjusted turbo step.
 * Each graph shows Air flow rate and ESP with recommended fan step.

3 Fan Characteristics

AN050JSKLKN

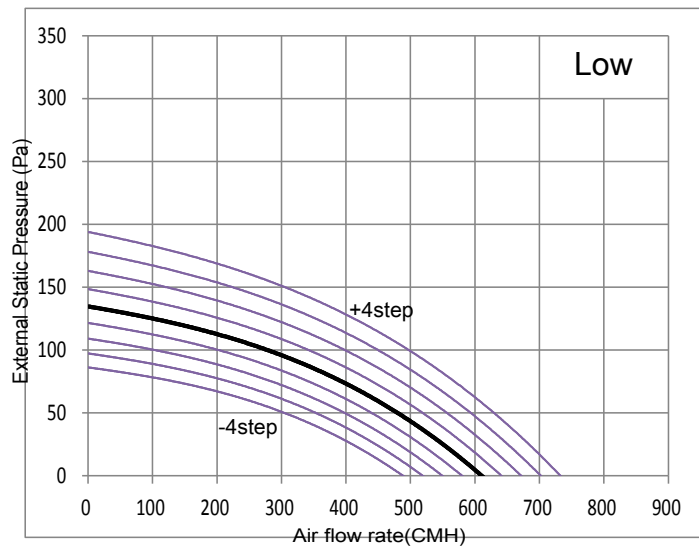
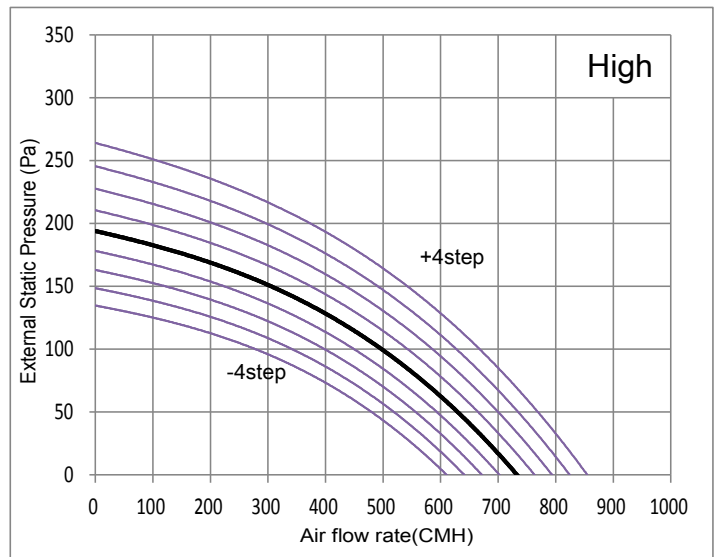
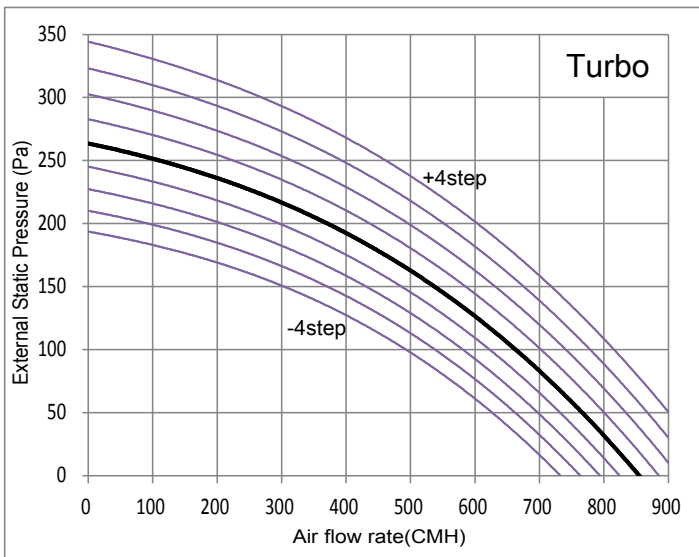
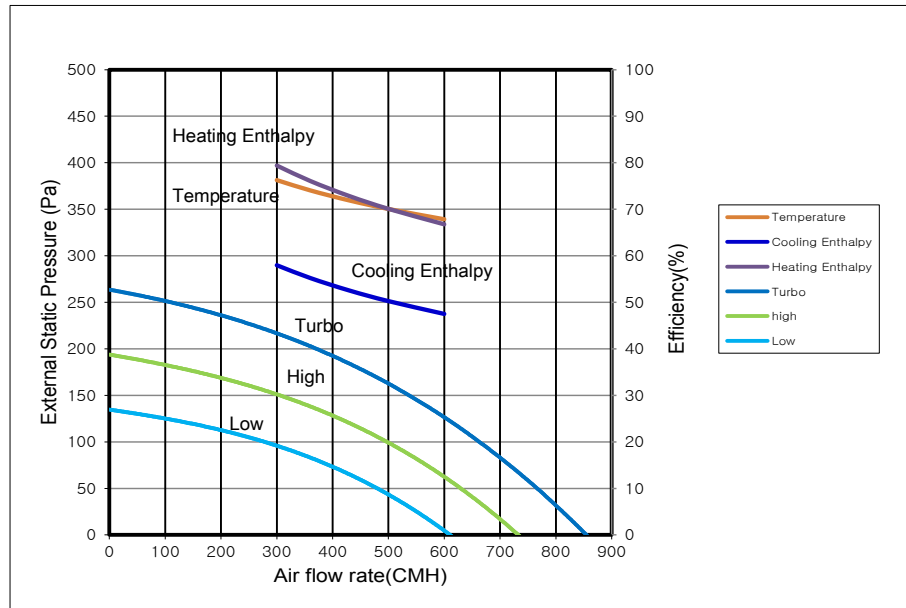

* Fan RPM step can be adjusted in Service mode with wired/wireless remote controller.
 Only Turbo step can be adjusted, and High and Low air flow rate follow the adjusted turbo step.
 * Each graph shows Air flow rate and ESP with recommended fan step.

3 Fan Characteristics

AN080JSKLKN

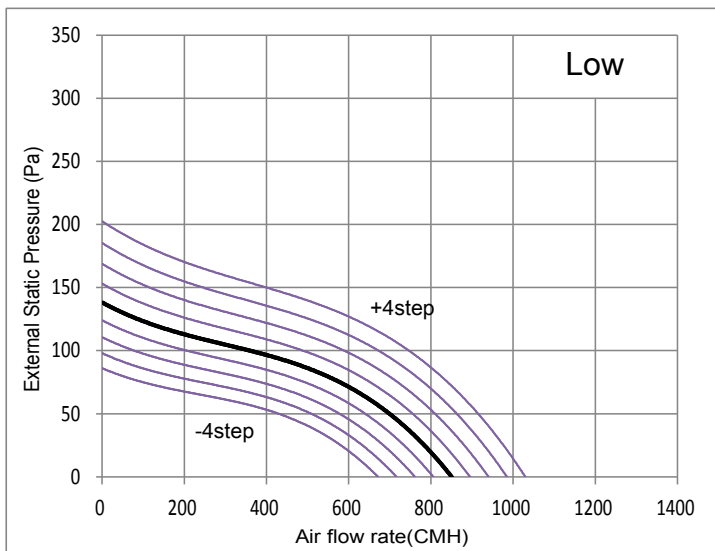
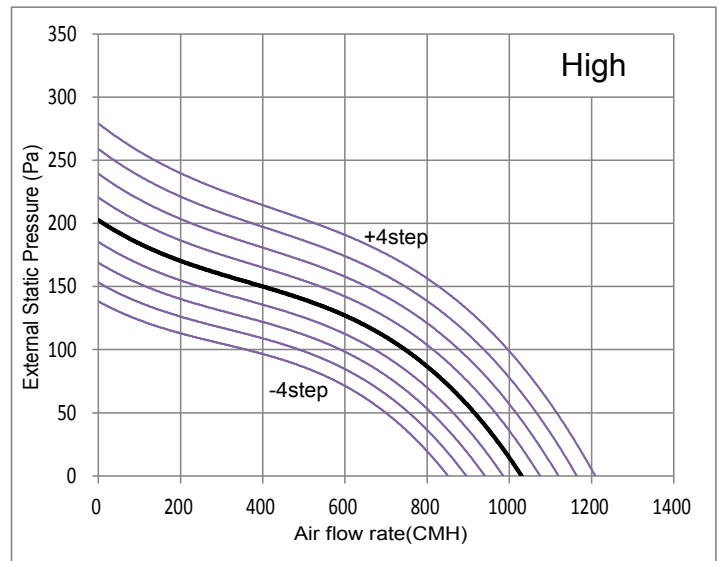
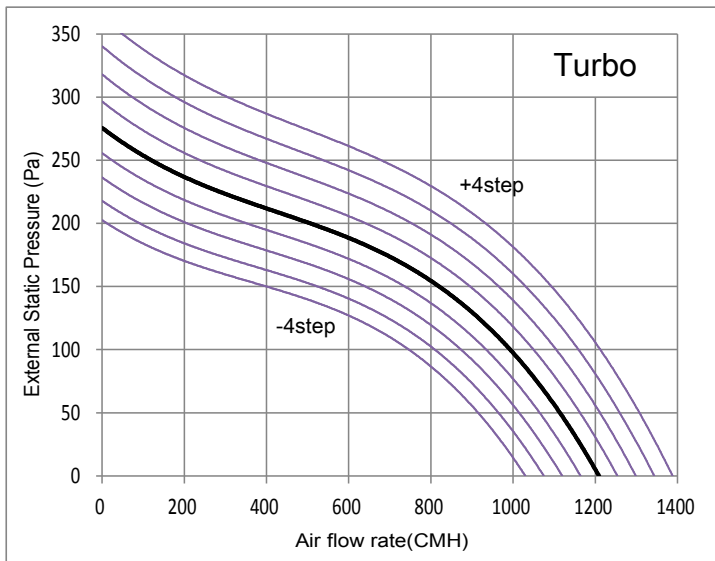
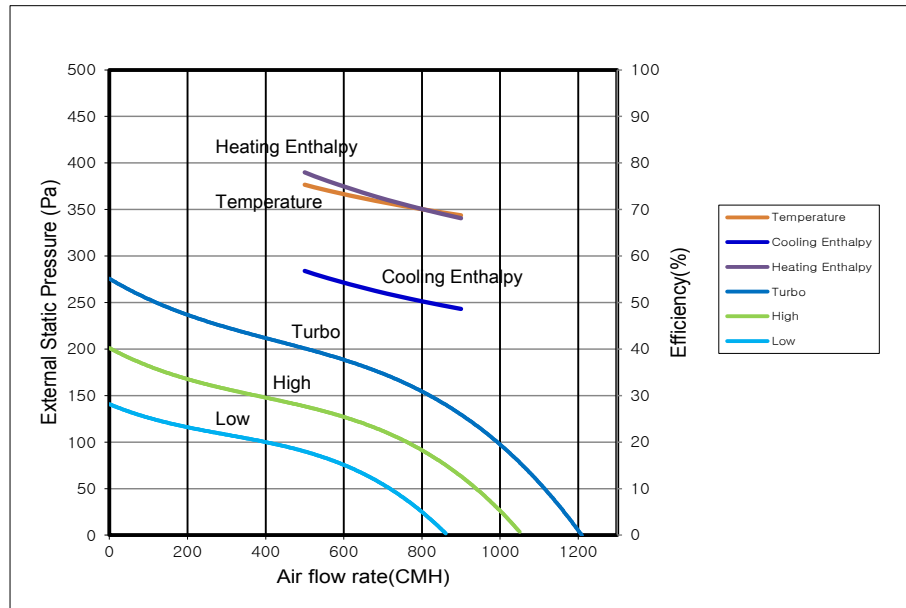

* Fan RPM step can be adjusted in Service mode with wired/wireless remote controller.
 Only Turbo step can be adjusted, and High and Low air flow rate follow the adjusted turbo step.
 * Each graph shows Air flow rate and ESP with recommended fan step.

3 Fan Characteristics

AN100JSKLKN

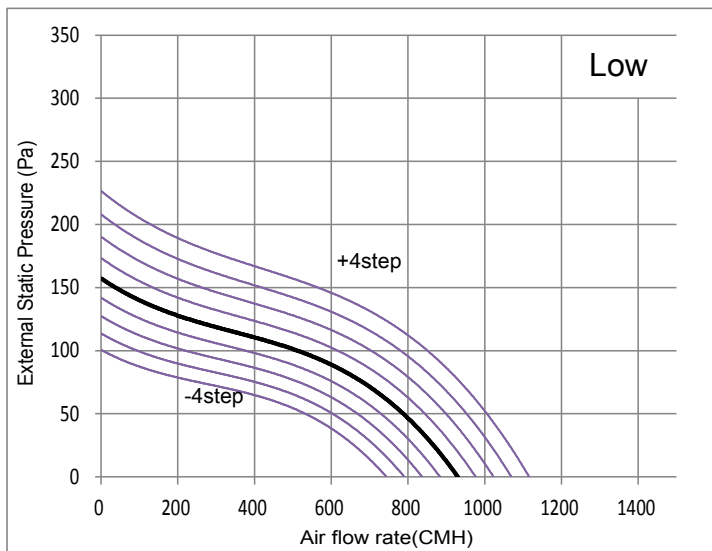
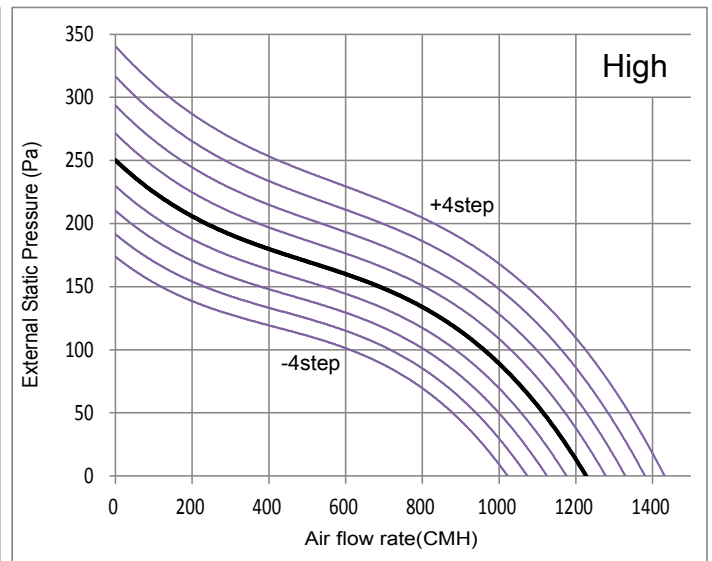
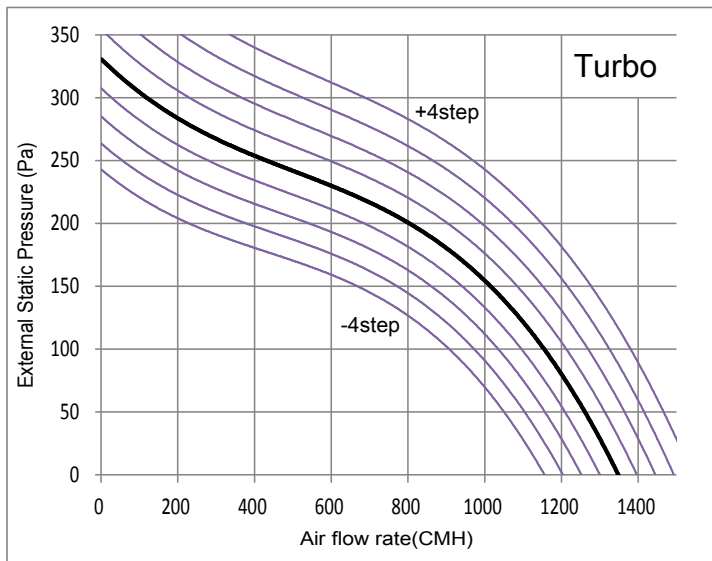
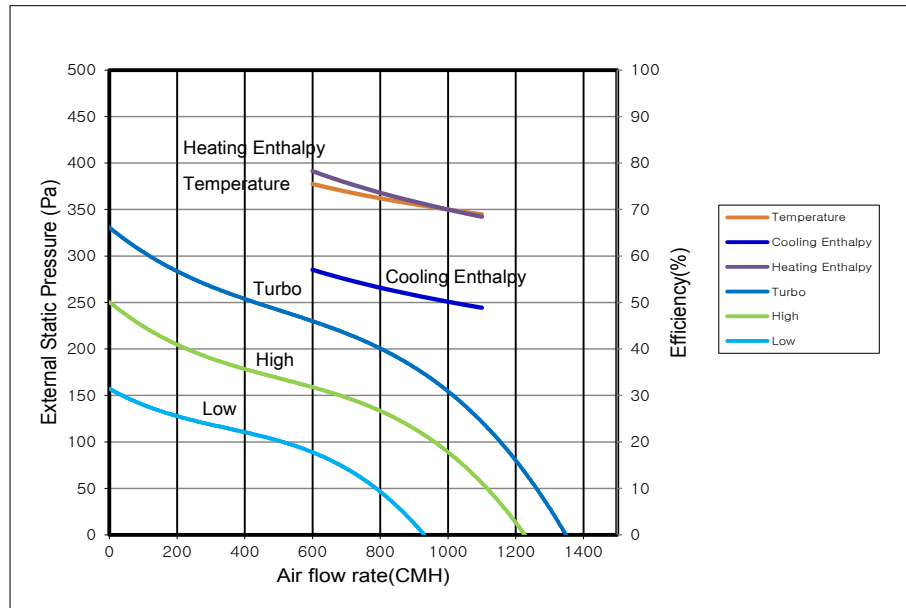

* Fan RPM step can be adjusted in Service mode with wired/wireless remote controller.
 Only Turbo step can be adjusted, and High and Low air flow rate follow the adjusted turbo step.
 * Each graph shows Air flow rate and ESP with recommended fan step.

4 Dimensional drawing

ERV

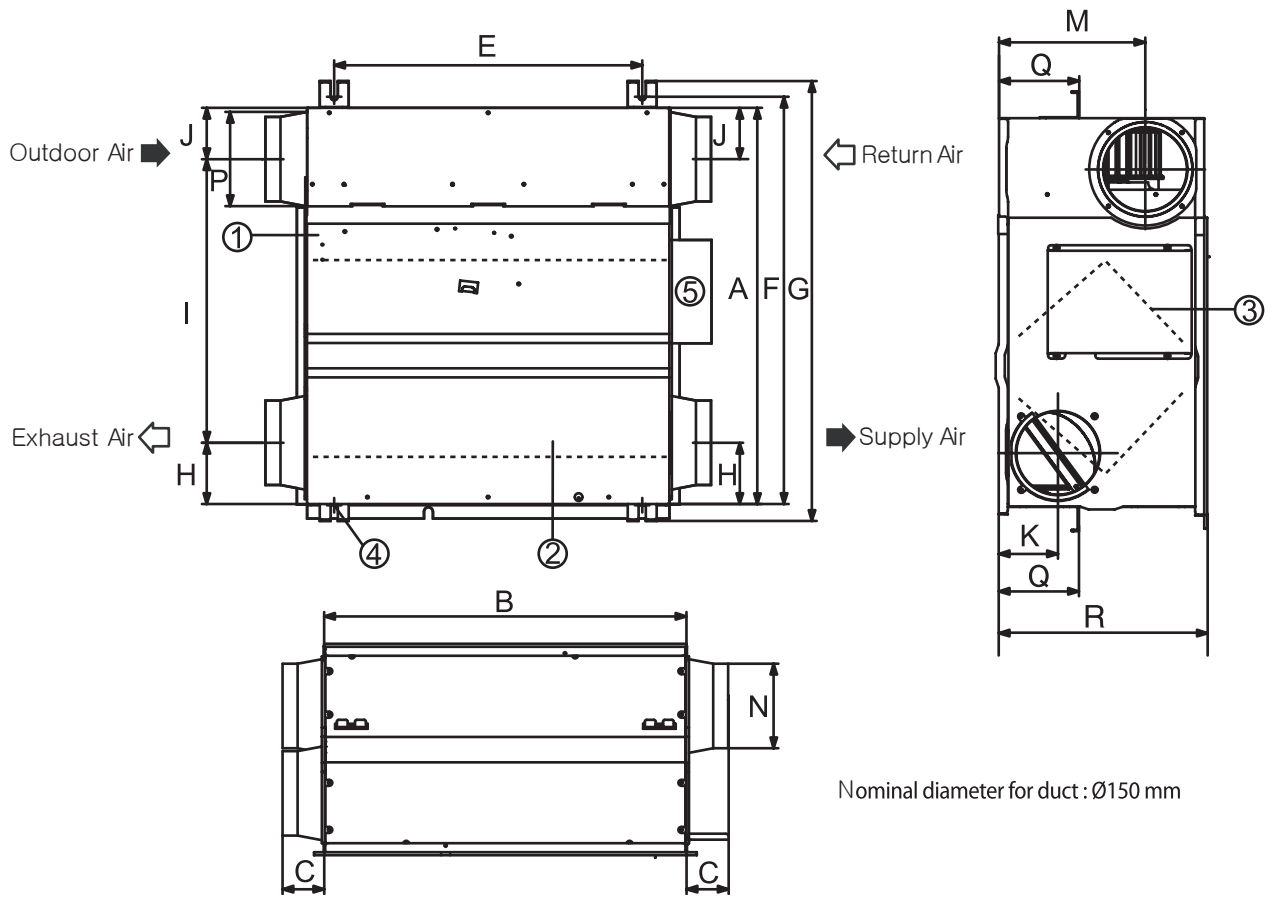

No.	Name	Quantity
①	Maintenance cover	1
②	Heat exchange element	1
③	Dust filter	2
④	Hanger	4
⑤	Electrical component box	1

Unit: mm

Model	A	B	C	E	F	G	H	I	J	K	M	N	P	Q	R
026	600	660	70	510	675	729	102	470	85	98	242	∅ 140	∅ 156	133	350

4 Dimensional drawing

ERV

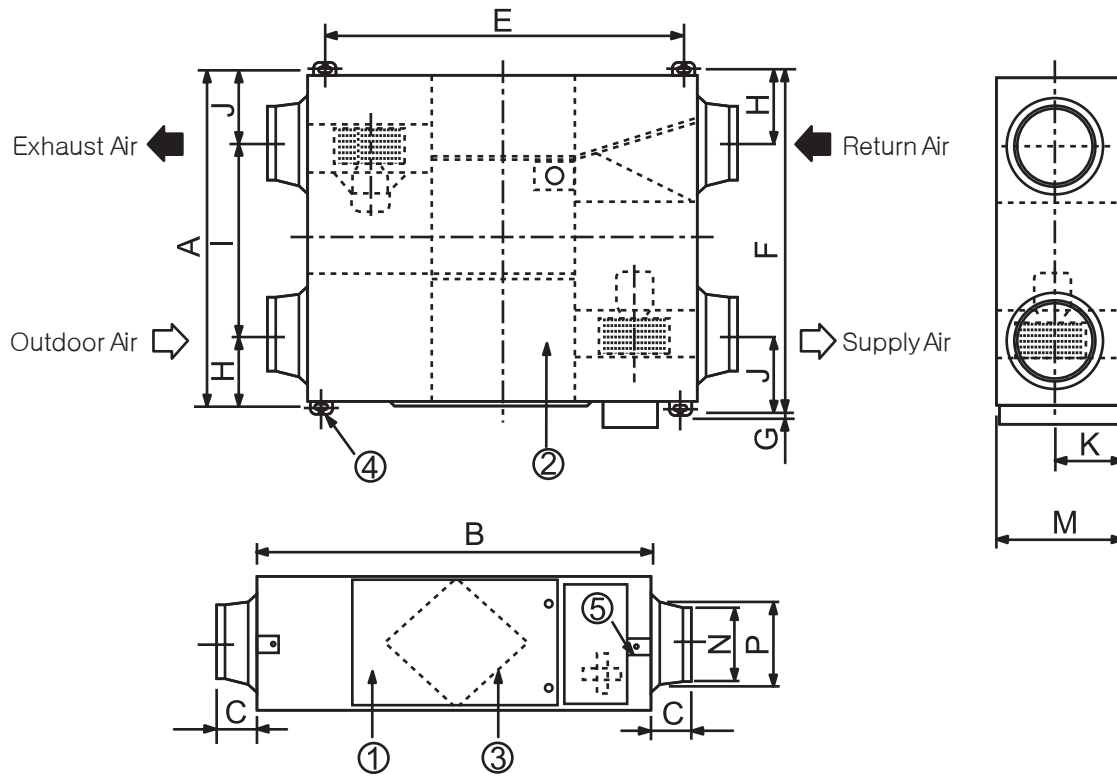

Model	Nominal diameter for duct
035/050	Ø200
080/100	Ø250

No.	Name	Quantity
①	Maintenance cover	1
②	Heat exchange element	2
③	Dust filter	4
④	Hanger	4
⑤	Electrical component box	1

Unit: mm

Model	A	B	C	E	F	G	H	I	J	K	M	N	P
035/050	1000	1012	99	9406	10364	26	130	617	253	135	270	Ø194	Ø241.5
080/100	1135	1220	84	1110	1183	25	184	61325	38775	170	340	Ø244	Ø270

5 Electrical wiring diagram

ERV

AN026JSKLN/EU, AN035JSKLN/EU, AN050JSKLN/EU, AN080JSKLN/EU, AN100JSKLN/EU

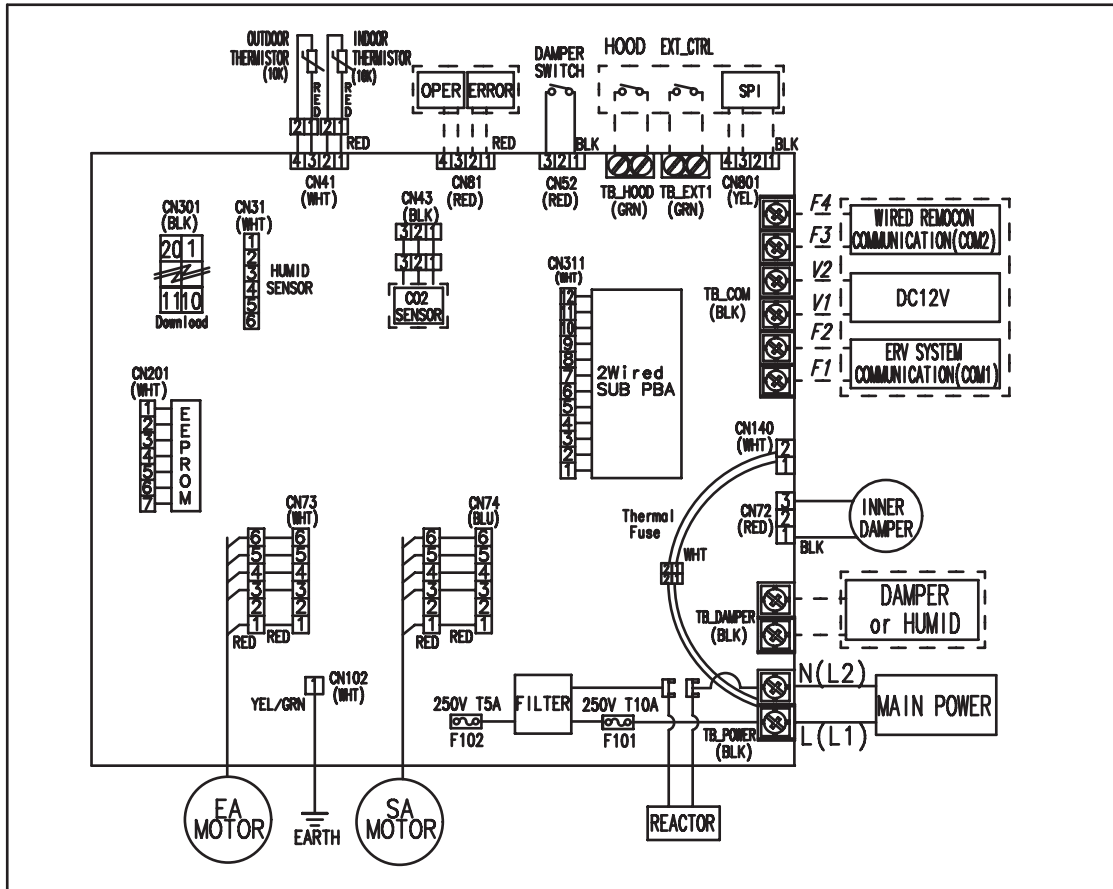

-- Thermistor : 25°C (77°F) at 10Kohm
 -- OPTION : [] [] []

* Display



SEG1 : "U" display when connected with wired remote controller
 SEG2 : Display RMC address (0 ~ F)
 SEG3/4 : Display Main Address(00 ~ 47)

* KEY Function

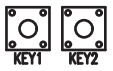

KEY1 : While operating the trial operation
 "F" is displayed on display
 KEY2 : VIEW Mode
 when press the KEY2 for 3secs,
 SET will reset in 40 secs

ERROR MODE		CODE
SENSOR ERROR	INDOOR TEMP. SENSOR ERROR (OPEN/SHORT)	121
	OUTDOOR TEMP. SENSOR ERROR (OPEN/SHORT)	221
	CO2 SENSOR ERROR (OPEN/SHORT)	139
	OUTDOOR HUMID SENSOR ERROR (OPEN/SHORT)	183
FAN ERROR	EXHAUST AIR FAN MOTOR ERROR	561
	SUPPLY AIR FAN MOTOR ERROR	562
COMM. ERROR	SYSTEM FAILURE BY COMM. ERROR AFTER TRACKING	202
	COMM. ERROR BETWEEN THE WIRED REMOTE CONTROLLER AND THE ERV	601
ETC	DUPLICATION OF MAIN ADDRESS WITH OTHER ERV UNIT	108
	EEPROM ERROR	162
	OPTION SETTING ERROR	163
	ERROR of Terminal Block's Thermal Fuse (OPEN) INDOOR or OUTDOOR TEMP IS UNDER 0°C(32°F) / STOP OPERATION	198 490

※ 602 ~ 609 indicated error due to the ERV wired remote control
 Refer to the ERV wired remote control installation error

CODE DB68-05350A

6 Sound pressure level

ERV

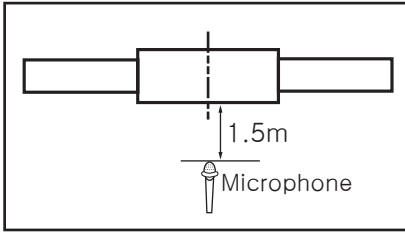

Unit: dB(A)

Model	Turbo	Quiet
AN026JSKLKN	31.0	22.0
AN035JSKLKN	32.0	23.0
AN050JSKLKN	35.0	24.0
AN080JSKLKN	36.0	25.0

Note

These operation values were obtained in an anechoic room. Sound pressure level will vary depending on a range of factors such as the
Operation sound level may differ depending on operation and ambient conditions.

NC curve

1) AN026JSKLKN

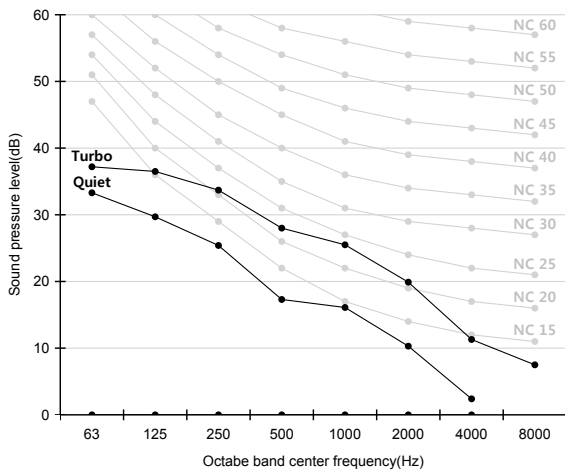

2) AN035JSKLKN

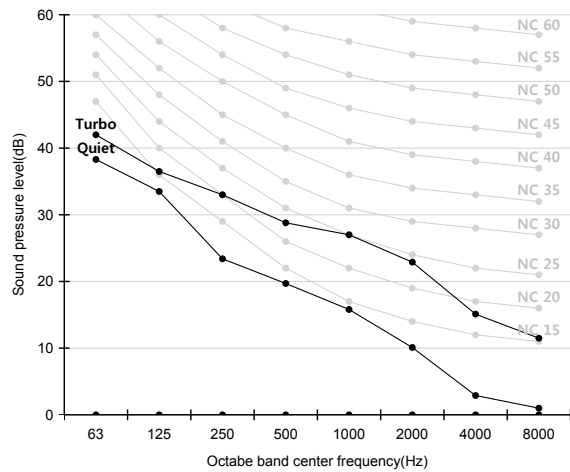

3) AN050JSKLKN

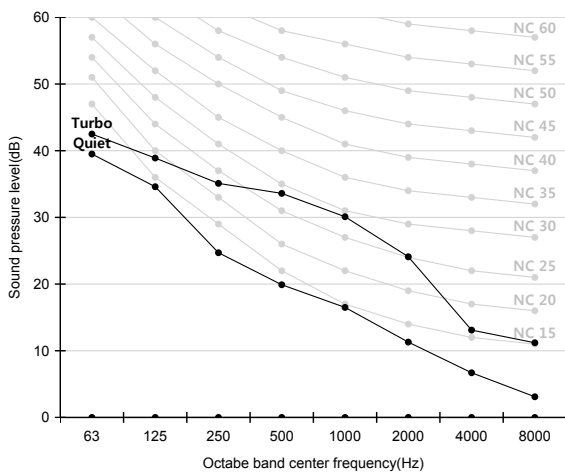

4) AN080JSKLKN

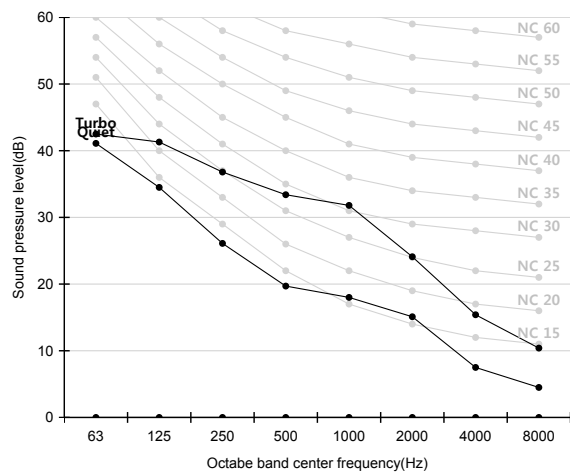

6 Sound pressure level

ERV

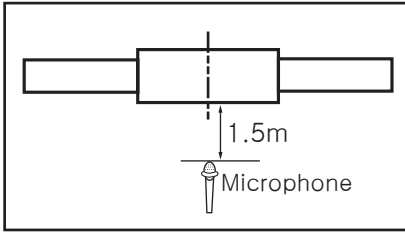

Unit: dB(A)

Model	Turbo	Quiet
AN100JSKLKN	37.0	26.0

Note

These operation values were obtained in an anechoic room. Sound pressure level will vary depending on a range of factors such as the
 Operation sound level may differ depending on operation and ambient conditions.

NC curve

1) AN100JSKLKN

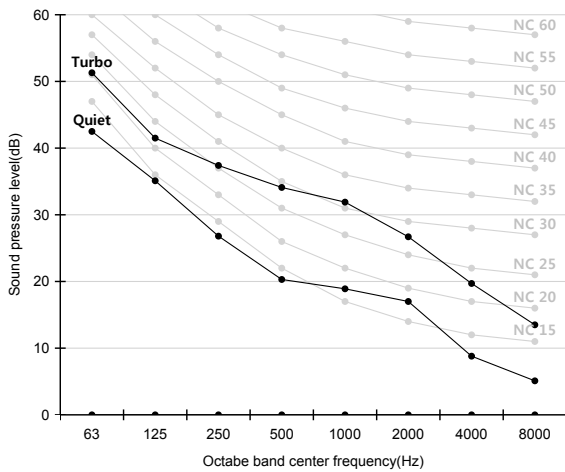

2015.06
Ver.1.1



Samsung Electronics Co., LTD.
B2B PM / SE

Head Office (Suwon Korea) 129, Samsung-Ro, Yeongtong-Gu, Suwon City, Gyeonggi-Do, Korea 443-742
Website : www.samsung.com Email : airconditioner@samsung.com
Images and data in this book may subject to change without prior notice.