



# SAMSUNG

## QUESTIONS OR COMMENTS?

COUNTRY	CALL	OR VISIT US ONLINE AT
UK	0330 SAMSUNG (7267864)	<a href="http://www.samsung.com/uk/support">www.samsung.com/uk/support</a>
EIRE	0818 717100	<a href="http://www.samsung.com/ie/support">www.samsung.com/ie/support</a>
GERMANY	0180 6 SAMSUNG bzw. 0180 6 7267864* (*0,20 €/Anruf aus dem dt. Festnetz, aus dem Mobilfunk max. 0,60 €/Anruf) [HHP] 0180 6 M SAMSUNG bzw. 0180 6 67267864* (*0,20 €/Anruf aus dem dt. Festnetz, aus dem Mobilfunk max. 0,60 €/Anruf)	<a href="http://www.samsung.com/de/support">www.samsung.com/de/support</a>
FRANCE	01 48 63 00 00	<a href="http://www.samsung.com/fr/support">www.samsung.com/fr/support</a>
ITALIA	800-SAMSUNG (800.7267864)	<a href="http://www.samsung.com/it/support">www.samsung.com/it/support</a>
SPAIN	0034902172678 [HHP] 0034902167267	<a href="http://www.samsung.com/es/support">www.samsung.com/es/support</a>
PORTUGAL	808 20 7267	<a href="http://www.samsung.com/pt/support">www.samsung.com/pt/support</a>
LUXEMBURG	261 03 710	<a href="http://www.samsung.com/be_fr/support">www.samsung.com/be_fr/support</a>
NETHERLANDS	0900-SAMSUNG (0900-7267864) (€ 0,10/Min)	<a href="http://www.samsung.com/nl/support">www.samsung.com/nl/support</a>
BELGIUM	02-201-24-18	<a href="http://www.samsung.com/be/support">www.samsung.com/be/support</a> (Dutch) <a href="http://www.samsung.com/be_fr/support">www.samsung.com/be_fr/support</a> (French)
NORWAY	815 56480	<a href="http://www.samsung.com/no/support">www.samsung.com/no/support</a>
DENMARK	70 70 19 70	<a href="http://www.samsung.com/dk/support">www.samsung.com/dk/support</a>
FINLAND	030-6227 515	<a href="http://www.samsung.com/fi/support">www.samsung.com/fi/support</a>
SWEDEN	0771 726 7864 (0771-SAMSUNG)	<a href="http://www.samsung.com/se/support">www.samsung.com/se/support</a>
POLAND	801-172-678* lub +48 22 607-93-33* Dedykowana infolinia do obsługi zapytań dotyczących telefonów komórkowych: 801-672-678* lub +48 22 607- 93-33* * (koszt połączenia według taryfy operatora)	<a href="http://www.samsung.com/pl/support">www.samsung.com/pl/support</a>
HUNGARY	0680SAMSUNG (0680-726-786) 0680PREMIUM (0680-773-648)	<a href="http://www.samsung.com/hu/support">www.samsung.com/hu/support</a>
AUSTRIA	0800-SAMSUNG (0800-7267864) [Only for Premium HA] 0800-366661 [Only for Dealers] 0810-112233	<a href="http://www.samsung.com/at/support">www.samsung.com/at/support</a>
SWITZERLAND	0800 726 78 64 (0800-SAMSUNG)	<a href="http://www.samsung.com/ch/support">www.samsung.com/ch/support</a> (German) <a href="http://www.samsung.com/ch_fr/support">www.samsung.com/ch_fr/support</a> (French)
CZECH	800 - SAMSUNG (800-726786)	<a href="http://www.samsung.com/cz/support">www.samsung.com/cz/support</a>
SLOVAKIA	0800 - SAMSUNG (0800-726 786)	<a href="http://www.samsung.com/sk/support">www.samsung.com/sk/support</a>
CROATIA	072 726 786	<a href="http://www.samsung.com/hr/support">www.samsung.com/hr/support</a>
BOSNIA	055 233 999	<a href="http://www.samsung.com/support">www.samsung.com/support</a>
MONTENEGRO	020 405 888	<a href="http://www.samsung.com/support">www.samsung.com/support</a>
SLOVENIA	080 697 267 (brezplačna številka)	<a href="http://www.samsung.com/si">www.samsung.com/si</a>
SERBIA	011 321 6899	<a href="http://www.samsung.com/rs/support">www.samsung.com/rs/support</a>
BULGARIA	*3000 Цена в мрежата 0800 111 31 . Безплатна телефонна линия	<a href="http://www.samsung.com/bg/support">www.samsung.com/bg/support</a>
ROMANIA	*8000 (apel in retea) 08008-726-78-64 (08008-SAMSUNG) Apel GRATUIT	<a href="http://www.samsung.com/ro/support">www.samsung.com/ro/support</a>
CYPRUS	8009 4000 only from landline, toll free	
GREECE	80111-SAMSUNG (80111 726 7864) only from land line (+30) 210 6897691 from mobile and land line	<a href="http://www.samsung.com/gr/support">www.samsung.com/gr/support</a>
LITHUANIA	8-800-7777	<a href="http://www.samsung.com/lt/support">www.samsung.com/lt/support</a>
LATVIA	8000-7267	<a href="http://www.samsung.com/lv/support">www.samsung.com/lv/support</a>
ESTONIA	800-7267	<a href="http://www.samsung.com/ee/support">www.samsung.com/ee/support</a>



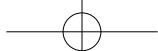

# Air conditioner

---

## User manual

AR\*\*HS/JS\*\*

---

- Thank you for purchasing this Samsung air conditioner.
- Before operating this unit, please read this user manual carefully and retain it for future reference.



**SAMSUNG**

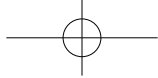

# Contents

---

<b>Safety Information</b>	<b>4</b>
Safety Information	4
<b>At a Glance</b>	<b>12</b>
Indoor Unit Overview	12
Display	
Remote Control Overview	13
Inserting batteries	
Remote Control Operation	14
Operation modes	
Controlling temperature	
Controlling fan speed	
Controlling air flow direction	
Setting the Current time	
<b>Power Smart Features</b>	<b>16</b>
Cooling Operation	16
Cool mode	
2-Step cooling function	
Dehumidifying Operation	17
Dry mode	
Air Purifying Operation	18
Virus doctor function	
Heating Operation	19
Heat mode	
Quick Smart Features	20
Auto mode	
Fan mode	
Fast function	
Comfort function	
Beep sound function	
Quiet function	
Display lighting function	
Wi-Fi function (Smart A/C application)	
<b>Energy-Saving Features</b>	<b>24</b>
Energy-Saving Operation	24
Electricity consumption check	



Single user function  
 Timed on/Timed off function  
 good'sleep function

---

**Cleaning and Maintenance** **28**

Cleaning at a Glance	28
Troubleshooting	30



**Correct Disposal of This Product  
 (Waste Electrical & Electronic Equipment)**

**(Applicable in countries with separate collection systems)**

This marking on the product, accessories or literature indicates that the product and its electronic accessories (e.g. charger, headset, USB cable) should not be disposed of with other household waste at the end of their working life. To prevent possible harm to the environment or human health from uncontrolled waste disposal, please separate these items from other types of waste and recycle them responsibly to promote the sustainable reuse of material resources.

Household users should contact either the retailer where they purchased this product, or their local government office, for details of where and how they can take these items for environmentally safe recycling.

Business users should contact their supplier and check the terms and conditions of the purchase contract. This product and its electronic accessories should not be mixed with other commercial wastes for disposal.



**Correct disposal of batteries in this product**

**(Applicable in countries with separate collection systems)**

This marking on the battery, manual or packaging indicates that the batteries in this product should not be disposed of with other household waste at the end of their working life. Where marked, the chemical symbols Hg, Cd or Pb indicate that the battery contains mercury, cadmium or lead above the reference levels in EC Directive 2006/66. If batteries are not properly disposed of, these substances can cause harm to human health or the environment.

To protect natural resources and to promote material reuse, please separate batteries from other types of waste and recycle them through your local, free battery return system.

For information on Samsung's environmental commitments and product specific regulatory obligations e.g. REACH visit: [samsung.com/uk/aboutsamsung/samsungelectronics/corporatecitizenship/data\\_corner.html](https://samsung.com/uk/aboutsamsung/samsungelectronics/corporatecitizenship/data_corner.html)

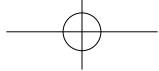

## Safety Information

---





Before using your new air conditioner, please read this manual thoroughly to ensure that you know how to safely and efficiently operate the extensive features and functions of your new appliance. Because the following operating instructions cover various models, the characteristics of your air conditioner may differ slightly from those described in this manual. If you have any questions, call your nearest contact centre or find help and information online at [www.samsung.com](http://www.samsung.com).

### **WARNING**

Hazards or unsafe practices that may result in severe personal injury or death.

### **CAUTION**

Hazards or unsafe practices that may result in minor personal injury or property damage.

-  Follow directions.
-  Do NOT attempt.
-  Make sure the machine is grounded to prevent electric shock.
-  Cut off the power supply.
-  Do NOT disassemble.

## FOR INSTALLATION

---

### **WARNING**

-  **Use a power cord with this product's power specifications or higher and use the power cord for this appliance only. In addition, do not use an extension cord.**
  - Extending the power cord may result in electric shock or fire.
  - Do not use an electric transformer. This may result in electric shock or fire.

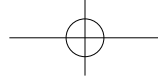

- If the voltage/frequency/rated current condition is different, it may cause fire.

**The installation of this appliance must be performed by a qualified technician or service company.**

- Failing to do so may result in electric shock, fire, explosion, problems with the product, or injury and may also void warranty on the installed product.

**Install an Isolation Switch next to the Air Conditioner (but not on the panels of the Air Conditioner) and circuit breaker dedicated to the air conditioner.**

- Failing to do so may result in electric shock or fire.

**Fix the outdoor unit firmly so that the electric part of the outdoor unit is not exposed.**

- Failing to do so may result in electric shock, fire, explosion, or problems with the product.

- ⊘ **Do not install this appliance near a heater, or inflammable material. Do not install this appliance in a humid, oily or dusty location, in a location exposed to direct sunlight and water (or rain). Do not install this appliance in a location where gas may leak.**

- This may result in electric shock or fire.

**Never install the outdoor unit in a location such as on a high external wall where it could fall.**

- If the outdoor unit falls, it may result in injury, death or property damage.

- ⚡ **This appliance must be properly grounded. Do not ground the appliance to a gas pipe, plastic water pipe, or telephone line.**

- Failing to do so may result in electric shock, fire, and explosion.
- Make sure to use a socket-outlet with ground.

 **CAUTION**

- 
- Please cover the air conditioner with PE BAG after installation, and remove it when you start to run air conditioner.**

**Install your appliance on a level and hard floor that can support its weight.**

- Failing to do so may result in abnormal vibrations, noise, or problems with the product.

**Install the drain hose properly so that water drains correctly.**



- Failing to do so may result in water overflowing and property damage. Avoid adding drain to waste pipes as odours may arise in the future.

**When installing the outdoor unit, make sure to connect the drain hose so that draining is performed correctly.**

- The water generated during heating by the outdoor unit may overflow and result in property damage. In particular, in winter, if a block of ice falls, it may result in injury, death or property damage.

## FOR POWER SUPPLY

 **WARNING**

- 
- When the circuit breaker is damaged, contact your nearest service centre.**
- 
- 
- Do not pull or excessively bend the power line. Do not twist or tie the power line. Do not hook the power line over a metal object, place a heavy object on the power line, insert the power line between objects, or push the power line into the space behind the appliance.**
- This may result in electric shock or fire.

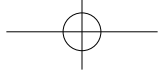

---

 **CAUTION**

 **When not using the air conditioner for a long period of time or during a thunder/lightning storm, cut the power at the circuit breaker.**

- Failing to do so may result in electric shock or fire.

---

**FOR USING**

 **WARNING**

 **If the appliance is flooded, please contact your nearest service centre.**

- Failing to do so may result in electric shock or fire.

**If the appliance generates a strange noise, a burning smell or smoke, cut off the power supply immediately and contact the nearest service centre.**

- Failing to do so may result in electric shock or fire.

**In the event of a gas leak (such as propane gas, LP gas, etc.), ventilate immediately without touching the power line. Do not touch the appliance or power line.**

- Do not use a ventilating fan.
- A spark may result in an explosion or fire.

**To reinstall the air conditioner, please contact your nearest service centre.**

- Failing to do so may result in problems with the product, water leakage, electric shock, or fire.
- Delivery service for the product is not provided. If you reinstall the product in another location, additional construction expenses and an installation fee will be charged.



- Especially, when you wish to install the product in an unusual location such as in an industrial area or near the seaside where it is exposed to salt in the air, please contact your nearest service centre.

**⊘ Do not touch the circuit breaker with wet hands.**

- This may result in electric shock.

**Do not turn the air conditioner off with the circuit breaker while it is operating.**

- Turning the air conditioner off and then on again with the circuit breaker may cause a spark and result in electric shock or fire.

**After unpacking the air conditioner, keep all packaging materials well out of the reach of children, as packaging materials can be dangerous to children.**

- If a child places a bag over its head, it may result in suffocation.

**Do not touch the air flow blade with your hands or fingers during heating.**

- This may result in electric shock or burns.

**Do not insert your fingers or foreign substances into the air inlet/outlet of the air conditioner.**

- Take special care that children do not injure themselves by inserting their fingers into the product.

**Do not strike or pull the air conditioner with excessive force.**

- This may result in fire, injury, or problems with the product.

**Do not place an object near the outdoor unit that allows children to climb onto the machine.**

- This may result in children seriously injuring themselves.

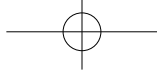

**Do not use this air conditioner for long periods of time in badly ventilated locations or near infirm people.**

- Since this may be dangerous due to a lack of oxygen, open a window at least once an hour.



**If any foreign substance such as water has entered the appliance, cut off the power supply and contact the nearest service centre.**

- Failing to do so may result in electric shock or fire.



**Do not attempt to repair, disassemble, or modify the appliance yourself.**

- Do not use any fuse (such as cooper, steel wire, etc.) other than the standard fuse.
- Failing to do so may result in electric shock, fire, problems with the product, or injury.



### **CAUTION**



**Do not place objects or devices under the indoor unit.**

- Water dripping from the indoor unit may result in fire or property damage.

**Check that the installation frame of the outdoor unit is not broken at least once a year.**

- Failing to do so may result in injury, death or property damage.

**Max current is measured according to IEC standard for safety and current is measured according to ISO standard for energy efficiency.**



**Do not stand on top of the appliance or place objects (such as laundry, lighted candles, lighted cigarettes, dishes, chemicals, metal objects, etc.) on the appliance.**

- This may result in electric shock, fire, problems with the product, or injury.

**Do not operate the appliance with wet hands.**

- This may result in electric shock.

**Do not spray volatile material such as insecticide onto the surface of the appliance.**

- As well as being harmful to humans, it may also result in electric shock, fire or problems with the product.

**Do not drink the water from the air conditioner.**

- The water may be harmful to humans.

**Do not apply a strong impact to the remote control and do not disassemble the remote control.**

**Do not touch the pipes connected with the product.**

- This may result in burns or injury.

**Do not use this air conditioner to preserve precision equipment, food, animals, plants or cosmetics, or for any other unusual purposes.**

- This may result in property damage.

**Avoid directly exposing humans, animals or plants to the air flow from the air conditioner for long periods of time.**

- This may result in harm to humans, animals or plants.

**This appliance is not intended for use by persons (including children) with reduced physical, sensory or mental capabilities, or lack of experience and knowledge, without supervision or instruction concerning use of the appliance by a person responsible for their safety. Children should be supervised to ensure that they do not play with the appliance.**

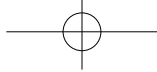

**For use in Europe :** This appliance can be used by children aged from 8 years and above and persons with reduced physical, sensory or mental capabilities or lack of experience and knowledge if they have been given supervision or instruction concerning use of the appliance in a safe way and understand the hazards involved. Children shall not play with the appliance. Cleaning and user maintenance shall not be made by children without supervision.

## FOR CLEANING



### WARNING



**Do not clean the appliance by spraying water directly onto it. Do not use benzene, thinner or alcohol to clean the appliance.**

- This may result in discolouration, deformation, damage, electric shock or fire.

**Before cleaning or performing maintenance, cut off the power supply and wait until the fan stops.**

- Failing to do so may result in electric shock or fire.



### CAUTION



**Take care when cleaning the surface of the heat exchanger of the outdoor unit since it has sharp edges.**

- This should be done by a qualified technician. Please contact your installer or service centre.



**Do not clean the inside of the air conditioner by yourself.**

- For cleaning inside the appliance, contact your nearest service centre.
- When cleaning the filter, refer to the descriptions in the 'Cleaning at a Glance' section.
- Failing to do so may result in damage, electric shock or fire.



# Indoor Unit Overview

The actual product may differ slightly from the image depicted below.

At a Glance

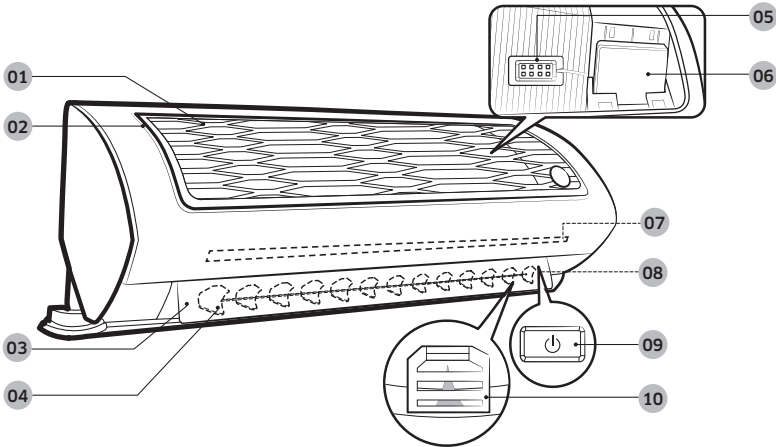

- 01 Air intake
- 02 Air filter
- 03 Air flow blade (up and down)
- 04 Air flow blade (left and right)
- 05 Room temperature sensor
- 06 Wi-Fi module
- 07 Virus doctor lamp
- 08 Display
- 09 Power button / Remote control receiver
- 10 (Inside) Virus doctor

## Display

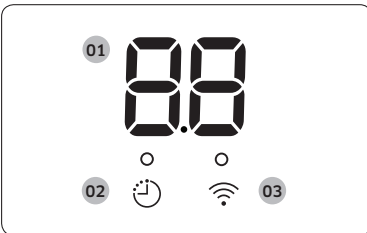

- 01 Temperature indicator  
Filter reset indicator (CF)  
Electricity consumption indicator  
Auto clean indicator (C!)  
Defrost indicator (dF)
- 02 Timer indicator  
good'sleep indicator  
Auto clean indicator
- 03 Wi-Fi indicator

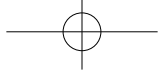

# Remote Control Overview

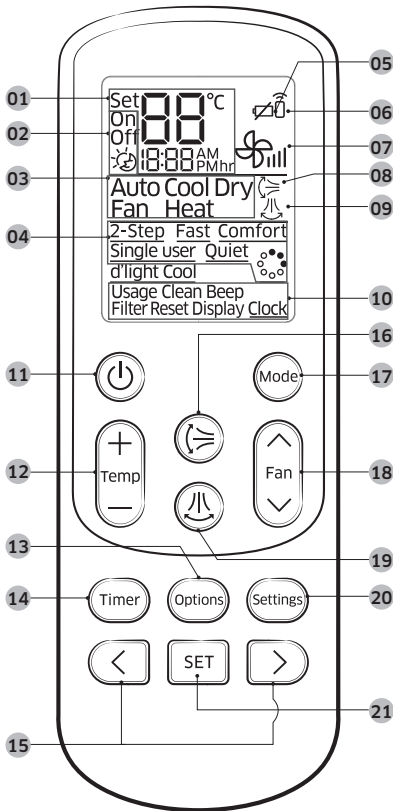

- 01 Set temperature indicator
- 02 Timer option indicator
- 03 Operation mode indicator
- 04 Options indicator
- 05 Low battery indicator
- 06 Transmit indicator
- 07 Fan speed indicator
- 08 Vertical air swing indicator
- 09 Horizontal air swing indicator
- 10 Settings indicator
- 11 Power button
- 12 Temperature button
- 13 Options button
- 14 Timer button
- 15 Direction button / Selection button
- 16 Vertical air swing button
- 17 Mode button
- 18 Fan speed button
- 19 Horizontal air swing button
- 20 Settings button
- 21 SET button

At a Glance

## Inserting batteries

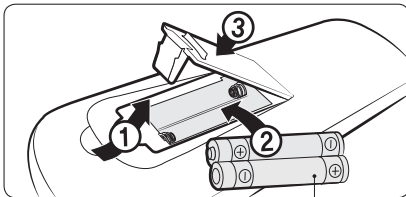

two 1.5V AAA type batteries

### NOTE

- The descriptions in this manual are primarily made based on the remote control buttons.
- Although **d'light Cool** is displayed on the remote control display, it is not available on this model.

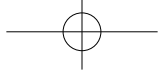

# Remote Control Operation

You can use the air conditioner easily by selecting a mode and then by controlling the temperature, fan speed, and air direction.

At a Glance



## Operation modes

You can change the current mode between Auto, Cool, Dry, Fan, and Heat by pressing the  button.

## Controlling temperature

You can control the temperature in each mode as follows:

Mode	Temperature control
Auto/Cool/Heat	Adjust by 1 °C between 16 °C and 30 °C.
Dry	Adjust by 1 °C between 18 °C and 30 °C.
Fan	You cannot control the temperature.

### NOTE

You can use the Cool, Dry, and Heat modes in the following conditions:

Mode	Cool	Dry	Heat
Indoor temperature	16 °C to 32 °C	18 °C to 32 °C	27 °C or less
Outdoor temperature	-10 °C to 46 °C	-10 °C to 46 °C	-15 °C to 24 °C
Indoor humidity	80% or less relative humidity	-	-

- If the air conditioner operates in a high humidity environment in the Cool mode for an extended period of time, condensation may occur.
- If the outdoor temperature drops to -5°C, the heating capacity may decrease to as much as 60% to 70% of the specified capacity.



### Model : AJ\*\*\*

Mode	Cool	Dry	Heat
Indoor temperature	16 °C to 32 °C	18 °C to 32 °C	27 °C or less
Outdoor temperature	-5 °C to 46 °C	-5 °C to 46 °C	-15 °C to 24 °C
Indoor humidity	80% or less relative humidity	-	-
Remark	AJ100*** outdoor temperature : -10°C to 46°C .	AJ100*** outdoor temperature : -10°C to 46°C.	

- The standardized temperature for heating is 7°C. If the outdoor temperature drops to 0°C or below, the heating capacity can be reduced depending on the temperature condition.
- If the cooling operation is used at over 32°C (indoor temperature), it does not cool at its full capacity.



### Controlling fan speed

You can select the following fan speeds in each mode:

Mode	Available fan speeds
Auto/Dry	☼ (Auto)
Cool/Heat	☼ (Auto), ☼ (Low), ☼ (Med), ☼ (High), ☼ (Turbo)
Fan	☼ (Low), ☼ (Med), ☼ (High), ☼ (Turbo)

### Controlling air flow direction

Keep the air flow in a constant direction by stopping the movements of the vertical and horizontal air flow blades.

In operation ► or

#### NOTE

- If you adjust the vertical air flow blade manually, it may not close completely when you turn off the air conditioner.
- If you adjust the horizontal air flow blade manually, it may not operate normally.
- You can control the air flow direction when the good'sleep function is running while in the Heat mode, but not while in the Cool mode.



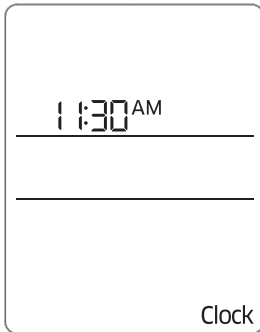

## Setting the Current time

Before using the functions of the air-conditioner, set the current time.

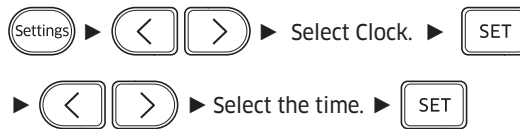

### NOTE

- You can set the time in hourly units from 1 hour ~ 12 hours according to AM, PM and in minute units from 0 ~ 59 minutes.
- Current time setting will be cancelled if you don't press the SET button within 10 seconds after setting the time. Therefore, check for the current time on the remote controller display.

## Cooling Operation

The smart and powerful cooling functions of the Samsung air conditioner keep an enclosed space cool and comfortable.

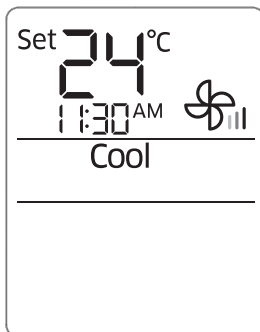

## Cool mode

Use the Cool mode to stay cool in hot weather.



### NOTE

- For comfort, keep the temperature difference between the indoor and outdoor air within 5 °C in the Cool mode.
- After selecting the Cool mode, select a function, temperature, and fan speed that you want to apply.
  - To cool your room quickly, select a low temperature and a strong fan speed.
  - To save energy, select a high temperature and a weak fan speed.
  - As the indoor temperature approaches the set temperature, the compressor will operate at a low speed to save energy.

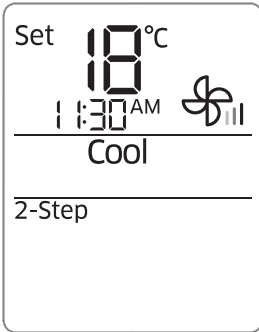

### 2-Step cooling function

Use the 2-Step cooling function to quickly reach the set temperature. The air conditioner automatically adjusts the fan speed and air flow direction. You can select this function only when the Cool mode is running.

In the Cool mode ▶ ▶ ▶

Select 2-Step. ▶

## Dehumidifying Operation

The dehumidifying function of the Samsung air conditioner keeps an enclosed space dry and comfortable.

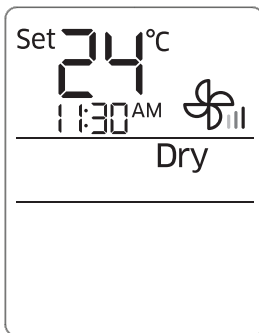

### Dry mode

Use the Dry mode in rainy or humid weather.

▶ ▶ Select Dry.

#### NOTE

- The lower the set temperature is, the greater the dehumidifying capacity is. When the current humidity seems to be high, adjust the set temperature to a low temperature.
- You cannot use the Dry mode for heating. The Dry mode is designed to produce a cooling side-effect.



# Air Purifying Operation

The air purification function of the Samsung air conditioner keeps the air in an enclosed space purified.

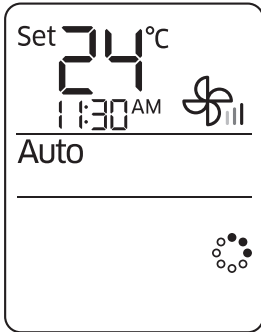

## Virus doctor function

Use the Virus doctor function to purify your room with positive ions produced by the air conditioner. This function is available in the Auto, Dry, Fan, and Heat modes.

In the Auto, Cool, Dry, Fan, or Heat mode ▶ (Options) ▶ (Left Arrow) (Right Arrow) ▶

Select (Virus Doctor Icon) ▶ (SET)

### NOTE

- When the Virus doctor function starts, the Virus doctor lamp turns on automatically.
- You can adjust the set temperature, except for in the Fan mode.
- When the Virus doctor function is additionally selected while a specific mode is running, there is little difference in electricity consumption and operating noise.

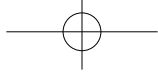

# Heating Operation

The heating functions of the Samsung air conditioner keep an enclosed space warm and comfortable.

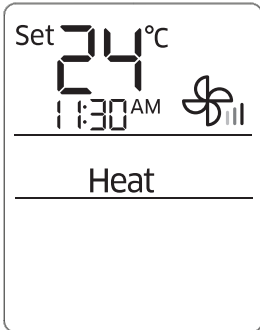

## Heat mode

Use the Heat mode to stay warm.



### NOTE

- While the air conditioner warms up, the fan may not operate for about 3 to 5 minutes at the beginning to prevent cold blasts.
- If the air conditioner heats insufficiently, use an additional heating appliance in combination with the air conditioner.
- When the outdoor temperature is low and the humidity is high in Heat mode, frost may develop on the outdoor heat exchanger. This may also decrease the heating efficiency. If this occurs, the air conditioner runs the defrost function for 5 to 12 minutes to remove frost from the outdoor heat exchanger.
- When the defrost function is running, steam is produced on the outdoor unit. The air conditioner moves the vertical air flow blade to the lowest position, as shown in the left figure, to prevent cold air from coming out from the indoor unit.

A. The position of the vertical air flow blade when the defrost function is running (The blade looks almost closed.)

B. The position range of the vertical air flow blade when the Heat mode is running.

- When the defrost function is running, no air comes out from the indoor unit in order to prevent cold air from coming out. When the defrost function is finished, warm air comes out after a while.
- The cycle of the defrost function may be shortened depending on the amount of frost on the outdoor unit.
- The cycle of the defrost function may be shortened depending on the humidity from rain and snow, too.
- When the defrost function is running, you cannot select other functions with the remote control. Select them after the defrost function is finished.

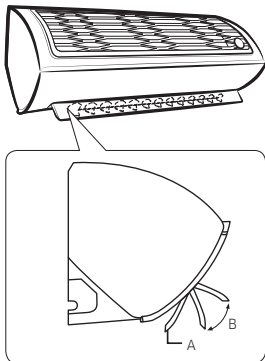

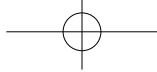

# Quick Smart Features

There is a variety of extra functionality provided by the Samsung air conditioner.

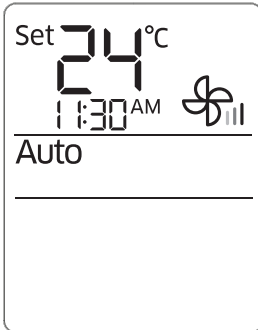

## Auto mode

Use the Auto mode when you want the air conditioner to automatically control the operation. The air conditioner will provide the most comfortable atmosphere that it can.



### NOTE

- When the indoor temperature seems to be higher or lower than the set point, the air conditioner automatically produces either cool air to cool down the indoor temperature or warm air to warm up the indoor temperature.

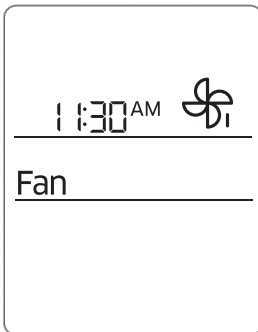

## Fan mode

Use the Fan mode to run the air conditioner like a common fan. The air conditioner provides a natural breeze.



### NOTE

- If the air conditioner will not be used for an extended period of time, dry the air conditioner by running it in the Fan mode for 3 or 4 hours.
- The outdoor unit is designed not to operate in the Fan mode to prevent cold air from entering through the unit. This is a normal operation and not a fault with the air conditioner.

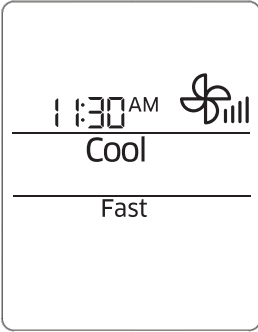

### Fast function

Use the Fast function to quickly cool or heat your room. This function is the most powerful cooling and heating function provided by the air conditioner. You can select this function both in the Cool and Heat modes.

In the Cool or Heat mode ▶  ▶   ▶

Select Fast. ▶ 

#### NOTE

- If you select the Fast function while such functions as 2-Step cooling, Comfort, Single user, Quiet, or good'sleep are running, these functions are cancelled.
- You can change the air flow direction.
- You cannot change the set temperature and the fan speed.
- When you select the Fast function in the Heat mode, you may not be able to increase the fan speed in order to prevent cool air from blowing.

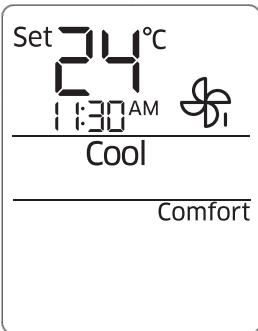

### Comfort function

Use the Comfort function when you feel the current cooling or heating effect is too strong. The air conditioner provides a mild cooling or heating. You can select this function both in the Cool and Heat modes.

In the Cool or Heat mode ▶  ▶   ▶

Select Comfort. ▶ 

#### NOTE

- You can change the set temperature and the air flow direction.
- You cannot change the fan speed.
- If you select the Comfort function while such functions as 2-Step cooling, Fast, Single user, Quiet, or good'sleep are running, these functions are cancelled.
- If you feel cooling or heating effect in the Comfort function is weak, cancel the Comfort function.

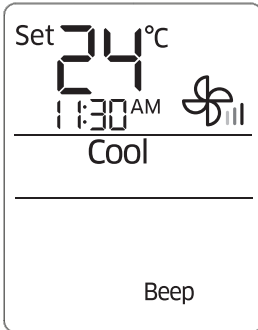

### Beep sound function

Use the Beep sound function to turn on or off the beep sound that plays when you press a button on the remote control.

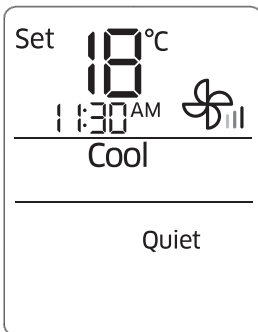

### Quiet function

Use the Quiet function to reduce operating noise. You can select this function both in the Cool and Heat modes.

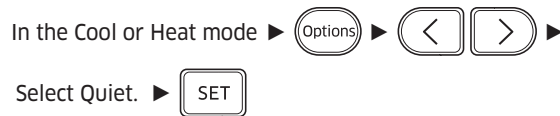

#### NOTE

- You can change the set temperature and the air flow direction.
- You cannot change the fan speed.
- If you select the Quiet function while such functions as 2-Step cooling, Fast, Comfort, Single user, or good'sleep are running, these functions are cancelled.

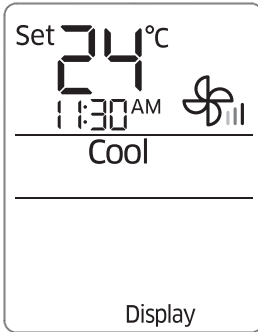
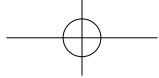

## Display lighting function

Use the Display lighting function to turn on or off the lighting of the indoor unit display.



### NOTE

- The Display lighting function does not operate when the indoor unit is turned off.
- If you turn off the Display lighting function while the Virus doctor function is running, the Virus doctor lamp also turns off.
- The Timer (⌚) indicator does not disappear, even if you turn off the Display lighting function.
- If you change the current mode or function when the Display lighting function is on, the Display lighting function turns off.

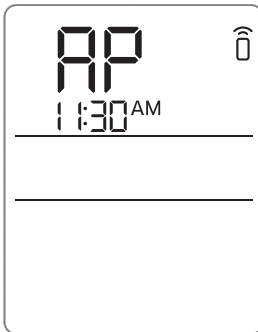

## Wi-Fi function (Smart A/C application)

When you turn on the Wi-Fi function, the Transmit (⊞) indicator blinks and **AP** appears on the remote control display for a few seconds. Then both of them disappear.



### NOTE

- For further information, refer to the Smart A/C application manual.
- Smart A/C application may not be available on some models.





# Energy-Saving Operation

The smart energy-saving functions of the Samsung air conditioner reduce electricity consumption.

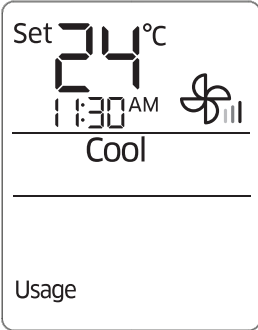

## Electricity consumption check

Use the Usage function to check the amount of electricity consumed by using the air conditioner. The amount consumed is displayed on the indoor unit display for a few seconds, and the set indoor temperature appears.

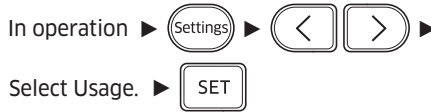

The value range displayed is between 0.1 kWh and 99 kWh. Electricity consumption is calculated from the moment the air conditioner turns on. The value is reset when the air conditioner turns off.

### NOTE

- The usage shown on the indoor unit display may slightly differ from the amount of electricity actually consumed.
- You can view electricity consumption only when the air conditioner is operating.



If using a multi system, this function is not supported.

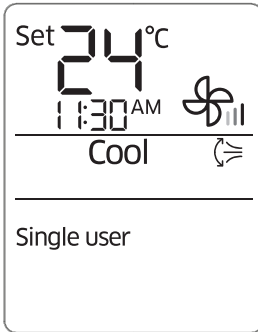

## Single user function

Use the Single user function to reduce electricity consumption while staying cool or warm. You can select this function in the Cool and Heat modes.

In the Cool or Heat mode ▶ ▶ ▶

Select Single user. ▶

### NOTE



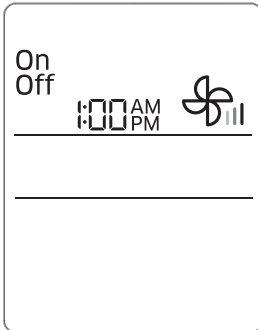

- When the Single user function starts, the pattern appears on the remote control for a few seconds, and vertical air swing begins automatically.
- If you select the Single user while such function as 2-Step cooling, Fast, Comfort, Quiet, or good'sleep are running, these modes are cancelled.
- After selecting the Single user function, you can change the set temperature (24 °C to 30 °C in the Cool mode, 16 °C to 30 °C in the Heat mode), fan speed, and vertical air flow direction.
- When the Single user function is turned on in the Cool mode while the set temperature is set to lower than 24 °C, the set temperature is automatically raised to 24 °C. But if the set temperature is set to between 25 °C and 30 °C, it remains the same.
- Even after you turn off the Single user function, vertical air swing continues until you turn it off with the Vertical air swing button.





## Timed on/Timed off function

Use the Timed on/Timed off to turn on or off the air conditioner after the time that you set.

- Check the current time on the remote controller before using this function.
- The default time is 1AM on the remote controller. The current time is reset to default time after changing the batteries.

 (Select On or Off among On, Off, and ) ▶  
  (Set the on/off time.) ▶ 

- Press the  (Timer) button to change the current function between **On**, **Off**, and  (good'sleep).  
 (good'sleep) is displayed in the Cool and Heat modes only.





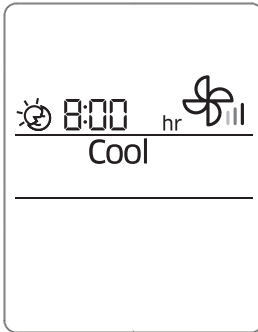
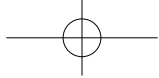

### NOTE



- You can set the time in hourly units from 1 hour ~ 12 hours according to AM, PM and in minute units from 0 ~ 59 minutes. Set the time interval to --:-- to cancel the Timed on/off function.
- Once you start the Timed on/off function, the Timer () indicator is displayed on the indoor unit display.
- After starting the Timed on function, you can change the mode and the set temperature. You cannot change the set temperature while the Fan mode is running.
- You cannot set the same time for both of the Timed on and Timed off functions.



## good'sleep function

Use the good'sleep function to get a good sleep at night and to save energy. You can select this function both in the Cool and Heat modes.

In the Cool or Heat mode ►  (Select  among On, Off, and )  
  (Set the operation time.) ► 

- Press the  (Timer) button to change the current function between On, Off, and  (good'sleep).

### NOTE

- You can adjust the set temperature by 1 °C between 16 °C and 30 °C .
- The recommended and optimal set temperatures in the good'sleep function are as follows:

Mode	Recommended set temperature	Optimal set temperature
Cool	25 °C to 27 °C	26 °C
Heat	21 °C to 23 °C	22 °C

- Once you start the good'sleep function, the Timer  indicator appears on the indoor unit display.
- You can set the time in half hour unit from 30 minutes ~ 3 hours and hour unit from 3~12 hours. Set the operation time to --:-- to cancel the good'sleep function.
- The default operation time for the good'sleep function is 8 hours. If the operation time is set to over 5 hours, the Wake up function begins 1 hour before the set time. The air conditioner stops automatically when the operation time expires.
- When the Timed on, Timed off, and good'sleep functions are overlapped, the air conditioner operates its timer with only the function that you have started most recently..

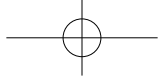

# Cleaning at a Glance

## Running Auto clean

Cleaning duration (minutes)	
Auto (Cool), Cool, Dry	30
Auto (Heat), Heat, Fan	15

### NOTE

- When you set the Auto clean timer, **Clean** blinks and then disappears on the remote control display. The Timer (⌚) indicator also appears on the indoor unit display.
- When the air conditioner is off, Auto clean starts immediately when it is selected. When the air conditioner is on, Auto clean starts as soon as the air conditioner stops running.
- During Auto clean, the indoor fan continues to run, and air flow blades remain open to expel ambient air.

## Cleaning the indoor unit exterior and outdoor unit heat exterior

Soft brush  
Tepid damp cloth

Before cleaning, be sure to turn off the equipment and disconnect the power plug.

Spray water to clean the dust.

### CAUTION

- Do not clean the display by using alkaline detergent.



- Do not use sulphuric acid, hydrochloric acid, or organic solvents (such as thinner, kerosene, and acetone) to clean the surfaces. Do not put any stickers on it as this can damage the surface of the air conditioner.
- When you clean and inspect the heat exchanger on the outdoor unit, contact the local service centre for help.
- Make sure to prevent any injury from sharp edges of the surface when handling the heat exchanger.

### Cleaning the filter

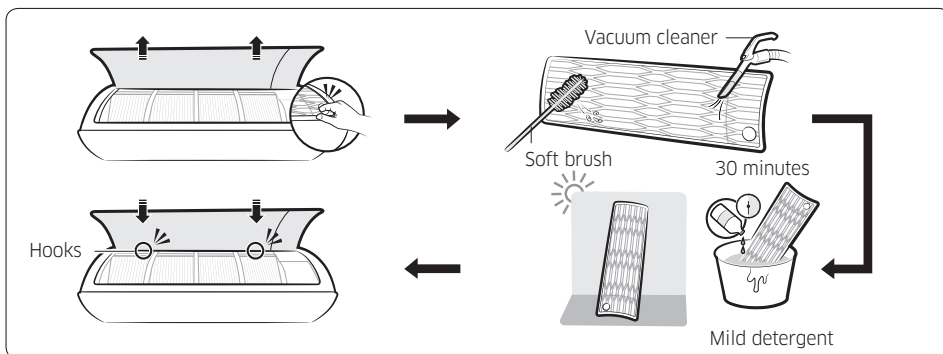

### **⚠ CAUTION**

- Do not scrub the air filter with a brush or other cleaning utensil. This may damage the filter.
- Do not expose the air filter to direct sunlight when drying it.

### **📖 NOTE**

- Clean the air filter every 2 weeks. Cleaning term may vary depending on the usage and environmental conditions.
- If the air filter dries in a humid area, it may produce offensive odours. Clean it again and dry it in a well-ventilated area.



## Resetting the filter-cleaning reminder

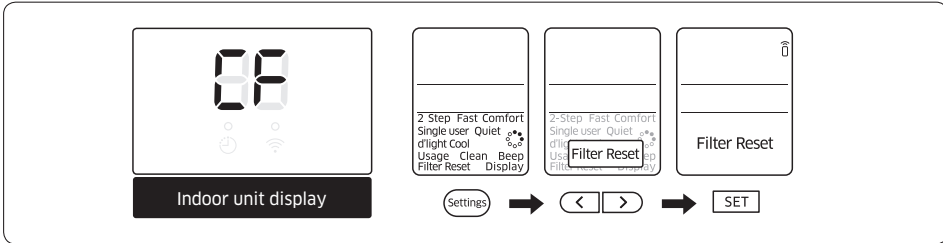

## Troubleshooting

If the air conditioner operates abnormally, refer to the following chart to save time and unnecessary expenses.

Problem	Solution
The air conditioner does not work at all.	<ul style="list-style-type: none"> <li>• Check the power status, then operate the air conditioner again.</li> <li>• Switch on the circuit breaker, plug in the power cord, then operate the air conditioner again.</li> <li>• Make sure that the isolator is turned on.</li> <li>• Check whether the Timed off function is running. Operate the air conditioner again by pressing the Power button.</li> <li>• Push down the Grille Door manually, maybe the Grille Door's stepping motor has problem. And Check the display, if error indicator appears, the air conditioner has another problem also. Contact the nearest service center.</li> </ul>

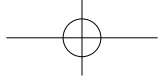

Problem	Solution
<b>I cannot change the temperature.</b>	<ul style="list-style-type: none"><li>• Check whether the Fan or Fast mode is running. In these modes, the air conditioner controls the set temperature automatically, and you cannot change the set temperature.</li></ul>
<b>Cool or warm air does not come out of the air conditioner.</b>	<ul style="list-style-type: none"><li>• Check whether the set temperature is higher in the Cool mode or lower in the Heat mode than the current temperature. Press the Temperature button on the remote control to change the set temperature.</li><li>• Check whether the air filter is blocked with dirt. If the air filter is blocked, the cooling and heating performance may decrease. Remove dirt regularly.</li><li>• Check whether the outdoor unit is covered or installed near obstacles. Remove the coverings and obstacles.</li><li>• Check whether the air conditioner is running the defrost function. When ice forms in winter or the outdoor temperature is too low, the air conditioner runs the defrost function automatically. While this function is running, the indoor fan stops and warm air does not come out.</li><li>• Check whether doors or windows are open. This may cause poor cooling or heating performance. Close the doors and windows.</li><li>• Check whether the air conditioner is turned on immediately after the cooling or heating operation stops. In this case, only the fan runs to protect the outdoor unit compressor.</li></ul>



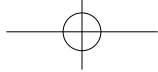

Problem	Solution
Cool or warm air does not come out of the air conditioner.	<ul style="list-style-type: none"> <li>• Check whether the pipe length is too long. When the pipe length exceeds the maximum pipe length, the cooling and heating performance may decrease.</li> </ul>
I cannot change the air flow direction.	<ul style="list-style-type: none"> <li>• Check whether the good'sleep function is running. While this function is running, you cannot control the air flow direction. (But you can control the air flow direction if this function is running in the Heat mode.)</li> </ul>
I cannot change the fan speed.	<ul style="list-style-type: none"> <li>• When the Auto, Dry, or Fast mode is running or the good'sleep function is running in the Cool mode, the air conditioner controls the fan speed automatically and you cannot change the fan speed.</li> </ul>
The remote control does not work.	<ul style="list-style-type: none"> <li>• Replace the batteries in the remote control with new ones.</li> <li>• Make sure that nothing is blocking the remote control sensor.</li> <li>• Check whether there are strong lighting apparatus near the air conditioner. Strong light which comes from fluorescent bulbs or neon signs may interrupt the electric waves.</li> </ul>
The Timed on/off function does not work.	<ul style="list-style-type: none"> <li>• Check whether you pressed the SET button on the remote control after setting the time.</li> </ul>

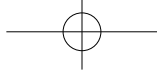

Problem	Solution
The indicator blinks continuously.	<ul style="list-style-type: none"><li>• Press the Power button to turn off the air conditioner or disconnect the power plug. If the indicator is still blinking, contact the service centre.</li></ul>
Odours permeate in the room during operation.	<ul style="list-style-type: none"><li>• Check whether the air conditioner is running in a smoky area. Ventilate the room or operate the air conditioner in the Fan mode for 3 to 4 hours. (There are no components used in the air conditioner that emit a strong odour.)</li><li>• Check whether the drains are clean. Clean them regularly.</li></ul>
An error is indicated.	<ul style="list-style-type: none"><li>• If the indoor unit indicator blinks, contact the nearest service centre. Be sure to pass the error code to the service centre.</li></ul>
Noise is generated.	<ul style="list-style-type: none"><li>• When refrigerant flow changes, noise may be generated, depending on the status of the air conditioner. This is a normal operation.</li></ul>
Smoke is generated from the outdoor unit.	<ul style="list-style-type: none"><li>• If may not be a fire but it can be a steam generated from the outdoor heat exchanger while the defrost function is running in the Heat mode in winter.</li></ul>
Water drops from the pipe connections of the outdoor unit.	<ul style="list-style-type: none"><li>• Condensation may develop when the ambient temperature changes excessively. This is a normal operation.</li></ul>